

ASX-1

Encoding aviation altimeter with serial output and airspeed Indicator (ASI)

Operating Manual – English 1.06



Introduction

The ASX-1 altimeter/airspeed combo is a 2 1/4" instrument based on a precision altimeter and a wide range, sensitive airspeed indicator. The altimeter conforms to ANSI standard atmosphere rules from -1000 ft up to a maximum of 30 000 ft. The altimeter includes an encoding serial output that, when used in combination with MGL Avionics CNV-AT, provides a parallel Gillham code interface for transponders. The altimeter can display altitude in feet or meters. Local pressure can be set in millibars or inches of Mercury.

The airspeed indicator can show air speeds from 16 to 250 mph and is well suited for use in slow aircraft due to very good sensitivity and linearity at low air speeds. The airspeed indicator as well as altimeter can interface to a static port and the airspeed indicator is based on a standard aviation pitot tube. The airspeed indicator can be set to indicate speeds in statute miles per hour (mph), kilometers per hour (km/h) or nautical miles per hour (knots) with the air-distance being displayed in corresponding units. The airspeed sensitivity can be calibrated by the user to cater for errors caused by pitot tube placement. The ASX-1 also outputs airspeed information via the airtalk protocol for interfacing to the Infinity FF-1 / Velocity FF-3 (fuel flow computer for single or dual fuel tanks) and the SP-X (AHRS) instruments.

In addition the ASX-1 provides a 24 entry automatic flight log that stores the duration of each of the last 24 flights, an air-distance trip counter and a current flight timer. The ASX-1 is the ideal instrument for installations where panel space is limited.

1 Features

- Precision altimeter from -1000 ft up to a maximum of 30 000 ft (-304 to 9144m)
- Provides a parallel Gillham code interface for transponders when used in combination with the MGL Avionics CNV-AT
- The altimeter can display altitude in feet or meters. Local pressure can be set in millibars or inches of Mercury
- Airspeed ranges from 16 to 250mph and is well suited to slow aircraft due to very good sensitivity and linearity at low air speeds. Airspeed can be displayed as IAS or a calculation based TAS
- Includes a 24 entry automatic flight log
- Includes an air-distance trip counter and a flight timer
- Airspeed units can be in miles per hour (mph), kilometer per hour (km/h) or nautical miles per hour (knots)
- Contains a programmable low/high airspeed alarm
- Records maximum airspeed and altitude reached in permanent memory
- Standard 2 1/4" aircraft enclosure (can be front or rear mounted)
- Rotary control plus 2 independent buttons for easy menu navigation and user input
- Alarm output as well as a red LED illuminates when the alarm has been activated
- Large backlit graphic LCD with adjustable contrast
- Wide input supply voltage range of 8 to 30V DC with built in voltage reversal and over voltage protection for harsh electrical environments
- Light weight design
- Field upgradeable firmware
- 1 year limited warranty

2 ASX-1 Layout

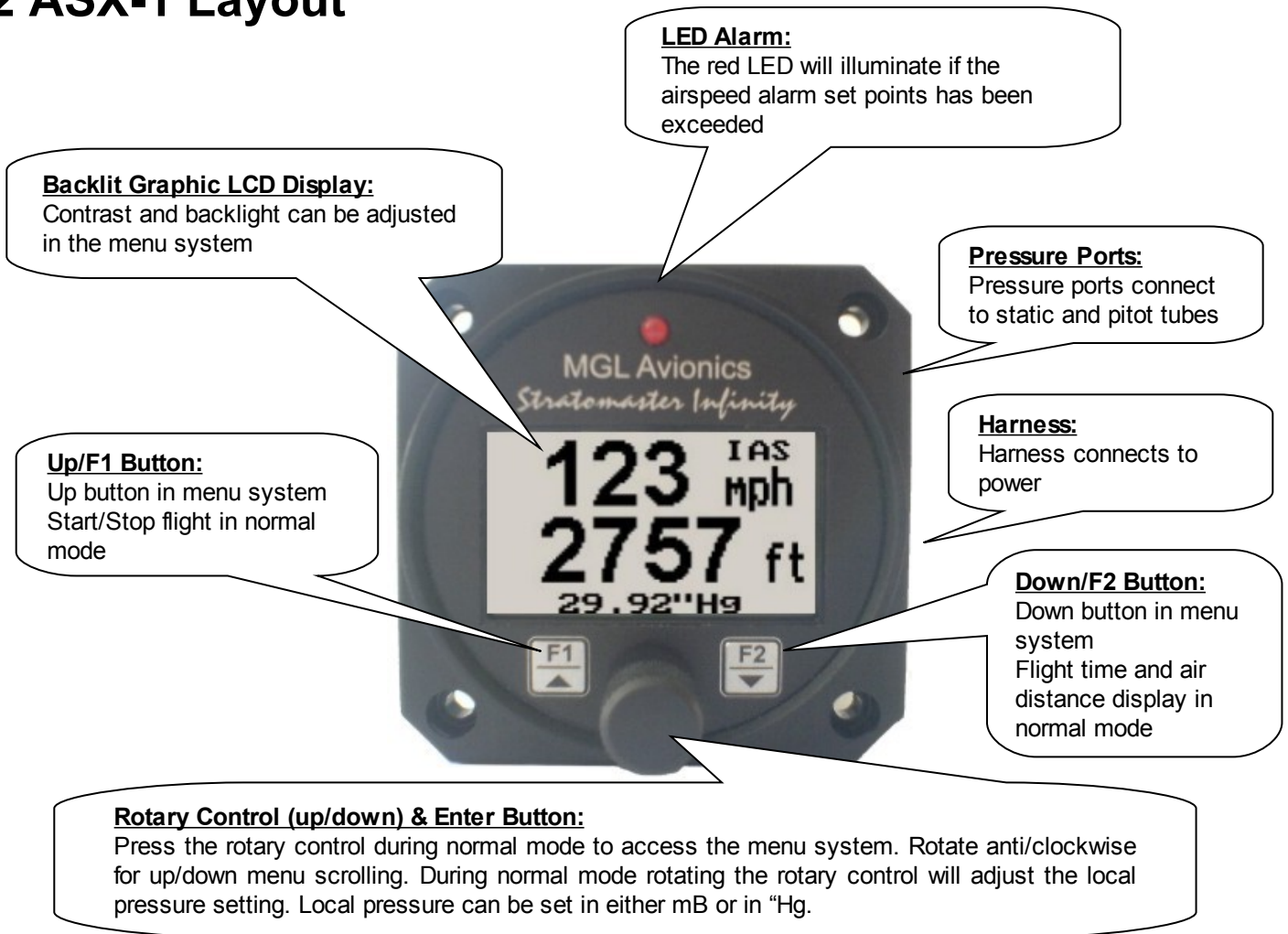

3 Main Display

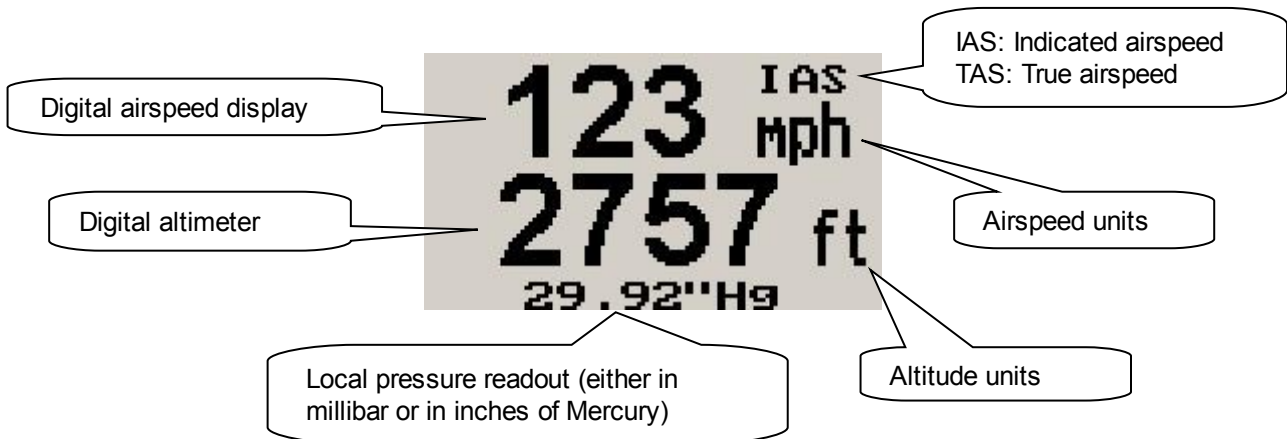

3.1 Start/Stop Flight display



Press the F1 key during the normal display mode to manually start/stop a flight. This key is only active if the ASX-1 is setup to select the manual flight option under the log book setup menu.

3.2 Flight time and air distance display

This display can be accessed by pressing the F2 key during the normal display mode. Use the up/down keys or the rotary control to select "reset air dist" to reset the air distance counter. The flight time is automatically reset when a new flight is started. The air distance trip counter can still be reset manually even if the pilot selects the automatic resetting of the air distance trip counter.



Note: The air distance trip counter measures distance flown through the air. This is not the same as distance flown over the ground unless you are flying at sea level at zero wind speed. The air distance shown is subject to under reading at altitude due to decreased air density.

4 Menu System

Pressing the rotary control button during the normal display mode will cause the ASX-1 to enter the menu system. Use the up/ down keys or the rotary control to navigate through the menu system.

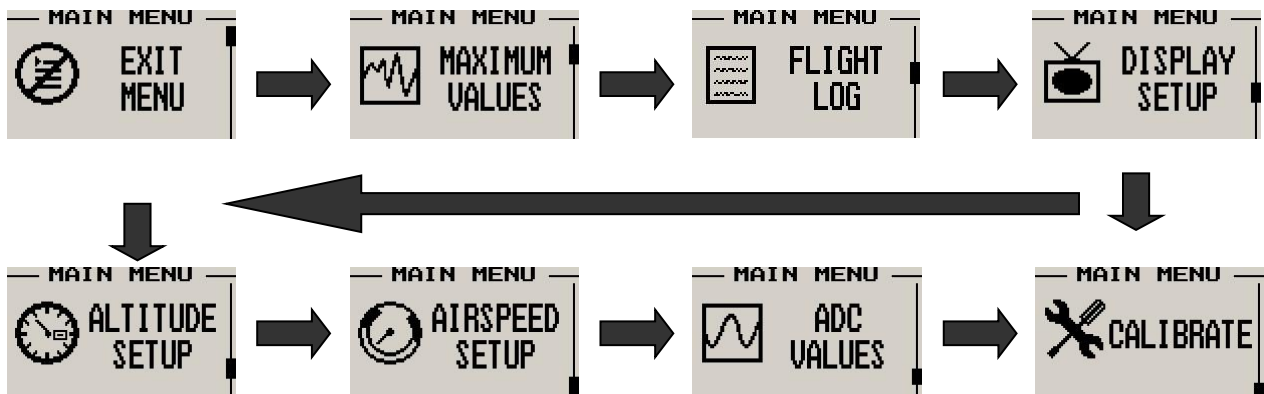

Note: (ADC Values and Calibrate Menus are only visible when powering up the unit and pressing the Rotary Control). The text “CALIBRATE” will appear on the intro screen when entering this mode.

Warning: The Calibrate Menu is for technical personnel only. Changing any values in this menu may cause the instrument to display incorrect information, and may require the instrument to be returned to the factory for recalibration.

4.1 Exit Menu



Pressing the rotary control on this menu item will cause the ASX-1 to exit the menu system. All changes made during navigation of menu system will be saved in non-volatile memory on exiting the menu system. If you remove power before exiting the menu the instrument will not save any changes.

4.2 Maximum Values



To avoid false recordings, the maximum values function is only activated 10 seconds after the instrument has powered up.



Move the highlight over the “DONE” menu item and press the rotary button to return to the main menu.



Move the highlight over this menu item and press the rotary button to reset the maximum altitude and airspeed values to the current values.

4.3 Flight Log



The ASX-1 uses the following algorithm to determine if a flight is in progress (Detect Mode):
 If airspeed is greater than the preset flight take off airspeed for the duration of 60 seconds or more, a flight is started with a logbook entry. The flight ends if airspeed falls below the preset flight take off airspeed for 30 continuous seconds. During a flight the logbook cannot be viewed.

The above algorithm ensures that touch-and-goes will not result in the end of a flight and a logbook entry. Should the instrument be switched off during a flight, this will end the flight and the log will reflect the time until the instrument was switched off. Should the instrument be switched on again during a flight, a new flight will start for logging purposes.



Move the highlight over this menu item and press the rotary button to return to the main menu.

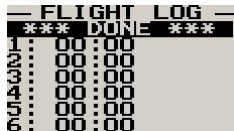
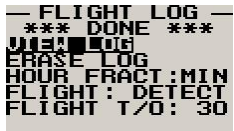

Select this function to view the flight log. The flight log contains the duration of each of the last 24 logged flights. Duration is displayed in hours and minutes. Eight flights are displayed at a time, Use the up/down or the rotary control to navigate through the log. Empty log entries are shown as "--:--".

Note: You cannot view the flight log while a flight is in progress.



Pressing the F1 key will erase all the flight log entries.



Select if you would like the hour to be displayed in decimal fractions (0-99) or minutes (0-59). This setting influences the current flight time display and the flight log.



Select whether you want the ASX-1 to automatically detect a flight or whether the pilot must press the F1 key to start/stop a flight.



This menu item is only shown if the "detect" flight mode is selected. Enter the airspeed that you want a flight log entry to start.

4.4 Display Setup



Move the highlight over the "DONE" menu item and press the rotary button to return to the main menu.

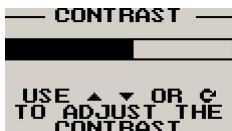

Select this menu option to adjust the display contrast.



Select this menu option to turn the backlight on and off.

4.5 Altitude Setup



Move the highlight over this menu item and press the rotary button to return to the main menu.

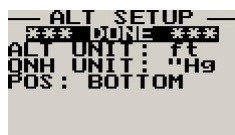

Select if you want your altitude readout in feet (ft) or meters (m).

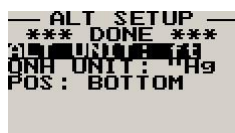

Select if you want your local pressure readout in millibars (mB) or inches of Mercury ("Hg).

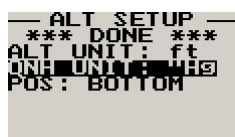

Select whether you want the altitude display on the top or on the bottom of the main display.



4.6 Airspeed Setup



All the airspeed parameters can be setup here.



Move the highlight over the "DONE" menu item and press the rotary button to return to the main menu.

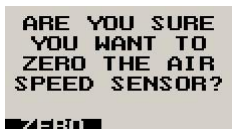

This setup allows your instrument to measure the zero airspeed reading of the airspeed sensor and set a calibration value internally for this. This is equivalent to some mechanical airspeed indicators that have an adjustment to set the needle to zero when the aircraft is not moving. You would use this function occasionally if you see an airspeed reading when the aircraft is at rest. This

may be caused by aging of the built in pressure sensor or related electronics. When you perform this function, make sure that no wind is blowing into the pitot tube as this would result in an incorrect internal calibration.

Pressing the F1 key will zero the airspeed sensor.



Enter whether you want the airspeed to display true airspeed (TAS) or indicated airspeed (IAS). Please see section 6 below for more information on true airspeed (TAS).

```

-- ASI SETUP --
*** DONE ***
ZERO ASI
ASI DISP: IAS
LOW ALARM: 30
LOW ALM: ON
HIGH ALARM: 80
HIGH ALM: ON
    
```

Enter the low airspeed set-point for when the alarm must activate. Any speed below this value will activate the alarm.

```

-- ASI SETUP --
*** DONE ***
ZERO ASI
ASI DISP: IAS
LOW ALARM: 30
LOW ALM: ON
HIGH ALARM: 80
HIGH ALM: ON
    
```

Select whether you want the low air speed alarm to be turned on or off. The low airspeed alarm is only activated once a flight has started.

```

-- ASI SETUP --
*** DONE ***
ZERO ASI
ASI DISP: IAS
LOW ALARM: 30
LOW ALM: ON
HIGH ALARM: 80
HIGH ALM: ON
    
```

Enter the high airspeed set-point for when the alarm must activate. Any speed above this value will activate the alarm.

```

-- ASI SETUP --
*** DONE ***
ZERO ASI
ASI DISP: IAS
LOW ALARM: 30
LOW ALM: ON
HIGH ALARM: 80
HIGH ALM: ON
    
```

Select whether you want the high air speed alarm to be turned on or off.

```

-- ASI SETUP --
ZERO ASI
ASI DISP: IAS
LOW ALARM: 30
LOW ALM: ON
HIGH ALARM: 80
HIGH ALM: ON
ASI UNIT: KNOTS
    
```

Select the ASI unit of preference. You can select statute miles, kilometers or nautical miles. According to this selection your airspeed will be indicated in mph, km/h or knots.

```

-- ASI SETUP --
ASI DISP: IAS
LOW ALARM: 30
LOW ALM: ON
HIGH ALARM: 80
HIGH ALM: ON
ASI UNIT: mph
ASI FILT: FAST
    
```

This function can be used to select the signal filter time constant. Selections are “fast” or “slow”. This selection influences the rate at which your ASI can change its reading. If you have an installation that suffers from strong turbulence at the pitot tube, select “slow”. If you have a very clean airflow in front of the pilot tube you can select “fast” which will give you a faster response to airspeed changes.

```

-- ASI SETUP --
LOW ALARM: 30
LOW ALM: ON
HIGH ALARM: 80
HIGH ALM: ON
ASI UNIT: mph
ASI FILT: FAST
DIST ZERO: MAN
    
```

Select if you want the air-distance counter to reset automatically at the start of a flight or if you want to reset it manually only.

Note: You can reset the air distance counter at any time regardless of this setting.

```

-- ASI SETUP --
LOW ALM: ON
HIGH ALARM: 80
HIGH ALM: ON
ASI UNIT: mph
ASI FILT: FAST
DIST ZERO: MAN
POS: TOP
    
```

Select whether you want the airspeed display on the top or on the bottom of the main display.

4.7 ADC Values

```

-- MAIN MENU --
[Waveform Icon] ADC
VALUES
    
```

Note: This menu item is for technical personnel only, and is not displayed during the normal operation of the instrument. Please see section 4 above on how to access this menu item.

```

-- ADC VALUES --
*** DONE ***
ALTITUDE: 2853
ASI: 1220
    
```

This menu displays the ADC values that have been read from the pressure sensors.

4.8 Calibrate

```

-- MAIN MENU --
[Wrench Icon] CALIBRATE
    
```

Note: This menu item is for technical personnel only, and is not displayed during the normal operation of the instrument. Please see section 4 above on how to access this menu item. Consult your local dealer or factory before entering this menu.

```

CALIBRATE
*** DONE ***
ALT: +0 3867
ASI: +100% 135

```

Move the highlight over this menu item and press the rotary button to return to the main menu.

```

CALIBRATE
*** DONE ***
ALT: +0 3867
ASI: +100% 135

```

On the back of the ASX-1 you will find the calibration number that has been determined to result in the most accurate reading of your altimeter. This is the value that should be entered here. Should you have access to an accurate reference you may use this function to calibrate your altimeter. Before you do this, ensure that you have your local pressure set to coincide with a calibrated and certified reference. Your altimeter has been calibrated by the factory to an accuracy of +/- one mB or approximately +/- 30 ft (10m).

```

CALIBRATE
*** DONE ***
ALT: +0 3867
ASI: +100% 135

```

This function is used to calibrate your airspeed indicator. During the factory calibration a factor has been determined and entered here that will give you accurate airspeed provided your pitot tube is not influenced by pressure effects caused by airflow around your airframe. The calibration works in % of the reading and you can increase or decrease the reading if required to help cancel out under or over reading of the airspeed indicator on your aircraft. The original calibration factor has been written onto the back of your instrument.

5 Altitude Encoder

To use the ASX-1 as an encoding altimeter an Airtalk to parallel Gillham code output encoder such as the MGL Avionics CNV-AT must be used. This converter takes the Airtalk serial string that is outputted by the ASX-1 and converts it to a parallel Gillham code suitable for aircraft transponders. Please see the CNV-AT operating manual for more information.

6 True airspeed (TAS)

TAS is indicated airspeed corrected for air density. As air density decreases with altitude, an airspeed indicator will under read at altitude. This error can be appreciable, for example at an altitude of 5 000 ft (1 524 m) errors of 5% to 10% are possible depending on local weather and temperature conditions. As you increase the altitude the error gets larger quickly. Setting your instrument to read TAS will correct for this error based on the pressure altitude reading, taking your current QNH setting into account. The result of this is an airspeed reading that can be as accurate as 1%, depending mainly on the errors introduced by the airflow around your aircraft and pitot tube.

How is TAS calculated? Often pilots ignore the effect of temperature and only take altitude into account when converting ASI to TAS. For practical purposes this is quite accurate and gives a good reflection on your true airspeed. Keeping in mind that ASI measurement is subject to errors caused by airflow around your aircraft, there seems little point in taking this calculation to absolute resolution. Again, we have decided to use a formulae often used by pilots. This way the instrument reading will agree with what pilots are used to.

Based on Worthington's 13th edition page 349:

Add 1.75% of indicated airspeed (IAS) per 1000 ft (304.9 m) increase in altitude above sea level.
We assume here that IAS = RAS (rectified air speed).

Warning when using TAS: Your aircraft's stall, rotation and approach speeds are based on sea-level ASI indication. Should you use TAS indication at altitude you must correct for the reduced ambient pressure effects on the control and flight surfaces of your aircraft. Should you fail to do so you will endanger your flight by flying too slowly for prevailing conditions. Always use the ASI indication to determine your rotation or approach speeds.

7 Loading factory default settings

Pressing and holding the F1 and F2 simultaneously on power up will cause the ASX-1 to load preprogrammed factory default settings. The following screen will be displayed:

LOADING
DEFAULT
SETTINGS

8 Operating the alarms

If the alarm is activated, the corresponding item on the display will flash. At the same time the externally available alarm switch will close. The switch will remain closed until any button is pressed to acknowledge the alarm or until the condition(s) that activated the alarm no longer exist. The alarm output can be used to switch an external alarm indicator. The external alarm switch is an open collector transistor switch to ground with a maximum rating of 0.5A DC. It is possible to wire the alarm contacts of several Stratomaster instruments in parallel should this be desired. To avoid false activation of the alarms, the alarm function is only active 10 seconds after the instrument has powered up.

9 Cleaning

The unit should not be cleaned with any abrasive substances. The screen is very sensitive to certain cleaning materials and should only be cleaned using a clean, damp cloth.

Warning: The ASX-1 is not waterproof, serious damage could occur if the unit is exposed to water and/or spray jets.

10 ASX-1 Specifications

Operating Temperature Range	-10°C to 50°C (14°F to 122°F)
Storage Temperature Range	-20°C to 80°C (-4°F to 176°F)
Humidity	<85% non-condensing
Power Supply	8 to 30Vdc SMPS (switch mode power supply) with built in 33V over voltage and reverse voltage protection
Current Consumption	Approx. 50mA @ 13.8V (backlight on) 16mA @13.8V (backlight off)
Display	114x64 graphic LCD display. Contrast and backlight is user configurable, green/yellow backlight
ADC	12bit over sampled successive approximation
Dimensions	see Infinity series dimensional drawing
Enclosure	2 1/4" ABS, black in color, front or rear mounting
Weight	Approx. 120 grams
Alarm contact current rating	Open collector transistor switch to ground. Maximum rating 0.5A DC
Non-volatile memory storage	100000 write cycles
Altimeter range	-1000ft to 30 000ft (-304m to 9144m)
Altimeter resolution	1ft/1m
Measurement accuracy	+/- 1mB, +/- 30ft at sea level
Airspeed range	16mph to 250mph
Airspeed resolution	1 mph
Measurement accuracy	+/-1% at 85mph nominal
Airtalk protocol	19200 baud, 8 data bits, no parity, 1 stop bit (TTL voltage levels)

11 Installation

Connect the static port to a suitable static air pressure line. If you have a slow aircraft or an aircraft where the internal cabin pressure does not change during flight and is equivalent to the outside air pressure you may find that it is not required to connect a static port. For installations in typical ultralight aircraft pods, be aware of possible pressure changes inside the pod during flight caused by ram air or suction effects. This may lead to a false indication of altitude and/or airspeed. Often these effects are dependent on the current angle of attack of the airflow around your pod. You will need to install a suitable static port in these cases. Connect your pitot tube to the "pressure port". Pitot tubes are found in a large variety at your aircraft parts shop, in mail order catalogs or you can make your own. Contrary to popular belief, pitot tubes are not carefully designed and calibrated, but are simple orifices or tubes that get pointed in the direction that you are flying. The forward movement of the aircraft causes air to dam inside the pitot tube. This increases the pressure inside the tube. Most small aircraft such as ultralights or microlights do not require a connection to a static port. In these cases, simply leave the static port open. Ensure however that the static port does not receive pressurized air due to the forward movement of the aircraft. Be especially critical of your pod or panel if you do not use a static port. Any build up of a pressure differential due to ram air or suction can lead to large errors of the indicated airspeed. Static ports are usually mounted at a strategic position on the rear side of the aircraft fuselage for faster, pressurized aircraft. Suitable pitot tubes can be made from a short piece of hollow aluminium or copper piping. Length and diameter are not important. Ensure that the front of the pitot tube has a suitable chamfer if you use thick walled tubing or you may introduce a speed reading error if you have a faster aircraft.

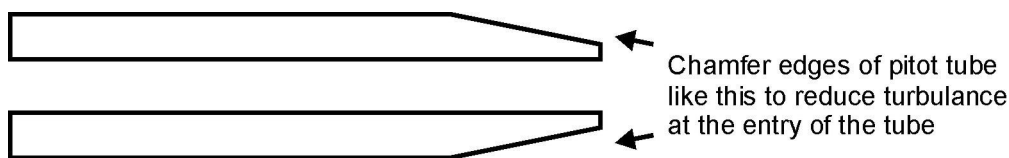

Example cross-section of thick walled pitot tube.

Suitable connection hose for both pitot tube and static port can be obtained from a hardware store or even a pet shop. Good quality tubing is often used for fish tanks and it has just the right diameter. Please note that this kind of tubing is not advised for pressurized aircraft. In this case you would need to obtain aircraft grade tubing of suitable diameter. You would also have to use hose clamps to fasten the hose onto the ASX-1 pitot and static ports. The ASX-1 allows you to calibrate the airspeed reading. This is done in the "Calibrate" menu item. The main reason for this is to be able to remove errors introduced due to the airflow around your aircraft which may have an effect of your pitot tube pressure.

11.1 ASX-1 DB9 Cable connections

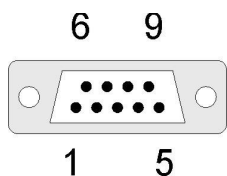

DB 9 Pin	Color	Function
1	Black	Ground
4	RCA (Inner cable)	Airtalk communication Used for firmware upgrading and interfacing to the FF-1/SP-X (Airtalk speed message) or the CNV-AT (Airtalk to parallel Gillham code output encoder)
6	Red	8-30Vdc power
9	White	Alarm Output

11.2 Connection Diagram

Connect static port to suitable static line on the aircraft. **Note:** Leaving this port unconnected may lead to airspeed and altitude errors as cabin pressure changes due to airflow or other factors. Connect the pressure port to a pitot tube. The location of the pitot tube should be chosen so it is exposed to clean, undisturbed airflow at the same speed as the aircraft if flying. Small errors related to location may be calibrated out using the ASI calibration function.

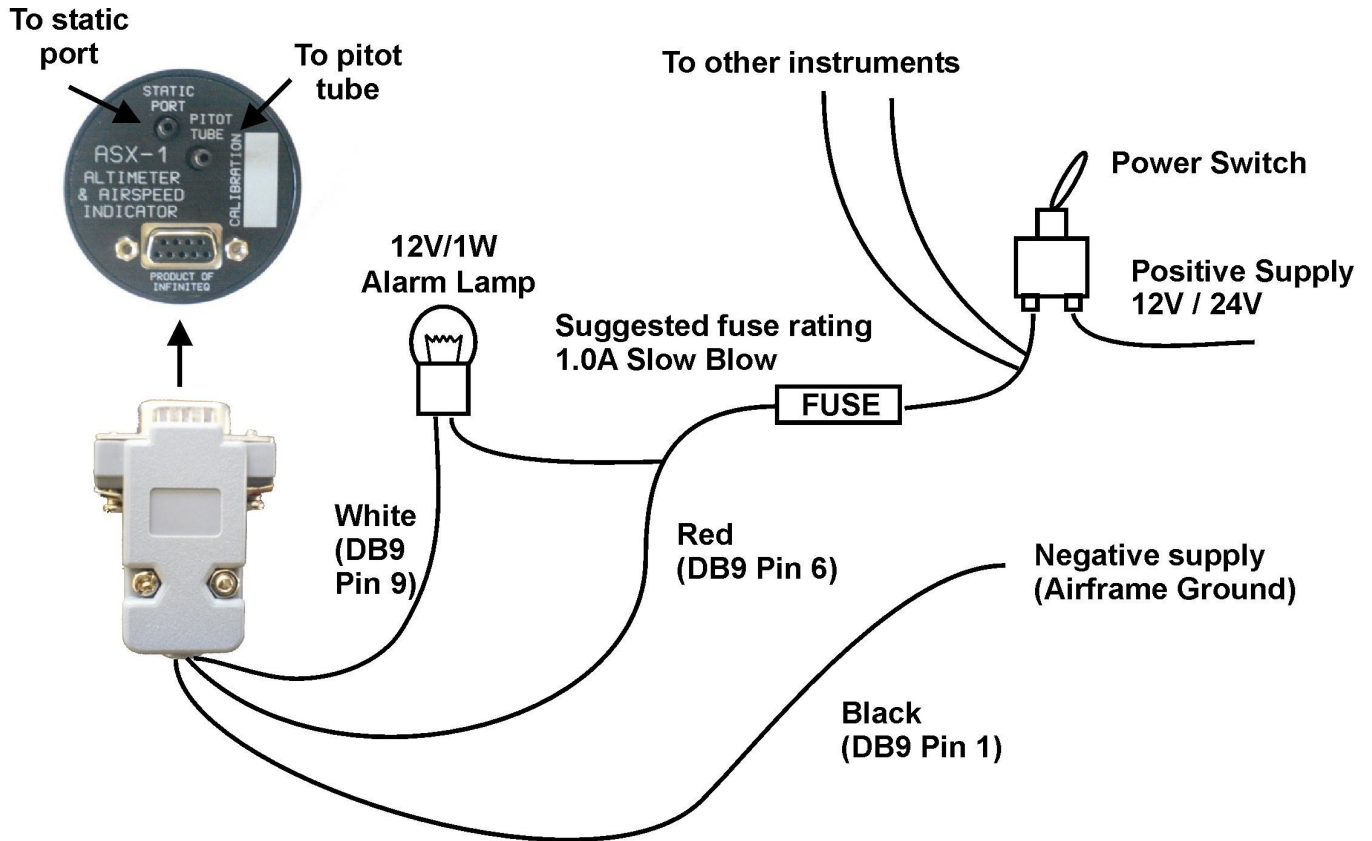

The use of an external 1A fuse is recommended. Connect the supply terminals to your aircrafts power supply. The ASI-1 can be used on both 12V and 24V without the use of any pre-regulators. Ensure that the supply voltage will not drop below 8V during operation as this may result in incorrect voltage and or current readings.

11.3 Pressure Port Dimensions

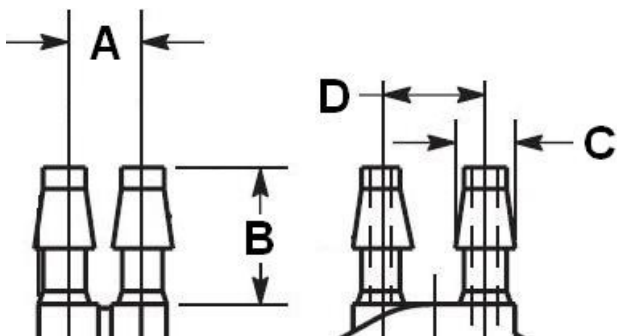

	Inches		Millimeters	
	Min	Max	Min	Max
A	0.248	0.278	6.30	7.06
B	0.420	0.440	10.67	11.18
C	0.182	0.194	4.62	4.93
D	0.310	0.330	7.87	8.38

12 Warranty

This product carries a warranty for a period of one year from date of purchase against faulty workmanship or defective materials, provided there is no evidence that the unit has been mishandled or misused. Warranty is limited to the replacement of faulty components and includes the cost of labour. Shipping costs are for the account of the purchaser.

Damage as a result of applying excessive pressure to the pressure ports are excluded from warranty.

Note: Product warranty excludes damages caused by unprotected, unsuitable or incorrectly wired electrical supplies and or sensors, and damage caused by inductive loads.

13 Disclaimer

Operation of this instrument is the sole responsibility of the purchaser of the unit. The user must make themselves familiar with the operation of this instrument and the effect of any possible failure or malfunction.

This instrument is not certified by the FAA. Fitting of this instrument to certified aircraft is subject to the rules and conditions pertaining to such in your country. Please check with your local aviation authorities if in doubt. This instrument is intended for ultralight, microlight, homebuilt and experimental aircraft. Operation of this instrument is the sole responsibility of the pilot in command (PIC) of the aircraft. This person must be proficient and carry a valid and relevant pilot's license. This person has to make themselves familiar with the operation of this instrument and the effect of any possible failure or malfunction. Under no circumstances does the manufacturer condone usage of this instrument for IFR flights.

The manufacturer reserves the right to alter any specification without notice.

Other instruments in the *Stratomaster Infinity* series

ALT-1	Precision encoding altimeter and vertical speed indicator
ALT-2	Precision encoding altimeter and vertical speed indicator with a serial RS232 transponder output
ASI-1	Airspeed indicator (ASI) with automatic flight log
ASX-1	Encoding aviation altimeter with serial output and airspeed indicator (ASI)
AV-1	Artificial horizon and magnetic compass indicator
BAT-1	Battery voltage and current monitor
E-3	Universal engine monitor
FF-1	Fuel Computer (single or dual fuel tanks)
GF-1	+/-10G tilt compensated dual range G-force meter
MAP-1	Manifold pressure and RPM Indicator
RV-1	Universal engine RPM and rotor RPM Indicator
RV-2	Universal turbine RPM / RPM factor display
RTC-2	Aviation real time clock (RTC) and outside air temperature (OAT) display
TC-1	4-Channel thermocouple indicator
TP-1	Universal temperature and pressure gauge