

**ENERGIZER L91**  
Ultimate Lithium

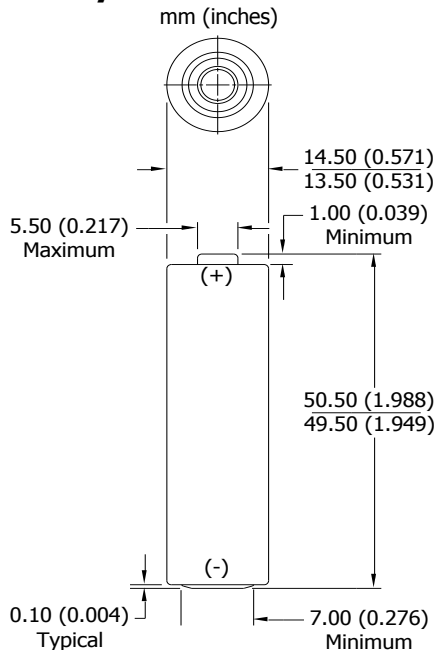



**AA**

**Industry Standard Dimensions**



**Specifications**

<b>Classification:</b>	"Cylindrical Lithium"
<b>Chemical System:</b>	Lithium/Iron Disulfide (Li/FeS <sub>2</sub> )
<b>Designation:</b>	ANSI 15-LF, IEC-FR6
<b>Nominal Voltage:</b>	1.5 Volts
<b>Compatible With:</b>	<a href="#">EA91</a> , <a href="#">E91</a> , <a href="#">NH15</a> , <a href="#">1215</a>
<b>Storage Temp:</b>	-40°C to 60°C (-40°F to 140°F)
<b>Operating Temp:</b>	-40°C to 60°C (-40°F to 140°F)*
<b>Typical Weight:</b>	14.5 grams (0.5 oz.)
<b>Typical Volume:</b>	8.0 cubic centimeters (0.49 cubic inch)
<b>Max Discharge:</b>	3.0 Amps Continuous
(single battery only)	5.0 Amps Pulse (2 sec on / 8 sec off)
<b>Max Rev Current:</b>	2 uA
<b>Lithium Content:</b>	Less than 1 gram
<b>Typical IR:</b>	60 to 210 milliohms (depending on method)
<b>Shelf Life:</b>	20 years at 21°C
<b>Shipping:</b>	<a href="#">Please refer to PSDS Document</a>
<b>Certifications:</b>	 This battery has Underwriters Laboratories component recognition (MH12454)  Certified for intrinsic safety to UL913 7th Ed., CAN/CSA-C22.2 No. 157-92

**\*All data shown tested at 21°C unless otherwise stated.**

**Milliamp-Hours Capacity**

Constant Current Discharge to 0.8 Volts

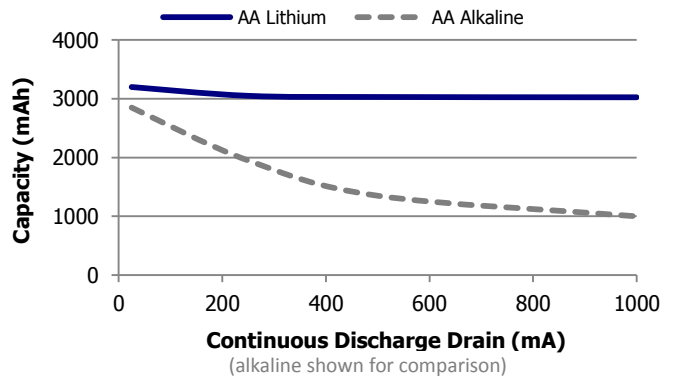

**Discharge Profile**

Constant Current Discharge

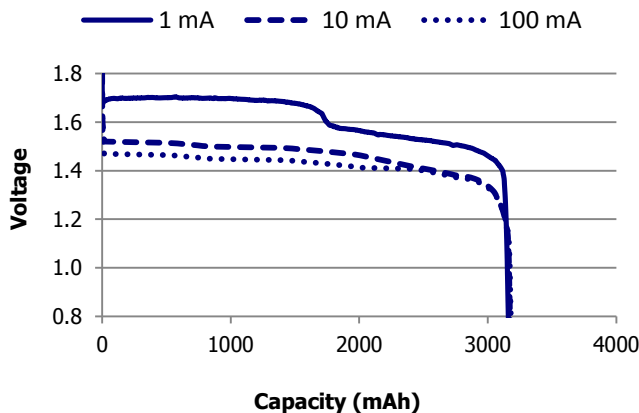

**Temperature Effects on Capacity**

Constant Current Discharge

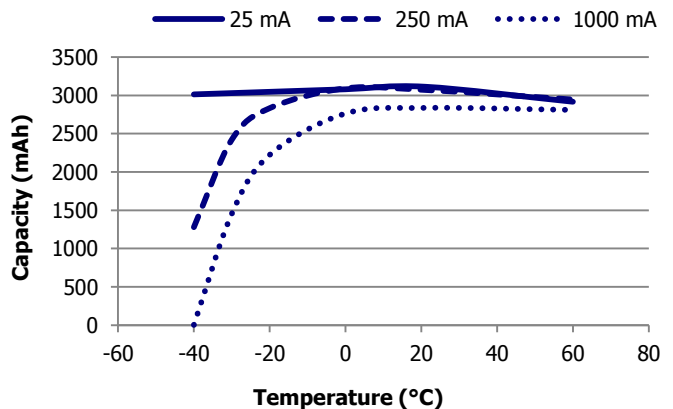

**Important Notice**

This datasheet contains typical information specific to products manufactured at the time of its publication.  
©Energizer Holdings, Inc. - Contents herein do not constitute a warranty.

# ENERGIZER L91

**AA**

## Internal Resistance Profile

Cell Ohmic Resistance - Dual Pulse Method

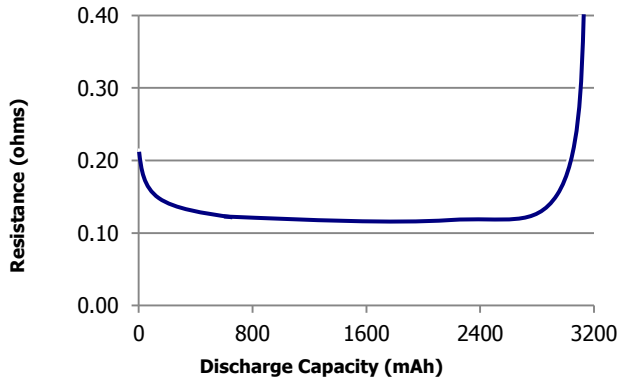

## Pulse Response

Open Circuit Voltage - 100/500/1k mA Pulse

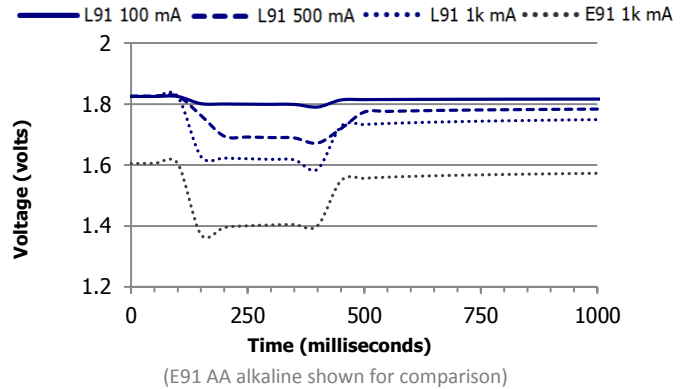

## Constant Power Performance

Typical Characteristics to 0.8 Volts

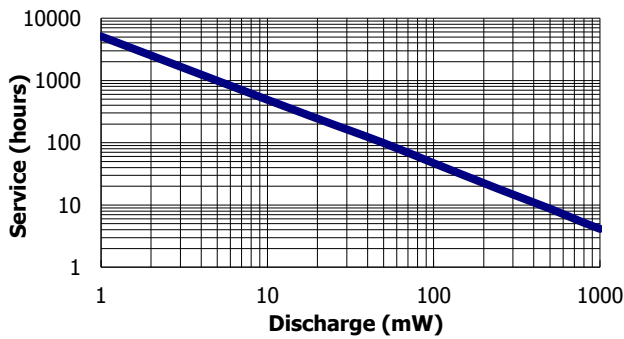

## Constant Current Performance

Typical Characteristics to 0.8 Volts

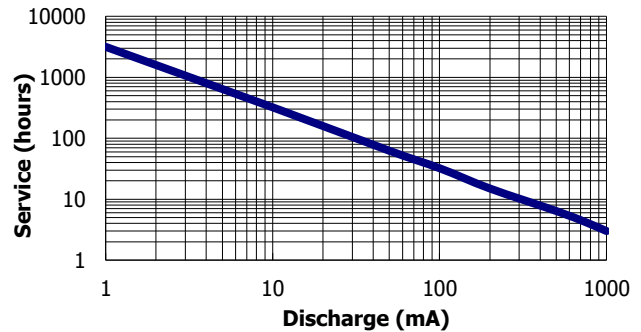

## Application Tests

**REMOTE** 24 ohm 15 sec/min 8 hrs/day  
**RADIO** 43 ohm 4 hrs/day

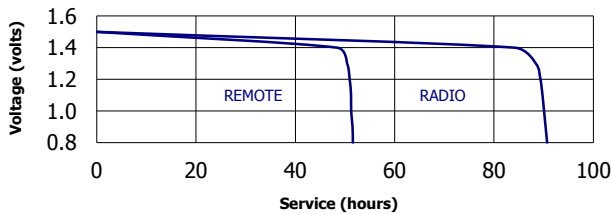

## Application Tests

**CD/GAMES** 250 mA 1 hr/day  
**DIGITAL AUDIO** 100 mA 1 hr/day

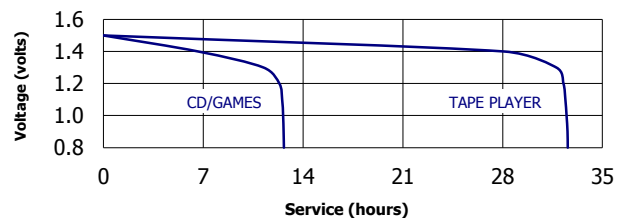

## Application Tests

**TOOTHBRUSH** 500 mA 2/13 min 24 hrs/day  
**PORTABLE LIGHTING** 3.3 ohm LIF  
**TOY** 3.9 ohm 1 hr/day

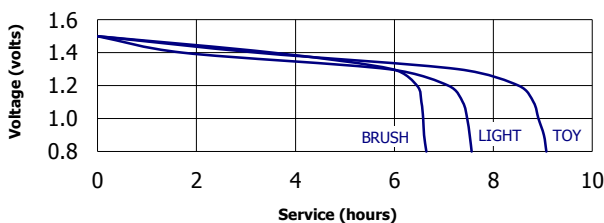

## Industry Standard Tests

**PHOTOFLASH** 1K mA 10 sec/min 1 hr/day  
**DIGITAL CAMERA** 1.5/.65K mW 2/.1/27.9s 10X

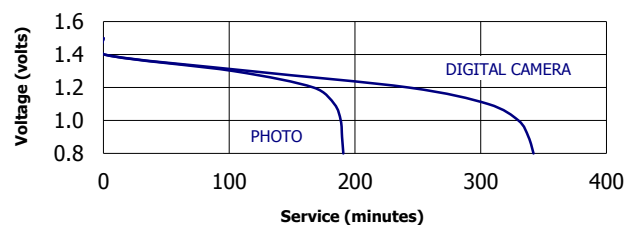

### Important Notice

This datasheet contains typical information specific to products manufactured at the time of its publication.  
©Energizer Holdings, Inc. - Contents herein do not constitute a warranty.