

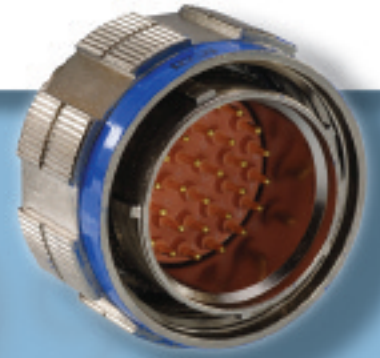

ITT

Electronic Components

Cannon MIL-DTL-38999 Connectors



Engineered for life

Delivering solutions that perform ...

ITT offers an extensive array of connector and switch products and the ability to deliver standard or custom solutions to meet the most stringent military requirements.

Our interconnect range includes sealed circulars, plastic and metal shell bayonet coupling circulars, miniature metal shell circulars, PC board header connectors and sensor and direct device connectors. ITT is also a systems supplier, providing value-added module and harness assemblies.

In addition to our MIL-DTL-38999 series, we also offer these connectivity solutions:



Cannon KPT / KPSE

Environmentally sealed miniature circular connectors available in two versions: KPT (solder contact) and KPSE (high performance crimp contact). Intermateable and intermountable with all MIL-C-26482 connectors and is available with many materials, finishes and configurations.



Cannon Combo D-Sub

Product offering includes ability to integrate signal and coax, high power, and high voltage.

Table of Contents

| | |
|------------------------------------|-------|
| Specifications and Test Data | 3-5 |
| KJL | 6-9 |
| KJ | 10-15 |
| KJA | 16-18 |
| Polarizing Positions | 19 |
| Contact Arrangements | 20-21 |
| Contacts | 22-24 |
| Torque Values | 25 |
| Backshells | 26-27 |
| Tools | 28 |
| Assembly Instructions | 29 |
| MIL-DTL-38999 Specifications | 30 |



Cannon CA-Bayonet

Signal and power connectors with exceptional sealing against the ingress of fluids and will withstand the effects of high vibrations.



Cannon Microminiature

High performance and reliability with exceptional versatility. Available in rectangular, circular and strip configurations, many of our connectors meet or exceed the applicable requirements of the MIL-DTL-83513 specification.

ITT logo blocks and the composite ITT logo are registered trademarks of ITT Industries. ©2005



SERIES I

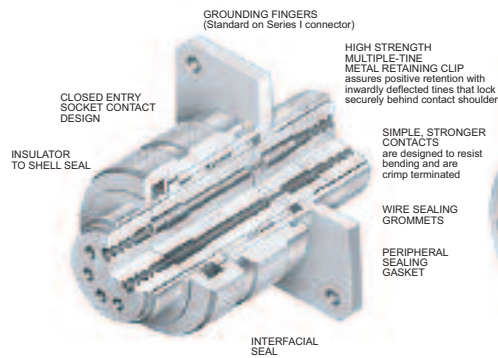

SERIES II

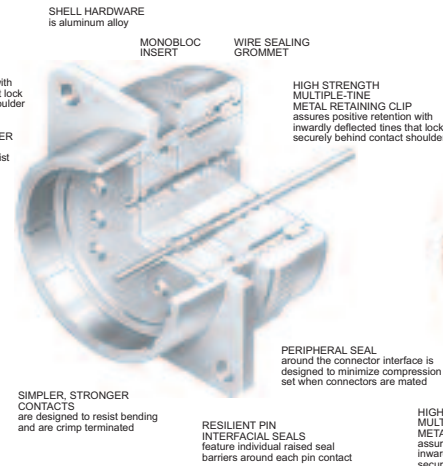

SERIES III

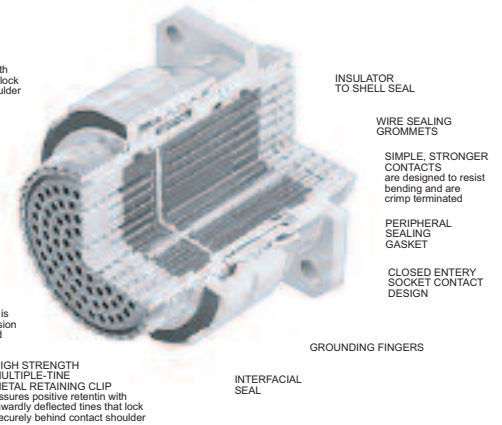

- Corrosion-resistant shells of aluminum alloy with cadmium over nickel plating withstand a 500 hour salt spray exposure
- Rear release crimp snap-in contacts
- High contact density
- Standard MIL-C-39029 contacts, MIL-I-81969 application tools and MIL-STD 1560 insert arrangements
- Special/custom capabilities
- 100% scoop-proof - Series I and III
- Light weight /Low Profile - Series II
- Operates under severe high temperature vibration testing through 200 C - engineered for high density circuitry - Series III
- Interfacial seal helps prevent electrolytic erosion of contacts - Series III
- Superior EMI shielding provides outstanding protection up to 65dB at 10 GHZ. - Series III

Specification Comparison

| Design Criteria | Series I | Series II | Series III |
|--------------------------|--------------|------------|--------------------|
| Low Profile/Light Weight | no | yes | no |
| Scoop Proof | yes | no | yes |
| Coupling System | Bayonet | Bayonet | Triple Lead Thread |
| Electrolytic Erosion | no | no | yes |
| Durability (Cycles) | 500 | 250 | 500 |
| High Impact Shock | yes | no | yes |
| External Bending Moment | | | |
| Shell Size 25 | 650 in/lbs | 150 in/lbs | 1000 in/lbs |
| Random Vibration "J" | Ambient | Ambient | 492 F |
| Sine Vibration | 30G, Ambient | | 60G, -85 to +392 F |
| Sand, Dust, Ice | yes | | yes |
| Shell Size | 9-25 | 8-24 | 9-25 |

Contact Rating

| Contact Size | Test Current DC Test Amperage | Maximum Millivolt Drop* | Crimp Well Data | |
|--------------|-------------------------------|-------------------------|-----------------|------------|
| | | | Well Diameter | Well Depth |
| 22D | 5 | 40 | .0345 ± .0010 | .157/.141 |
| 22M** | 3 | 30 | .0280 ± .0010 | .157/.141 |
| 22** | 5 | 40 | .0365 ± .0010 | .157/.141 |
| 20 | 7.5 | 35 | .0470 ± .0010 | .229/.209 |
| 16 | 13 | 25 | .0670 ± .0010 | .229/.209 |
| 12 | 23 | 25 | .1000 ± .0020 | .229/.209 |

* Maximum millivolt drop data is determined by measuring resistance of mated contacts from end to end

** For reference only

Performance and Material Specifications

MATERIALS AND FINISHES

| | Receptacle | Grounded Plug |
|------------------|--------------------------|--------------------------|
| Shell | Aluminum alloy | Aluminum alloy* |
| Insulator | High grade plastic | High grade plastic |
| Contacts | Copper alloy, gold plate | Copper alloy, gold plate |
| Grommet and Seal | Silicone base elastomer | Silicone base elastomer |
| Jam Nut | Aluminum alloy | - |
| Grounding Spring | - | Beryllium copper |

*Finish as noted in How To Order sections.

ELECTRICAL DATA

Contact Size: 22D, 22M*, 22*, 20, 16 and 12

Contact Rating and Wire Size Accomodation

| Wire Size | Contact Size and Test Amps | | | | | |
|-----------|----------------------------|------|-----|-----|------|------|
| | 22D | 22M* | 22* | 20 | 16 | 12 |
| 28 | 1.5 | 1.5 | - | - | - | - |
| 26 | 2.0 | 2.0 | 2.0 | - | - | - |
| 24 | 3.0 | 3.0 | 3.0 | 3.0 | - | - |
| 22 | 5.0 | - | 5.0 | 5.0 | - | - |
| 20 | - | - | - | 7.5 | 7.5 | - |
| 18 | - | - | - | - | 10.0 | - |
| 16 | - | - | - | - | 13.0 | - |
| 14 | - | - | - | - | - | 17.0 |
| 12 | - | - | - | - | - | 23.0 |

*For reference only

Service Rating

| Altitude | Service Rating M | | Service Rating N | | Service Rating I | | Service Rating II | |
|-------------|------------------|---------|------------------|---------|------------------|---------|-------------------|---------|
| | Mated | Unmated | Mated | Unmated | Mated | Unmated | Mated | Unmated |
| Sea Level | 1300 | 1300 | 1000 | 1000 | 1800 | 1800 | 2300 | 2300 |
| 50,000 ft. | 800 | 550 | 600 | 400 | 1000 | 600 | 1000 | 800 |
| 70,000 ft. | 800 | 350 | 600 | 260 | 1000 | 400 | 1000 | 500 |
| 100,000 ft. | 800 | 200 | 600 | 200 | 1000 | 200 | 1000 | 200 |

Test voltage, AC (rms)

Test Data

| Test Description | Parameters |
|------------------------------------|--|
| Durability | 500 cycles of mating and unmating, 250 cycles for Series II with spring fingers |
| Temperature Range | Class F, N; - 65°C (-85°F) to + 200°C (+392°F) Class A; - 65°C (-85°F) to + 150°C (+302°F) Class B,W: - 65°C (-85°F) to + 175°C (+347°F) |
| Vibration | Mated connectors are vibrated with weights to simulate rear accessory loads to the following levels: Sine Vibration: Up to 60 G's - Series I & III (at rated temperature - Series III) Not applicable for Series II. Random Vibration: 43.7 Grms at rated temperature - Series III 49.5 Grms at Ambient Temperature - Series I & III 43.7 Grms at Ambient Temperature - Series II |
| EMI Shielding Effectiveness | Class F: EMI leakage attenuation, greater than 90dB at 100Mhz, greater than 65dB at 10 GHz. Shell to shell conductivity, 1.0 millivolt max. resistance. Class W: EMI leakage attenuation, greater than 90dB at 100 MHz, greater than 50dB at 10 GHz. Shell to shell conductivity, 2.5 millivolt max. |
| Corrosion Resistant | Class B, W, will withstand 500 hours salt spray. Class A, F, N, will withstand 48 hours salt spray. |
| Fluid Immersion | Connectors are fluid resistant to many fuels, solvents, coolants and oils. |
| High Impact Shock | Mated connectors terminated with MIL-C-915 cable and environmentally sealed backshells will withstand high impact shock per MIL-S-901. Applicable to Series I & III only. |
| Altitude | Designed to operate between sea level and 100,000 ft. above sea level. |
| Other Environments | Mated connectors shall withstand sand and dust per method 110 of MIL-STD-202 and be ice resistant. Applicable to Series I & III only. |

NOTE: For hermetic standard or test data please consult ITT.



Insert Availability and Identification

| Series II | Series I & III | Service Rating | Total Contacts | Contact Size | | | | |
|-----------|----------------|-----------------|----------------|--------------|----|----|----|------|
| | | | | 22D | 20 | 16 | 12 | 8 |
| 8-35 | 9-35 | M | 6 | 6 | | | | |
| 8-98 | 9-98 | I | 3 | | 3 | | | |
| | 11-4 | I | 4 | | 4 | | | |
| 10-5 | 11-5 | I | 5 | | 5 | | | |
| 10-35 | 11-35 | M | 13 | 13 | | | | |
| 10-98 | 11-98 | I | 6 | | 6 | | | |
| 10-99 | 11-99 | I | 7 | | 7 | | | |
| 12-3 | | II | 3 | | | | 3 | |
| 12-4 | 13-4 | I | 4 | | | | 4 | |
| 12-8 | 13-8 | I | 8 | | 8 | | | |
| 12-35 | 13-35 | M | 22 | 22 | | | | |
| 12-98 | 13-98 | I | 10 | | 10 | | | |
| 14-5 | 15-5 | II | 5 | | | | 5 | |
| 14-15 | 15-15 | I | 15 | | 14 | | 1 | |
| 14-18 | 15-18 | I | 18 | | 18 | | | |
| | 15-19 | I | 19 | | 19 | | | |
| 14-35 | 15-35 | M | 37 | 37 | | | | |
| 14-97 | 15-97 | I | 12 | | 8 | | 4 | |
| 16-6 | 17-6 | I | 6 | | | | | 6 |
| 16-8 | 17-8 | II | 8 | | | | 8 | |
| 16-26 | 17-26 | I | 26 | | 26 | | | |
| 16-35 | 17-35 | M | 55 | 55 | | | | |
| 16-99 | 17-99 | I | 23 | | 21 | | 2 | |
| 18-11 | 19-11 | II | 11 | | | | 11 | |
| 18-28 | 19-28 | I | 28 | | 26 | | 2 | |
| 18-30 | 19-30 | I | 30 | | 29 | | 1 | |
| 18-32 | 19-32 | I | 32 | | 32 | | | |
| 18-35 | 19-35 | M | 66 | 66 | | | | |
| | 21-11 | I | 11 | | | | | 11 |
| 20-16 | 21-16 | II | 16 | | | | 16 | |
| 20-35 | 21-35 | M | 79 | 79 | | | | |
| 20-39 | 21-39 | I | 39 | | 37 | | 2 | |
| 20-41 | 21-41 | I | 41 | | 41 | | | |
| | 21-75 | M | 4 | | | | | 4*** |
| 22-21 | 23-21 | II | 21 | | | | 21 | |
| 22-32 | 23-32 | I | 32 | | 32 | | | |
| 22-35 | 23-35 | M | 100 | 100 | | | | |
| 22-53 | 23-53 | I | 53 | | 53 | | | |
| 22-55 | 23-55 | I | 55 | | 55 | | | |
| 24-4 | 25-4 | I | 56 | | 48 | | 8 | |
| | 25-19 | I | 19 | | | | | 19 |
| 24-24 | 25-24 | I | 24 | | | | 12 | 12 |
| 24-29 | 25-29 | I | 29 | | | | 29 | |
| 24-35 | 25-35 | M | 128 | 128 | | | | |
| | 25-37 | I | 37 | | | | 37 | |
| | 25-43 | I | 43 | | 23 | | 20 | |
| | 25-46 | I, Twinax | 46 | | 40 | | 4 | 2*** |
| | 25-8 | Twinax | 8 | | | | | 8*** |
| | 25-20 | N, Coax, Twinax | 30 | | 10 | | 13 | 4** |
| | 25-42 | I, Coax | 42 | | 38 | | | 4* |
| 24-61 | 25-61 | I | 61 | | 61 | | | |
| | 25-64 | I | 64 | 40 | 8 | | 10 | 6 |
| | 25-66 | I | 66 | 53 | 2 | | 11 | |

* Coax for RG-180 cables
 ** Coax for RG-174, -179, or -316 cables
 *** Twinax for M17/176-00002 cables
 (check factory for other cable applications)

How To Order

Military Nomenclature

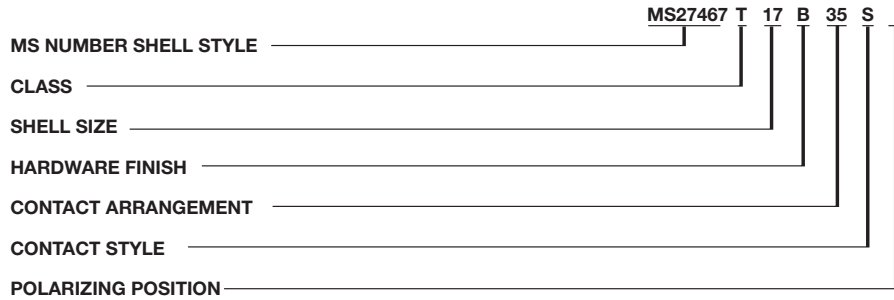

MS NUMBER SHELL STYLE

- MS27466 - Wall Mounting Receptacle
- MS27468 - Jam Nut Receptacle
- MS27467 - Grounded Plug
- MS27656 - Wall Mounting Receptacle (back panel mounting)
- MS27505 - Box Mounting Receptacle (back panel) (Class E)

CLASS

- E - Inactive for new design. Superseded by Class T.
- P - Environment - resistant with straight potting cup accessories
- T - Environment - resistant with accessory threads and teeth, except MS27505 (without rear accessory) (Class T not applicable to MS27505)

SHELL SIZE

9, 11, 13, 15, 17, 19, 21, 23, and 25

HARDWARE FINISH STANDARD

- A - Bright cadmium over electroless nickel plate, -85°F to +302°F (-65°C to +150°C)
- B - Olive drab cadmium over electroless nickel plate, -85°F to +347°F (-65°C to +175°C)
- F - Electroless nickel, -85°F to +392°F (-65°C to +200°C)

CONTACT ARRANGEMENT

See pages 20 and 21.

CONTACT STYLE

- P - Pin
- S - Socket
- *A - Less Pin Contact
- *B - Less Socket Contact

*Used only when other than power contacts are to be installed (i.e. shielded, thermocouple, etc.)

POLARIZING POSITION

A, B, C, and D. (No letters required for normal). See page 19.

Note: To order MS connectors less standard power contacts, purchase order must state "Less Contacts"

Cannon Nomenclature

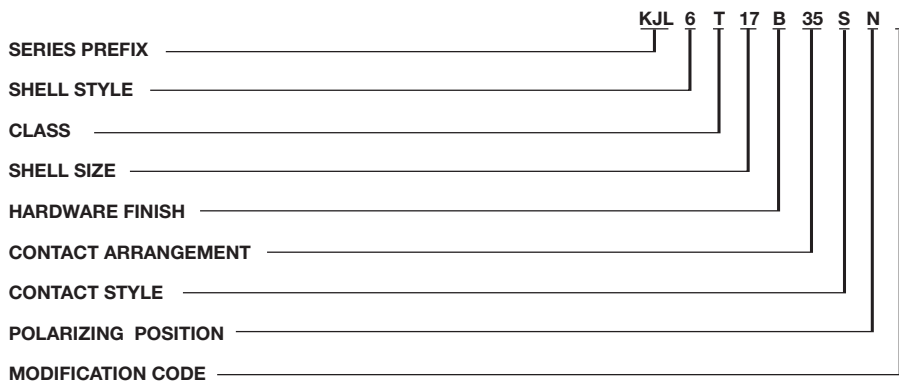

SERIES PREFIX

KJL - Series I-Scoop proof

SHELL STYLE

- 0 - Wall mounting receptacle
- 3 - Wall mounting receptacle (back panel mounting)
- 5 - Box mounting receptacle (back panel mounting)
- 6 - Straight plug, grounded
- 7 - Jam nut receptacle

CLASS

- E - Inactive for new design. Superseded by Class T.
- F - Environment - resistant with strain relief accessory
- P - Environment - resistant with straight potting cup accessory
- T - Environment - resistant (without rear accessory) (Class T not applicable to KJL5)

SHELL SIZE

9, 11, 13, 15, 17, 19, 21, 23 and 25

HARDWARE FINISH STANDARD

- A - Bright cadmium over electroless nickel plate, -85°F to +302°F (-65°C to +150°C)
- B - Olive drab cadmium over electroless nickel plate, -85°F to +347°F (-65°C to +175°C)
- N - Electroless nickel, -85°F to +392°F (-65°C to +200°C)

CONTACT ARRANGEMENT

See pages 20 and 21.

CONTACT STYLE

- P - Pin
- S - Socket

POLARIZING POSITION

N (normal), A, B, C, D. See page 19.

MODIFICATION CODE

- L - Less contacts, not stamped on connector
- 16 - Outgassed NASA space graded connector
- 27 - Outgassed, standard connector



Wall Mounting Receptacle

MS27466
(MS service class E, P, T)

KJL0

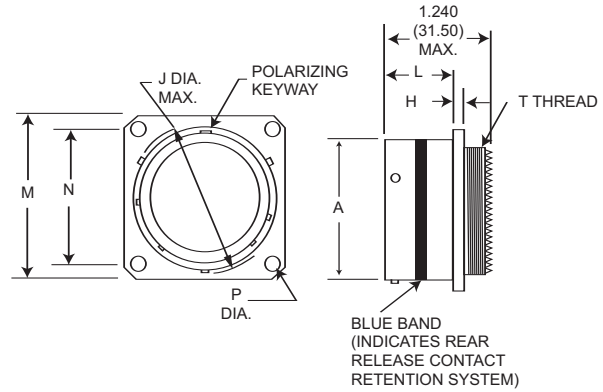

NOTE: For backshell dimensions and configurations, see pages 26 and 27.

| Shell Size | A Dia. Max. | H Max. | J Dia. Max. | L Max. | M Max. | N T.P. | P Dia. Max. | T Thread | Overall Length With Backshells | |
|------------|---------------|-------------|---------------|--------------|---------------|---------------|-------------|------------------|--------------------------------|----------------|
| | | | | | | | | | F Cable Clamp | P Potting Max. |
| 9 | .573 (14.55) | .100 (2.54) | .662 (16.81) | .632 (16.05) | .958 (24.33) | .719 (18.26) | .138 (3.51) | 7/16-28UNEF-2A | 1.846 (46.89) | 1.451 (36.86) |
| 11 | .701 (17.81) | .100 (2.54) | .810 (20.57) | .632 (16.05) | 1.051 (26.70) | .812 (20.62) | .138 (3.51) | 9/16-24UNEF-2A | 1.846 (46.89) | 1.451 (36.86) |
| 13 | .851 (21.62) | .100 (2.54) | .960 (24.38) | .632 (16.05) | 1.145 (29.08) | .906 (23.01) | .138 (3.51) | 11/16-24UNEF-2A | 1.846 (46.89) | 1.451 (36.86) |
| 15 | .976 (24.79) | .100 (2.54) | 1.085 (27.56) | .632 (16.05) | 1.239 (31.47) | .969 (24.61) | .138 (3.51) | 13/16-20UNEF-2A | 1.846 (46.89) | 1.451 (36.86) |
| 17 | 1.101 (27.97) | .100 (2.54) | 1.210 (30.73) | .632 (16.05) | 1.332 (33.83) | 1.062 (26.97) | .138 (3.51) | 15/16-20UNEF-2A | 1.966 (49.94) | 1.451 (36.86) |
| 19 | 1.208 (30.68) | .100 (2.54) | 1.317 (33.45) | .632 (16.05) | 1.458 (37.03) | 1.156 (29.36) | .138 (3.51) | 1-1/16-18UNEF-2A | 1.966 (50.70) | 1.451 (36.86) |
| 21 | 1.333 (33.86) | .130 (3.30) | 1.442 (36.63) | .602 (15.29) | 1.582 (40.18) | 1.250 (31.75) | .138 (3.51) | 1-3/16-18UNEF-2A | 1.966 (50.70) | 1.451 (36.86) |
| 23 | 1.458 (37.03) | .130 (3.30) | 1.567 (39.80) | .602 (15.29) | 1.708 (43.38) | 1.375 (34.93) | .157 (3.99) | 1-5/16-18UNEF-2A | 1.966 (50.70) | 1.451 (36.86) |
| 25 | 1.583 (40.21) | .130 (3.30) | 1.692 (42.98) | .602 (15.29) | 1.832 (46.53) | 1.500 (38.10) | .157 (3.99) | 1-7/16-18UNEF-2A | 1.966 (50.70) | 1.451 (36.86) |

Wall Mounting Receptacle (Back Panel)

MS27656
(MS service class E, P, T)

KJL3

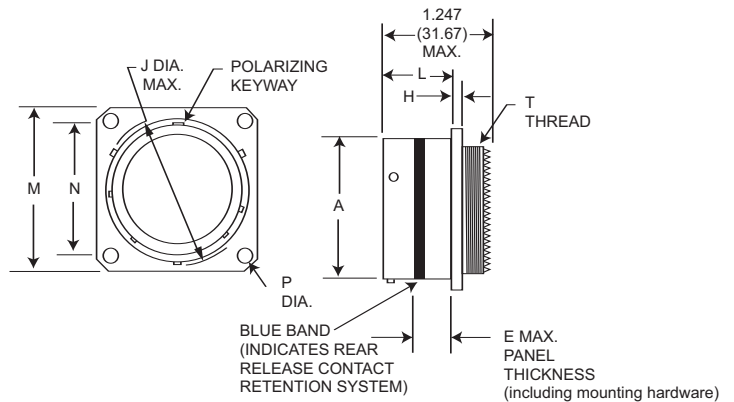

NOTE: For backshell dimensions and configurations, see pages 26 and 27.

| Shell Size | A Dia. Max. | E Max. | H Max. | J Dia. Max. | L Max. | M Max. | N T.P. | P Dia. Max. | T Thread | Overall Length With Backshells | |
|------------|---------------|-------------|-------------|---------------|--------------|---------------|---------------|-------------|------------------|--------------------------------|----------------|
| | | | | | | | | | | F Cable Clamp | P Potting Max. |
| 9 | .573 (14.55) | .234 (5.94) | .100 (2.54) | .662 (16.81) | .820 (20.83) | .958 (24.33) | .719 (18.26) | .138 (3.51) | 7/16-28UNEF-2A | 1.805 (45.85) | 1.410 (35.81) |
| 11 | .701 (17.81) | .234 (5.94) | .100 (2.54) | .810 (20.57) | .820 (20.83) | 1.051 (26.70) | .812 (20.62) | .138 (3.51) | 9/16-24UNEF-2A | 1.805 (45.85) | 1.410 (35.81) |
| 13 | .851 (21.62) | .234 (5.94) | .100 (2.54) | .960 (24.38) | .820 (20.83) | 1.145 (29.08) | .906 (23.01) | .138 (3.51) | 11/16-24UNEF-2A | 1.805 (45.85) | 1.410 (35.81) |
| 15 | .976 (24.79) | .234 (5.94) | .100 (2.54) | 1.085 (27.56) | .820 (20.83) | 1.239 (31.47) | .969 (24.61) | .138 (3.51) | 13/16-20UNEF-2A | 1.805 (45.85) | 1.410 (35.81) |
| 17 | 1.101 (27.97) | .234 (5.94) | .100 (2.54) | 1.210 (30.73) | .820 (20.83) | 1.332 (33.83) | 1.062 (26.97) | .138 (3.51) | 15/16-20UNEF-2A | 1.935 (48.90) | 1.410 (35.81) |
| 19 | 1.208 (30.68) | .234 (5.94) | .100 (2.54) | 1.317 (33.45) | .820 (20.83) | 1.458 (37.03) | 1.156 (29.36) | .138 (3.51) | 1-1/16-18UNEF-2A | 1.955 (49.66) | 1.410 (35.81) |
| 21 | 1.333 (33.86) | .204 (5.18) | .130 (3.30) | 1.442 (36.63) | .790 (20.07) | 1.582 (40.18) | 1.250 (31.75) | .138 (3.51) | 1-3/16-18UNEF-2A | 1.955 (49.66) | 1.410 (35.81) |
| 23 | 1.458 (37.03) | .204 (5.18) | .130 (3.30) | 1.567 (39.80) | .790 (20.07) | 1.708 (43.38) | 1.375 (34.93) | .157 (3.99) | 1-5/16-18UNEF-2A | 1.955 (49.66) | 1.410 (35.81) |
| 25 | 1.583 (40.21) | .193 (4.90) | .130 (3.30) | 1.692 (42.98) | .790 (20.07) | 1.832 (46.53) | 1.500 (38.10) | .157 (3.99) | 1-7/16-18UNEF-2A | 1.955 (49.66) | 1.410 (35.81) |

Performance Specifications-Pages 3-4 Contacts, Sealing Plugs, Assembly Tools - Pages 22, 27, 28. Contact Arrangements - Pages 20-21

Dimensions shown in mm
Specifications and dimensions subject to change

www.ittcannon.com



Box Mounting Receptacle (Back Panel)

MS27505E
(MS service class E)

KJL5E

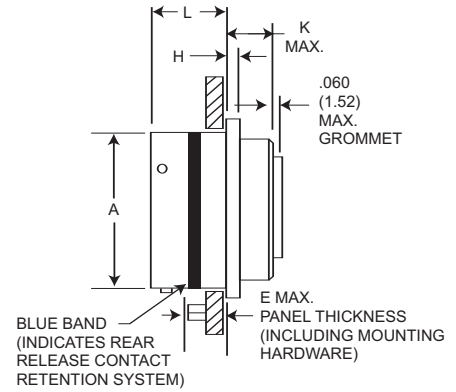
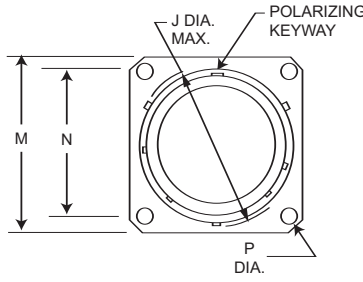

NOTE: This connector does not accommodate backshells.

| Shell Size | A Dia. Max. | E Max. | H Max. | J Dia. Max. | K Max. | L Max. | M Max. | N T.P. | P Dia. Max. |
|------------|---------------|-------------|-------------|---------------|-------------|--------------|---------------|---------------|-------------|
| 9 | .573 (14.55) | .234 (5.94) | .100 (2.54) | .662 (16.81) | .219 (5.56) | .820 (20.83) | .958 (24.33) | .719 (18.26) | .138 (3.51) |
| 11 | .701 (17.81) | .234 (5.94) | .100 (2.54) | .810 (20.57) | .219 (5.56) | .820 (20.83) | 1.051 (26.70) | .812 (20.62) | .138 (3.51) |
| 13 | .851 (21.62) | .234 (5.94) | .100 (2.54) | .960 (24.38) | .219 (5.56) | .820 (20.83) | 1.145 (29.08) | .906 (23.01) | .138 (3.51) |
| 15 | .976 (24.79) | .234 (5.94) | .100 (2.54) | 1.085 (27.56) | .219 (5.56) | .820 (20.83) | 1.239 (31.47) | .969 (24.61) | .138 (3.51) |
| 17 | 1.101 (27.97) | .234 (5.94) | .100 (2.54) | 1.210 (30.73) | .219 (5.56) | .820 (20.83) | 1.332 (33.83) | 1.062 (26.97) | .138 (3.51) |
| 19 | 1.208 (30.68) | .234 (5.94) | .100 (2.54) | 1.317 (33.45) | .219 (5.56) | .820 (20.83) | 1.458 (37.03) | 1.156 (29.36) | .138 (3.51) |
| 21 | 1.333 (33.86) | .204 (5.18) | .130 (3.30) | 1.442 (36.63) | .250 (6.35) | .790 (20.07) | 1.582 (40.18) | 1.250 (31.75) | .138 (3.51) |
| 23 | 1.458 (37.03) | .204 (5.18) | .130 (3.30) | 1.567 (39.80) | .250 (6.35) | .790 (20.07) | 1.708 (43.38) | 1.375 (34.93) | .157 (3.99) |
| 25 | 1.583 (40.21) | .193 (4.90) | .130 (3.30) | 1.692 (42.98) | .250 (6.35) | .790 (20.07) | 1.832 (46.53) | 1.500 (38.10) | .157 (3.99) |

Straight Plug Grounded

MS27467
(MS service class E, P, T)

KJL6

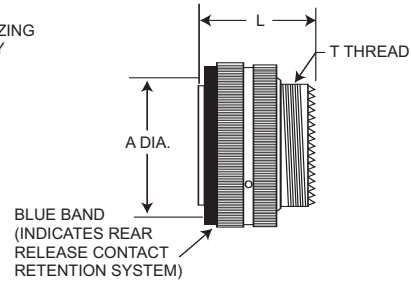
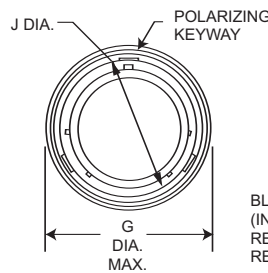
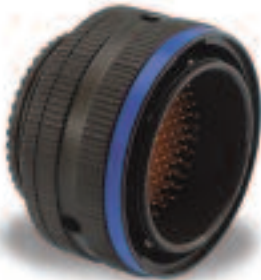

NOTE: For backshell dimensions and configurations, see pages 26 and 27.

| Shell Size | A Max. | G Dia. Max. | J Dia. Max. | (Class T) L Max. | T Thread | Overall Length With Backshells | |
|------------|---------------|---------------|---------------|---------------------|------------------|--------------------------------|----------------|
| | | | | | | F Cable Clamp | P Potting Max. |
| 9 | .585 (14.86) | .859 (21.82) | .483 (12.27) | 1.234 (31.34) | 7/16-28UNEF-2A | 1.793 (45.54) | 1.671 (42.44) |
| 11 | .717 (18.21) | .984 (24.99) | .611 (15.52) | 1.234 (31.34) | 9/16-24UNEF-2A | 1.793 (45.54) | 1.671 (42.44) |
| 13 | .866 (22.00) | 1.156 (29.36) | .760 (19.30) | 1.234 (31.34) | 11/16-24UNEF-2A | 1.793 (45.54) | 1.671 (42.44) |
| 15 | .990 (25.15) | 1.281 (32.54) | .885 (22.48) | 1.234 (31.34) | 13/16-20UNEF-2A | 1.793 (45.54) | 1.671 (42.44) |
| 17 | 1.115 (28.32) | 1.406 (35.71) | 1.010 (25.65) | 1.234 (31.34) | 15/16-20UNEF-2A | 1.913 (48.59) | 1.671 (42.44) |
| 19 | 1.222 (31.04) | 1.516 (38.51) | 1.115 (28.32) | 1.234 (31.34) | 1-1/16-18UNEF-2A | 1.943 (49.35) | 1.671 (42.44) |
| 21 | 1.347 (34.21) | 1.641 (41.68) | 1.240 (31.50) | 1.234 (31.34) | 1-3/16-18UNEF-2A | 1.943 (49.35) | 1.766 (44.86) |
| 23 | 1.472 (37.39) | 1.766 (44.86) | 1.365 (34.67) | 1.234 (31.34) | 1-5/16-18UNEF-2A | 1.943 (49.35) | 1.766 (44.86) |
| 25 | 1.597 (40.56) | 1.891 (48.03) | 1.490 (37.85) | 1.234 (31.34) | 1-7/16-18UNEF-2A | 1.943 (49.35) | 1.766 (44.86) |

Performance Specifications-Pages 3-4

Contacts, Sealing Plugs, Assembly Tools - Pages 22, 27-28.

Contact Arrangements - Pages 20-21



Dimensions shown in mm
Specifications and dimensions subject to change

www.ittcannon.com

Jam Nut Receptacle

MS27468
(MS service class E,P,T)

KJL7

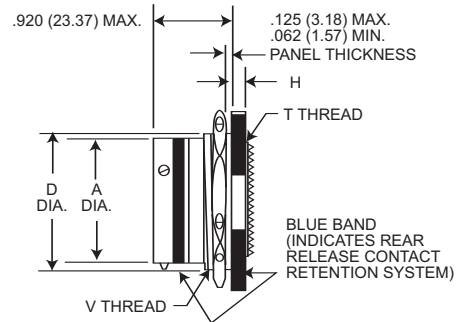
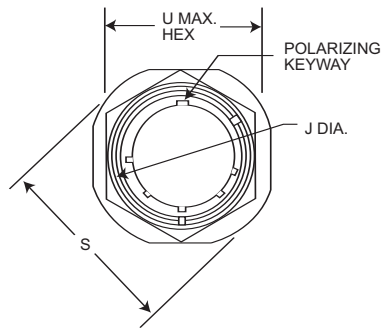

NOTE: For backshell dimensions and configurations, see pages 26 and 27.

| Shell Size | A Dia. Max. | D Max. | H Max. | J Dia. Max. | S Dia. Max. | T Thread | U Max. Hex. | V Thread Class 2A | Overall Length With Backshells | |
|------------|---------------|---------------|-------------|---------------|---------------|------------------|---------------|-------------------|--------------------------------|----------------|
| | | | | | | | | | F Cable Clamp | P Potting Max. |
| 9 | .573 (14.55) | .655 (16.64) | .120 (3.05) | .662 (16.81) | 1.204 (30.58) | 7/16-28UNEF-2A | .892 (22.66) | 11/16-24UNEF | 1.846 (46.89) | 1.451 (36.86) |
| 11 | .701 (17.81) | .755 (19.18) | .120 (3.05) | .810 (20.57) | 1.391 (35.33) | 9/16-24UNEF-2A | 1.017 (25.83) | 13/16-24UNEF | 1.846 (46.89) | 1.451 (36.86) |
| 13 | .851 (21.62) | .942 (23.93) | .120 (3.05) | .960 (24.38) | 1.516 (35.51) | 11/16-24UNEF-2A | 1.205 (30.61) | 1-20UNEF | 1.846 (46.89) | 1.451 (36.86) |
| 15 | .976 (24.79) | 1.066 (27.08) | .120 (3.05) | 1.085 (27.56) | 1.641 (41.68) | 13/16-20UNEF-2A | 1.329 (33.76) | 1-1/8-18UNEF | 1.846 (46.89) | 1.451 (36.86) |
| 17 | 1.101 (27.97) | 1.191 (30.25) | .120 (3.05) | 1.210 (30.73) | 1.766 (44.86) | 15/16-20UNEF-2A | 1.455 (36.96) | 1-1/4-18UNEF | 1.966 (49.94) | 1.451 (36.86) |
| 19 | 1.208 (30.68) | 1.316 (33.43) | .151 (3.84) | 1.317 (33.45) | 1.954 (49.63) | 1-1/16-18UNEF-2A | 1.579 (40.11) | 1-3/8-18UNEF | 1.996 (50.70) | 1.451 (36.86) |
| 21 | 1.333 (33.86) | 1.441 (36.60) | .151 (3.84) | 1.442 (36.63) | 2.078 (52.78) | 1-3/16-18UNEF-2A | 1.705 (43.31) | 1-1/2-18UNEF | 1.996 (50.70) | 1.451 (36.86) |
| 23 | 1.458 (37.03) | 1.566 (39.78) | .151 (3.84) | 1.567 (39.80) | 2.204 (55.98) | 1-5/16-18UNEF-2A | 1.829 (46.46) | 1-5/8-18UNEF | 1.996 (50.70) | 1.451 (36.86) |
| 25 | 1.583 (40.21) | 1.691 (42.95) | .151 (3.84) | 1.692 (42.98) | 2.328 (59.13) | 1-7/16-18UNEF-2A | 20.17 (51.23) | 1-3/4-18UNS | 1.996 (50.70) | 1.451 (36.86) |

Performance Specifications-Pages 3-4

Contacts, Sealing Plugs, Assembly Tools - Pages 22, 27-28.

Contact Arrangements - Pages 20-21

Panel Cutouts

Flange Mounted Receptacles

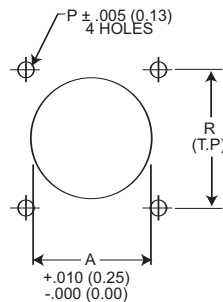

Jam Nut Receptacles

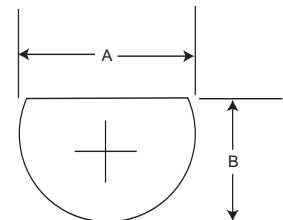

| Shell Size | A Dia. | P Dia. | (Class T) | | Mtg. Screw | Shell Size | A +.010 (.25) -.000 (.00) | B +.000 (.00) -.010 (.25) |
|------------|---------------|-------------|---------------|--|------------|------------|---------------------------------|---------------------------------|
| | | | R | | | | | |
| 9 | .665 (16.89) | .128 (3.25) | .719 (18.26) | | #4 | 9 | .700 (17.78) | .670 (17.02) |
| 11 | .812 (20.62) | .128 (3.25) | .812 (20.62) | | #4 | 11 | .825 (20.96) | .771 (19.58) |
| 13 | .965 (24.51) | .128 (3.25) | .906 (23.01) | | #4 | 13 | 1.010 (25.65) | .955 (24.26) |
| 15 | 1.085 (27.55) | .128 (3.25) | .969 (24.61) | | #4 | 15 | 1.135 (28.83) | 1.085 (27.56) |
| 17 | 1.250 (31.75) | .128 (3.25) | 1.062 (26.97) | | #4 | 17 | 1.260 (32.00) | 1.210 (30.73) |
| 19 | 1.322 (33.57) | .128 (3.25) | 1.156 (29.36) | | #4 | 19 | 1.385 (35.18) | 1.335 (33.91) |
| 21 | 1.447 (36.75) | .128 (3.25) | 1.250 (31.75) | | #4 | 21 | 1.510 (38.35) | 1.460 (37.08) |
| 23 | 1.569 (39.85) | .154 (3.91) | 1.375 (34.93) | | #6 | 23 | 1.635 (41.53) | 1.585 (40.26) |
| 25 | 1.703 (43.25) | .150 (3.81) | 1.500 (38.10) | | #6 | 25 | 1.760 (44.70) | 1.710 (43.43) |

Dimensions shown in mm

Specifications and dimensions subject to change

www.ittcannon.com



How To Order

Military Nomenclature

MS NUMBER SHELL STYLE

- MS27472 - Wall Mounting Receptacle
- MS27473 - Straight Plug
- MS27474 - Jam Nut Receptacle
- MS27484 - Grounded Plug
- MS27497 - Wall Mounting Receptacle (back panel mounting)
- MS27513 - Box Mounting Receptacle
- MS27499 - Box Mounting Receptacle (Class E)
- MS27508 - Box Mounting (back panel mounting) (Class E)

CLASS

- E - Environment - resistant with rear accessory (without strain relief)
- P - Environment - resistant with straight potting cup accessories
- T - Environment - resistant (without rear accessory). (Class T not applicable to MS27499, MS27513, and MS27508.)



SHELL SIZE

8, 10, 12, 14, 16, 18, 20, 22, 24.

HARDWARE FINISH STANDARD

- A - Bright cadmium over electroless nickel plate, - 85°F to + 302°F (- 65°C to + 150°C)
- B - Olive drab cadmium over electroless nickel plate, - 85°F to + 347°F (- 65°C to + 175°C)
- F - Electroless nickel, - 85°F to + 392°F (-65°C to + 200°C)

CONTACT ARRANGEMENT

See pages 20 and 21.

CONTACT STYLE

- P - Pin
- S - Socket
- *A - Less Pin Contact
- *B - Less Socket Contact

*Used only when other than power contacts are to be installed (i.e. shielded, thermocouple, etc.)

POLARIZING POSITION

A, B, C, and D (no letter required for normal). See page 19.

Note: To order MS connectors less standard power contacts, purchase order must state "Less Contacts".

ITT Nomenclature

SERIES PREFIX

- KJ - Series II - Low Profile

SHELL STYLE

- 0 - Wall mounting receptacle
- 2 - Box mounting receptacle
- 3 - Wall mounting receptacle (back panel mounting)
- 5 - Box mounting receptacle (back panel mounting)
- 6 - Straight plug
- G6 - Straight plug, grounded
- 7 - Jam nut receptacle

CLASS

- E - Environment - resistant with rear accessory (without strain relief)
- F - Environment - resistant with strain relief accessory
- P - Environment - resistant with straight potting cup accessory
- R - Environment - resistant with full grommet seal without rear accessory; shell styles 2 and 5 only
- T - Environment - resistant (without rear accessory). (Class T not applicable to KJ2E, KJ2R, KJ5E and KJ5R.)



Note KJ supplied with exact complement of contacts.

SHELL SIZE

8, 10, 12, 14, 16, 18, 20, 22, and 24.

HARDWARE FINISH STANDARD

- A - Bright cadmium over electroless nickel plate, - 85°F to + 302°F (- 65°C to + 150°C)
- B - Olive drab cadmium over electroless nickel plate, - 85°F to + 347°F (- 65°C to + 175°C)
- N - Electroless nickel, - 85°F to + 392°F (-65°C to + 200°C)

CONTACT ARRANGEMENT

See pages 132 and 133.

CONTACT STYLE

- P - Pin
- S - Socket

POLARIZING POSITION

N(normal), A, B, C, D, see page 19.

MODIFICATION CODE

- L - Less contacts, not stamped on connector
- 16 - Outgassed NASA space graded connector
- 27 - Outgassed, standard connector



Wall Mounting Receptacle

MS27472
(MS service class E, P, T)

KJ0

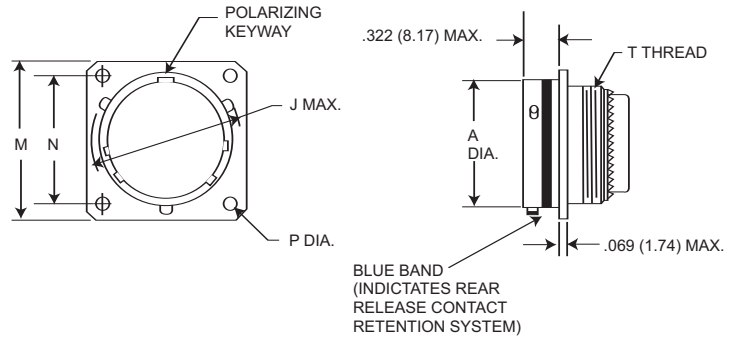

NOTE: For backshell dimensions and configurations, see page 26 and 27.

| Shell Size | A Dia. Max. | J Dia. Max. | M Max. | N T.P. | P +.005 (0.13) -0.010 (0.25) | T Thread | Overall length With Backshells | | |
|------------|---------------|---------------|---------------|---------------|------------------------------|------------------|--------------------------------|---------------|----------------|
| | | | | | | | E Straight | F Cable Clamp | P Potting Max. |
| 8 | .474 (12.04) | .563 (14.30) | .828 (21.03) | .594 (15.09) | .125 (3.18) | 7/16-28UNEF-2A | .850 (21.59) | 1.555 (39.50) | 1.020 (25.91) |
| 10 | .591 (15.01) | .680 (17.27) | .954 (24.23) | .719 (18.26) | .125 (3.18) | 9/16-24UNEF-2A | .850 (21.59) | 1.555 (39.50) | 1.020 (25.91) |
| 12 | .751 (19.08) | .859 (21.82) | 1.047 (26.59) | .812 (20.62) | .125 (3.18) | 11/16-24UNEF-2A | .850 (21.59) | 1.555 (39.50) | 1.020 (25.91) |
| 14 | .876 (22.25) | .984 (24.99) | 1.141 (28.98) | .906 (23.01) | .125 (3.18) | 13/16-20UNEF-2A | .850 (21.59) | 1.790 (45.47) | 1.020 (25.91) |
| 16 | 1.001 (25.43) | 1.108 (28.14) | 1.234 (31.34) | .969 (24.61) | .125 (3.18) | 15/16-20UNEF-2A | .850 (21.59) | 1.790 (45.47) | 1.020 (25.91) |
| 18 | 1.126 (28.60) | 1.233 (31.32) | 1.328 (33.73) | 1.062 (26.97) | .125 (3.18) | 1-1/16-18UNEF-2A | .850 (21.59) | 1.790 (45.47) | 1.020 (25.91) |
| 20 | 1.251 (31.78) | 1.358 (34.49) | 1.453 (36.91) | 1.156 (27.36) | .125 (3.18) | 1-3/16-18UNEF-2A | .850 (21.59) | 1.790 (45.47) | 1.020 (25.91) |
| 22 | 1.376 (34.95) | 1.483 (37.67) | 1.578 (39.08) | 1.250 (31.76) | .125 (3.18) | 1-5/16-18UNEF-2A | .850 (21.59) | 1.930 (49.02) | 1.020 (25.91) |
| 24 | 1.501 (38.13) | 1.610 (40.89) | 1.703 (43.26) | 1.375 (34.92) | .152 (3.86) | 1-7/16-18UNEF-2A | .850 (21.59) | 1.900 (48.26) | 1.080 (27.43) |

Box Mounting Receptacle

MS27499E
(MS service class E)

KJ2E

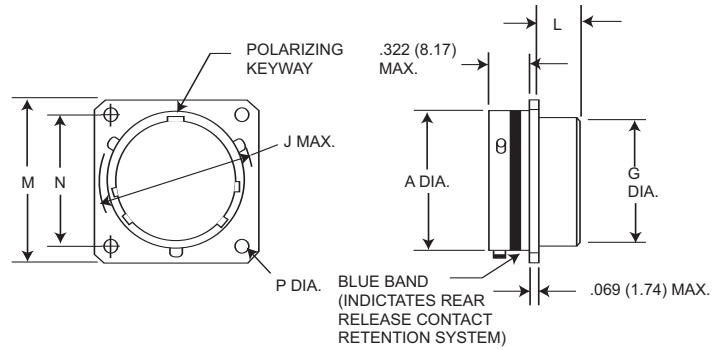

NOTE: This connector does not accommodate backshells

| Shell Size | A Dia. Max. | G Dia. Max. | J Dia. Max. | L Max. | M Max. | N T.P. | P +.005 (0.13) -0.010 (0.25) |
|------------|---------------|---------------|---------------|-------------|---------------|---------------|------------------------------|
| 8 | .474 (12.04) | .421 (10.69) | .563 (14.30) | .312 (7.92) | .828 (21.03) | .594 (15.09) | .125 (3.18) |
| 10 | .591 (15.01) | .542 (13.77) | .680 (17.27) | .312 (7.92) | .954 (24.23) | .719 (18.26) | .125 (3.18) |
| 12 | .751 (19.08) | .667 (16.94) | .859 (21.82) | .312 (7.92) | 1.047 (26.59) | .812 (20.62) | .125 (3.18) |
| 14 | .876 (22.25) | .791 (20.09) | .984 (24.99) | .312 (7.92) | 1.141 (28.98) | .906 (23.01) | .125 (3.18) |
| 16 | 1.001 (25.43) | .916 (23.27) | 1.108 (28.14) | .312 (7.92) | 1.234 (31.34) | .969 (24.61) | .125 (3.18) |
| 18 | 1.126 (28.60) | 1.034 (26.26) | 1.233 (31.32) | .312 (7.92) | 1.328 (33.73) | 1.062 (26.97) | .125 (3.18) |
| 20 | 1.251 (31.78) | 1.158 (29.41) | 1.358 (34.49) | .312 (7.92) | 1.453 (36.81) | 1.156 (27.36) | .125 (3.18) |
| 22 | 1.376 (33.95) | 1.283 (32.59) | 1.483 (37.67) | .312 (7.92) | 1.578 (40.08) | 1.250 (31.75) | .125 (3.18) |
| 24 | 1.501 (38.13) | 1.408 (35.76) | 1.610 (40.89) | .312 (7.92) | 1.703 (43.26) | 1.375 (34.93) | .152 (3.86) |

Performance Specifications-Pages 3-4

Contacts, Sealing Plugs, Assembly Tools - Pages 22, 27-28

Contact Arrangements - Pages 20-21

Dimensions shown in mm

Specifications and dimensions subject to change

www.ittcannon.com



Box Mounting Receptacle

MS27513E
(MS service class E)

KJ2R

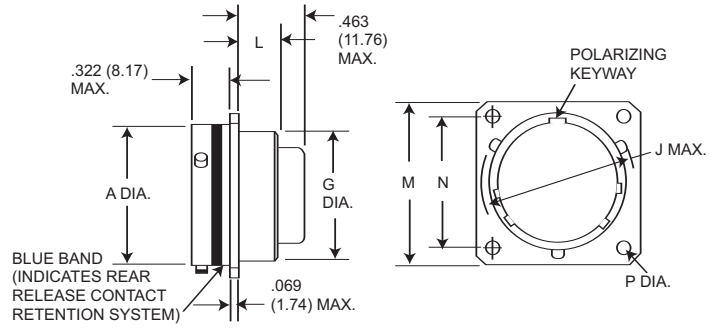
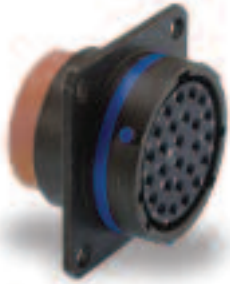

NOTE: This connector does not accommodate backshells

| Shell Size | A Dia. Max. | G Dia. Max. | J Dia. Max. | L Max. | M Max. | N T.P. | P +.005 (0.13) -.010 (0.25) |
|------------|---------------|---------------|---------------|-------------|---------------|---------------|-----------------------------|
| 8 | .474 (12.04) | .421 (10.69) | .563 (14.30) | .312 (7.92) | .828 (21.03) | .594 (15.09) | .125 (3.18) |
| 10 | .591 (15.01) | .542 (13.77) | .680 (17.27) | .312 (7.92) | .954 (24.23) | .719 (18.26) | .125 (3.18) |
| 12 | .751 (19.08) | .667 (16.94) | .859 (21.82) | .312 (7.92) | 1.047 (26.59) | .812 (20.62) | .125 (3.18) |
| 14 | .876 (22.25) | .791 (20.09) | .984 (24.99) | .312 (7.92) | 1.141 (28.98) | .906 (23.01) | .125 (3.18) |
| 16 | 1.001 (25.43) | .916 (23.27) | 1.108 (28.14) | .312 (7.92) | 1.234 (31.34) | .969 (24.61) | .125 (3.18) |
| 18 | 1.126 (28.60) | 1.034 (26.26) | 1.233 (31.32) | .312 (7.92) | 1.328 (33.73) | 1.062 (26.97) | .125 (3.18) |
| 20 | 1.251 (31.78) | 1.158 (29.41) | 1.358 (34.49) | .312 (7.92) | 1.453 (36.81) | 1.156 (27.36) | .125 (3.18) |
| 22 | 1.376 (33.95) | 1.283 (32.59) | 1.483 (27.67) | .312 (7.92) | 1.578 (40.08) | 1.250 (31.75) | .125 (3.18) |
| 24 | 1.501 (38.13) | 1.408 (35.76) | 1.610 (40.89) | .312 (7.92) | 1.703 (43.26) | 1.375 (34.93) | .152 (3.85) |

Wall Mounting Receptacle

MS27497
(MS service class E, P, T)

KJ3

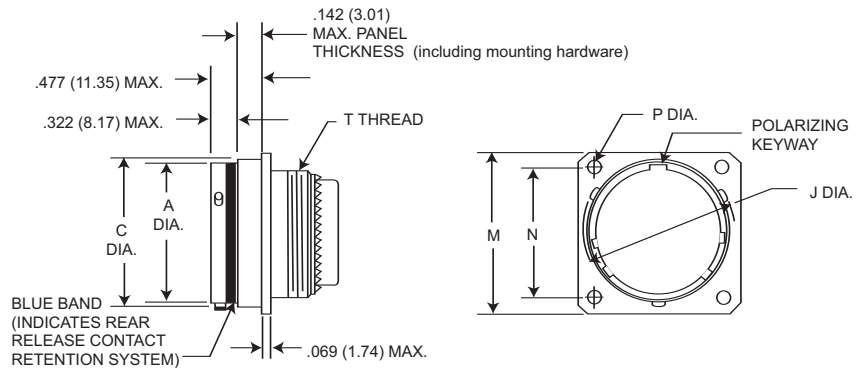

NOTE: For backshell dimensions and configurations, see page 26 and 27

| Shell Size | A Dia. Max. | C Dia. Max. | J Dia. Max. | M Max. | N T.P. | P +.005 (0.13) -.010 (0.25) | T Thread | Overall Length With Backshells | | |
|------------|---------------|---------------|---------------|---------------|---------------|-----------------------------|------------------|--------------------------------|---------------|----------------|
| | | | | | | | | E Straight | F Cable Clamp | P Potting Max. |
| 8 | .474 (12.04) | .522 (13.26) | .563 (14.30) | .828 (21.03) | .594 (15.09) | .125 (3.18) | 7/16-28UNEF-2A | .855 (21.72) | 1.570 (39.88) | 1.020 (25.91) |
| 10 | .591 (15.01) | .639 (16.23) | .680 (17.27) | .954 (24.23) | .719 (18.26) | .125 (3.18) | 9/16-24UNEF-2A | .855 (21.72) | 1.570 (39.88) | 1.020 (25.91) |
| 12 | .751 (19.08) | .808 (20.52) | .859 (21.82) | 1.047 (26.59) | .812 (20.62) | .125 (3.18) | 11/16-24UNEF-2A | .855 (21.72) | 1.570 (39.88) | 1.020 (25.91) |
| 14 | .876 (22.25) | .935 (23.75) | .984 (24.99) | 1.141 (28.98) | .906 (23.01) | .125 (3.18) | 13/16-20UNEF-2A | .855 (21.72) | 1.780 (45.21) | 1.020 (25.91) |
| 16 | 1.001 (25.43) | 1.058 (26.87) | 1.108 (28.14) | 1.234 (31.34) | .969 (24.61) | .125 (3.18) | 15/16-20UNEF-2A | .855 (21.72) | 1.780 (45.21) | 1.020 (25.91) |
| 18 | 1.126 (28.60) | 1.183 (30.05) | 1.233 (31.32) | 1.328 (33.73) | 1.062 (26.97) | .125 (3.18) | 1-1/16-18UNEF-2A | .855 (21.72) | 1.780 (45.21) | 1.020 (25.91) |
| 20 | 1.251 (31.78) | 1.308 (33.22) | 1.358 (34.49) | 1.453 (36.91) | 1.156 (29.36) | .125 (3.18) | 1-3/16-18UNEF-2A | .855 (21.72) | 1.780 (45.21) | 1.020 (25.91) |
| 22 | 1.376 (34.95) | 1.433 (36.40) | 1.483 (37.67) | 1.578 (40.08) | 1.250 (31.75) | .125 (3.18) | 1-5/16-18UNEF-2A | .855 (21.72) | 1.960 (49.78) | 1.020 (25.91) |
| 24 | 1.501 (38.13) | 1.568 (39.83) | 1.610 (40.89) | 1.703 (43.26) | 1.375 (34.93) | .152 (3.86) | 1-7/16-18UNEF-2A | .855 (21.72) | 1.960 (49.78) | 1.080 (27.43) |

Performance Specifications-Pages 3-4

Contacts, Sealing Plugs, Assembly Tools - Pages 22, 27-28

Contact Arrangements - Pages 20-21



Dimensions shown in mm
Specifications and dimensions subject to change

www.ittcannon.com

Box Mounting Receptacle (Back Panel)

MS27508E
(MS service class E)

KJ5E

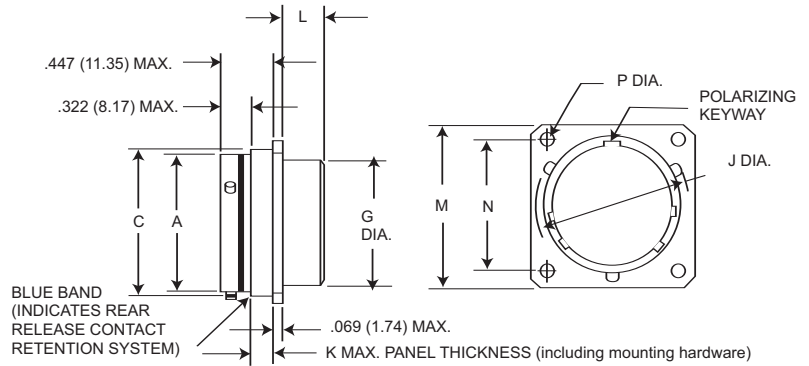

NOTE: This connector does not accommodate backshells

| Shell Size | A Dia. Max. | C Dia. Max. | G Dia. Max. | J Dia. Max. | K Max. | L Max. | M Max. | N T.P. | P +.005 (0.13) -.010 (0.25) |
|------------|---------------|---------------|---------------|---------------|-------------|-------------|---------------|---------------|-----------------------------------|
| 8 | .474 (12.04) | .522 (13.26) | .421 (10.69) | .563 (14.30) | .147 (3.73) | .185 (4.70) | .828 (21.03) | .594 (15.09) | .125 (3.18) |
| 10 | .591 (15.01) | .639 (16.23) | .542 (13.77) | .680 (17.27) | .152 (3.86) | .185 (4.70) | .954 (24.23) | .719 (18.26) | .125 (3.18) |
| 12 | .751 (19.08) | .808 (20.52) | .667 (16.94) | .859 (21.82) | .152 (3.86) | .185 (4.70) | 1.047 (26.59) | .812 (20.62) | .125 (3.18) |
| 14 | .876 (22.25) | .935 (23.75) | .791 (20.09) | .984 (24.99) | .152 (3.86) | .185 (4.70) | 1.141 (28.98) | .906 (23.01) | .125 (3.18) |
| 16 | 1.001 (25.42) | 1.058 (26.87) | .916 (23.27) | 1.108 (28.14) | .152 (3.86) | .185 (4.70) | 1.234 (31.24) | .969 (24.61) | .125 (3.18) |
| 18 | 1.126 (28.60) | 1.183 (30.05) | 1.034 (31.34) | 1.233 (31.32) | .152 (3.86) | .185 (4.70) | 1.328 (33.73) | 1.062 (26.97) | .125 (3.18) |
| 20 | 1.251 (31.77) | 1.308 (33.22) | 1.158 (34.52) | 1.358 (34.49) | .179 (4.55) | .185 (4.70) | 1.453 (36.91) | 1.156 (29.36) | .125 (3.18) |
| 22 | 1.376 (34.95) | 1.433 (36.40) | 1.283 (32.59) | 1.483 (37.67) | .179 (4.55) | .185 (4.70) | 1.578 (40.08) | 1.250 (31.75) | .125 (3.18) |
| 24 | 1.501 (38.13) | 1.568 (39.83) | 1.408 (35.76) | 1.610 (40.89) | .169 (4.29) | .185 (4.70) | 1.703 (43.66) | 1.375 (34.92) | .152 (3.86) |

Box Mounting Receptacle (Back Panel)

No MS part number

KJ5R

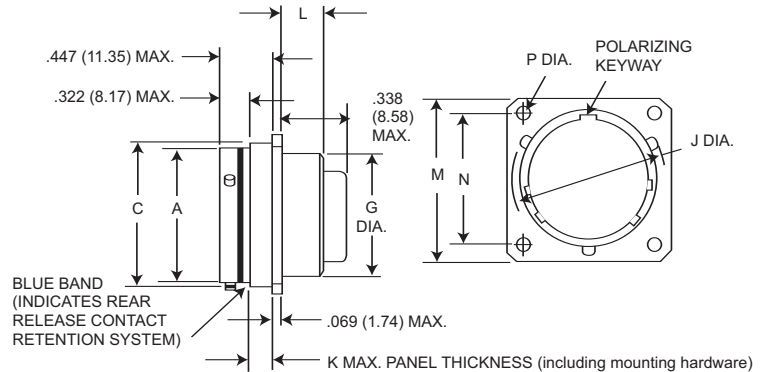

NOTE: This connector does not accommodate backshells

| Shell Size | A Dia. Max. | C Dia. Max. | G Dia. Max. | J Dia. Max. | K Max. | L Max. | M Max. | N T.P. | P +.005 (0.13) -.010 (0.25) |
|------------|---------------|---------------|---------------|---------------|-------------|-------------|---------------|---------------|-----------------------------------|
| 8 | .474 (12.04) | .522 (13.26) | .421 (10.69) | .563 (14.30) | .147 (3.73) | .185 (4.70) | .828 (21.03) | .594 (15.09) | .125 (3.18) |
| 10 | .591 (15.01) | .639 (16.23) | .542 (13.77) | .680 (17.27) | .152 (3.86) | .185 (4.70) | .954 (24.23) | .719 (18.26) | .125 (3.18) |
| 12 | .751 (19.08) | .808 (20.52) | .667 (16.94) | .859 (21.82) | .152 (3.86) | .185 (4.70) | 1.047 (26.59) | .812 (20.62) | .125 (3.18) |
| 14 | .876 (22.25) | .935 (23.75) | .791 (20.09) | .984 (24.99) | .152 (3.86) | .185 (4.70) | 1.141 (28.98) | .906 (23.01) | .125 (3.18) |
| 16 | 1.001 (25.42) | 1.058 (26.87) | .916 (23.27) | 1.108 (28.14) | .152 (3.86) | .185 (4.70) | 1.234 (31.24) | .969 (24.61) | .125 (3.18) |
| 18 | 1.126 (28.60) | 1.183 (30.05) | 1.034 (31.34) | 1.233 (31.32) | .152 (3.86) | .185 (4.70) | 1.328 (33.73) | 1.062 (26.97) | .125 (3.18) |
| 20 | 1.251 (31.77) | 1.308 (33.22) | 1.158 (34.52) | 1.358 (34.49) | .179 (4.55) | .185 (4.70) | 1.453 (36.91) | 1.156 (29.36) | .125 (3.18) |
| 22 | 1.376 (34.95) | 1.433 (36.40) | 1.283 (32.59) | 1.483 (37.67) | .179 (4.55) | .185 (4.70) | 1.578 (40.08) | 1.250 (31.75) | .125 (3.18) |
| 24 | 1.501 (38.13) | 1.568 (39.83) | 1.408 (35.76) | 1.610 (40.89) | .169 (4.29) | .185 (4.70) | 1.703 (43.66) | 1.375 (34.92) | .152 (3.86) |

Performance Specifications-Pages 3-4

Contacts, Sealing Plugs, Assembly Tools - Pages 22, 27-28

Contact Arrangements - Pages 20-21

Dimensions shown in mm

Specifications and dimensions subject to change

www.ittcannon.com



Straight Plug

MS27473
(MS service class E, P, T)

KJ6

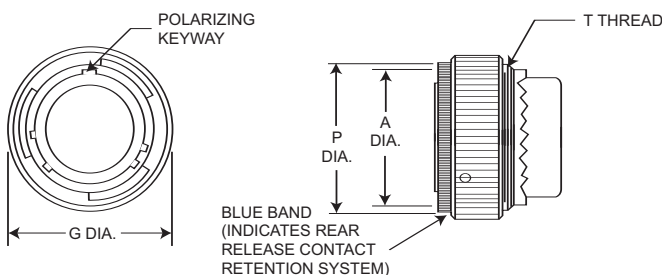
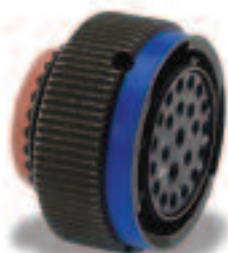

NOTE: For backshell dimensions and configurations, see pages 26 and 27.

| Shell Size | A Dia. Max. | G Dia. Max. | P Dia. Max. | T Thread | Overall Length With Backshells | | |
|------------|---------------|---------------|---------------|------------------|--------------------------------|---------------|----------------|
| | | | | | E Straight | F Cable Clamp | P Potting Max. |
| 8 | .485 (12.32) | .749 (19.02) | .630 (16.00) | 7/16-28UNEF-2A | 1.026 (26.06) | 1.555 (39.50) | 1.020 (25.91) |
| 10 | .606 (15.39) | .858 (21.79) | .752 (19.10) | 9/16-24UNEF-2A | 1.026 (26.06) | 1.555 (39.50) | 1.020 (25.91) |
| 12 | .765 (19.43) | 1.030 (26.16) | .925 (23.50) | 11/16-24UNEF-2A | 1.026 (26.06) | 1.555 (39.50) | 1.020 (25.91) |
| 14 | .890 (22.61) | 1.155 (29.34) | 1.050 (26.67) | 13/16-20UNEF-2A | 1.026 (26.06) | 1.790 (45.47) | 1.020 (25.91) |
| 16 | 1.014 (25.76) | 1.280 (32.51) | 1.172 (29.77) | 15/16-20UNEF-2A | 1.026 (26.06) | 1.790 (45.47) | 1.020 (25.91) |
| 18 | 1.140 (28.96) | 1.405 (35.69) | 1.304 (33.12) | 1-1/16-18UNEF-2A | 1.026 (26.06) | 1.790 (45.47) | 1.020 (25.91) |
| 20 | 1.264 (32.11) | 1.530 (38.86) | 1.435 (36.45) | 1-3/16-18UNEF-2A | 1.026 (26.06) | 1.790 (45.47) | 1.020 (25.91) |
| 22 | 1.389 (35.28) | 1.640 (40.66) | 1.560 (39.62) | 1-5/16-18UNEF-2A | 1.026 (26.06) | 1.930 (49.02) | 1.020 (25.91) |
| 24 | 1.514 (38.46) | 1.765 (44.83) | 1.688 (42.88) | 1-7/16-18UNEF-2A | 1.104 (28.04) | 1.930 (49.02) | 1.080 (27.43) |

Straight Plug Grounded

MS27484
(MS service class E, P, T)

KJG6

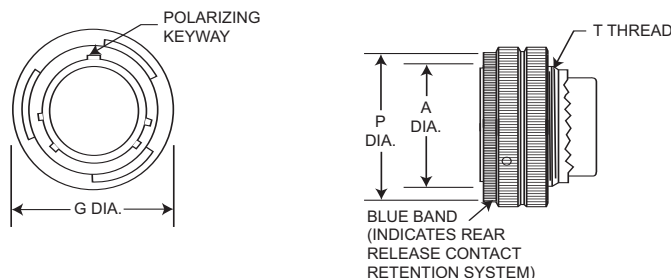

NOTE: For backshell dimensions and configurations, see pages 26 and 27.

| Shell Size | A Dia. Max. | G Dia. Max. | P Dia. Max. | T Thread | Overall Length With Backshells | | |
|------------|---------------|---------------|---------------|------------------|--------------------------------|---------------|----------------|
| | | | | | E Straight | F Cable Clamp | P Potting Max. |
| 8 | .485 (12.32) | .749 (19.02) | .630 (16.00) | 7/16-28UNEF-2A | 1.026 (26.06) | 1.555 (39.50) | 1.020 (25.91) |
| 10 | .606 (15.39) | .858 (21.79) | .752 (19.10) | 9/16-24UNEF-2A | 1.026 (26.06) | 1.555 (39.50) | 1.020 (25.91) |
| 12 | .765 (19.43) | 1.030 (26.16) | .925 (23.50) | 11/16-24UNEF-2A | 1.026 (26.06) | 1.555 (39.50) | 1.020 (25.91) |
| 14 | .890 (22.61) | 1.155 (29.34) | 1.050 (26.67) | 13/16-20UNEF-2A | 1.026 (26.06) | 1.790 (45.47) | 1.020 (25.91) |
| 16 | 1.014 (25.76) | 1.280 (32.51) | 1.172 (29.77) | 15/16-20UNEF-2A | 1.026 (26.06) | 1.790 (45.47) | 1.020 (25.91) |
| 18 | 1.140 (28.96) | 1.405 (35.69) | 1.304 (33.12) | 1-1/16-18UNEF-2A | 1.026 (26.06) | 1.790 (45.47) | 1.020 (25.91) |
| 20 | 1.264 (32.11) | 1.530 (38.86) | 1.435 (36.45) | 1-3/16-18UNEF-2A | 1.026 (26.06) | 1.790 (45.47) | 1.020 (25.91) |
| 22 | 1.389 (35.28) | 1.640 (40.66) | 1.560 (39.62) | 1-5/16-18UNEF-2A | 1.026 (26.06) | 1.930 (49.02) | 1.020 (25.91) |
| 24 | 1.514 (38.46) | 1.765 (44.83) | 1.688 (42.88) | 1-7/16-18UNEF-2A | 1.104 (28.04) | 1.930 (49.02) | 1.080 (27.43) |

Performance Specifications-Pages 3-4

Contacts, Sealing Plugs, Assembly Tools - Pages 22, 27-28

Contact Arrangements - Pages 20-21



Dimensions shown in mm
Specifications and dimensions subject to change

www.ittcannon.com

Jam Nut Receptacle

MS27474
(MS service class E, P, T)

KJ7

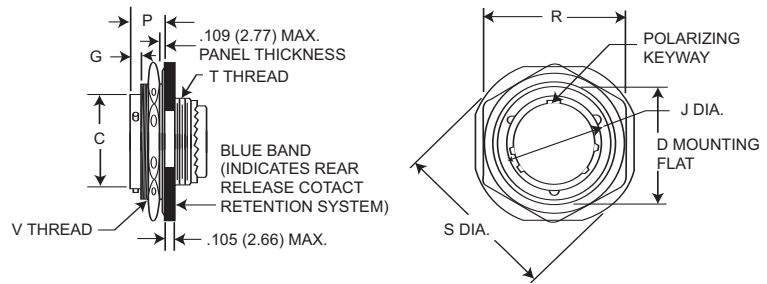

NOTE: For backshell dimensions and configurations, see pages 26 and 27.

| Shell Size | C Dia. Max. | D Max. | G Max. | J Max. | P Max. | R Max. Hex. | S Dia. Max. | T Thread | V Thread | Overall length With Backshells | | |
|------------|---------------|---------------|-------------|---------------|--------------|---------------|---------------|-------------------|-----------------|--------------------------------|---------------|----------------|
| | | | | | | | | | | E Straight | F Cable Clamp | P Potting Max. |
| 8 | .474 (12.04) | .818 (20.78) | .145 (3.68) | .563 (14.30) | .443 (11.25) | 1.079 (27.41) | 1.381 (35.08) | 7/16-28UNEF-2A | 7/8-20UNEF-2A | .840 (21.34) | 1.555 (39.50) | 1.020 (25.91) |
| 10 | .591 (15.01) | .942 (23.93) | .145 (3.68) | .680 (17.27) | .443 (11.25) | 1.205 (30.61) | 1.506 (38.25) | 9/16-24UNEF-2A | 1-20UNEF-2A | .840 (21.34) | 1.555 (39.50) | 1.020 (25.91) |
| 12 | .751 (19.08) | 1.066 (27.08) | .145 (3.68) | .859 (21.82) | .443 (11.25) | 1.329 (33.76) | 1.631 (41.43) | 11/16-24UNEF-2A | 1-1/8-18UNEF-2A | .840 (21.34) | 1.555 (39.50) | 1.020 (25.91) |
| 14 | .876 (22.25) | 1.191 (30.25) | .145 (3.68) | .984 (24.99) | .443 (11.25) | 1.455 (36.96) | 1.756 (44.60) | 13/16-20UNEF-2A | 1-1/4-18UNEF-2A | .840 (21.34) | 1.790 (45.47) | 1.020 (25.91) |
| 16 | 1.001 (25.43) | 1.321 (33.55) | .145 (3.68) | 1.108 (28.14) | .443 (11.25) | 1.579 (40.11) | 1.944 (49.38) | 1-15/16-20UNEF-2A | 1-3/8-18UNEF-2A | .840 (21.34) | 1.790 (45.47) | 1.020 (25.91) |
| 18 | 1.126 (28.60) | 1.441 (36.60) | .145 (3.68) | 1.233 (31.32) | .443 (11.25) | 1.705 (43.31) | 2.022 (51.36) | 1-1/16-18UNEF-2A | 1-1/2-18UNEF-2A | .840 (21.34) | 1.790 (45.47) | 1.020 (25.91) |
| 20 | 1.251 (31.78) | 1.566 (39.78) | .171 (4.34) | 1.358 (34.49) | .469 (11.91) | 1.829 (46.46) | 2.147 (54.53) | 1-3/16-18UNEF-2A | 1-5/8-18UNEF-2A | .840 (21.34) | 1.790 (45.47) | 1.020 (25.91) |
| 22 | 1.376 (33.95) | 1.691 (42.95) | .171 (4.34) | 1.483 (37.67) | .469 (11.91) | 2.017 (51.23) | 2.271 (57.68) | 1-5/16-18UNEF-2A | 1-3/4-18UNEF-2A | .840 (21.34) | 1.930 (49.02) | 1.020 (25.91) |
| 24 | 1.501 (38.13) | 1.816 (46.13) | .171 (4.34) | 1.610 (40.89) | .469 (11.91) | 2.142 (54.41) | 2.396 (60.86) | 1-7/16-18UNEF-2A | 1-7/8-18UNEF-2A | .860 (21.84) | 1.900 (48.26) | 1.080 (27.43) |

Performance Specifications-Pages 3-4

Contacts, Sealing Plugs, Assembly Tools - Pages 22, 27-28

Contact Arrangements - Pages 20-21

Panel Cutouts

Flange Mounted Receptacle

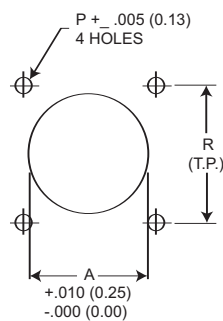

Jam Nut Receptacle

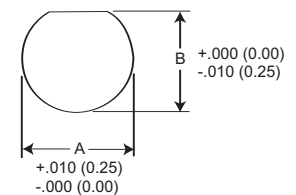

| Shell Size | A Dia. | P Dia. | R | Mfg. Screw |
|------------|---------------|-------------|---------------|------------|
| 8 | .610 (15.49) | .125 (3.18) | .594 (15.09) | #4 |
| 10 | .734 (18.64) | .125 (3.18) | .719 (18.26) | #4 |
| 12 | .860 (21.84) | .125 (3.18) | .812 (20.62) | #4 |
| 14 | .985 (25.02) | .125 (3.18) | .906 (23.01) | #4 |
| 16 | 1.110 (28.19) | .125 (3.18) | .969 (24.61) | #4 |
| 18 | 1.234 (31.34) | .125 (3.18) | 1.062 (26.97) | #4 |
| 20 | 1.360 (35.54) | .125 (3.18) | 1.156 (29.36) | #4 |
| 22 | 1.484 (37.69) | .125 (3.18) | 1.250 (31.75) | #4 |
| 24 | 1.611 (40.92) | .152 (3.86) | 1.375 (34.93) | #6 |

| Shell Size | A Dia. | B Dia. |
|------------|---------------|---------------|
| 8 | .885 (22.48) | .830 (21.08) |
| 10 | 1.010 (25.65) | .955 (24.26) |
| 12 | 1.135 (28.82) | 1.085 (27.56) |
| 14 | 1.260 (32.00) | 1.210 (30.73) |
| 16 | 1.385 (35.18) | 1.335 (33.91) |
| 18 | 1.510 (38.35) | 1.460 (37.08) |
| 20 | 1.635 (41.53) | 1.585 (40.26) |
| 22 | 1.760 (44.70) | 1.710 (43.43) |
| 24 | 1.885 (47.88) | 1.835 (46.61) |

Dimensions shown in mm
 Specifications and dimensions subject to change

www.ittcannon.com



How To Order

Military Nomenclature

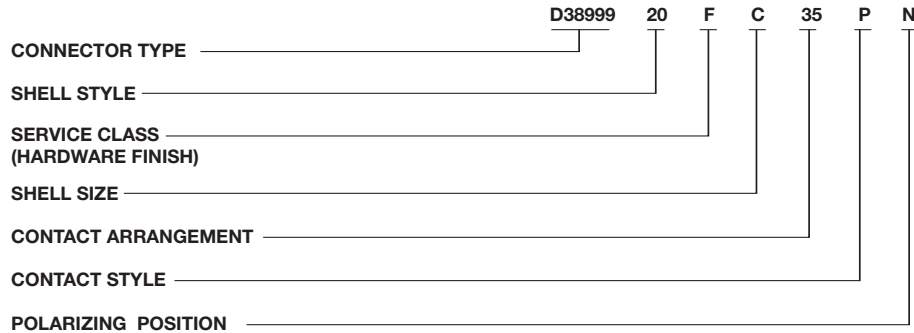

CONNECTOR TYPE
D38999/ - MIL-DTL-38999 Series III

SHELL STYLE
 D38999/20 - Wall mount receptacle
 D38999/24 - Jam nut receptacle
 D38999/26 - Straight Plug, Grounded

SERVICE CLASS
 (Hardware Finish)
 F - Electroless nickel - 85°F to +392°F (-65°C to +200°C)
 W - Olive drab cadmium over electroless nickel plate, -85°F to +347°F (-65°C to +175°C)

SHELL SIZE

| | | | | | | | | | |
|---|----|----|----|----|----|----|----|----|----------------------|
| A | B | C | D | E | F | G | H | J | Military Designation |
| 9 | 11 | 13 | 15 | 17 | 19 | 21 | 23 | 25 | Cannon Designation |

CONTACT ARRANGEMENT
See pages 20 and 21.

CONTACT STYLE
 P - Pin contacts
 S - Socket contact
 A - Less Pin contacts*
 B - Less Socket contact*

* Used only when other than power contacts are to be installed (i.e., shielded, thermocouple, etc.)

POLARIZING POSITION
N (normal), A, B, C, D, E. See page 19.

Note: To order MS connectors less standard power contacts, purchase order must state "Less Contacts".

Cannon Nomenclature

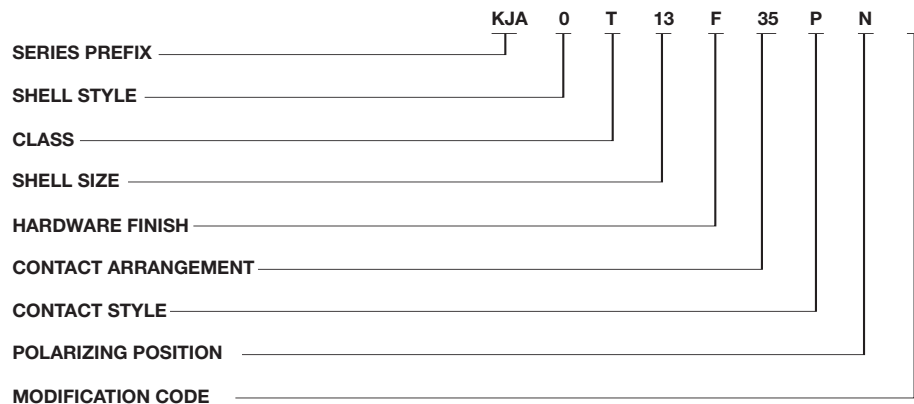

| | | | | | | | | | |
|---|----|----|----|----|----|----|----|----|----------------------|
| 9 | 11 | 13 | 15 | 17 | 19 | 21 | 23 | 25 | Cannon Designation |
| A | B | C | D | E | F | G | H | J | Military Designation |

HARDWARE FINISH
 F -Electroless nickel, - 85°F to +392°F (-65°C to +200°C)
 W -Olive drab cadmium over electroless nickel plate, -85°F to +347°F (-65°C to +175°C)

CONTACT ARRANGEMENTS
See pages 20 and 21.

CONTACT STYLE
 P -Pin contacts
 S -Socket contacts

POLARIZING POSITION
N (normal) A, B, C, D, E. See page 19.

MODIFICATION CODE
 L - Less contacts, not stamped on connector
 16 - Outgassed NASA space graded connector
 27- Outgassed, standard connector

SERIES PREFIX
KJA - Series III - Scoop proof, threaded coupling

SHELL STYLE
 0 - Wall mount receptacle
 6 - Straight plug
 7 - Jam nut receptacle

CLASS
T - Environment-resistant (without rear accessory)



Wall Mount Receptacle

D38999/20

KJA0T**

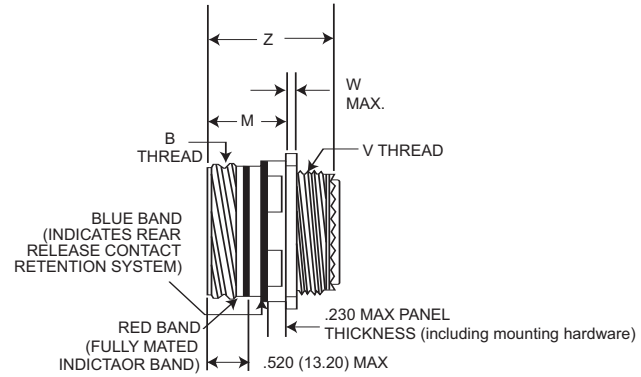
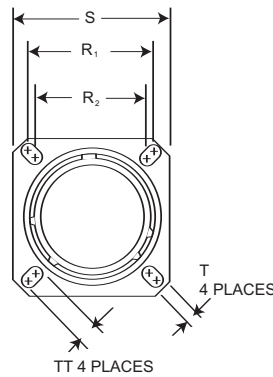

| Shell Size | MS Shell size Code | B Thread Class 2A (Plated) | M +.000 (.000) -.005 (.130) | R 1 | R 2 | S +.012 (.300) | T +.004 (.100) -.002 (.050) | TT +.004 (.100) -.002 (.050) | Metric V Thread (Plated) | W Max. | Z +.005 (.130) -.010 (.250) |
|------------|--------------------|----------------------------|-----------------------------------|---------------|---------------|-------------------|-----------------------------------|------------------------------------|--------------------------|-------------|-----------------------------------|
| 9 | A | .6250-0.1P-0.3L-TS | .820 (20.83) | .719 (18.26) | .594 (15.09) | .938 (23.83) | .128 (3.25) | .216 (5.49) | M12X1-6g0.100R | .098 (2.50) | 1.235 (31.36) |
| 11 | B | .7500-0.1P-0.3L-TS | .820 (20.83) | .812 (20.62) | .719 (18.26) | 1.031 (26.19) | .128 (3.25) | .194 (4.93) | M15X1-6g0.100R | .098 (2.50) | 1.235 (31.36) |
| 13 | C | .8750-0.1P-0.3L-TS | .820 (20.83) | .906 (23.01) | .812 (20.62) | 1.125 (28.58) | .128 (3.25) | .194 (4.93) | M18X1-6g0.100R | .098 (2.50) | 1.235 (31.36) |
| 15 | D | 1.0000-0.1P-0.3L-TS | .820 (20.83) | .969 (24.61) | .906 (23.01) | 1.219 (30.96) | .128 (3.25) | .173 (4.39) | M22X1-6g0.100R | .098 (2.50) | 1.235 (31.36) |
| 17 | E | 1.1875-0.1P-0.3L-TS | .820 (20.83) | 1.062 (26.97) | .969 (24.61) | 1.312 (33.32) | .128 (3.25) | .194 (4.93) | M25X1-6g0.100R | .098 (2.50) | 1.235 (31.36) |
| 19 | F | 1.2500-0.1P-0.3L-TS | .820 (20.83) | 1.156 (29.36) | 1.062 (26.97) | 1.438 (36.53) | .128 (3.25) | .194 (4.93) | M28X1-6g0.100R | .098 (2.50) | 1.235 (31.36) |
| 21 | G | 1.3750-0.1P-0.3L-TS | .790 (20.07) | 1.250 (31.75) | 1.156 (29.36) | 1.562 (39.67) | .128 (3.25) | .194 (4.93) | M31X1-6g0.100R | .126 (3.20) | 1.235 (31.36) |
| 23 | H | 1.5000-0.1P-0.3L-TS | .790 (20.07) | 1.375 (34.92) | 1.250 (31.75) | 1.688 (42.88) | .154 (3.91) | .242 (6.15) | M34X1-6g0.100R | .126 (3.20) | 1.235 (31.36) |
| 25 | J | 1.6250-0.1P-0.3L-TS | .790 (20.07) | 1.500 (38.10) | 1.375 (34.92) | 1.812 (46.02) | .154 (3.91) | .242 (6.15) | M37X1-6g0.100R | .126 (3.20) | 1.235 (31.36) |

Straight Plug Grounded

D38999/26

KJA6T**

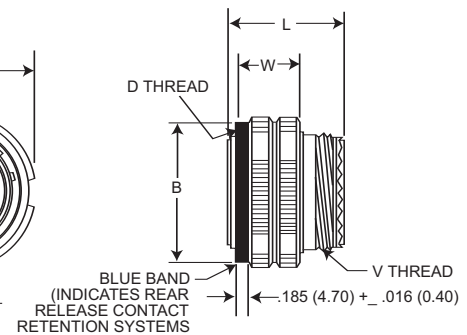
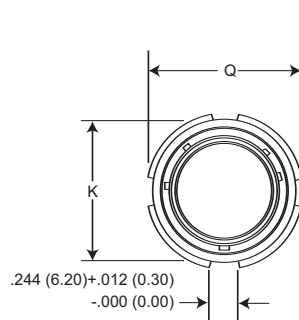

| Shell Size | MS Shell size Code | B +.008 (.200) -.000 (.000) | D Thread Class 2B (Plated) | K Max. | L Max. | Q Dia Max. | Metric V Thread (Plated) | W +.008 (.200) -.004 (.100) |
|------------|--------------------|-----------------------------------|----------------------------|---------------|---------------|---------------|--------------------------|-----------------------------------|
| 9 | A | .724 (18.40) | .6250-0.1P-0.3L-TS | .748 (19.00) | 1.234 (31.34) | .859 (21.82) | M12X1-6g0.100R | .760 (19.30) |
| 11 | B | .831 (21.10) | .7500-0.1P-0.3L-TS | .862 (21.90) | 1.234 (31.34) | .969 (24.61) | M15X1-6g0.100R | .760 (19.30) |
| 13 | C | 1.000 (25.40) | .8750-0.1P-0.3L-TS | 1.027 (26.10) | 1.234 (31.34) | 1.141 (28.98) | M18X1-6g0.100R | .760 (19.30) |
| 15 | D | 1.130 (28.70) | 1.0000-0.1P-0.3L-TS | 1.153 (29.30) | 1.234 (31.34) | 1.266 (32.16) | M22X1-6g0.100R | .760 (19.30) |
| 17 | E | 1.268 (32.20) | 1.1875-0.1P-0.3L-TS | 1.291 (32.80) | 1.234 (31.34) | 1.391 (35.53) | M25X1-6g0.100R | .760 (19.30) |
| 19 | F | 1.374 (34.90) | 1.2500-0.1P-0.3L-TS | 1.398 (35.50) | 1.234 (31.34) | 1.500 (38.10) | M28X1-6g0.100R | .760 (19.30) |
| 21 | G | 1.500 (38.10) | 1.3750-0.1P-0.3L-TS | 1.524 (38.70) | 1.234 (31.34) | 1.625 (41.28) | M31X1-6g0.100R | .760 (19.30) |
| 23 | H | 1.618 (41.40) | 1.5000-0.1P-0.3L-TS | 1.642 (41.70) | 1.234 (31.34) | 1.750 (44.45) | M34X1-6g0.100R | .760 (19.30) |
| 25 | J | 1.744 (44.30) | 1.6250-0.1P-0.3L-TS | 1.768 (44.90) | 1.234 (31.34) | 1.875 (47.62) | M37X1-6g0.100R | .760 (19.30) |

Performance Specifications-Pages 3-4

Contacts, Sealing Plugs, Assembly Tools - Pages 22, 27-28

Contact Arrangements - Pages 20-21

Dimensions shown in mm

Specifications and dimensions subject to change

www.ittcannon.com



Jam Nut Receptacle

D38999/24

KJA7T***

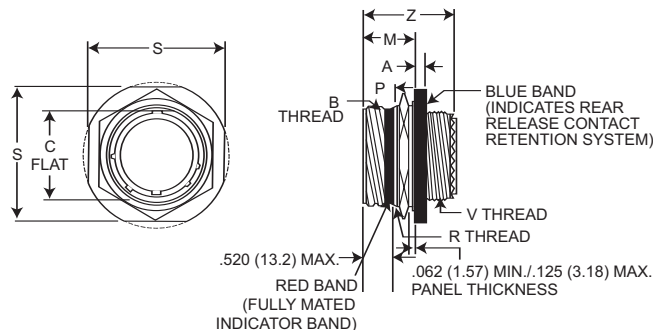
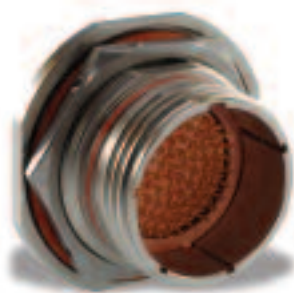

| Shell Size | MS Shell size Code | A +.010 (.250) -.005 (.130) | B Thread Class 2A (Plated) | C +.004 (.100) -.010 (.250) | Z +.005 (.130) -.040 (.100) | M +.005 (.130) -.004 (.100) | P +.016 (.410) -.004 (.100) | S | Metric R Thread (Plated) | Metric V Thread (Plated) |
|------------|--------------------|-----------------------------------|----------------------------------|-----------------------------------|-----------------------------------|-----------------------------------|-----------------------------------|---------------|-----------------------------|-----------------------------|
| 9 | A | .104 (2.64) | .6250-0.1P-0.3L-TS | .651 (16.53) | 1.243 (31.57) | .871 (22.12) | .555 (14.10) | 1.062 (26.97) | M17X1-6g0.100R | M12X1-6g0.100R |
| 11 | B | .104 (2.64) | .7500-0.1P-0.3L-TS | .751 (19.07) | 1.243 (31.57) | .871 (22.12) | .555 (14.10) | 1.250 (31.75) | M20X1-6g0.100R | M15X1-6g0.100R |
| 13 | C | .104 (2.64) | .8750-0.1P-0.3L-TS | .938 (23.82) | 1.243 (31.57) | .878 (22.30) | .563 (14.30) | 1.375 (34.92) | M25X1-6g0.100R | M18X1-6g0.100R |
| 15 | D | .104 (2.64) | 1.0000-0.1P-0.3L-TS | 1.062 (26.97) | 1.243 (31.57) | .878 (22.30) | .563 (14.30) | 1.500 (38.10) | M28X1-6g0.100R | M22X1-6g0.100R |
| 17 | E | .104 (2.64) | 1.1875-0.1P-0.3L-TS | 1.187 (30.15) | 1.243 (31.57) | .878 (22.30) | .563 (14.30) | 1.625 (41.28) | M32X1-6g0.100R | M25X1-6g0.100R |
| 19 | F | .135 (3.43) | 1.2500-0.1P-0.3L-TS | 1.312 (33.32) | 1.243 (31.57) | .878 (22.30) | .563 (14.30) | 1.812 (46.02) | M35X1-6g0.100R | M28X1-6g0.100R |
| 21 | G | .135 (3.43) | 1.3750-0.1P-0.3L-TS | 1.437 (36.50) | 1.243 (31.57) | .878 (22.30) | .563 (14.30) | 1.938 (49.23) | M38X1-6g0.100R | M31X1-6g0.100R |
| 23 | H | .135 (3.43) | 1.5000-0.1P-0.3L-TS | 1.562 (39.67) | 1.243 (31.57) | .878 (22.30) | .563 (14.30) | 2.062 (52.37) | M41X1-6g0.100R | M34X1-6g0.100R |
| 25 | J | .135 (3.43) | 1.6250-0.1P-0.3L-TS | 1.687 (42.85) | 1.243 (31.57) | .878 (22.30) | .563 (14.30) | 2.188 (55.38) | M44X1-6g0.100R | M37X1-6g0.100R |

Performance Specifications-Pages 3-4

Contacts, Sealing Plugs, Assembly Tools - Pages 22, 27-28

Contact Arrangements - Pages 20-21

Panel Cutouts

Wall Mounted Receptacle

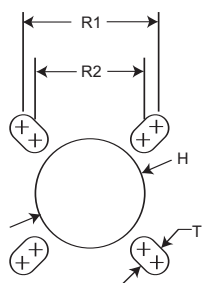

Jam Nut Receptacle

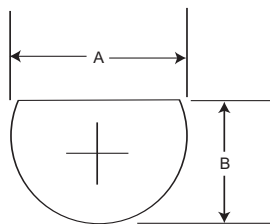

| Shell Size | A +.010 (.25) -.000 (.00) | B +.000 (.00) -.010 (.25) | H +.010 (.25) -.000 (.00) | R1 (TP) | R2 (TP) | T (Max.) |
|------------|---------------------------------|---------------------------------|---------------------------------|---------------|---------------|-------------|
| 9 | .700 (17.78) | .670 (17.02) | .626 (15.90) | .719 (18.26) | .594 (15.09) | .134 (3.40) |
| 11 | .825 (20.96) | .771 (19.58) | .751 (19.08) | .812 (20.62) | .719 (18.26) | .134 (3.40) |
| 13 | 1.010 (25.65) | .955 (24.26) | .876 (22.25) | .906 (23.01) | .812 (20.62) | .134 (3.40) |
| 15 | 1.135 (28.83) | 1.085 (27.56) | 1.001 (25.43) | .969 (24.61) | .906 (23.01) | .134 (3.40) |
| 17 | 1.260 (32.00) | 1.210 (30.73) | 1.188 (30.18) | 1.062 (26.97) | .969 (24.61) | .134 (3.40) |
| 19 | 1.385 (35.18) | 1.335 (33.91) | 1.251 (31.78) | 1.156 (29.36) | 1.062 (26.97) | .134 (3.40) |
| 21 | 1.510 (38.35) | 1.460 (37.08) | 1.376 (34.95) | 1.250 (31.75) | 1.156 (29.36) | .134 (3.40) |
| 23 | 1.635 (41.53) | 1.585 (40.26) | 1.511 (38.38) | 1.375 (34.92) | 1.250 (31.75) | .160 (4.06) |
| 25 | 1.760 (44.70) | 1.710 (43.43) | 1.626 (41.30) | 1.500 (38.10) | 1.375 (34.92) | .160 (4.06) |



Dimensions shown in mm
Specifications and dimensions subject to change

www.ittcannon.com

Polarizing Positions

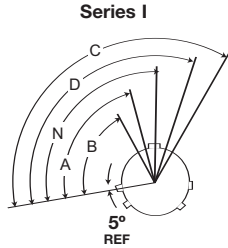

Front face of receptacle (plug opposite). Insert arrangement does not rotate with main key-keyway. The master key is rotated to provide shell polarization; the minor keys remain fixed.

| Shell Size | Angle of Rotation (Degrees) | | | | |
|------------|-----------------------------|-----|-----|------|------|
| | Normal | A | B | C | D |
| 9 | 95° | 77° | | | 113° |
| 11 | 95° | 81° | 67° | 123° | 109° |
| 13 | 95° | 75° | 63° | 127° | 115° |
| 15 | 95° | 74° | 61° | 129° | 116° |
| 17 | 95° | 77° | 65° | 125° | 113° |
| 19 | 95° | 77° | 65° | 125° | 113° |
| 21 | 95° | 77° | 65° | 125° | 113° |
| 23 | 95° | 80° | 69° | 121° | 110° |
| 25 | 95° | 80° | 69° | 121° | 110° |

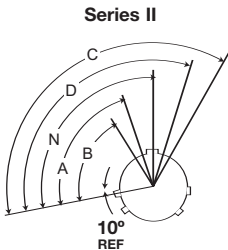

Front face of receptacle (plug opposite). Insert arrangement does not rotate with main key-keyway. The master key is rotated to provide shell polarization; the minor keys remain fixed.

| Shell Size | Angle of Rotation (Degrees) | | | | |
|------------|-----------------------------|-----|-----|------|------|
| | Normal | A | B | C | D |
| 8 | 100° | 82° | | | 118° |
| 10 | 100° | 86° | 72° | 128° | 114° |
| 12 | 100° | 80° | 68° | 132° | 120° |
| 14 | 100° | 79° | 66° | 134° | 121° |
| 16 | 100° | 82° | 70° | 130° | 118° |
| 18 | 100° | 82° | 70° | 130° | 118° |
| 20 | 100° | 82° | 70° | 130° | 118° |
| 22 | 100° | 85° | 74° | 126° | 115° |
| 24 | 100° | 85° | 74° | 126° | 115° |

Series III

RECEPTACLE
(Front face shown)

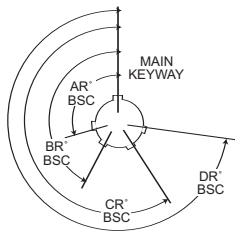

PLUG
(Front face shown)

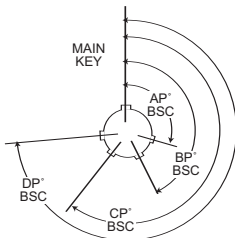

NOTES

- All Angles are BSC
- The insert arrangement does not rotate with main key/keyway
- All minor keys are rotated to provide shell polarization, the master key remains fixed at twelve o'clock position.
- Polarization is different from Series I and II.

| Shell Size | Key & Keyway Arrangement identification Letter | Key Locations | | | |
|------------|--|----------------|----------------|----------------|----------------|
| | | AR° or AP° BSC | BR° or BP° BSC | CR° or CP° BSC | DR° or DP° BSC |
| 9 | N | 105 | 140 | 215 | 265 |
| | A | 102 | 132 | 248 | 320 |
| | B | 80 | 118 | 230 | 312 |
| | C | 35 | 140 | 205 | 275 |
| | D | 64 | 155 | 234 | 304 |
| 11 | E | 91 | 131 | 197 | 240 |
| | N | 95 | 141 | 208 | 236 |
| | A | 113 | 156 | 182 | 292 |
| | B | 90 | 145 | 195 | 252 |
| | C | 53 | 156 | 220 | 255 |
| 13 and 15 | D | 119 | 146 | 176 | 298 |
| | E | 51 | 141 | 184 | 242 |
| | N | 80 | 142 | 196 | 293 |
| 17 and 19 | A | 135 | 170 | 200 | 310 |
| | B | 49 | 169 | 200 | 244 |
| | C | 66 | 140 | 200 | 257 |
| 21 and 23 | D | 62 | 145 | 180 | 280 |
| | E | 79 | 153 | 197 | 272 |
| | N | 80 | 142 | 196 | 293 |
| | A | 135 | 170 | 200 | 310 |
| | B | 49 | 169 | 200 | 244 |
| 25 | C | 66 | 140 | 200 | 257 |
| | D | 62 | 145 | 180 | 280 |
| | E | 79 | 153 | 197 | 272 |











Contact Arrangements (Engaging View Pin Insert)









* Socket insert only



** Pin insert only (Not available in socket insert Series I and III)

Indicates layouts are available in all shell styles including MS27499, MS27508, KJ2E and KJ5E

• Consult factory MS27505E/KJL5E insert availability

| | | | | | | | | | | |
|-----------------|---|---|---|---|---|--|---|---|---|---|
| |  |  |  |  |  |  |  |  |  |  |
| Series III | 9-98 | 9-35 | - | 11-5 | 11-98 | - | 11-35 | - | - | 13-8 |
| Series II | 8-98† | 8-35† | - | 10-5† | 10-98† | - | 10-35† | - | - | 12-8† |
| Series I | 9-98 | 9-35 | 11-4 | 11-5 | 11-98 | 10-99† | 10-35† | 12-3 | 12-4† | 12-8† |
| No. of Contacts | 3 #20 | 6 #22D | 4 #20 | 5 #20 | 6 #20 | 7 #20 | 13 #22D | 3 #16 | 4 #16 | 8 #20 |
| Service Ratings | I | M | I | I | I | I | M | II | I | I |

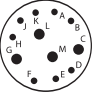
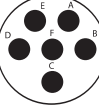
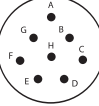
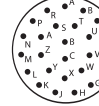
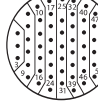
| | | | | | | | | |
|-----------------|---|---|---|---|---|---|---|---|
| |  |  |  |  |  |  |  |  |
| Series III | 13-98 | 13-35 | 15-5 | 15-15 | 15-15 | 15-18 | 15-19 | 15-35 |
| Series II | 12-98† | 12-35† | 14-5† | 14-15† | 14-18† | 14-18† | - | 14-35† |
| Series I | 13-98 | 13-35 | 15-5 | 15-15 | 15-18 | 15-18 | 15-19 | 15-35 |
| No. of Contacts | 10 #20 | 22 #22D | 5 #16 | 14 #20, 1 #16 | 18 #20 | 18 #20 | 19 #20 | 37 #22D |
| Service Ratings | I | M | II | I | I | I | I | M |

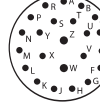
| | | | | | | | |
|-----------------|---|---|---|---|---|---|---|
| |  |  |  |  |  |  |  |
| Series III | 15-97 | 17-6 | 17-8 | 17-26 | 17-35 | - | - |
| Series II | 14-97† | 16-6 | 16-8† | 16-26† | 16-35† | 16-42† | 16-99† |
| Series I | 15-97 | 17-6 | 17-8 | 17-26 | 17-35 | 42 #22 | 17-99** |
| No. of Contacts | 8 #20, 4 #16 | 6 #12 | 8 #16 | 26 #20 | 55 #22D | M | 21 #20, 2 #16 |
| Service Ratings | I | I | II | I | M | M | I |

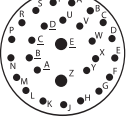
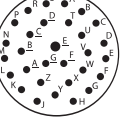
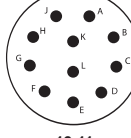
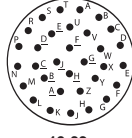
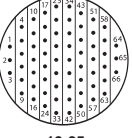
| | | | | | |
|-----------------|---|---|---|---|---|
| |  |  |  |  |  |
| Series III | - | - | 19-11 | 19-32 | 19-35 |
| Series II | 18-28 | 18-30 | 18-11 | 18-32† | 18-35† |
| Series I | 19-28** | 19-30** | 19-11 | 19-32 | 19-35 |
| No. of Contacts | 26 #20, 2 #16 | 29 #20, 1 #16 | 11 #16 | 32 #20 | 66 #22D |
| Service Ratings | I | I | II | I | M |

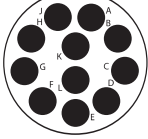
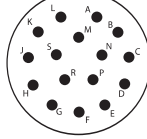
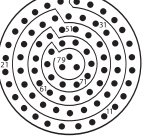
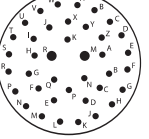
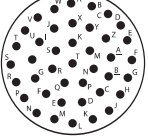
| | | | | | |
|-----------------|---|---|---|---|---|
| |  |  |  |  |  |
| Series III | 21-11 | 21-16 | 21-35 | 21-39 | 21-41 |
| Series II | - | 20-16† | 20-35† | 20-39† | 20-41† |
| Series I | 21-11 | 21-16 | 21-35 | 21-39 | 21-41 |
| No. of Contacts | 11 #12 | 16 #16 | 79 #22D | 37 #20, 2 #16 | 41- #20 |
| Service Ratings | I | II | M | I | I |

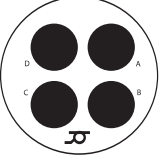
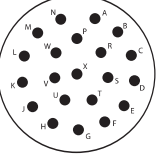
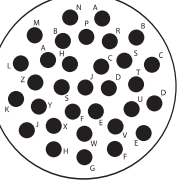
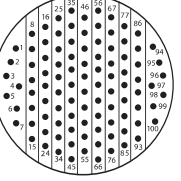
| | | | | |
|-----------------|---|---|--|---|
| |  |  |  |  |
| Series III | 21-75 | 23-21 | - | 23-35 |
| Series II | - | 22-21 | 22-32 | 22-35† |
| Series I | 21-75* | 23-21 | 23-32** | 23-35 |
| No. of Contacts | 4 #8 Twinax | 21 #16 | 32 #20 | 100 #22D |
| Service Ratings | M | II | I | M |

Please consult factory for availability of layouts not shown.







Contact Arrangements (Engaging View Pin Insert)

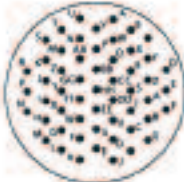
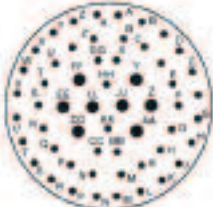

* Socket insert only

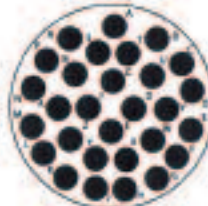

** Pin insert only (Not available in socket insert Series I and III)

† Indicates layouts are available in all shell styles including MS27499, MS27508, KJ2E and KJ5E
 • Consult factory for MS27505E/KJL5E insert availability

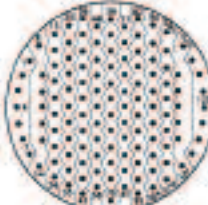
| | | | |
|--|--|--|--|
| <p>Series III Series II Series I No. of Contacts Service Ratings</p> |  23-53 22-53† 23-53 53 #20 I |  23-55 22-55† 23-55 55 #20 I |  25-4 24-4† 25-4 46 #20, 6 #16 I |
|--|--|--|--|

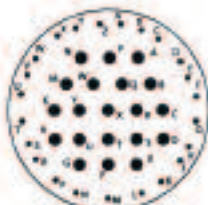
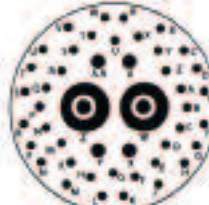
| | | | | | |
|--|--|--|---|--|--|
| <p>Series III Series II Series I No. of Contacts Service Ratings</p> |  25-8 25-8* 3 #8 Twinnax Twinnax I |  25-19 25-19 19 #12 I |  25-20 25-20* 3 #8 Twinnax, 13 #16, 4 #12 Coax, 10 #20 N / Coax / Twinnax I |  25-24 24-24† 25-24 12 #16, 12 #12 I |  25-29 24-29† 25-29 29 #16 I |
|--|--|--|---|--|--|

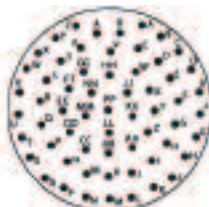
| | | | | | |
|--|--|---|---|--|---|
| <p>Series III Series II Series I No. of Contacts Service Ratings</p> |  25-35 24-35† 25-35 128 #22D M |  25-37 25-37* 37 #16 I |  25-42 25-42* 30 #20, 4 #8 Coax I, Coax |  25-43 25-43 23 #20, 20 #16 I |  25-46 25-46 40 #20, 4 #16, 2 #8 Twinnax |
|--|--|---|---|--|---|

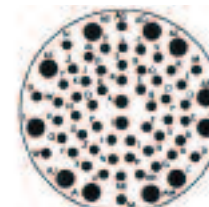
| | | | |
|---|--|---|--|
| <p>Series III Series II Series I No. of Contacts Service Rating</p> |  25-61 24-61† 25-61 61 #20 I |  25-64* 25-64* 40 #22D, 8 #28 19 #16, 8 #12 I |  25-66* 25-66* 53 #22D, 2 #20, 11 #16 I |
|---|--|---|--|

Contacts-Pin (Series I/II/III)

MIL-C-39029/58

KJL/KJ/KJA

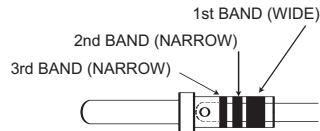

| Contact Size | 1 | Color Bands 2 | 3 | Cannon Part Number | M39029 Military Part Number |
|--------------|--------|---------------|--------|--------------------|-----------------------------|
| 22D | Orange | Blue | Black | 980-0008-878 | M39029/58-360 |
| 20 | Orange | Blue | Orange | 980-0008-879 | M39029/58-363 |
| 16 | Orange | Blue | Yellow | 980-0008-880 | M39029/58-364 |
| 12 | Orange | Blue | Green | 980-0008-881 | M39029/58-365 |

| Contact Size | Cannon Part Number | Cable Accomodations |
|--------------|--------------------|---------------------|
| 8 Coax | 249-2196-000 | RG-180 |
| | 249-2196-001 | RG-174, 179, 316 |
| | 249-2196-002 | RG-142 |
| 8 Twinax | 980-1000-012 | M17/176-00002 |
| 12 Coax | 980-1000-016 | RG-174, 179, 316 |

Contacts-Socket (Series II)

MIL-C-39029/57

KJ

Manufacture identification Code Area - Typical all contacts

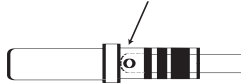

| Contact Size | 1 | Color Bands 2 | 3 | Cannon Part Number | M39029 Military Part Number |
|--------------|--------|---------------|--------|--------------------|-----------------------------|
| 22D | Orange | Green | Yellow | 980-0008-874 | M39029/57-354 |
| 20 | Orange | Green | Violet | 980-0008-875 | M39029/57-357 |
| 16 | Orange | Green | Gray | 980-0008-876 | M39029/57-358 |
| 12 | Orange | Green | White | 980-0008-877 | M39029/57-359 |

Contacts-Socket (Series I & III)

MIL-C-39029/56

KJL/KJA

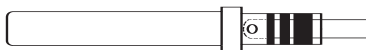

| Contact Size | 1 | Color Bands 2 | 3 | Cannon Part Number | M39029 Military Part Number |
|--------------|--------|---------------|--------|--------------------|-----------------------------|
| 22D | Orange | Yellow | Gray | 980-0008-870 | M39029/56-348 |
| 20 | Orange | Green | Brown | 980-0008-871 | M39029/56-351 |
| 16 | Orange | Green | Red | 980-0008-872 | M39029/56-352 |
| 12 | Orange | Green | Orange | 980-0008-873 | M39029/56-353 |

| Contact Size | Cannon Part Number | Cable Accomodations |
|--------------|--------------------|---------------------|
| 8 Coax | 249-2195-000 | RG-180 |
| | 249-2195-001 | RG-174, 179, 316 |
| | 249-2195-002 | RG-142 |
| 8 Twinax | 980-1000-013 | M17/176-00002 |
| 12 Coax | 980-1000-015 | RG-174, 179, 316 |

Contact Sealing Bushings

Size 8 Twinax Sealing Bushing 321-1035-000
Used with the Twinax contact in Twinax layouts for sealing cable size M17/176-00002

Size 8 Coax Sealing Bushing 321-1034-001
Used with the Coax contact in Twinax layouts for sealing cable size RG-180



Twinax Grommet



Coax Grommet

Contact Sealing Bushing Sequence into Twinax Grommet (Bushing only used with Twinax grommet)

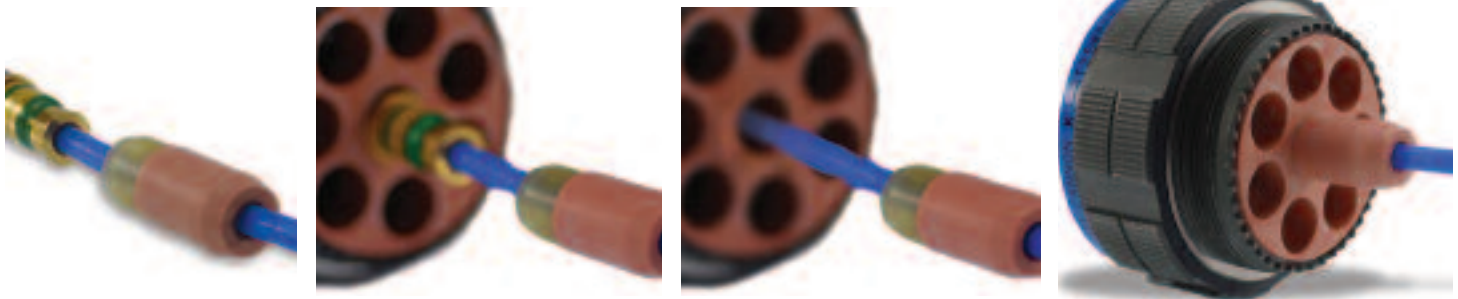

Contacts-Printed Circuit Board

PIN PRINTED CIRCUIT CONTACT EXTENSION FROM REAR OF CONNECTOR (MAX / MIN)

| PC CONTACT PART NUMBER | CONTACT SIZE | TAIL DIA. ±.001 | MS27466 MS27467 KJL0 / KJL6 | MS27656 MS27468 KJL3 / KJL7 | MS27505E KJL5E | MS27472 MS27474 KJ0 / KJ7 | MS27499E MS27508E KJ2E / KJ5E | MS27513E MS27497 / NO MS KJ2R / KJ3 / KJ5R | MS27473 MS27484 KJ6 / KJG6 | D38999/20 KJA0 | D38999/26 KJA6 | D38999/24 KJA7 (9-17) | D38999/24 KJA7 (19-25) |
|------------------------|--------------|-----------------|-----------------------------|-----------------------------|------------------|---------------------------|-------------------------------|--|----------------------------|----------------|----------------|-----------------------|------------------------|
| 030-2097-002 | 22D | 0.020 | 0.261 0.189 | 0.244 0.176 | 0.408 0.376 | 0.264 0.226 | 0.408 0.376 | 0.264 0.226 | 0.264 0.226 | 0.262 0.200 | 0.266 0.194 | 0.280 0.216 | 0.258 0.198 |
| 030-2097-006 | 22D | 0.020 | 0.069 N/A | 0.052 N/A | 0.216 0.184 | 0.072 0.034 | 0.216 0.184 | 0.072 0.034 | 0.072 0.034 | 0.070 0.008 | 0.074 0.002 | 0.088 0.024 | 0.066 0.006 |
| 030-2097-008 | 22D | 0.020 | 0.216 0.144 | 0.199 0.131 | 0.363 0.331 | 0.219 0.181 | 0.363 0.331 | 0.219 0.181 | 0.219 0.181 | 0.217 0.155 | 0.221 0.149 | 0.235 0.171 | 0.213 0.153 |
| 030-2097-015 | 22D | 0.020 | 0.293 0.221 | 0.276 0.208 | 0.440 0.408 | 0.296 0.258 | 0.440 0.408 | 0.296 0.258 | 0.296 0.258 | 0.294 0.232 | 0.298 0.226 | 0.312 0.248 | 0.290 0.230 |
| 030-1997-006 | 20 | 0.025 | 0.166 0.094 | 0.149 0.081 | 0.313 0.281 | 0.169 0.131 | 0.313 0.281 | 0.169 0.131 | 0.169 0.131 | 0.167 0.105 | 0.171 0.099 | 0.185 0.121 | 0.163 0.103 |
| 030-1997-022 | 20 | 0.025 | 0.281 0.209 | 0.264 0.196 | 0.428* 0.396* | 0.284 0.246 | 0.428* 0.396* | 0.284 0.246 | 0.284 0.246 | 0.282 0.220 | 0.286 0.214 | 0.300 0.236 | 0.278 0.218 |
| 030-1997-030 | 20 | 0.019 | 0.364 0.292 | 0.347 0.279 | 0.511 0.479 | 0.367 0.329 | 0.511 0.479 | 0.367 0.329 | 0.367 0.329 | 0.365 0.303 | 0.369 0.297 | 0.383 0.319 | 0.361 0.301 |
| 030-1995-023 | 16 | 0.062 | 0.278 0.206 | 0.261 0.193 | 0.425 0.393 | 0.281 0.243 | 0.425 0.393 | 0.281 0.243 | 0.281 0.243 | 0.279 0.217 | 0.283 0.211 | 0.297 0.233 | 0.275 0.215 |
| 030-1995-024 | 16 | 0.062 | 0.118 0.046 | 0.101 0.033 | 0.265 0.233 | 0.121 0.083 | 0.265 0.233 | 0.121 0.083 | 0.121 0.083 | 0.119 0.057 | 0.123 0.051 | 0.137 0.073 | 0.115 0.055 |

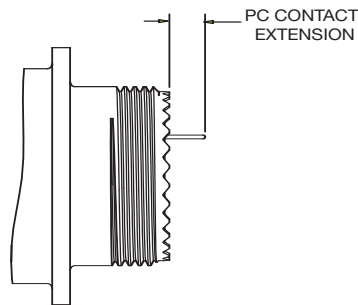

(KJL0/3/6/7 & KJA0/6/7)

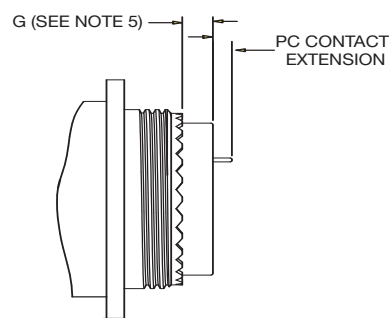

(KJL5E, KJ0/2E/2R/3/5E/5R/6/7, & KJG6)

SOCKET (SERIES II) PRINTED CIRCUIT CONTACT EXTENSION FROM REAR OF CONNECTOR (MAX / MIN)

| PC CONTACT PART NUMBER | CONTACT SIZE | TAIL DIA. ±.001 | MS27472 MS27474 KJ0 / KJ7 | MS27499E MS27508E KJ2E / KJ5E | MS27513E MS27497 / NO MS KJ2R / KJ3 / KJ5R | MS27473 MS27484 KJ6 / KJG6 |
|------------------------|--------------|-----------------|---------------------------|-------------------------------|--|----------------------------|
| 031-1186-006 | 22D | 0.020 | 0.179 0.141 | 0.323 0.291 | 0.179 0.141 | 0.179 0.141 |
| 031-1186-011 | 22D | 0.020 | 0.109 0.071 | 0.253 0.221 | 0.109 0.071 | 0.109 0.071 |
| 031-1186-013 | 22D | 0.020 | 0.217 0.179 | 0.361 0.329 | 0.217 0.179 | 0.217 0.179 |
| 031-1186-021 | 22D | 0.020 | 0.262 0.224 | 0.406 0.374 | 0.262 0.224 | 0.262 0.224 |
| 031-1124-021 | 20 | 0.025 | 0.247 0.209 | 0.391* 0.359* | 0.247 0.209 | 0.247 0.209 |
| 031-1123-007 | 16 | 0.062 | 0.101 0.063 | 0.245 0.213 | 0.101 0.063 | 0.101 0.063 |

SOCKET (SERIE I & III) PRINTED CIRCUIT CONTACT EXTENSION FROM REAR OF CONNECTOR (MAX / MIN)

| PC CONTACT PART NUMBER | CONTACT SIZE | TAIL DIA. ±.001 | MS27466 MS27467 KJL0 / KJL6 | MS27656 MS27468 KJL3 / KJL7 | MS27505E KJL5E | D38999/20 KJA0 | D38999/26 KJA6 | D38999/24 KJA7 (9-17) | D38999/24 KJA7 (19-25) |
|------------------------|--------------|-----------------|-----------------------------|-----------------------------|------------------|----------------|----------------|-----------------------|------------------------|
| 031-1147-014 | 22D | 0.021 | 0.244 0.172 | 0.227 0.159 | 0.391* 0.359* | 0.245 0.183 | 0.249 0.177 | 0.263 0.199 | 0.241 0.181 |
| 031-1147-039 | 22D | 0.020 | 0.168 0.096 | 0.151 0.083 | 0.315* 0.283* | 0.169 0.107 | 0.173 0.101 | 0.187 0.123 | 0.165 0.105 |
| 031-1147-040 | 22D | 0.020 | 0.438 0.366 | 0.421 0.353 | 0.585* 0.553* | 0.439 0.377 | 0.443 0.371 | 0.457 0.393 | 0.435 0.375 |
| 031-1124-040 | 20 | 0.025 | 0.486 0.414 | 0.469 0.401 | 0.633 0.601 | 0.487 0.425 | 0.491 0.419 | 0.505 0.441 | 0.483 0.423 |
| 031-1123-020 | 16 | 0.029 | 0.272 0.200 | 0.255 0.187 | 0.419 0.387 | 0.273 0.211 | 0.277 0.205 | 0.291 0.227 | 0.269 0.209 |

NOTES: UNLESS OTHERWISE SPECIFIED.

- PC CONTACTS HAVE GOLD PLATING OVER SUITABLE UNDERPLATE PER MIL-C-39029 SPECIFICATION.
- PC CONTACT EXTENSIONS APPLY TO ITT CANNON CONNECTORS ONLY FOR ALL SHELL SIZES.
- N/A INDICATES NO EXTENSION.
- * INDICATES PC TAIL WITH SHANK EXTENDING FROM REAR OF CONNECTOR.
- G DIM. IS .031 +/- .016 FOR KJL5E AND .120 +/- .030 (SHELL SIZES 8 THRU 22) AND .090 +/- .050 (SHELL SIZE 24) FOR KJ0/2E/2R/3/5E/5R/6/7 & KJG6.
- FOR OTHER SPECIFIC PC CONTACT DATA, CONSULT ITT EC, SANTA ANA, CA, USA.



Dimensions shown in mm
Specifications and dimensions subject to change

www.ittcannon.com

Wire Sizes and Diameters

| Contact Size | Wire size (AWG) | Finished wire outside dimensions | |
|--------------|-----------------|----------------------------------|---------|
| | | Minimum | Maximum |
| 22D | 28, 26, 24, 22 | 0.030 | 0.054 |
| 22M* | 28, 26, 24 | 0.030 | 0.050 |
| 22* | 26, 24, 22 | 0.034 | 0.060 |
| 20 | 24, 22, 20 | 0.040 | 0.083 |
| 16 | 20, 18, 16 | 0.065 | 0.109 |
| 12 | 14, 12 | 0.097 | 0.142 |
| 8 Coax | RG-180 | 0.136 | 0.146 |
| 8 Twinax | M17/176-00002 | 0.124 | 0.134 |
| 12 Coax | RG174, 179, 316 | 0.094 | 0.102 |

*For reference only

Recommended Jam Nut Torque Values

| Series II | | Series I & III | |
|------------|-------------|----------------|-------------|
| Shell Size | Inch-Pounds | Shell Size | Inch-Pounds |
| 8 | 46/50 | 9 | 30/36 |
| 10 | 55/60 | 11 | 40/46 |
| 12 | 70/75 | 13 | 55/60 |
| 14 | 80/85 | 15 | 70/75 |
| 16 | 90/95 | 17 | 80/85 |
| 18 | 100/110 | 19 | 90/95 |
| 20 | 110/120 | 21 | 100/110 |
| 22 | 120/130 | 23 | 110/120 |
| 24 | 140/150 | 25 | 120/130 |

Coupling Nut Torque Values (Series I, II and III)

| Maximum engagement and disengagement | | Minimum disengagement | |
|--------------------------------------|------------|-----------------------|------------|
| Shell Size | Inch Pound | Shell Size | Inch Pound |
| 8 | 8 | 8 | 2 |
| 9 | 8 | 9 | 2 |
| 10 | 12 | 10 | 2 |
| 11 | 12 | 11 | 2 |
| 12 | 16 | 12 | 2 |
| 13 | 16 | 13 | 2 |
| 14 | 20 | 14 | 4 |
| 15 | 20 | 15 | 3 |
| 16 | 24 | 16 | 4 |
| 17 | 24 | 17 | 3 |
| 18 | 28 | 18 | 5 |
| 19 | 28 | 19 | 3 |
| 20 | 32 | 20 | 6 |
| 21 | 32 | 21 | 5 |
| 22 | 36 | 22 | 7 |
| 23 | 36 | 23 | 5 |
| 24 | 36 | 24 | 7 |
| 25 | 40 | 25 | 5 |

Backshell - Type E (Straight), Series II only

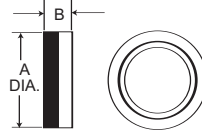

| Shell Size | | |
|------------|---------------|-------------|
| Series II | A Dia. Max. | B Dia. Max. |
| 8 | .580 (14.73) | .328 (8.33) |
| 10 | .705 (17.91) | .328 (8.33) |
| 12 | .830 (21.08) | .328 (8.33) |
| 14 | .955 (24.26) | .328 (8.33) |
| 16 | 1.080 (27.32) | .328 (8.33) |
| 18 | 1.205 (30.61) | .328 (8.33) |
| 20 | .330 (33.78) | .328 (8.33) |
| 22 | 1.455 (36.96) | .328 (8.33) |
| 24 | 1.555 (39.50) | .270 (6.86) |

How To Order

| Shell Size | Finishes | | | |
|------------|----------------------------------|--------------------------------|------------------------------|--------------------------------|
| | A | B | C | N |
| Series II | Cadmium/Nickel-Clear Part Number | Cadmium/Nickel-O.D Part Number | Anodic Non-Cond. Part Number | Electroless Nickel Part Number |
| 8 | 057-0776-000 | 057-0862-000 | 057-0819-000 | 057-0776-002 |
| 10 | 057-0777-000 | 057-0863-000 | 057-0820-000 | 057-0777-002 |
| 12 | 057-0778-000 | 057-0864-000 | 057-0821-000 | 057-0778-002 |
| 14 | 057-0779-000 | 057-0846-000 | 057-0822-000 | 057-0779-002 |
| 16 | 057-0780-000 | 057-0847-000 | 057-0823-000 | 057-0780-002 |
| 18 | 057-0781-000 | 057-0848-000 | 057-0824-000 | 057-0781-002 |
| 20 | 057-0782-000 | 057-0849-000 | 057-0825-000 | 057-0782-002 |
| 22 | 057-0783-000 | 057-0850-000 | 057-0826-000 | 057-0783-002 |
| 24 | 057-0784-000 | 057-0851-000 | 057-0827-000 | 057-0784-002 |

Backshell - Type F (Cable Clamp)

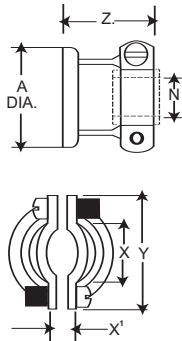

| Shell Size | | | | | | | |
|------------|-----------|---------------|--------------|--------------|--------------|---------------|--------------|
| Series I | Series II | A Max. | N Dia. Max. | X Dia. Min. | X' Dia. Min. | Y Max. | Z Max. |
| 9 | 8 | .508 (14.73) | .135 (3.43) | .234 (5.94) | .187 (4.75) | .829 (21.06) | .813 (20.65) |
| 11 | 10 | .705 (17.91) | .198 (5.03) | .297 (7.54) | .187 (4.75) | .891 (22.63) | .813 (20.65) |
| 13 | 12 | .830 (21.08) | .322 (7.18) | .422 (10.72) | .281 (7.14) | 1.016 (25.81) | .813 (20.65) |
| 15 | 14 | .955 (24.26) | .385 (9.78) | .547 (12.89) | .325 (8.26) | 1.141 (28.98) | .813 (20.65) |
| 17 | 16 | 1.080 (27.43) | .510 (12.95) | .609 (15.47) | .356 (9.04) | 1.203 (30.56) | .933 (23.70) |
| 19 | 18 | 1.205 (30.61) | .635 (16.13) | .734 (18.64) | .456 (11.58) | 1.469 (37.31) | .933 (23.70) |
| 21 | 20 | 1.330 (33.78) | .635 (16.13) | .734 (18.64) | .519 (13.18) | 1.469 (37.31) | .933 (23.70) |
| 23 | 22 | 1.455 (36.96) | .760 (19.30) | .922 (23.42) | .519 (13.18) | 1.656 (42.06) | .933 (23.70) |
| 25 | 24 | 1.555 (39.50) | .810 (20.57) | .984 (24.99) | .657 (16.69) | 1.750 (44.45) | .893 (22.68) |

How To Order (MS Version)

MS27506 - A - 8 - 2
Military Designation
 MS27506 Type F Straight with Cable Clamp
Finish
 A - Cad/Nickel (Clear)
 B - Cad/Nickel (O.D)
 F - Nickel (Electroless)
Shell Size
 Series I - 9, 11, 13, 15, 17, 19, 21, 23, 25
 Series II - 8, 10, 12, 14, 16, 18, 20, 22, 24
Adapter
 Geometry - 2

| Shell Size | | | | Finishes | | | | | |
|------------|-----------|----------------|--------------------|----------|----|--------|----|--------|----|
| Series I | Series II | MS Part Number | Cannon Part Number | A | | B | | N | F |
| | | | | Cannon | MS | Cannon | MS | Cannon | MS |
| 9 | 8 | 27506-*8-2 | 057-3005-*** | -012 | A | -013 | B | -015 | F |
| 11 | 10 | 27506-*10-2 | 057-3006-*** | -011 | A | -012 | B | -014 | F |
| 13 | 12 | 27506-*12-2 | 057-3007-*** | -012 | A | -013 | B | -015 | F |
| 15 | 14 | 27506-*14-2 | 057-3008-*** | -010 | A | -011 | B | -013 | F |
| 17 | 16 | 27506-*16-2 | 057-3009-*** | -012 | A | -013 | B | -015 | F |
| 19 | 18 | 27506-*18-2 | 057-3010-*** | -013 | A | -014 | B | -016 | F |
| 21 | 20 | 27506-*20-2 | 057-3011-*** | -011 | A | -013 | B | -015 | F |
| 23 | 22 | 27506-*22-2 | 057-3012-*** | -015 | A | -016 | B | -018 | F |
| 25 | 24 | 27506-*24-2 | 057-3013-*** | -013 | A | -014 | B | -017 | F |

* MS Finish *** Cannon Finish

Backshell - Type P (Potting Boot)

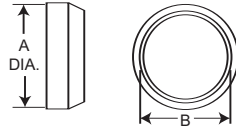

| Shell Size | | A Dia. Max. | B Dia. Max. |
|------------|-----------|---------------|---------------|
| Series I | Series II | | |
| 9 | 8 | .598 (15.19) | .434 (11.02) |
| 11 | 10 | .723 (18.36) | .548 (13.92) |
| 13 | 12 | .847 (21.51) | .673 (17.09) |
| 15 | 14 | .969 (24.61) | .798 (20.27) |
| 17 | 16 | 1.087 (27.61) | .899 (22.83) |
| 19 | 18 | 1.211 (30.76) | 1.024 (26.01) |
| 21 | 20 | 1.336 (33.93) | 1.141 (29.98) |
| 23 | 22 | 1.461 (37.11) | 1.274 (32.36) |
| 25 | 24 | 1.586 (40.28) | 1.399 (35.53) |

How To Order (MS Version)

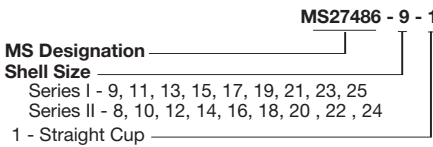

NOTE: When ordering the MS version you must specify both MS numbers for the Potting Boot and the Adapter Ring.

| Shell Size | | MS27486 Part Number | Cannon Part Number |
|------------|-----------|---------------------|--------------------|
| Series I | Series II | | |
| 9 | 8 | 27486**-1 | 040-0185-000 |
| 11 | 10 | 27486**-1 | 040-0169-000 |
| 13 | 12 | 27486**-1 | 040-0170-000 |
| 15 | 14 | 27486**-1 | 040-0171-000 |
| 17 | 16 | 27486**-1 | 040-0172-000 |
| 19 | 18 | 27486**-1 | 040-0173-000 |
| 21 | 20 | 27486**-1 | 040-0174-000 |
| 23 | 22 | 27486**-1 | 040-0175-000 |
| 25 | 24 | 27486**-1 | 040-0176-000 |

** Specify applicable Series I or II, shell size.

Potting Boot Adapter Ring

How To Order (MS Version)

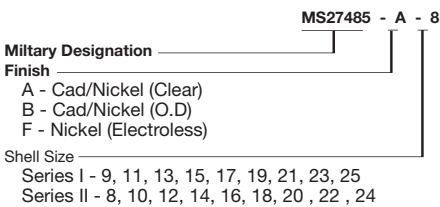

NOTE: When ordering the MS version you must specify both MS numbers for the Potting Boot and the Adapter Ring.

| Shell Size | | Finishes | | | | | | | |
|------------|-----------|---------------------|--------------------|-----------------------|----------|---------------------------|----|--------------------|-----------|
| Series I | Series II | MS27485 Part Number | Cannon Part Number | A | | B | | N | F |
| | | | | Cadmium/Nickel Cannon | Clear MS | Cadmium/Nickel-O.D Cannon | MS | Electroless Cannon | Nickel MS |
| 9 | 8 | 27485*-** | 237-0887-*** | -000 | A | -001 | B | -002 | F |
| 11 | 10 | 27485*-** | 237-0874-*** | -000 | A | -001 | B | -002 | F |
| 13 | 12 | 27485*-** | 237-0875-*** | -000 | A | -001 | B | -002 | F |
| 15 | 14 | 27485*-** | 237-0876-*** | -000 | A | -001 | B | -002 | F |
| 17 | 16 | 27485*-** | 237-0877-*** | -000 | A | -001 | B | -002 | F |
| 19 | 18 | 27485*-** | 237-0878-*** | -000 | A | -001 | B | -002 | F |
| 21 | 20 | 27485*-** | 237-0879-*** | -000 | A | -001 | B | -002 | F |
| 23 | 22 | 27485*-** | 237-0880-*** | -000 | A | -001 | B | -003 | F |
| 25 | 24 | 27485*-** | 237-0881-*** | -000 | A | -001 | B | -003 | F |

* MS Finish
 ** Specify applicable Series I or II shell size
 *** Cannon Finish

Wire Sealing Plugs

| Series III Size | Series I & II Size | Part Number | | Color Code |
|-----------------|--------------------|--------------|--------------|------------|
| | | Cannon | MS27488 | |
| 22D | 22D | 225-1013-000 | MS27488-22-1 | Black |
| 22M* | 22M* | 225-1013-000 | MS27488-22-1 | Black |
| - | 22* | 225-1013-000 | MS27488-22-1 | Black |
| 20 | 20 | 225-0070-000 | MS27488-20-1 | Red |
| 16 | 16 | 225-0071-000 | MS27488-16-1 | Blue |
| 12 | 12 | 225-0072-000 | MS27488-12-1 | Yellow |

Wire sealing plugs meet MS27488 standards. The plugs are color coded according to size for easy identification. Wire sealing plugs may be ordered separately.
 * For reference only

Tools - Crimp



M22520/1-01

CBT-530

M22520/2-01

CBT-565

| Contact Size | Pin Contact Series I/II/III | | Socket Contact Series II | | Socket Contact Series I & III | |
|--------------------------------|-----------------------------|-------------------------------|--------------------------|-------------------------------|-------------------------------|-------------------------------|
| | Crimp Tool Part Number | Locator or Turret Part Number | Crimp Tool Part Number | Locator or Turret Part Number | Crimp Tool Part Number | Locator or Turret Part Number |
| 22D or 22M* | M22520/2-01 | M22520/2-09 | M22520/2-01 | M22520/2-06 | M22520/2-01 | M22520/2-07 |
| 22* | M22520/2-01 | M22520/2-09 | M22520/2-01 | M22520/2-06 | M22520/2-01 | M22520/2-07 |
| 20 | M22520/1-01 | M22520/1-04 OR TH 187 | M22520/1-01 | M22520/1-04 | M22520/1-01 | M22520/1-04 |
| 16 | M22520/1-01 | M22520/1-04 OR TH 187 | M22520/1-01 | M22520/1-04 | M22520/1-01 | M22520/1-04 |
| 12 | M22520/1-01 | M22520/1-04 | M22520/1-01 | M22520/1-04 | M22520/1-01 | M22520/1-04 |
| 8 Coax Inner Conductor | Crimp Tool | Crimp Tool Locator | Outer Conductor | | Crimp Tool | Crimp Tool Locator |
| RG180 | M22520/2-01 | 995-002-268-268 | RG180 | | M22520/2-501 | M22520/2-5-39B |
| RG 174, 179, 310 | M22520/2-01 | 995-002-268-268 | RG 174, 179, 310 | | M22520/2-501 | M22520/2-5-37B |
| RG 142 | M22520/2-01 | 995-002-268-268 | RG 142 | | M22520/2-501 | M22520/2-5-19B |
| 12 Coax Inner Conductor | Crimp Tool | Crimp Tool Locator | Outer Conductor | | Crimp Tool | Crimp Tool Locator |
| RG174, 316 | M22520/2-01 | M22520/2-34 | RG174, 316 | | M22520/31-01 | M22520/ |
| 8 Twinax | Crimp Tool | Crimp Tool Locator | | | | |
| Center Contact | M22520/2-01 | K709 | | | | |
| Intermediate Contact | M22520/5-01 | Y631 Die Closure B | | | | |
| Outer Contact | M22520/5-01 | Y631 Die Closure A | | | | |

* For reference only

Tools - Plastic



Insertion/Extraction

| Contact Size | Cannon Description | Cannon Part Number | M81969 Part Number | Superseded Military Part Number | Insertion Color Tip | Extraction Color Tip |
|---------------|--------------------|--------------------|--------------------|---------------------------------|---------------------|----------------------|
| 22D | CIET-22D-01 | 274-7048-000 | M81969/14-01 | MS27534-22D | Green | White |
| 22M* | CIET-22D-01 | 274-7048-000 | M81969/14-01 | MS27534-22D | Green | White |
| 20 | CIET-20-10 | 274-7001-000 | M81969/14-10 | MS27534-20 | Red | Orange |
| 16 | CIET-16-03 | 274-7002-000 | M81969/14-03 | MS27534-16 | Blue | White |
| 12 | CIET-12-04 | 274-7003-000 | M81969/14-04 | MS27534-12 | Yellow | White |
| 8 Coax/Twinax | CET8-T | 323-7004-001 | — | — | — | — |
| 12 Coax | CIET-12-04 | 274-7003-000 | M81969/14-04 | MS27534-12 | Yellow | White |

Insertion tool not required for size 8

Tools - Metal (MS)



Insertion



Extraction

| Contact Size | Insertion | | | Extraction | | | |
|--------------|---------------------|------------------------|------------|---------------------|------------------------|------------|-------|
| | MS27495 Part Number | ITT CANNON Part Number | Color Band | MS27495 Part Number | ITT CANNON Part Number | Color Band | No.2 |
| 22D OR 22M* | MS27495 A22M | 995-0001-718 | Black | MS27495 R22M | 995-0001-719 | Black | White |
| 22* | MS27495 A22 | 995-0001-720 | Brown | MS27495 R22 | 995-0001-721 | Brown | White |
| 20 | MS27495 A20 | 995-0001-716 | Red | MS27495 R20 | 995-0001-717 | Red | White |
| 16 | MS27495 A16 | 995-0001-732 | Blue | MS27495 R16 | 995-0001-731 | Blue | White |

Band No. 1 indicates tool size.
Band No. 2 indicates removal tool.
* For reference only



Dimensions shown in mm
Specifications and dimensions subject to change

www.ittcannon.com

Assembly Instructions

Wire Stripping

Strip insulation from end of wire to be crimped. (See table for proper stripping dimensions.) Do not cut or damage wire strands.



| Wire Size | A |
|-------------|-------------|
| 22D or 22M* | .125 (3.18) |
| 20 | .188 (4.77) |
| 16 | .188 (4.77) |
| 12 | .188 (4.77) |

* For reference only

Contact Crimping

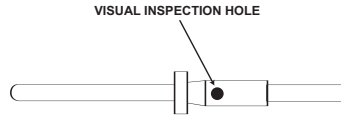

1. Insert stripped wire into contact crimp pot. Wire must be visible thru inspection hole.



2. Using correct crimp tool and locator, cycle the tool once to be sure the indentors are open. Insert contact and wire into locator. Squeeze tool handles firmly and completely to insure a proper crimp. The tool will not release unless the crimp indentors in the tool head have been fully actuated.



3. Release crimped contact and wire from tool. Be certain the wire is visible thru inspection hole in contact.

Contact Insertion



1. Remove hardware from plug or receptacle and slip over wire bundle in proper order for reassembly.



2. Using proper plastic or metal insertion tool for corresponding contact, position wire in tip of the tool so that the tool tip butts up against the contact shoulder.



3. Press tool against contact shoulder and, with firm and even pressure, insert wired contact and tool tip into center contact cavity. A slight click may be heard as metal retaining tines snap into place behind contact shoulder.



4. Remove tool and pull back lightly on wire to make sure contact is properly seated. Repeat operation with remainder of contacts to be inserted, beginning with the center cavity and working outward in alternating rows.



5. After all contacts are inserted, fill any empty cavities with wire sealing plugs, Resemble plug or receptacle hardware.

Contact Extraction



1. Remove hardware from plug or receptacle and slide hardware back along wire bundle.



2. Using plastic or metal extraction tool with proper color code corresponding to contact size, place wire in tool.



3. Insert tool into contact cavity until tool tip bottoms against the contact shoulder, expanding clip retaining tines.



4. Hold wire firmly in tool and extract wired contact and tool. Repeat operation for all contacts to be extracted.



5. Fill any empty wire cavities with wire sealing plugs, and



6. Reassemble plug or receptacle.

Dimensions shown in mm
Specifications and dimensions subject to change

MIL-DTL-38999 Series I, II, III Connectors

MIL-DTL-38999 Specifications

The following excerpts are some of the parameter requirements of the MIL-DTL-3899 Specification.

| Test Description | Paragraph Reference | Requirements | | | | | | | | | | | | | | | | | | | | | | | | | | | | | | | | | | | | | | | | | | | | | | | | | | | | | | | | | | | | | | | | | | | | | | | | |
|----------------------------|---|--|---|---|----------------------------|---|----------------------|---|-----------------------|---|------|--------|----|----|------------|------|------|------------|------|------|------------|------|------|------------|------|------|-----|---|---|----|----|---|----|----|---|----|----|---|-------|----|---|----|----|---|----|----|---|----|----|---|----|----|---|----|----|---|----|----|---|----|----|---|----|----|---|----|----|---|----|----|---|----|----|---|
| Contact Retention | 4 5 19 | After preloading to 3 pounds maximum, the force shall be applied at a rate of approximately 1 pound per second and maintained at full load for 5-10 seconds. No damage to contacts or insert shall result nor shall the contacts be dislocated from their normal position in the connector more than 0.012 inch under the given load. Failure to meet these requirements shall be cause for rejection. <table border="1" style="margin-left: auto; margin-right: auto;"> <thead> <tr> <th>Contact Size</th> <th>22M*</th> <th>22D</th> <th>22*</th> <th>20</th> <th>18</th> </tr> </thead> <tbody> <tr> <td>Loads in Pounds ± 10%</td> <td>10</td> <td>10</td> <td>10</td> <td>15</td> <td>25</td> </tr> </tbody> </table> | Contact Size | 22M* | 22D | 22* | 20 | 18 | Loads in Pounds ± 10% | 10 | 10 | 10 | 15 | 25 | | | | | | | | | | | | | | | | | | | | | | | | | | | | | | | | | | | | | | | | | | | | | | | | | | | | | | | | | | | | |
| Contact Size | 22M* | 22D | 22* | 20 | 18 | | | | | | | | | | | | | | | | | | | | | | | | | | | | | | | | | | | | | | | | | | | | | | | | | | | | | | | | | | | | | | | | | | | | | |
| Loads in Pounds ± 10% | 10 | 10 | 10 | 15 | 25 | | | | | | | | | | | | | | | | | | | | | | | | | | | | | | | | | | | | | | | | | | | | | | | | | | | | | | | | | | | | | | | | | | | | | |
| Coupling Torque | 4 5 6 | For qualification testing, mating halves shall be coupled and uncoupled, measuring the torques necessary. The torques required to couple and uncouple mating connector halves shall fall within the limits specifications as follows: <table border="1" style="margin-left: auto; margin-right: auto;"> <thead> <tr> <th colspan="3">Torque</th> <th colspan="3">Torque</th> <th colspan="3">Torque</th> <th colspan="3">Torque</th> </tr> <tr> <th>Shell Size</th> <th>Max.</th> <th>Min.</th> <th>Shell Size</th> <th>Max.</th> <th>Min.</th> <th>Shell Size</th> <th>Max.</th> <th>Min.</th> <th>Shell Size</th> <th>Max.</th> <th>Min.</th> </tr> </thead> <tbody> <tr> <td>8/9</td> <td>8</td> <td>2</td> <td>14</td> <td>20</td> <td>4</td> <td>18</td> <td>28</td> <td>5</td> <td>22</td> <td>36</td> <td>7</td> </tr> <tr> <td>10/11</td> <td>12</td> <td>2</td> <td>15</td> <td>20</td> <td>3</td> <td>19</td> <td>28</td> <td>3</td> <td>23</td> <td>36</td> <td>5</td> </tr> <tr> <td>12</td> <td>16</td> <td>2</td> <td>16</td> <td>24</td> <td>4</td> <td>20</td> <td>32</td> <td>6</td> <td>24</td> <td>36</td> <td>7</td> </tr> <tr> <td>13</td> <td>16</td> <td>2</td> <td>17</td> <td>24</td> <td>3</td> <td>21</td> <td>32</td> <td>5</td> <td>25</td> <td>40</td> <td>5</td> </tr> </tbody> </table> | Torque | | | Torque | | | Torque | | | Torque | | | Shell Size | Max. | Min. | Shell Size | Max. | Min. | Shell Size | Max. | Min. | Shell Size | Max. | Min. | 8/9 | 8 | 2 | 14 | 20 | 4 | 18 | 28 | 5 | 22 | 36 | 7 | 10/11 | 12 | 2 | 15 | 20 | 3 | 19 | 28 | 3 | 23 | 36 | 5 | 12 | 16 | 2 | 16 | 24 | 4 | 20 | 32 | 6 | 24 | 36 | 7 | 13 | 16 | 2 | 17 | 24 | 3 | 21 | 32 | 5 | 25 | 40 | 5 |
| Torque | | | Torque | | | Torque | | | Torque | | | | | | | | | | | | | | | | | | | | | | | | | | | | | | | | | | | | | | | | | | | | | | | | | | | | | | | | | | | | | | | | | |
| Shell Size | Max. | Min. | Shell Size | Max. | Min. | Shell Size | Max. | Min. | Shell Size | Max. | Min. | | | | | | | | | | | | | | | | | | | | | | | | | | | | | | | | | | | | | | | | | | | | | | | | | | | | | | | | | | | | | | | |
| 8/9 | 8 | 2 | 14 | 20 | 4 | 18 | 28 | 5 | 22 | 36 | 7 | | | | | | | | | | | | | | | | | | | | | | | | | | | | | | | | | | | | | | | | | | | | | | | | | | | | | | | | | | | | | | | |
| 10/11 | 12 | 2 | 15 | 20 | 3 | 19 | 28 | 3 | 23 | 36 | 5 | | | | | | | | | | | | | | | | | | | | | | | | | | | | | | | | | | | | | | | | | | | | | | | | | | | | | | | | | | | | | | | |
| 12 | 16 | 2 | 16 | 24 | 4 | 20 | 32 | 6 | 24 | 36 | 7 | | | | | | | | | | | | | | | | | | | | | | | | | | | | | | | | | | | | | | | | | | | | | | | | | | | | | | | | | | | | | | | |
| 13 | 16 | 2 | 17 | 24 | 3 | 21 | 32 | 5 | 25 | 40 | 5 | | | | | | | | | | | | | | | | | | | | | | | | | | | | | | | | | | | | | | | | | | | | | | | | | | | | | | | | | | | | | | | |
| Durability | 4 5 7 | Connector halves shall be mated and unmated 250 times for Series II with ground fingers and 500 times for Series I and III at a rate not exceeding 300 cycles per hour. The test may be performed by hand or by mechanical means, but the coupling ring shall be operated as in normal service. Failure to complete this test because of mechanical malfunction shall be cause for rejection. | | | | | | | | | | | | | | | | | | | | | | | | | | | | | | | | | | | | | | | | | | | | | | | | | | | | | | | | | | | | | | | | | | | | | | | | |
| Insulation Resistance | 4 5 9 | An insulation resistance test shall be performed on unmated connectors in accordance with MIL-STD-202, Method 302, Test condition B. Measurement shall be made between three pairs of adjacent contacts and the shell. Failure to meet the minimum requirement of 50,000 megohms for Classes E, P, F, R, and T shall be cause for rejection. | | | | | | | | | | | | | | | | | | | | | | | | | | | | | | | | | | | | | | | | | | | | | | | | | | | | | | | | | | | | | | | | | | | | | | | | |
| Vibration | 4 5 22 | Wired, mated connectors shall be subjected to the vibration test of MIL-STD-202, Method 214, Test Condition II, except that the duration shall be one hour in each plane. Receptacles shall be mounted on the vibration fixture by normal means. All contacts shall be wired in a series circuit and 100-500 milliamperes of current shall be allowed to flow through the series circuit during vibration. Suitable means shall be employed to monitor the current flow and to indicate any discontinuity of more than 1 microsecond. The wire bundle shall be clamped to the nonvibrating points at least 8 inches from the rear of the connector. Current discontinuity of 1 microsecond or more, disengagement of the mated connectors, evidence of cracking, breaking, or loosening of parts shall be cause for rejection. | | | | | | | | | | | | | | | | | | | | | | | | | | | | | | | | | | | | | | | | | | | | | | | | | | | | | | | | | | | | | | | | | | | | | | | | |
| Shock | 4 5 23 | Wired mated connectors shall be subjected to one shock in each direction in each of three mutually perpendicular axes. The pulse shall be approximate half sine wave of 300g ± 15% magnitude with a duration of 3 ± 1 milliseconds. Receptacles shall be mounted on a shock fixture by normal means. All contacts shall be wired in a series circuit and 100-150 ma. of current shall flow through the series circuit during shock. Suitable means shall be employed to monitor the current flow and to indicate any discontinuity of more than 1 microsecond. The wire bundle shall be clamped to fixed points at least 8 inches from the rear of the connector. Current discontinuity of 1 microsecond or more, disengagement of the mated connectors, evidence of cracking, breaking, or loosening of parts shall be cause for rejection. | | | | | | | | | | | | | | | | | | | | | | | | | | | | | | | | | | | | | | | | | | | | | | | | | | | | | | | | | | | | | | | | | | | | | | | | |
| Thermal Shock | 4 5 4 | Unmated receptacles shall be subjected to 10 cycles of thermal shock in the following manner: Step a The receptacle shall be suspended for 10 + 1 - 0 minutes in the center of a cold water bath with a volume of approximately one cubic foot. No dimension of the bath shall be less than 10 inches. The water temperature shall not exceed 4°C (39.20°F) Step b The receptacle shall be suspended for 10 1 - 0 minutes in the center of a hot water bath with a volume of approximately one cubic foot. No dimension of the bath shall be less than 10 inches. The water temperature shall be not less than 94°C (201°F). The time of transfer from one bath to the other shall not exceed 5 seconds. At the end of the tenth cycle, the receptacle shall have the excess moisture shaken off and shall then be dried in a forced air oven at 66±5°C for 15 ± 1 minutes. Any evidence of damage resulting from this test shall be cause for rejection. | | | | | | | | | | | | | | | | | | | | | | | | | | | | | | | | | | | | | | | | | | | | | | | | | | | | | | | | | | | | | | | | | | | | | | | | |
| Altitude Immersion | 4 5 8 | Mated connectors shall be placed in a container of water at approximately 20°C and placed in an altitude chamber. All wire ends shall be located within the chamber and exposed to the chamber atmosphere, but not submerged. The exposed wire ends shall not be sealed. A quantity of salt, 5 percent by weight, shall be added to make the water conductive. The chamber pressure shall then be reduced to approximately one inch of mercury and maintained for thirty minutes. The chamber pressure shall then be slowly returned to atmospheric. This shall be considered one cycle. Two additional cycles shall be performed. At the end of the last cycle, while the mated connectors are still submerged, the Insulation Resistance Test (room temperature), and the High Potential Test (sea level voltages) shall be performed upon the same circuits. Failure to meet an insulation resistance minimum of 2,000 megohms or any evidence of dielectric breakdown or -flashover shall be cause for rejection. | | | | | | | | | | | | | | | | | | | | | | | | | | | | | | | | | | | | | | | | | | | | | | | | | | | | | | | | | | | | | | | | | | | | | | | | |
| Solvent Immersion | 4 5 29 | Unmated connectors shall be immersed fully in the applicable fluid specified below for 20 hours. After removal from the fluid, each connector shall remain for one hour in free air at room temperature. a.) Jet fuel JP-4 to MIL-J-5624 b.) Aircraft lubricating oil to MIL-L-9236 | | | | | | | | | | | | | | | | | | | | | | | | | | | | | | | | | | | | | | | | | | | | | | | | | | | | | | | | | | | | | | | | | | | | | | | | |
| Corrosion | 4 5 12 | Unmated connectors and individual contact samples shall be subjected to the soft spray of MIL-STD-202, Method 101, Test Condition 8 (tin plated, Class Y receptacles-24 hours). Immediately after exposure, the surfaces of the specimens shall be thoroughly washed in tap water and dried in a circulatory oven at a temperature of 38 ± 3°C (100°F) for a period of approximately 12 hours. Any exposure of basis metal as a result of this test, shall be cause for rejection. | | | | | | | | | | | | | | | | | | | | | | | | | | | | | | | | | | | | | | | | | | | | | | | | | | | | | | | | | | | | | | | | | | | | | | | | |
| Dynamic Salt Spray | 4 5 12 2 | (Series I and 11, finish B; Series III, class W). The wired assembled plugs and receptacles shall be mated and unmated 50 cycles at a rate of 300 cycles per hour maximum. The mating and unmating shall be accomplished so that the plug and receptacle are completely separated during each cycle. The connectors shall then be subjected to the salt spray test in accordance with method 1001 of MIL-STD- 1344. The connectors shall be tested for 452 hours mated followed by 48 hours unmated. After the salt spray exposure the remaining number of durability cycles specified in 4.7.7 shall be completed. | | | | | | | | | | | | | | | | | | | | | | | | | | | | | | | | | | | | | | | | | | | | | | | | | | | | | | | | | | | | | | | | | | | | | | | | |
| Temperature Durability | 4 5 33 | Wired rated connectors shall be subjected to the indicated ambient temperature for a period of 1,000 hours <table border="1" style="margin-left: auto; margin-right: auto;"> <tbody> <tr> <td>Series I and II (finish A)</td> <td>150^{+3°}_{-0°C} (302° F)</td> <td>Series I and II (finish B)</td> <td>175^{+3°}_{-0°C} (347° F)</td> </tr> <tr> <td>Series III (class W)</td> <td>175^{+3°}_{-0°C} (347° F)</td> <td>All other finishes</td> <td>200^{+3°}_{-0°C} (392° F)</td> </tr> </tbody> </table> | Series I and II (finish A) | 150 ^{+3°} _{-0°C} (302° F) | Series I and II (finish B) | 175 ^{+3°} _{-0°C} (347° F) | Series III (class W) | 175 ^{+3°} _{-0°C} (347° F) | All other finishes | 200 ^{+3°} _{-0°C} (392° F) | | | | | | | | | | | | | | | | | | | | | | | | | | | | | | | | | | | | | | | | | | | | | | | | | | | | | | | | | | | | | | | | |
| Series I and II (finish A) | 150 ^{+3°} _{-0°C} (302° F) | Series I and II (finish B) | 175 ^{+3°} _{-0°C} (347° F) | | | | | | | | | | | | | | | | | | | | | | | | | | | | | | | | | | | | | | | | | | | | | | | | | | | | | | | | | | | | | | | | | | | | | | | |
| Series III (class W) | 175 ^{+3°} _{-0°C} (347° F) | All other finishes | 200 ^{+3°} _{-0°C} (392° F) | | | | | | | | | | | | | | | | | | | | | | | | | | | | | | | | | | | | | | | | | | | | | | | | | | | | | | | | | | | | | | | | | | | | | | | |

* For reference only



Dimensions shown in mm
 Specifications and dimensions subject to change

www.ittcannon.com

Product Safety Information

THIS NOTE MUST BE READ IN CONJUNCTION WITH THE PRODUCT DATA SHEET/CATALOG. FAILURE TO OBSERVE THE ADVICE IN THIS INFORMATION SHEET AND THE OPERATING CONDITIONS SPECIFIED IN THE PRODUCT DATA SHEET/ CATALOG COULD RESULT IN HAZARDOUS SITUATIONS.

1. MATERIAL CONTENT AND PHYSICAL FORM

Electrical connectors do not usually contain hazardous materials. They contain conducting and non-conducting materials and can be divided into two groups.

- a) Printed circuit types and low cost audio types which employ all plastic insulators and casings.
- b) Rugged, Fire Barrier and High Reliability types with metal casings and either natural rubber, synthetic rubber, plastic or glass insulating materials. Contact materials vary with type of connector and also application and are usually manufactured from either: Copper, copper alloys, nickel, alumel, chromel or steel. In special applications, other alloys may be specified.

2. FIRE CHARACTERISTICS AND ELECTRIC SHOCK HAZARD

There is no fire hazard when the connector is correctly wired and used within the specified parameters. Incorrect wiring or assembly of the connector or careless use of metal tools or conductive fluids, or transit damage to any of the component parts may cause electric shock or burns. Live circuits must not be broken by separating mated connectors as this may cause arcing, ionization and burning. Heat dissipation is greater at maximum resistance in a circuit. Hot spots may occur when resistance is raised locally by damage, e.g. cracked or deformed contacts, broken strands of wire. Local overheating may also result from the use of the incorrect application tools or from poor quality soldering or slack screw terminals. Overheating may occur if the ratings in the product Data Sheet/Catalog are exceeded and can cause breakdown of insulation and hence electric shock. If heating is allowed to continue it intensifies by further increasing the local resistance through loss of temper of spring contacts, formation of oxide film on contacts and wires and leakage currents through carbonization of insulation and tracking paths. Fire can then result in the presence of combustible materials and this may release noxious fumes. Overheating may not be visually

apparent. Burns may result from touching overheated components.

3. HANDLING

Care must be taken to avoid damage to any component parts of electrical connectors during installation and use. Although there are normally no sharp edges, care must be taken when handling certain components to avoid injury to fingers. Electrical connectors may be damaged in transit to the customers, and damage may result in creation of hazards. Products should therefore be examined prior to installation/use and rejected if found to be damaged.

4. DISPOSAL

Incineration of certain materials may release noxious or even toxic fumes.

5. APPLICATION

Connectors with exposed contacts should not be selected for use on the current supply side of an electrical circuit, because an electric shock could result from touching exposed contacts on an unmated connector. Voltages in excess of 30 V ac or 42.5 V dc are potentially hazardous and care should be taken to ensure that such voltages cannot be transmitted in any way to exposed metal parts of the connector body. The connector and wiring should be checked, before making live, to have no damage to metal parts or insulators, no solder blobs, loose strands, conducting lubricants, swarf, or any other undesired conducting particles. Circuit resistance and continuity check should be made to make certain that there are no high resistance joints or spurious conducting paths. Always use the correct application tools as specified in the Data Sheet/Catalog. Do not permit untrained personnel to wire, assemble or tamper with connectors. For operation voltage please see appropriate national regulations.

IMPORTANT GENERAL INFORMATION

(i) Air and creepage paths/Operating voltage. The admissible operating voltages depend on the individual applications and the valid national and other applicable safety regulations.

For this reason the air and creepage path data are only reference values. Observe reduction of air and creepage paths due to PC board and/or harnessing.

(ii) Temperature

All information given are temperature limits. The operation temperature depends on the individual application.

(iii) Other important information

Cannon continuously endeavors to improve their products. Therefore, Cannon products may deviate from the description, technical data and shape as shown in this catalog and data sheets.

“Engineered for life” is a registered trademark of ITT Industries, © 2005. All other trademarks or registered trademarks are property of their respective owners. All data subject to change without notice.

Product Warranty

ITT Industries, Cannon manufactures the highest quality products available in the marketplace; however these products are intended to be used in accordance with the specifications in this publication. Any use or application that deviates from the stated operating specifications is not recommended and may be unsafe. No information and data contained in this publication shall be construed to create any liability on the part of Cannon. Any new issue of this publication shall automatically invalidate and supersede any and all previous issues. A limited warranty applies to Cannon products. Except for obligations assumed by Cannon under this warranty, Cannon shall not be liable for any loss, damage, cost of repairs, incidental or consequential damages of any kind, whether or not based on express or implied warranty, contract, negligence or strict liability arising in connection with the design, manufacture, sale, use or repair of the products. Product availability, prices and delivery dates are exclusively subject to our respective order confirmation form; the same applies to orders based on development samples delivered. This publication is not to be construed as an offer. It is intended merely as an invitation to make an offer. By this publication, Cannon does not assume responsibility or any liability for any patent infringements or other rights of third parties which may result from its use. Reprinting this publication is generally permitted, indicating the source. However, Cannon's prior consent must be obtained in all cases.



Connector Product Locations

With manufacturing facilities, sales representatives and distributors located worldwide, please visit our website at www.ittcannon.com for a complete listing and to find the office nearest you.

GERMANY

Cannonstrasse 1
Weinstadt, 71384
phone: 49.7151.699.0
fax: 49.7151.699.217

HONG KONG

Unit 901 & 912, West Tower
Shun Tak Center
168-200 Connaught Road
Central
phone: 852.2732.2720
fax: 852.2732.2919

ITALY

Via Pietro Panzeri 10
Milano, 20123
phone: 39.2.58180.1
fax: 39.2.8372036

UK

Jays Close, Viables Estate
Basingstoke, RG22 4BA
phone: 44.1256.311200
fax: 44.1256.323356

USA

666 East Dyer Road
Santa Ana, CA 92705
toll free: 1.800.854.3028
phone: 1.714.557.4700
fax: 1.714.628.2142

