

2.54mm (1.00") Pitch

PCB and Wire Connectors

C

SL™ Modular Interconnect System

Terminals.....	C-6 to C-7
Crimp Housings	C-7 to C-12
Insulation Displacement Connector Assemblies.....	C-13 to C-19
Wire-to-Wire Connectors.....	C-20 to C-22
Interim Clips.....	C-22 to C-23
Wire-to-Board Headers	
Shrouded.....	C-23 to C-27

C-Grid® Modular Interconnect System

Headers	
Breakaway, Dual Row.....	C-27 to C-30
Shrouded, Dual Row.....	C-30 to C-37
PCB Connectors and Receptacles	C-38 to C-41
Shunt/Jumper	C-42
Micro Shunt.....	C-42

C-Grid III™ Modular Interconnect System

Terminal.....	C-44
Crimp Housings	C-44
Headers	
Single Row.....	C-45
Dual Row.....	C-46 to C-47
Shrouded.....	C-48 to C-49
PCB Connectors	C-50

KK® Modular Interconnect System

Terminal.....	C-52 to C-53
Crimp Housings	C-54
IDT Connectors.....	C-55 to C-56
Headers	
Breakaway.....	C-57 to C-59
Solid.....	C-59 to C-62
PCB Connectors	C-62 to C-64

Custom Headers

Single Row	C-65
Dual Row	C-66
Pogo Pin Connector.....	C-67

C-Grid® and SL™ High Density Connectors Introduction

2.54mm (.100") Pitch PCB and Wire Connectors

Molex presents its 2.54mm (.100") pitch grid interconnection products. . . C-Grid, the dual row, board-to-board system and SL™, the modular, single row wire-to-board and wire-to-wire system.

The proven design of both the C-Grid and SL systems features similar material and electrical specifications. Both utilize 0.64mm (.025") square pins and selective Gold or Tin plating.

C-Grid, based on a .100" grid, is designed for dense electronic packaging. The system includes: vertical and right angle headers in breakaway, shrouded and dual-body styles; vertical and right angle receptacles; headers and receptacles for SMT applications; and a 2-circuit shunt completes the C-Grid product line.

SL is designed for high density signal applications. The system includes: low profile latching vertical and right angle headers; 5 stackable, low profile housings for male or female crimp terminals; pre-assembled, single piece pin and receptacle connector assemblies for IDT termination of discrete wire or ribbon cable and piercing crimp termination

of FFC/FPC; single and dual row latching interim clips for stacking of subassemblies to form larger connectors; panel mounts for modular wire-to-wire remote interconnections; and SL offers design flexibility and automated harness-making capabilities when combined with our tooling.

These 4 low profile, stackable housings form the basis of the single row system. Each housing accommodates either male or female terminals, IDT or crimp.

The "A" version is infinitely stackable on the X-Y matrix.

The "C" version has ribs on the front end that polarize and also prevent the housing from twisting off the mating pins during mating/disconnect.

The "D" version has back ribs that polarize, guide and maintain the connector in position in an interim clip or panel mount. It is used with both male and female terminals.

The "G" version has front ribs as well as a positive locking latch and anti-entanglement ribs to prevent wires from catching under the latch during harness-making and storage.

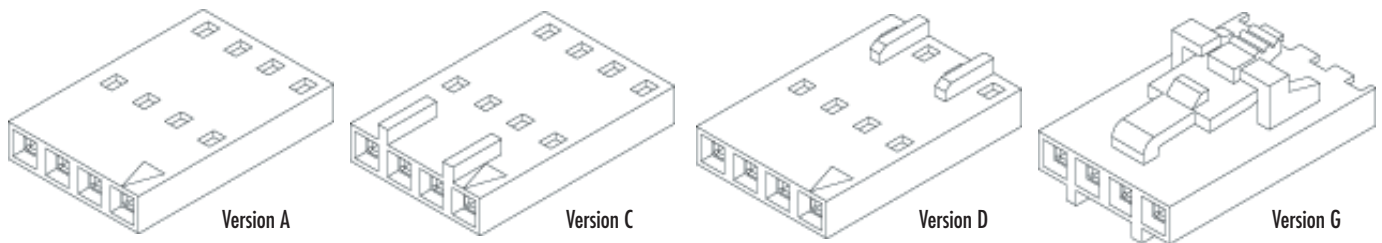

SL™ boasts pre-assembled, single piece construction of its insulation displacement-type connector assemblies. These can terminate both discrete wire or ribbon cable.

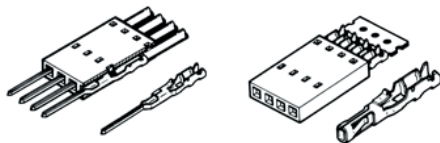

Preloaded assemblies are loaded into plastic tubes that protect the product during shipping and also allow the connector to be integrated into highly automated harness production.

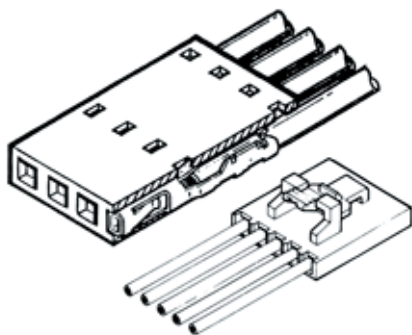

After termination the housings are locked over the terminal and the carrier strip is broken off. This automated process, with built-in diagnostic systems, assures quality products.

Shown: Wire-to-wire connection using male connectors in "D" version housings. The ribs interface to slots on the underside of the panel mount. Once loaded, the panel mount is fitted into place in the panel. Completing the connection, the female connector, "G" version, is guided through the other end of the panel mount via polarization slots. Positive latch ensures a tight lock.

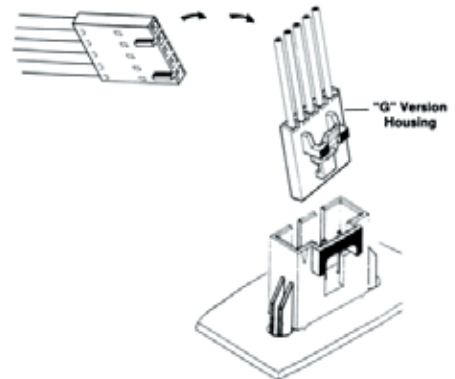
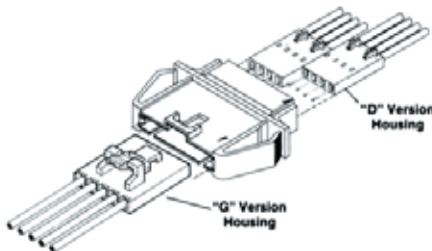

Shown: Wire-to-board connection using a shrouded header with PC board locks and a "G" version female connector. The polarizing ribs on the connector prevent it from breaking or bending the pins on the header during mating and disconnect. Note the positive latching feature.

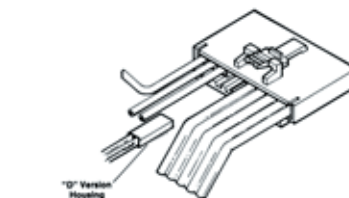
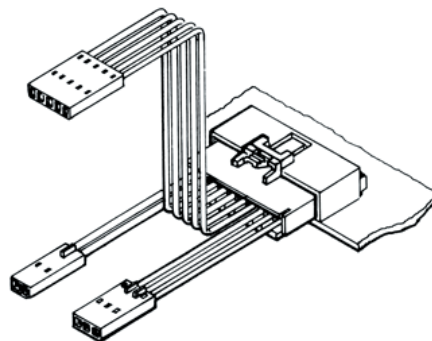

Shown: Gang loading of subassemblies in an interim clipmodule. The slots in the clip guide the "D" version housing during loading and also prevent the housing from drifting within the clip.

SL™ Modular Interconnection System

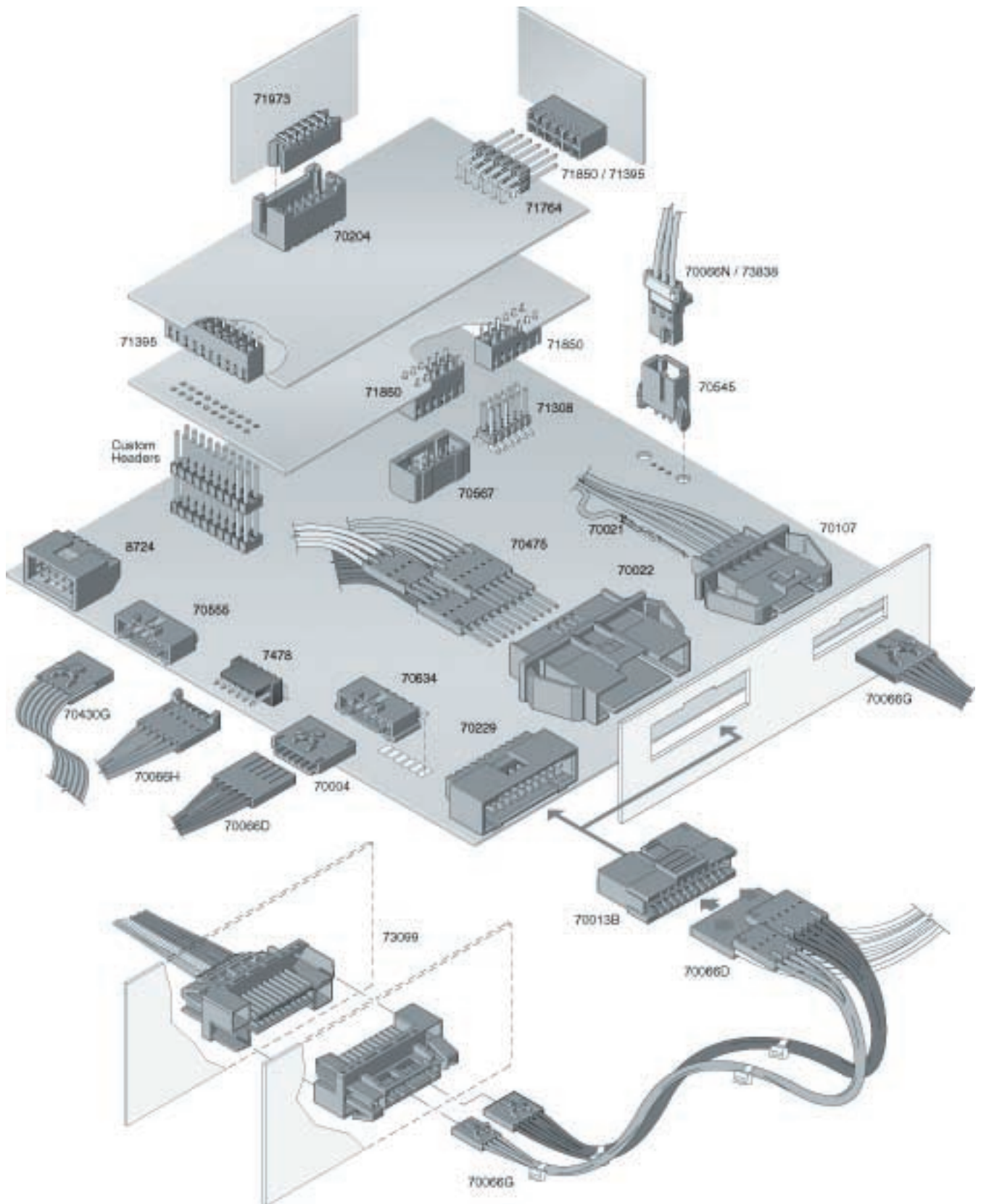

2.54mm (.100") Pitch PCB and Wire Connectors

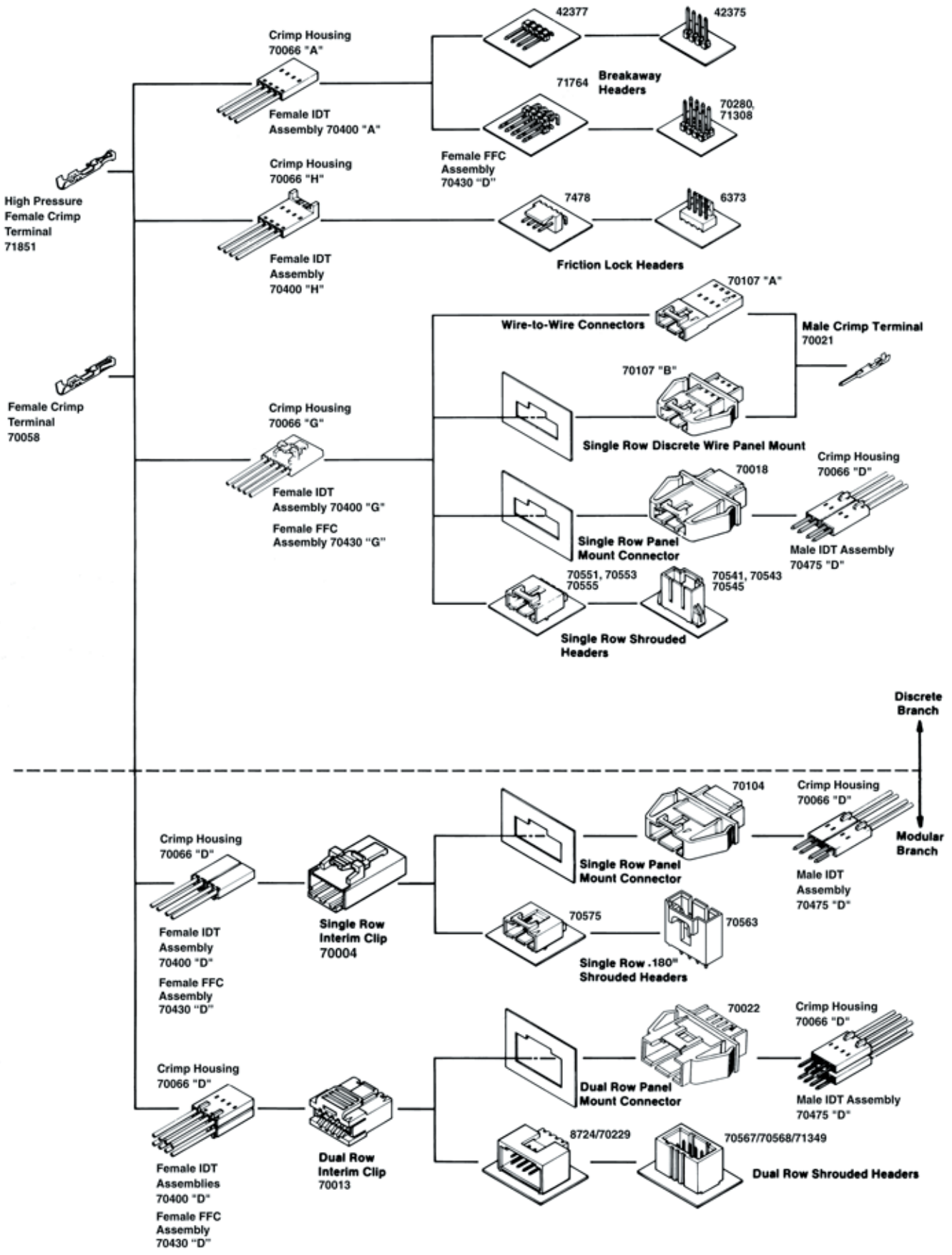

SL™ Modular Interconnection System

2.54mm (.100") Pitch PCB and Wire Connectors







2.54mm (.100") Pitch C-Grid®/SL™ Modular Interconnect System



- Modular Interconnect System Wire-to-wire, wire-to-board and board-to-board applications
- Three Termination Methods: Crimp, IDT, FFC Cable Piercing
- Positive Latching System
- Through Hole and SMT configurations

	Description	Specifications	Materials	Circuits/Wire Gauge	Options	Series No.
	Female Crimp terminal	3.0A, 250V -40 to +105°C	Copper Alloy	22-30 AWG	Bag or Reel	70058 (Standard)
						71851 (High Force)
	Male Crimp Terminal					70021







Housings

	Crimp Housing (to be used with female terminals)	3.0A, 250V -40 to +105°C	Housing: Black polyester, UL 94V-0	2-25	Single Row	70066
				4-54	Dual Row	70450
	Crimp Housing (to be used with Male terminals)	3.0A, 250V -40 to +105°C	Housing: Black polyester, UL 94V-0	2-25	Single Row	70107
	Modular Branch	3.0A, 250V -40 to +105°C	Housing: Black polyester, UL 94V-0	2-25	Single Row	70018, 70104
				6-50	Dual Row	70022
	Interim Clip	3.0A, 250V -40 to +105°C	Housing: Black polyester, UL 94V-0	4-25	Single Row	70004
				6-50	Dual Row	70013



Assemblies

	Insulation Displacement Single Row Assembly	1.2A - 28 AWG 1.8A - 26 AWG 3.0A - 22 AWG 3.0A - 24 AWG -40 to + 105°C	Housing: Black polyester, UL 94V-0	2-25	Female	70400
					Male	70475
	FFC/FPC Single Row Assembly	2.0A, 250V -40 to +105°C	Housing: Black polyester, UL 94V-0	2-25	Female	70430
					Male	70431

Headers*

	Vertical Shrouded Header	3.0A, 250V -40 to +105°C	Housing: Black glass-filled PCT, UL 94V-0	2-25	Single Row	70543, 70541, 70545, 74190, 70563, 74099
						70553, 70551, 70555, 70634, 70575
	Right Angle Shrouded Header	3.0A, 250V -40 to +105°C	Housing: Polyester or high temperature thermal plastic, UL 94V-0	4-100	Dual Row	70280, 71308
						71764, 70216
	Vertical Unshrouded Breakaway Header	3.0A, 250V -40 to +105°C	Housing: Polyester or high temperature thermal plastic, UL 94V-0	6-72	Dual Row	70567, 70568, 71349, 70204
						8724, 70229
	Right Angle Unshrouded Breakaway Header	3.0A, 250V -40 to +105°C	Housing: Polyester or high temperature thermal plastic, UL 94V-0	6-72	Dual Row	70567, 70568, 71349, 70204
						8724, 70229
	Vertical Shrouded Header	3.0A, 250V -40 to +105°C	Housing: Polyester or high temperature thermal plastic, UL 94V-0	6-72	Dual Row	70567, 70568, 71349, 70204
						8724, 70229
	Right Angle Shrouded Header	3.0A, 250V -40 to +105°C	Housing: Polyester or high temperature thermal plastic, UL 94V-0	6-72	Dual Row	70567, 70568, 71349, 70204
						8724, 70229

Receptacles

	Vertical PCB Receptacle	2.5A, 250V -40 to +105°C	Housing: High temperature thermal plastic, UL 94V-0	4-80	Dual Row	71850, 71395
						71979, 71973
	Right Angle PCB Receptacle	2.5A, 250V -40 to +105°C	Housing: High temperature thermal plastic, UL 94V-0	8-72	Dual Row	71850, 71395
						71979, 71973

C

2.54mm (.100") Pitch PCB and Wire Connectors

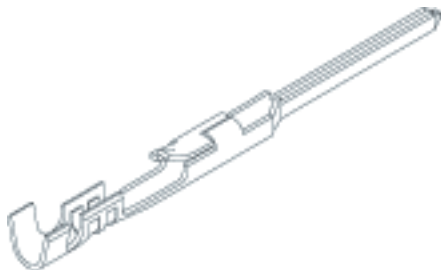
2.54mm (.100") Pitch**SL™
Terminal****70021
Male, Crimp****Features and Benefits**

- Dual tab strain relief
- Locking tang secures terminal in housing

Reference Information

Product Specification: PS-70021
 Packaging: Reel or bag
 Mates With: 70058 and 71851 female crimp terminals,
 and 70400 and 70430 connector assemblies
 Use With: 70066D and 70107 housings
 Designed In: Inches

Electrical

Voltage: 250V
 Current: 3.0A
 Contact Resistance: 15 milliohms max.
 Insulation Resistance: 10,000 Megohms min.

Mechanical

Wire Pull-Out Force: 17.79N (4.0 lb) min.
 Durability: Tin—25 cycles; Gold—50 cycles

Physical

Contact: Copper Alloy
 Plating: See Table
 Operating Temperature: -40 to +105°C
 Wire Gauge: 22 to 24 and 24 to 30 AWG

Not For Use With C-Grid III™ Components

Reel				
Order No.	Plating	Wire Range (AWG) Stranded	Insulation Maximum Outside Diameter	Lead-free
16-02-0116	1	22-24	1.63 (.064)	Yes
16-02-0078		24-30	1.52 (.060)	
16-02-0081	2	22-24	1.63 (.064)	
16-02-0077		24-30	1.52 (.060)	
16-02-0107	3	22-24	1.63 (.064)	
16-02-0105		24-30	1.52 (.060)	

Plating No. 1: 30µm min. Gold in select area over 50µm min. Nickel overall with 75µm Tin in select area
 Plating No. 2: 15µm min. Gold in select area over 50µm min. Nickel overall with 75µm min. Tin in select area
 Plating No. 3: 150µm Tin over 50µm Nickel overall
 Each reel contains 20,000 terminals

Bag				
Order No.	Plating	Wire Range (AWG) Stranded	Insulation Maximum Outside Diameter	Lead-free
16-02-0117	1	22-24	1.63 (.064)	Yes
16-02-0110		24-30	1.52 (.060)	
16-02-0115	2	22-24	1.63 (.064)	
16-02-0109		24-30	1.52 (.060)	
16-02-0114	3	22-24	1.63 (.064)	
16-02-0108		24-30	1.52 (.060)	

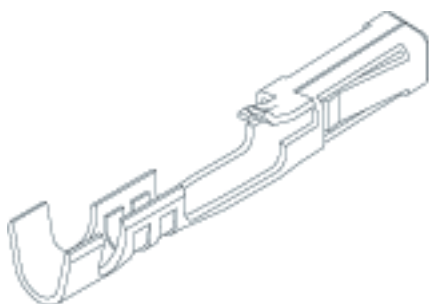
2.54mm (.100") Pitch**SL™
Terminal****70058
Female Box, Crimp****Features and Benefits**

- Dual beam, fully-enclosed box contact
- Dual tab strain relief
- Locking tang secures terminal in housing

Reference Information

Product Specification: PS-70058
 Packaging: Reel or bag
 Mates With: 70021 male crimp terminals and
 0.64mm (.025") square pins
 Use With: All 70066 and 70450 housings
 Designed In: Inches

Electrical

Voltage 250V
 Current: 3.0A
 Contact Resistance: 15 milliohms max.
 Insulation Resistance: 10,000 Megohms min.

Mechanical

Contact Retention to Housing: 17.79N (4.0 lb) min.
 Wire Pull-Out Force: 17.79N (4.0 lb) min.
 Mating Force: 2.22N (.50 lb) max.
 Unmating Force: 0.28N (.06 lb) min.
 Normal Force: 0.98N (.22 lb) min.
 Durability: Tin—25 cycles; Gold—50 cycles

Physical

Contact: Copper Alloy
 Plating: See Table
 Operating Temperature: -40 to +105°C
 Wire Gauge: 22 to 24 and 24 to 30 AWG

Not For Use With C-Grid III™ Components

Reel				
Order No.	Plating	Wire Range (AWG) Stranded	Insulation Maximum Outside Diameter	Lead-free
16-02-0088	1	22-24	1.63 (.064)	Yes
16-02-0083		24-30	1.52 (.060)	
16-02-0087	2	22-24	1.63 (.064)	
16-02-0082		24-30	1.52 (.060)	
16-02-0086	3	22-24	1.63 (.064)	
16-02-0069		24-30	1.52 (.060)	

Plating No. 1: 30µm min. Gold in select area over 50µm min. Nickel overall with 75µm Tin in select area
 Plating No. 2: 15µm min. Gold in select area over 50µm min. Nickel overall with 75µm min. Tin in select area
 Plating No. 3: 150µm Tin over 50µm Nickel overall
 Each reel contains 20,000 terminals

Bag				
Order No.	Plating	Wire Range (AWG) Stranded	Insulation Maximum Outside Diameter	Lead-free
16-02-0104	1	22-24	1.63 (.064)	Yes
16-02-0098		24-30	1.52 (.060)	
16-02-0103	2	22-24	1.63 (.064)	
16-02-0097		24-30	1.52 (.060)	
16-02-0102	3	22-24	1.63 (.064)	
16-02-0096		24-30	1.52 (.060)	

2.54mm (.100") Pitch SL™ Terminal

71851 Female, High Force Crimp

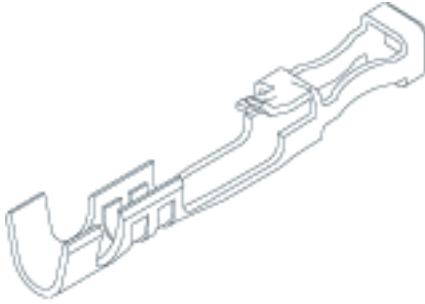

Features and Benefits

- Dual beam, fully-enclosed box contact
- Higher mating force than standard crimp terminal
- For use with low current/high vibration applications in small circuit sizes
- Dual tab strain relief
- Locking tang secures terminal in housing

Reference Information

Product Specification: PS-71851

Packaging: Reel or bag

Mates With: 70021 male crimp terminals,
70431 and 70475 male connector assemblies
and 0.64mm (.025") square pins

Use With: 70066 and 70450 housings

Designed In: Inches

Electrical

Voltage: 250V

Current: 3.0A

Contact Resistance: 15 milliohms max.

Insulation Resistance: 10,000 Megohms min.

Mechanical

Contact Retention to Housing: 17.79N (4.0 lb) min.

Wire Pull-Out Force: 17.79N (4.0 lb) min.

Mating Force: Tin—12.14N (2.73 lb) max.

Gold—5.07N (1.14 lb)

Unmating Force: Tin—3.60N (.81 lb) min.

Gold—2.36N (.53 lb)

Durability: Tin—25 cycles; Gold—50 cycles

Physical

Contact: Copper Alloy

Plating: See Table

Operating Temperature: -40 to +105°C

Wire Gauge: 22 to 24 and 24 to 30 AWG

Not For Use With C-Grid III™ Components

Reel				
Order No.	Plating	Wire Range (AWG) Stranded	Insulation Maximum Outside Diameter	Lead-free
16-02-1111	1	22-24	1.63 (.064)	Yes
16-02-1113		24-30	1.52 (.060)	
16-02-1124		22-24	1.63 (.064)	
16-02-0119	2	24-30	1.52 (.060)	
16-02-1110		22-24	1.63 (.064)	
16-02-1112	3	24-30	1.52 (.060)	

Bag				
Order No.	Plating	Wire Range (AWG) Stranded	Insulation Maximum Outside Diameter	Lead-free
16-02-1115	1	22-24	1.63 (.064)	Yes
16-02-1117		24-30	1.52 (.060)	
16-02-1125		22-24	1.63 (.064)	
16-02-1109	2	24-30	1.52 (.060)	
16-02-1114		22-24	1.63 (.064)	
16-02-1116	3	24-30	1.52 (.060)	

Plating No. 1: 30µm min. Gold in select area over 50µm min. Nickel overall with 75µm Tin

Plating No. 2: 15µm min. Gold in select area over 50µm min. Nickel overall with 75µm min. Tin in select area

Plating No. 3: 150µm Tin over 50µm Nickel overall

Each reel contains 20,000 terminals

2.54mm (.100") Pitch SL™ Crimp Housing

70066 Single Row Version A, Nonpolarized

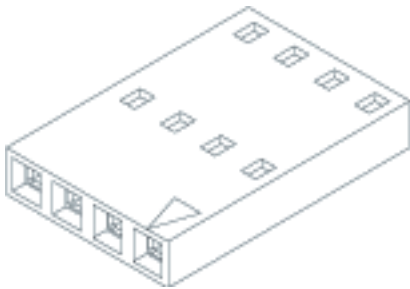

Features and Benefits

- Sizes 2 to 25 circuits
- End-to-end and side-to-side stackable for single or dual row connections to a 2.54mm (.100") pitch grid pin field

Reference Information

Product Specification: PS-70400

Packaging: Bag

UL File No.: E29179

CSA File No.: LR19980

Mates With: 2.54mm (.100") pitch, single or dual row
headers (C-Grid®, SL, KK®)

Use With: 70058 and 71851 crimp terminals

Designed In: Inches

Physical

Housing: Black polyester, UL 94V-0

Operating Temperature: -40 to +105°C



Not For Use With C-Grid III™ Components

Circuits	Order No.
2	50-57-9002
3	50-57-9003
4	50-57-9004
5	50-57-9005
6	50-57-9006
7	50-57-9007
8	50-57-9008
9	50-57-9009

Circuits	Order No.
10	50-57-9010
11	50-57-9011
12	50-57-9012
13	50-57-9013
14	50-57-9014
15	50-57-9015
16	50-57-9016
17	50-57-9017

Circuits	Order No.
18	50-57-9018
19	50-57-9019
20	50-57-9020
21	50-57-9021
22	50-57-9022
23	50-57-9023
24	50-57-9024
25	50-57-9025

2.54mm (.100") Pitch SL™ Crimp Housing

70066

Single Row Version C, Front Ribs

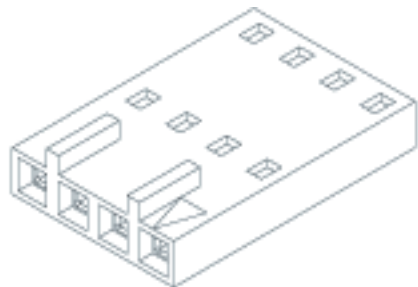

Not For Use With C-Grid III™ Components

Circuits	Order No.
2	50-57-9202
3	50-57-9203
4	50-57-9204
5	50-57-9205
6	50-57-9206
7	50-57-9207
8	50-57-9208
9	50-57-9209

Features and Benefits

- Sizes 2 to 25 circuits
- Front ribs prevent contact damage when unmating the connector from a header; the housing cannot be twisted off pins
- Front ribs provide 180° polarization

Reference Information

Product Specification: PS-70400
 Packaging: Bag
 UL File No.: E29179
 CSA File No.: LR19980
 Mates With: 2.54mm (.100") pitch SL headers
 Use With: 70058 and 71851 crimp terminals
 Designed In: Inches

Physical

Housing: Black polyester, UL 94V-0
 Operating Temperature: -40 to +105°C



2.54mm (.100") Pitch SL™ Crimp Housing

70066

Single Row Version D, Back Ribs

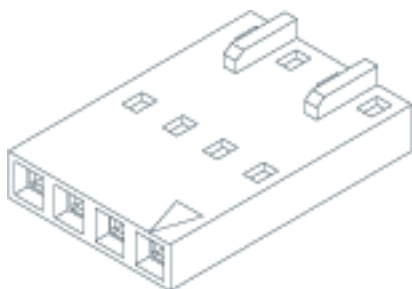

Not For Use With C-Grid III™ Components

Circuits	Order No.
2	50-57-9302
3	50-57-9303
4	50-57-9304
5	50-57-9305
6	50-57-9306
7	50-57-9307
8	50-57-9308
9	50-57-9309

Features and Benefits

- Sizes 2 to 25 circuits
- Designed for use with interim clips and panel mount connectors to form a larger single mating connector
- Back ribs maintain position of connector housing in interim clip and panel mount, and allow for end-to-end or side-to-side stacking in interim clips and panel mount connectors

Reference Information

Product Specification: PS-70400
 Packaging: Bag
 UL File No.: E29179
 CSA File No.: LR19980
 Accessories: Interim clips 70004 and 70013 to form female connector assembly; panel mount connectors 70018, 70022 and 70104 to form a male pin assembly
 Use With: 70021, 70058 and 71851 crimp terminals
 Designed In: Inches

Physical

Housing: Black polyester, UL 94V-0
 Operating Temperature: -40 to +105°C

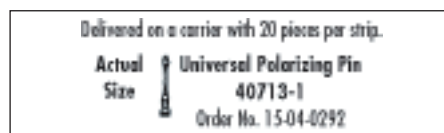

2.54mm (.100") Pitch SL™ Crimp Housing

70066
Single Row
Version G, Positive Latch

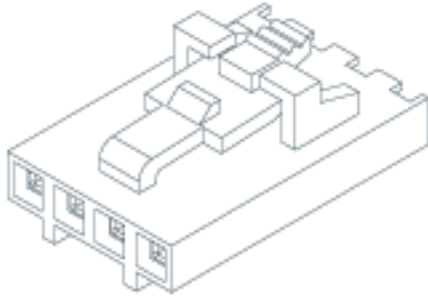

Features and Benefits

- Sizes 2 to 25 circuits
- Positive latch secures housing to locking crown of mating header or panel mount
- Anti-entanglement/overstress ribs prevent discrete wires from catching under latch during harness manufacturing and storage
- Front ribs prevent contact damage when unmating the connector from a header; the housing cannot be twisted off pins

Reference Information

Product Specification: PS-70400
 Packaging: Bag
 UL File No.: E29179
 CSA File No.: LR19980
 Mates With: 70018, 70107A/B, 70541, 70543, 70545, 70551, 70553, 70555, 70634 and 74099
 Use With: 70058 and 71851 crimp terminals
 Designed In: Inches

Physical

Housing: Black polyester, UL 94V-0
 Operating Temperature: -40 to +105°C

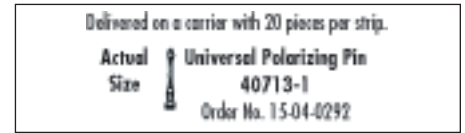

Not For Use With C-Grid III™ Components

Circuits	Order No.
2	50-57-9402
3	50-57-9403
4	50-57-9404
5	50-57-9405
6	50-57-9406
7	50-57-9407
8	50-57-9408
9	50-57-9409

Circuits	Order No.
10	50-57-9410
11	50-57-9411
12	50-57-9412
13	50-57-9413
14	50-57-9414
15	50-57-9415
16	50-57-9416
17	50-57-9417

Circuits	Order No.
18	50-57-9418
19	50-57-9419
20	50-57-9420
21	50-57-9421
22	50-57-9422
23	50-57-9423
24	50-57-9424
25	50-57-9425

2.54mm (.100") Pitch SL™ Crimp Housing

70066
Single Row
Version H

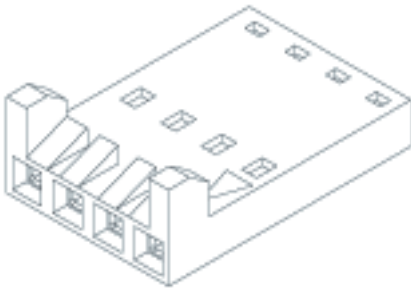

Features and Benefits

- Sizes 2 to 25 circuits
- Stackable end-to-end
- Polarized latching ribs mate with Molex KK® series .100" pitch friction lock headers

Reference Information

Product Specification: PS-70400
 Packaging: Bag
 UL File No.: E29179
 CSA File No.: LR19980
 Mates With: 6373 and 7478
 Use With: 70058 and 71851 crimp terminals
 Designed In: Inches

Physical

Housing: Black polyester, UL 94V-0
 Operating Temperature: -40 to +105°C

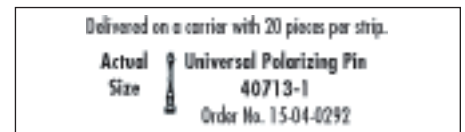

Not For Use With C-Grid III™ Components

Circuits	Order No.
2	50-57-9502
3	50-57-9503
4	50-57-9504
5	50-57-9505
6	50-57-9506
7	50-57-9507
8	50-57-9508
9	50-57-9509

Circuits	Order No.
10	50-57-9510
11	50-57-9511
12	50-57-9512
13	50-57-9513
14	50-57-9514
15	50-57-9515
16	50-57-9516
17	50-57-9517

Circuits	Order No.
18	50-57-9518
19	50-57-9519
20	50-57-9520
21	50-57-9521
22	50-57-9522
23	50-57-9523
24	50-57-9524
25	50-57-9525

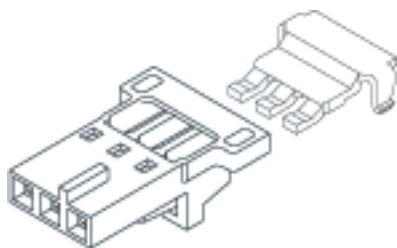
2.54mm (.100") Pitch**SL™
Crimp Housing****70066/73838****Single Row
Version N, TPA
with Positive Latch**

Circuits	70066 Version N TPA Crimp Housing	73838 TPA
	Order No.	Order No.
2	50-57-9702	73838-0002
3	50-57-9703	73838-0003
4	50-57-9704	73838-0004
5	50-57-9705	73838-0005
6	50-57-9706	73838-0006
7	50-57-9707	73838-0007
8	50-57-9708	73838-0008

Features and Benefits

- Optimizes terminal-to-housing retention
- Virtually eliminates terminal backout when TPA is locked into place
- Upon seating TPA, audible click denotes system activation
- White/black color contrast provides easy identification of TPA system
- Positive locking latch secures housing to mating connector
- Anti-entanglement/overstress ribs prevent discrete wires from catching under latch during harness manufacturing and storage

Reference Information

Product Specification: PS-73838, PS-70400

Packaging: Bag

UL File No.: E29179

CSA File No.: LR19980

Mates with: 70018, 70107A/B, 70541, 70543, 70545, 70551, 70553, 70555, 70634 and 74099

Use with: 73838 TPA and 70058 or 71851 crimp terminals

Designed In: Inches

Physical

Housing: Black polyester, UL 94V-0

TPA: White polyester, UL 94V-0

Operating Temperature: -40 to +105°C

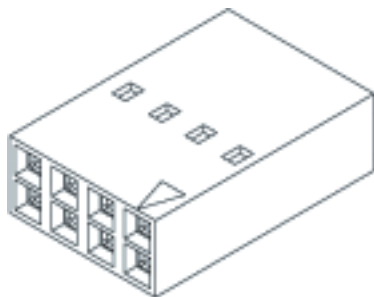
2.54mm (.100") Pitch**SL™
Crimp Housing****70450****Dual Row
Version A, Nonpolarized****Features and Benefits**

- Sizes 4 to 54 circuits
- End-to-end and side-to-side stackable for dual row connections to a 2.54mm (.100") pitch grid pin field

Reference Information

Product Specification: PS-70400

Packaging: Bag

UL File No.: E29179

CSA File No.: LR19980

Mates With: 8724, 70229, 70280, 70287, 70567, 70568,

71308 and 71349 Molex dual row headers

Use With: 70058 and 71851 crimp terminals

Designed In: Inches

Physical

Housing: Black polyester, UL 94V-0

Operating Temperature: -40 to +105°C

Delivered on a carrier with 20 pieces per strip.

Actual Size  Universal Polarizing Pin
40713-1
Order No. 15-04-0292

Not For Use With C-Grid III™ Components

Circuits	Order No.
4	22-55-2041
6	22-55-2061
8	22-55-2081
10	22-55-2101
12	22-55-2121
14	22-55-2141
16	22-55-2161
18	22-55-2181
20	22-55-2201

Circuits	Order No.
22	22-55-2221
24	22-55-2241
26	22-55-2261
28	22-55-2281
30	22-55-2301
32	22-55-2321
34	22-55-2341
36	22-55-2361
38	22-55-2381

Circuits	Order No.
40	22-55-2401
42	22-55-2421
44	22-55-2441
46	22-55-2461
48	22-55-2481
50	22-55-2501
52	22-55-2521
54	22-55-2541

2.54mm (.100") Pitch SL™ Crimp Housing

70450
Dual Row
Version B, Polarized

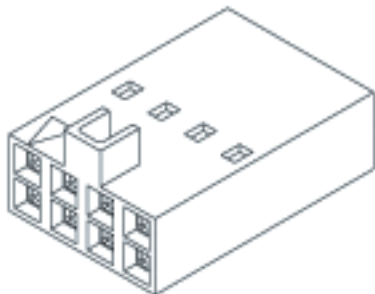

Features and Benefits

- Sizes 4 to 50 circuits
- Polarized to mate with dual row, low profile shrouded headers

Reference Information

Product Specification: PS-70400
Packaging: Bag
UL File No.: E29179
CSA File No.: LR19980
Mates With: 70246, 70247, 87256 and 87257
Use With: 70058 and 71851 crimp terminals
Designed In: Inches

Physical

Housing: Black polyester, UL 94V-0
Operating Temperature: -40 to +105°C



Not For Use With C-Grid III™ Components

Circuits	Order No.
4	22-55-2042
6	22-55-2062
8	22-55-2082
10	22-55-2102
12	22-55-2122
14	22-55-2142
16	22-55-2162
18	22-55-2182

Circuits	Order No.
20	22-55-2202
22	22-55-2222
24	22-55-2242
26	22-55-2262
28	22-55-2282
30	22-55-2302
32	22-55-2322
34	22-55-2342

Circuits	Order No.
36	22-55-2362
38	22-55-2382
40	22-55-2402
42	22-55-2422
44	22-55-2442
46	22-55-2462
48	22-55-2482
50	22-55-2502

2.54mm (.100") Pitch SL™ Crimp Housing

70450
Dual Row
Version C, Back Ribs

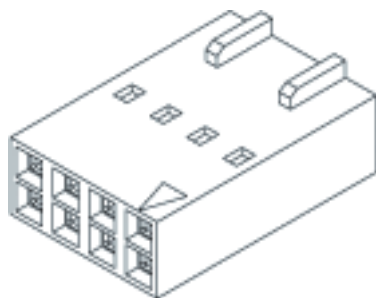

Features and Benefits

- Sizes 4 to 50 circuits
- Designed to be used within 70013 dual row interim clip as a female connector assembly or 70022 dual row panel mount as a male pin assembly
- End-to-end stackable
- Back ribs maintain position of connector housings in interim clip and panel mount

Reference Information

Product Specification: PS-70400
Packaging: Bag
UL File No.: E29179
CSA File No.: LR19980
Accessories: 70013 and 70022
Use With: 70021, 70058 and 71851 crimp terminals
Designed In: Inches

Physical

Housing: Black polyester, UL 94V-0
Operating Temperature: -40 to +105°C



Not For Use With C-Grid III™ Components

Circuits	Order No.
4	22-55-2043
6	22-55-2063
8	22-55-2083
10	22-55-2103
12	22-55-2123
14	22-55-2143
16	22-55-2163
18	22-55-2183

Circuits	Order No.
20	22-55-2203
22	22-55-2223
24	22-55-2243
26	22-55-2263
28	22-55-2283
30	22-55-2303
32	22-55-2323
34	22-55-2343

Circuits	Order No.
36	22-55-2363
38	22-55-2383
40	22-55-2403
42	22-55-2423
44	22-55-2443
46	22-55-2463
48	22-55-2483
50	22-55-2503

2.54mm (.100") Pitch SL™ Crimp Housing

70450
Dual Row
Version F

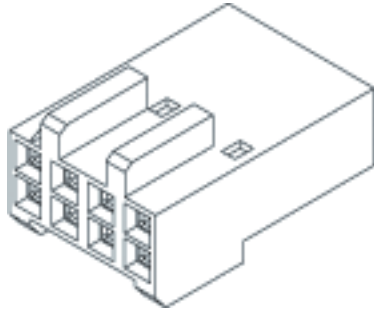

Features and Benefits

- Sizes 6 to 54 circuits
- Front guide ribs provide 180° polarization to mating connector

Reference Information

Product Specification: PS-70400

Packaging: Bag

UL File No.: E29179

CSA File No.: LR19980

Mates With: 8724, 70229, 70567, 70568 and 71349

Use With: 70058 and 71851 crimp terminals

Designed In: Inches

Physical

Housing: Black polyester, UL 94V-0

Operating Temperature: -40 to +105°C

Delivered on a carrier with 20 pieces per strip.

Actual Size  Universal Polarizing Pin
40713-1
Order No. 15-04-0292

Not For Use With C-Grid III™ Components

Circuits	Order No.
6	22-56-6067
8	22-56-6087
10	22-56-6107
12	22-56-6127
14	22-56-6147
16	22-56-6167
18	22-56-6187
20	22-56-6207
22	22-56-6227

Circuits	Order No.
24	22-56-6247
26	22-56-6267
28	22-56-6287
30	22-56-6307
32	22-56-6327
34	22-56-6347
36	22-56-6367
38	22-56-6387
40	22-56-6407

Circuits	Order No.
42	22-56-6427
44	22-56-6447
46	22-56-6467
48	22-56-6487
50	22-56-6507
52	22-56-6527
54	22-56-6547

2.54mm (.100") Pitch SL™

Specifications for Female Insulation Displacement Connector Assembly

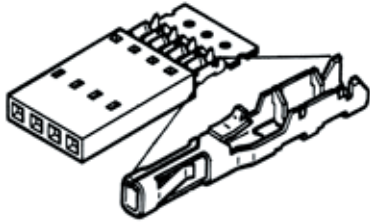

Five styles of single row IDT receptacle assemblies are available in 2 through 25 circuits. The female IDT terminal features a fully enclosed "box" design with dual beams to provide 2 points of contact.

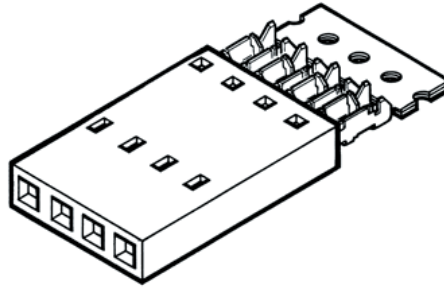

Stamped female terminals are preloaded into first window of housing for presentation of assemblies to application tooling. The carrier is color coded to identify the plating option, and the terminal is stamped with a letter code to distinguish wire gauge of the IDT slot.

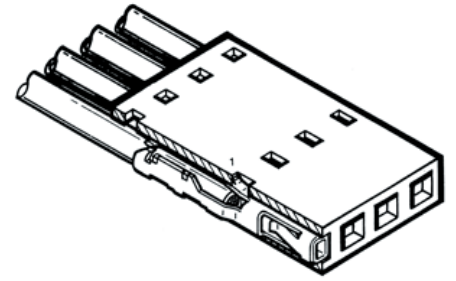

Cut away view of the IDT assembly in a loaded position. Locking tangs secure terminals in the second window.

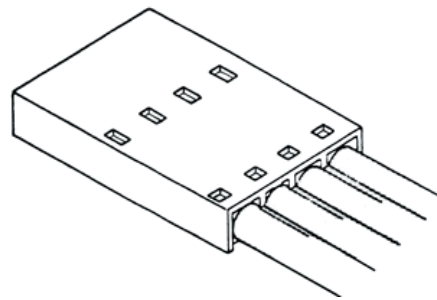

After the cable/wires are terminated, terminals are fully inserted into the housing and locked into the second window. The carrier strip is then broken off. As a result of this automated termination*, the terminals are consistently locked into the housing without damage.

Wire and Cable Options

Recommended Molex Cable Engineering No. to use with 70400 series connectors:

Accepts round conductor flat cable from 24 to 28 AWG, with .053" max. outside insulation diameter 7234, 7307, 7560, 7767, 8867, 8996, 8997, 24241, 24327, 24369 and 24389.

Discrete Wire
(Series 70066)

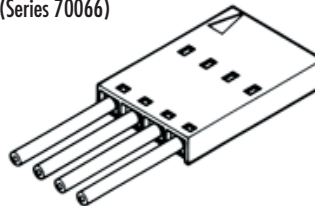

Flat Flex Cable
(Series 70430)

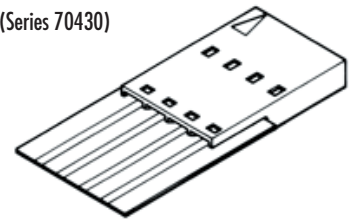

Notch Specification for Ribbon Cable

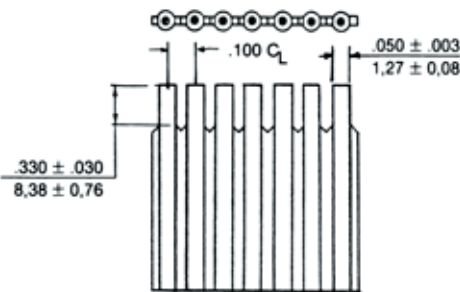

Ribbon Cable
(Series 70400)

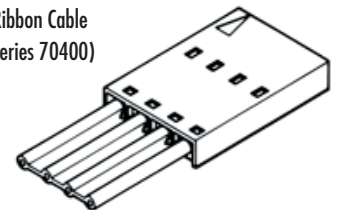

* See Application Tooling section

2.54mm (.100") Pitch SL™ Insulation Displacement Connector Assembly

70400

Female, Single Row Version A, Nonpolarized

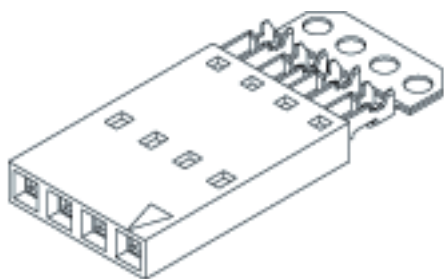

Features and Benefits

- Sizes 2 to 25 circuits
- Preloaded, single piece construction allows for fully automated termination
- Packaged in plastic tubes to allow for automated manufacturing and to minimize product handling
- End-to-end and/or side-to-side stackable for single or dual row connections to a 2.54mm (.100") pitch grid pin field

Reference Information

Product Specification: PS-70040
 Packaging: Tube
 UL File No.: E29179
 CSA File No.: LR19980
 Mates With: 2.54mm (.100") pitch, single or dual row C-Grid®, SL or KK® headers
 Use With Molex Cable: 7234, 7307, 7560, 7767, 8867, 8996, 8997, 24241, 24327, 24369 and 24389
 Designed In: Inches

Electrical

Voltage: 250V
 Current: 1.2A—28 AWG; 1.8A—26 AWG
 3.0A—24 AWG; 3.0A—22 AWG

Electrical (continued)

Contact Resistance: 15 milliohms max.
 Dielectric Withstanding Voltage: 1500V
 Insulation Resistance: 10,000 Megohms min.

Mechanical

Contact Retension to Housing: 17.79N (4 lb) min.
 Mating Force: Tin—4.15N (.93 lb) per circuit;
 Gold—3.08N (.70 lb) per circuit
 Unmating Force: Tin—2.47N (.55 lb) per circuit;
 Gold—.65N (.15 lb) per circuit
 Durability: Tin—25 cycles; Gold—50 cycles

Physical

Housing: Black polyester, UL 94V-0
 Contact: Copper Alloy
 Plating: See Table
 Operating Temperature: -40 to +105°C
 Insulation and Wire Gauge Range: .053" max. with
 22 to 28 AWG stranded discrete wire or flat
 ribbon cable

Delivered on a carrier with 20 pieces per strip.

Actual Size  Universal Polarizing Pin
 40713-1
 Order No. 15-04-0292

Not For Use With C-Grid III™ Components

Wire Accommodation (AWG)	Order No.			Lead-free
	150µm Tin	15µm Gold	30µm Gold	
28	14-60-0XX5	14-56-2XX5	14-56-3XX2	Yes
26	14-60-0XX3	14-56-2XX3	14-56-2XX9	
24	14-60-0XX1	14-56-2XX1	14-56-2XX7	
22	14-60-6XX9	14-56-7XX4	14-56-7XX9	

Replace XX with no. of circuits, 02-25

Plating Code (Stripe on Carrier Strip)		Color
Plating		
Tin		None
15µm Gold		Yellow
30µm Gold		Red

Wire Gauge Chart	
Code Stamped on Terminals	Wire Gauge (AWG)
A	24
B	26
C	28
D	22

Note: 2 circuit assemblies supplied as grouped pairs

2.54mm (.100") Pitch SL™ Insulation Displacement Connector Assembly

70400

**Female, Single Row
Version C, Front Ribs**

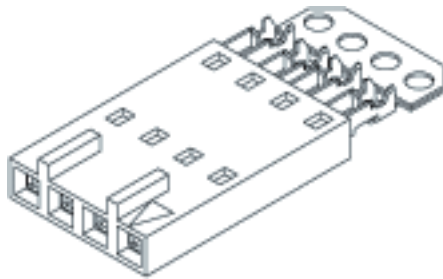

Features and Benefits

- Sizes 2 to 25 circuits
- Preloaded, single piece construction allows for fully automated termination
- Packaged in plastic tubes to allow for automated manufacturing and to minimize product handling
- Front polarizing ribs prevent pin damage during disconnect; housing cannot be twisted off pins

Reference Information

Product Specification: PS- 70400
 Packaging: Tube
 UL File No.: E29179
 CSA File No.: LR19980
 Mates With: 2.54mm (.100") pitch SL headers
 Use With Molex Cable: 7234, 7307, 7560, 7767, 8867, 8896, 8897, 24241, 24327, 24369 and 24389
 Designed In: Inches

Electrical

Voltage: 250V
 Current: 1.2A—28 AWG; 1.8A—26 AWG
 3.0A—24 AWG; 3.0A—22 AWG

Electrical (continued)

Contact Resistance: 15 milliohms max.
 Dielectric Withstanding Voltage: 1500V
 Insulation Resistance: 10,000 Megohms min.

Mechanical

Contact Retension to Housing: 17.79N (4 lb) min.
 Mating Force: Tin—4.15N (.93 lb) per circuit;
 Gold—3.08N (.70 lb) per circuit
 Unmating Force: Tin—2.47N (.55 lb) per circuit;
 Gold—.65N (.15 lb) per circuit
 Durability: Tin—25 cycles; Gold—50 cycles

Physical

Housing: Black polyester, UL 94V-0
 Contact: Copper Alloy
 Plating: See Table
 Operating Temperature: -40 to +105°C
 Insulation and Wire Gauge Range: .053" max. with
 22 to 28 AWG stranded discrete wire of flat
 ribbon cable



Not For Use With C-Grid III™ Components

Wire Accommodation (AWG)	Order No.			Lead-free
	150µ" Tin	15µ" Gold	30µ" Gold	
28	14-60-1XX1	14-56-3XX8	14-56-4XX4	Yes
26	14-60-0XX9	14-56-3XX6	14-56-4XX2	
24	14-60-0XX7	14-56-3XX5	14-56-4XX0	
22	14-56-7XX0	14-56-7XX5	14-56-8XX0	

Replace XX with no. of circuits, 02-25

Plating Code (Stripe on Carrier Strip)	
Plating	Color
Tin	None
15µ" Gold	Yellow
30µ" Gold	Red

Wire Gauge Chart	
Code Stamped on Terminals	Wire Gauge (AWG)
A	24
B	26
C	28
D	22

Note: 2 circuit assemblies supplied as grouped pairs

C

2.54mm (.100") Pitch PCB and Wire Connectors

2.54mm (.100") Pitch SL™ Insulation Displacement Connector Assembly

70400 Female, Single Row Version D, Back Ribs

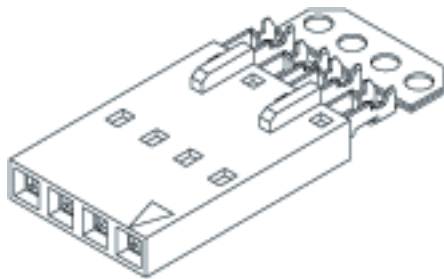

Features and Benefits

- Sizes 2 to 25 circuits
- Preloaded, single piece construction allows for fully automated termination
- Packaged in plastic tubes to allow for automated manufacturing and to minimize product handling
- Back ribs maintain position of connector assembly in clips and prevent lateral movement when another assembly is removed
- End-to-end stackable inside a single row interim clip to form a larger single row connector
- Back-to-back and end-to-end stackable inside a dual row interim clip to form a dual row connector

Reference Information

Product Specification: PS-70400
 Packaging: Tube
 UL File No.: E29179
 CSA File No.: LR19980
 Accessories: Interim clips 70004 and 70013 to form female connector assembly
 Use With Molex Cable: 7234, 7307, 7560, 7767, 8867, 8996, 8997, 24241, 24327, 24369 and 24389
 Designed In: Inches

Electrical

Voltage: 250V
 Current: 1.2A—28 AWG; 1.8A—26 AWG
 3.0A—24 AWG; 3.0A—22 AWG
 Contact Resistance: 15 milliohms max.
 Dielectric Withstanding Voltage: 1500V
 Insulation Resistance: 10,000 Megohms min.

Mechanical

Contact Retention to Housing: 17.79N (4 lb) min.
 Mating Force: Tin—4.15N (.93 lb) per circuit;
 Gold—3.08N (.70 lb) per circuit
 Unmating Force: Tin—2.47N (.55 lb) per circuit;
 Gold—.65N (.15 lb) per circuit
 Durability: Tin—25 cycles; Gold—50 cycles

Physical

Housing: Black polyester, UL 94V-0
 Contact: Copper Alloy
 Plating: See Table
 Operating Temperature: -40 to +105°C
 Insulation and Wire Gauge Range: .053" max. with 22 to 28 AWG stranded discrete wire or flat ribbon cable

Delivered on a carrier with 20 pieces per strip.

Actual Size  Universal Polarizing Pin
 40713-1
 Order No. 15-04-0292

Not For Use With C-Grid III™ Components

Wire Accommodation (AWG)	Order No.			Lead-free
	150µm Tin	15µm Gold	30µm Gold	
28	14-60-1XX2	14-56-3XX9	14-56-4XX5	Yes
26	14-60-1XX0	14-56-3XX7	14-56-4XX3	
24	14-60-0XX8	14-56-3XX4	14-56-4XX1	
22	14-56-7XX1	14-56-7XX6	14-56-8XX1	

Replace XX with no. of circuits, 02-25

Plating Code (Stripe on Carrier Strip)	
Plating	Color
Tin	None
15µm Gold	Yellow
30µm Gold	Red

Note: The circuit 1 indicator for the 70400D will be superseded by the circuit 1 indicator of the 70004 and 70013 interim clips

Wire Gauge Chart	
Code Stamped on Terminals	Wire Gauge (AWG)
A	24
B	26
C	28
D	22

Note: 2 circuit assemblies supplied as grouped pairs

2.54mm (.100") Pitch SL™ Insulation Displacement Connector Assembly

70400 Female, Single Row Version G, Positive Latch

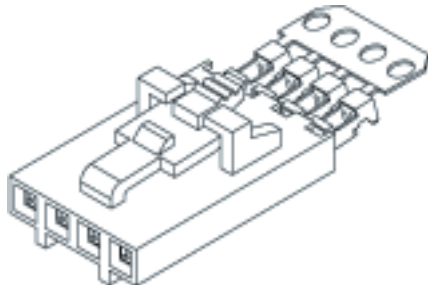

Features and Benefits

- Sizes 2 to 25 circuits
- Preloaded, single piece construction allows for fully automated termination
- Packaged in plastic tubes to allow for automated manufacturing and to minimize product handling
- Positive latch secures connector to mating header or panel mount
- Front ribs prevent housing from being twisted off pins
- Anti-entanglement/overstress ribs prevent discrete wires from catching under latch during harness manufacturing and storage

Reference Information

Product Specification: PS-70400
 Packaging: Tube
 UL File No.: E29179
 CSA File No.: LR19980
 Mates With: 70018, 70107 A/B, 70541, 70543, 70545, 70551, 70553, 70555, 70634 and 74099
 Use With Molex Cable: 7234, 7307, 7560, 7767, 8867, 8996, 8997, 24241, 24327, 24369 and 24389
 Designed In: Inches

Electrical

Voltage: 250V
 Current: 1.2A—28 AWG; 1.8A—26 AWG
 3.0A—24 AWG; 3.0A—22 AWG
 Contact Resistance: 15 milliohms max.
 Dielectric Withstanding Voltage: 1500V
 Insulation Resistance: 10,000 Megohms min.

Mechanical

Contact Retension to Housing: 17.79N (4 lb) min.
 Mating Force: Tin—4.15N (.93 lb) per circuit;
 Gold—3.08N (.70 lb) per circuit
 Unmating Force: Tin—2.47N (.55 lb) per circuit;
 Gold—.65N (.15 lb) per circuit
 Durability: Tin—25 cycles; Gold—50 cycles

Physical

Housing: Black polyester, UL 94V-0
 Contact: Copper Alloy
 Plating: See Table
 Operating Temperature: -40 to +105°C
 Insulation and Wire Gauge Range: .053" max. with 22 to 28 AWG stranded discrete wire or flat ribbon cable

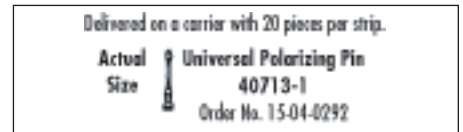

Not For Use With C-Grid III™ Components

Wire Accommodation (AWG)	Order No.			Lead-free
	150µm Tin	15µm Gold	30µm Gold	
28	14-60-0XX6	14-56-2XX6	14-56-3XX3	Yes
26	14-60-0XX4	14-56-2XX4	14-56-3XX1	
24	14-60-0XX2	14-56-2XX2	14-56-2XX8	
22	14-56-7XX2	14-56-7XX7	14-56-8XX2	

Replace XX with no. of circuits, 02-25

Plating Code (Stripe on Carrier Strip)		Color
Plating		
Tin		None
15µm Gold		Yellow
30µm Gold		Red

Wire Gauge Chart	
Code Stamped on Terminals	Wire Gauge (AWG)
A	24
B	26
C	28
D	22

Note: 2 circuit assemblies supplied as grouped pairs

2.54mm (.100") Pitch SL™

Specifications for Male Insulation Displacement Connector Assembly

2.54mm (.100") Pitch PCB and Wire Connectors

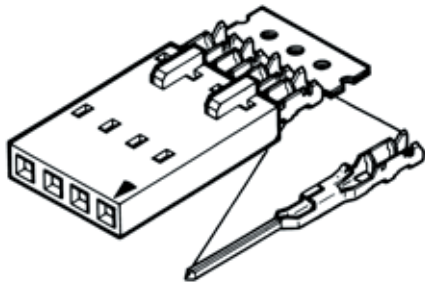

Shown: 70475 "D" Version Connector

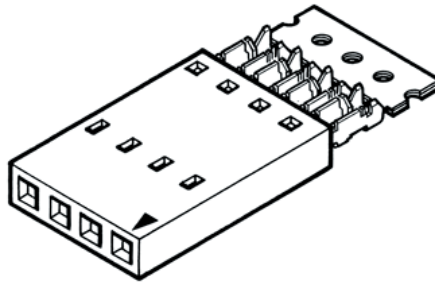

Stamped male terminals are preloaded into first window of housing for presentation of assemblies to application tooling. The carrier is color coded to identify the plating option, and the terminal is stamped with a letter code to distinguish wire gauge of the IDT slot.

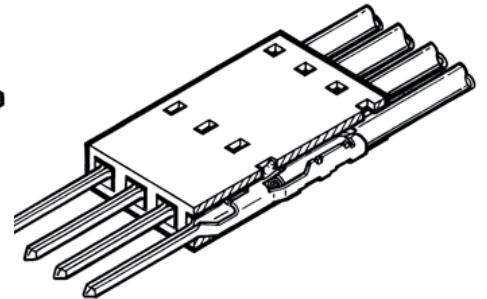

After the cable/wires are terminated, terminals are fully inserted into the housing and locked into the second window. The carrier strip is then broken off. As a result of this automated termination*, the terminals are consistently locked into the housing without damage.

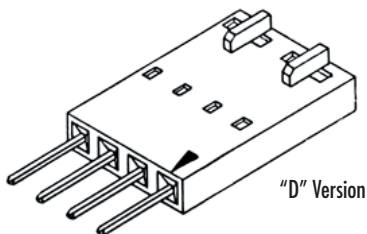

"D" Version

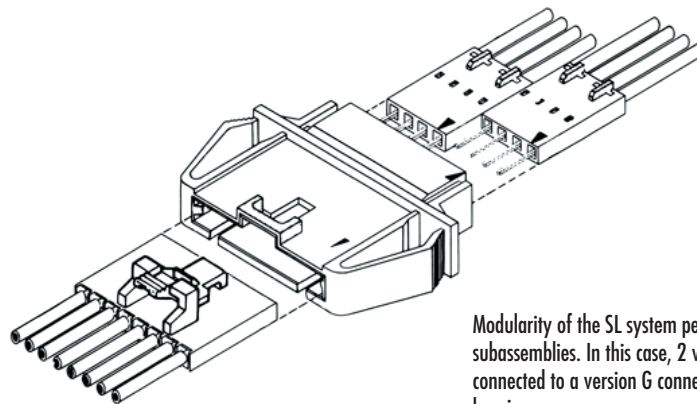

Modularity of the SL system permits gang loading of subassemblies. In this case, 2 version D pin assemblies are connected to a version G connector through a panel mount housing.

Wire and Cable Options

Recommended Molex Cable Engineering No. to use with 70400 Series connectors: 7234, 7307, 7560, 7767, 8867, 8996, 8997, 24241, 24327, 24369 and 24389

Notch Specification for Ribbon Cable

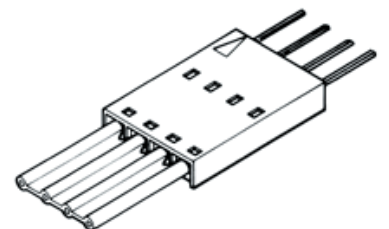
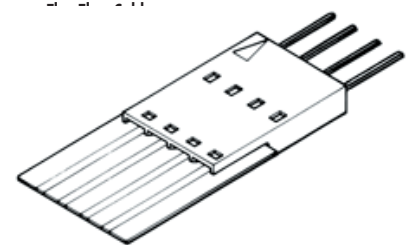
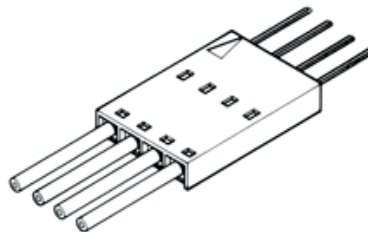
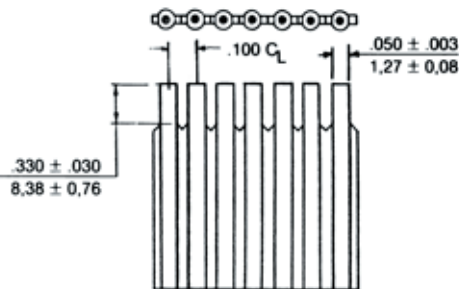

* See Application Tooling section

2.54mm (.100") Pitch SL™ Insulation Displacement Connector Assembly

70475

**Male, Single Row
Version D, Back Ribs**

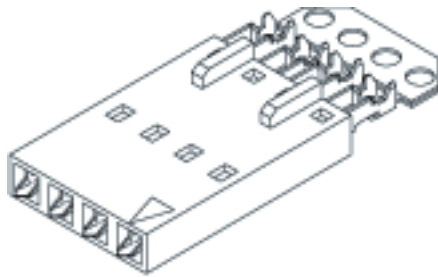

Features and Benefit

- Sizes 2 to 25 circuits
- Preloaded, single-piece construction allows for fully automated termination
- Packaged in plastic tubes to allow for automated manufacturing and to minimize product handling
- Back ribs maintain position of connector assembly in clips; prevents lateral movement when another assembly is removed
- End-to-end stackable inside a single row panel mount connector to form a larger single row connector
- Back-to-back and end-to-end stackable inside a dual row panel mount connector to form a dual row connector

Reference Information

Product Specification: PS-70475

Packaging: Tube

UL File No.: E29179

CSA File No.: LR19980

Accessories: Panel mount connectors 70018, 70022 and 70104 to form a male pin assembly

Mates with: 70058 and 71851 female crimp terminals, 70400 and 70430 connector assemblies and 0.64mm (.025") Square pins.

Use With Molex Cable: 7234, 7307, 7560, 7767, 8867, 8996, 8997, 24241, 24327, 24369 and 24389

Designed In: Inches

Electrical

Voltage: 250V

Current: 1.2A—28 AWG; 1.8A—26 AWG
3.0A—24 AWG; 3.0A—22 AWG

Contact Resistance: 15 milliohms max.

Dielectric Withstanding Voltage: 1500V

Insulation Resistance: 10,000 Megohms min.

Mechanical

Contact Retension to Housing: 17.79N (4 lb) min.

Mating Force: Tin—4.15N (.93 lb) per circuit;

Gold—3.08N (.70 lb) per circuit

Unmating Force: Tin—2.47N (.55 lb) per circuit;

Gold—.65N (.15 lb) per circuit

Durability: Tin—25 cycles; Gold—50 cycles

Physical

Housing: Black polyester, UL 94V-0

Contact: Copper Alloy

Plating: See Table

Operating Temperature: -40 to +105°C

Insulation and Wire Gauge Range: .053" max. with 22 to 28 AWG stranded discrete wire or flat ribbon cable

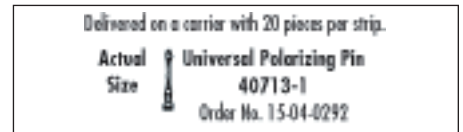

Not For Use With C-Grid III™ Components

Wire Accommodation (AWG)	Order No.			Lead-free
	150µ" Tin	15µ" Gold	30µ" Gold	
28	14-45-18XX	14-44-21XX	14-44-49XX	Yes
26	14-45-06XX	14-44-16XX	14-44-29XX	
24	14-45-02XX	14-44-12XX	14-44-29XX	
22	14-44-52XX	14-44-53XX	14-44-54XX	

Replace XX with no. of circuits, 02-25

Housing version D mates with female connectors when used in panel mount

Plating Code (Stripe on Carrier Strip)	
Plating	Color
Tin	None
15µ" Gold	Yellow
30µ" Gold	Red

Wire Gauge Chart	
Code Stamped on Terminals	Wire Gauge (AWG)
A	24
B	26
C	28
D	22

Note: 2 circuit assemblies supplied as grouped pairs

C

2.54mm (.100") Pitch PCB and Wire Connectors

2.54mm (.100") Pitch SL™ Wire-to-Wire Connector

70107 Single Row, Version A Without Mounting Ears

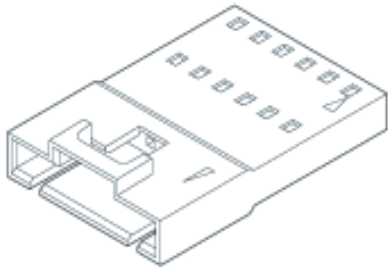

Not For Use With C-Grid III™ Components

Circuits	Order No.
2	70107-0001
3	70107-0002
4	70107-0003
5	70107-0004
6	70107-0005
7	70107-0006
8	70107-0007
9	70107-0008

Features and Benefits

- Sizes 2 to 25 circuits
- Used primarily for remote interconnections
- Locking crown secures positive latch to connector
- Polarization slots guide front ribs of mating connector to prevent pin damage

Reference Information

Product Specification: PS-70021
 Packaging: Bag
 UL File No.: E29179
 CSA File No.: LR19980
 Mates With: 70066G, 70066N, 70400G and 70430G
 connector assemblies
 Use With: 70021 crimp terminals
 Designed In: Inches

Physical

Housing: Black polyester, UL 94V-0
 Operating Temperature: -40 to +105°C

2.54mm (.100") Pitch SL™ Wire-to-Wire Panel Mount Connector

70107 Single Row, Version B With Mounting Ears

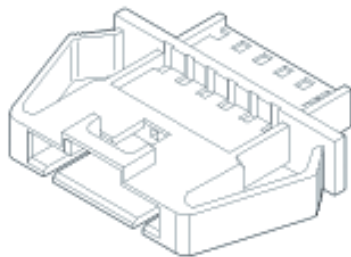

Not For Use With C-Grid III™ Components

Circuits	Order No.
2	70107-0036
3	70107-0037
4	70107-0038
5	70107-0039
6	70107-0040
7	70107-0041
8	70107-0042
9	70107-0043

Features and Benefits

- Sizes 2 to 25 circuits
- Used primarily for remote interconnections
- Locking crown secures positive latch to connector
- Polarization slots guide front ribs of mating connector to prevent pin damage
- Mounting ears for insertion into .030 to .090" thick panels

Reference Information

Product Specification: PS-70021
 Packaging: Bag
 UL File No.: E29179
 CSA File No.: LR19980
 Mates With: 70066G, 70066N, 70400G and 70430G
 connector assemblies
 Use With: 70021 crimp terminals
 Designed In: Inches

Physical

Housing: Black polyester, UL 94V-0
 Operating Temperature: -40 to +105°C

Circuits	Order No.
10	70107-0009
11	70107-0010
12	70107-0011
13	70107-0012
14	70107-0013
15	70107-0014
16	70107-0015
17	70107-0016

Circuits	Order No.
18	70107-0017
19	70107-0018
20	70107-0019
21	70107-0020
22	70107-0021
23	70107-0022
24	70107-0023
25	70107-0024

2.54mm (.100") Pitch SL™ Wire-to-Wire Panel Mount Connector

70018
Single Row
Modular Branch

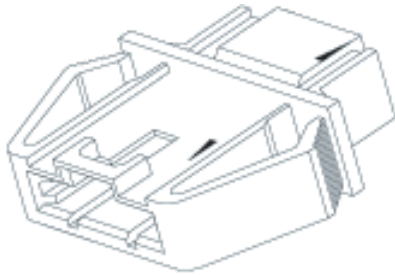

Features and Benefits

- Sizes 2 to 25 circuits
- Used primarily for remote interconnections
- Locking crown secures positive latch to connector
- Polarization slots guide front ribs of mating connector to prevent pin damage
- Mounting ears for insertion into .030 to .090" thick panels
- Mates modular branch pin assemblies to single connector assembly

Reference Information

Packaging: Bag
UL File No.: E29179
CSA File No.: LR19980
Mates With: 70066G, 70066N, 70400G and 70430G front side, and 70066D and 70475D pin assemblies back side
Designed In: Inches

Physical

Housing: Black polyester, UL 94V-0
Operating Temperature: -40 to +105°C

Not For Use With Molex C-Grid III™ Components

Circuits	Order No.
2	50-65-0202
3	50-65-0203
4	50-65-0204
5	50-65-0205
6	50-65-0206
7	50-65-0207
8	50-65-0208
9	50-65-0209

Circuits	Order No.
10	50-65-0210
11	50-65-0211
12	50-65-0212
13	50-65-0213
14	50-65-0214
15	50-65-0215
16	50-65-0216
17	50-65-0217

Circuits	Order No.
18	50-65-0218
19	50-65-0219
20	50-65-0220
21	50-65-0221
22	50-65-0222
23	50-65-0223
24	50-65-0224
25	50-65-0225

2.54mm (.100") Pitch SL™ Wire-to-Wire Panel Mount Connector

70104
Single Row
Modular Branch

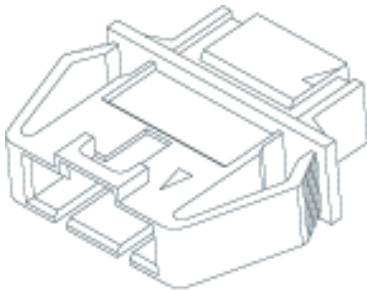

Features and Benefits

- Sizes 4 to 25 circuits
- Used primarily for remote interconnections
- Locking crown secures positive latch to connector
- Polarization slots guide front ribs of mating connector to prevent pin damage
- Mounting ears for insertion into .030 to .090" thick panels
- Mates single or modular branch pin assemblies with modular branch connector assemblies in an interim clip

Reference Information

Packaging: Bag
UL File No.: E29179
CSA File No.: LR19980
Mates With: 70004 front side, and 70066D and 70475D pin assemblies back side
Designed In: Inches

Physical

Housing: Black polyester, UL 94V-0
Operating Temperature: -40 to +105°C

Not For Use With Molex C-Grid III™ Components

Circuits	Order No.
4	50-65-0104
5	50-65-0105
6	50-65-0106
7	50-65-0107
8	50-65-0108
9	50-65-0109
10	50-65-0110
11	50-65-0111

Circuits	Order No.
12	50-65-0112
13	50-65-0113
14	50-65-0114
15	50-65-0115
16	50-65-0116
17	50-65-0117
18	50-65-0118
19	50-65-0119

Circuits	Order No.
20	50-65-0120
21	50-65-0121
22	50-65-0122
23	50-65-0123
24	50-65-0124
25	50-65-0125

2.54mm (.100") Pitch SL™ Wire-to-Wire Panel Mount Connector

70022 Dual Row Modular Branch

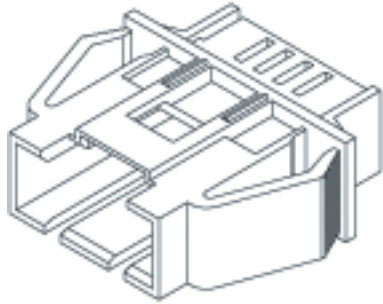

Not For Use With Molex C-Grid III™ Components

Circuits	Order No.
6	50-65-0006
8	50-65-0008
10	50-65-0010
12	50-65-0012
14	50-65-0014
16	50-65-0016
18	50-65-0018
20	50-65-0020

Features and Benefits

- Sizes 6 to 50 circuits
- Used primarily for high density remote interconnections
- Locking crown secures positive latch to connector
- Polarization slots guide front ribs of mating connector to prevent pin damage
- Mates modular branch pin assemblies to modular branch connector assemblies in a dual row configuration

Reference Information

Packaging: Bag
 UL File No.: E29179
 CSA File No.: LR19980
 Mates With: 70013 interim clip front side, and side-to-side stacked 70066D and 70475D on back side
 Designed In: Inches

Physical

Housing: Black polyester, UL 94V-0
 Operating Temperature: -40 to +105°C

Circuits	Order No.
22	50-65-0022
24	50-65-0024
26	50-65-0026
28	50-65-0028
30	50-65-0030
32	50-65-0032
34	50-65-0034
36	50-65-0036

Circuits	Order No.
38	50-65-0038
40	50-65-0040
42	50-65-0042
44	50-65-0051
46	50-65-0046
48	50-65-0048
50	50-65-0050

2.54mm (.100") Pitch SL™ Interim Clip 70004 Single Row Modular Branch

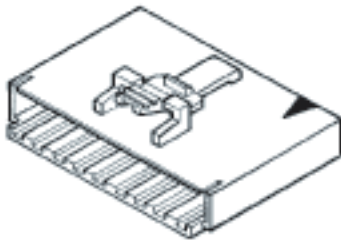

Not For Use With Molex C-Grid III™ Components

Circuits	Order No.
4	15-04-5042
5	15-04-5052
6	15-04-5062
7	15-04-5072
8	15-04-5082
9	15-04-5092
10	15-04-5102
11	15-04-5112

Features and Benefits

- Sizes 4 to 25 circuits
- Positive latch retains clip to panel mount or 180° pocket headers
- Anti-entanglement/overstress ribs prevent discrete wires from catching under latch during harness manufacturing and storage
- Stacks 70066/70400D assemblies end-to-end to form a larger single row connector

Reference Information

UL File No.: E29179
 CSA File No.: LR19980
 Mates With: 70104, 70563 and 70575
 Designed In: Inches

Physical

Housing: Black polyester, UL 94V-0
 Operating Temperature: -40 to +105°C

Circuits	Order No.
12	15-04-5122
13	15-04-5132
14	15-04-5142
15	15-04-5152
16	15-04-5162
17	15-04-5172
18	15-04-5182
19	15-04-5192

Circuits	Order No.
20	15-04-5202
21	15-04-5212
22	15-04-5222
23	15-04-5232
24	15-04-5242
25	15-04-5252

2.54mm (.100") Pitch

SL™

Interim Clip

70013

Dual Row

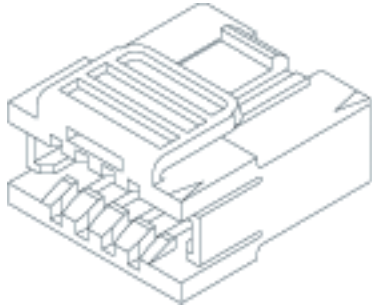

Not For Use With Molex C-Grid III™ Components

Circuits	Order No.	
	Version A Without Ribs	Version B With Ribs
6	15-04-5061	15-04-5064
8	15-04-5081	15-04-5084
10	15-04-5101	15-04-5104
12	15-04-5121	15-04-5124
14	15-04-5141	15-04-5144
16	15-04-5161	15-04-5164
18	15-04-5181	15-04-5184
20	15-04-5201	15-04-5204

Features and Benefits

- Sizes 6 to 50 circuits
- Positive latch retains clip to dual row panel mount or headers
- Optional front polarization rib available (version B)
- Stacks single row 70066/70400D assemblies side-to-side and end-to-end to form a larger dual row connector, accepts 70450C dual row connector to provide positive latch feature

Reference Information

Packaging: Bag
 UL File No.: E29179
 CSA File No.: LR19980
 Mates With: 70013, Version A—8724B and 70567B
 70013, Version B—70022, 70567C, 70568,
 71349 and 70229

Use With: 70066D housing and 70021 terminals, 70450C housing and 70021 terminals, 70430D and 70400D connector assemblies

Designed In: Inches

Physical

Housing: Black polyester, UL 94V-0
 Operating Temperature: -40 to +105°C

C

2.54mm (.100") Pitch PCB and Wire Connectors

2.54mm (.100") Pitch

SL™

Wire-to-Board Shrouded Header

70543

Single Row, .120" Pocket Vertical

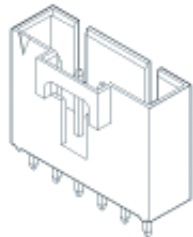

Not For Use With C-Grid III™ Components

Circuits	Order No.			Lead-free
	150µm Tin	15µm Gold	30µm Gold	
2	70543-0036	70543-0001	70543-0106	Yes
3	70543-0037	70543-0002	70543-0107	
4	70543-0038	70543-0003	70543-0108	
5	70543-0039	70543-0004	70543-0109	
6	70543-0040	70543-0005	70543-0110	
7	70543-0041	70543-0006	70543-0111	
8	70543-0042	70543-0007	70543-0112	
9	70543-0043	70543-0008	70543-0113	
10	70543-0044	70543-0009	70543-0114	
11	70543-0045	70543-0010	70543-0115	
12	70543-0046	70543-0011	70543-0116	
13	70543-0047	70543-0012	70543-0117	

Features and Benefits

- Sizes 2 to 25 circuits
- Locking crown secures positive latch to header
- Polarization slots guide front ribs of mating connector to prevent pin damage
- Standoffs minimize flux retention

Reference Information

Product Specification: PS-70541
 Packaging: Tube
 UL File No.: E29179
 CSA File No.: LR19980
 Mates With: 70066G, 70066N, 70400G and 70430G
 Designed In: Inches

Electrical

Voltage: 250V
 Current: 3.0A
 Contact Resistance: 15 milliohms max.
 Dielectric Withstanding Voltage: 1500V
 Insulation Resistance: 10,000 Megohms min.

Mechanical

Durability: Tin—25 cycles; Gold—50 cycles

Physical

Housing: Black polyester, UL 94V-0
 Contact: Copper Alloy
 Plating: See Table
 Operating Temperature: -40 to +105°C

Circuits	Order No.			Lead-free
	150µm Tin	15µm Gold	30µm Gold	
14	70543-0048	70543-0013	70543-0118	Yes
15	70543-0049	70543-0014	70543-0119	
16	70543-0050	70543-0015	70543-0120	
17	70543-0051	70543-0016	70543-0121	
18	70543-0052	70543-0017	70543-0122	
19	70543-0053	70543-0018	70543-0123	
20	70543-0054	70543-0019	70543-0124	
21	70543-0055	70543-0020	70543-0125	
22	70543-0056	70543-0021	70543-0126	
23	70543-0057	70543-0022	70543-0127	
24	70543-0058	70543-0023	70543-0128	
25	70543-0059	70543-0024	70543-0129	

2.54mm (.100") Pitch SL™ Wire-to-Board Shrouded Header

74099

Single Row, .120" Pocket Vertical, SMT

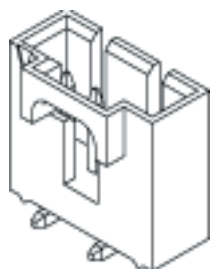

Features and Benefits

- Size 3 to 24 circuits
- Locking crown secures positive latch to header
- Polarization slots guide front ribs of mating connector to prevent pin damage
- Standoffs minimize flux interference
- Surface Mount Compatible

Reference Information

Product Specification: PS-70541
Packaging: Tube
UL File No.: E29179
CSA File No.: LR19980
Mates with: 70066G, 70066N, 70400G and 70430G
Designed In: Inches

Electrical

Voltage: 250V
Current: 3.0A
Contact Resistance: 15 milliohms max.
Dielectric Withstanding Voltage: 1500V
Insulation Resistance: 1000 Megohms min.

Mechanical

Durability: Tin—25 cycles; Gold—50 cycles

Physical

Housing: Black polyester, UL 94V-0
Contact: Copper Alloy
Plating: See Table
Operating Temperature: -40 to +105°C

Not For Use With C-Grid III™ Components

	Tin	15µm Gold	30µm Gold	Lead-free
3	74099-0003	74099-1003	74099-2003	Yes
4	74099-0004	74099-1004	74099-2004	
5	74099-0005	74099-1005	74099-2005	
6	74099-0006	74099-1006	74099-2006	
7	74099-0007	74099-1007	74099-2007	
8	74099-0008	74099-1008	74099-2008	
9	74099-0009	74099-1009	74099-2009	
10	74099-0010	74099-1010	74099-2010	
11	74099-0011	74099-1011	74099-2011	
12	74099-0012	74099-1012	74099-2012	
13	74099-0013	74099-1013	74099-2013	

	Tin	15µm Gold	30µm Gold	Lead-free
14	74099-0014	74099-1014	74099-2014	Yes
15	74099-0015	74099-1015	74099-2015	
16	74099-0016	74099-1016	74099-2016	
17	74099-0017	74099-1017	74099-2017	
18	74099-0018	74099-1018	74099-2018	
19	74099-0019	74099-1019	74099-2019	
20	74099-0020	74099-1020	74099-2020	
21	74099-0021	74099-1021	74099-2021	
22	74099-0022	74099-1022	74099-2022	
23	74099-0023	74099-1023	74099-2023	
24	74099-0024	74099-1024	74099-2024	

2.54mm (.100") Pitch SL™ Wire-to-Board Shrouded Header

70541

Single Row, .120" Pocket Vertical, Split Pegs

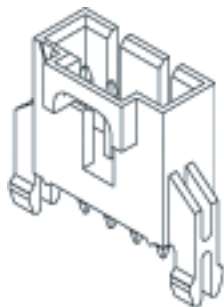

Features and Benefits

- Size 2 to 10 circuits
- PCB locks hold header in place until permanently soldered
- Locking crown secures positive latch to header
- Polarization slots guide front ribs of mating connector to prevent pin damage
- Standoffs minimize flux retention

Reference Information

Product Specification: PS-70541
Packaging: Tube
UL File No.: E29179
CSA File No.: LR19980
Mates With: 70066G, 70066N, 70400G and 70430G
Designed In: Inches

Electrical

Voltage: 250V
Current: 3.0A
Contact Resistance: 15 milliohms max.
Dielectric Withstanding Voltage: 1500V
Insulation Resistance: 1000 Megohms min.

Mechanical

Insertion Force to PCB: 44.5 N (10 lb)
Durability: Tin—25 cycles; Gold—50 cycles

Physical

Housing: Black polyester, UL 94V-0
Contact: Copper Alloy
Plating: See Table
Operating Temperature: -40 to +105°C

Not For Use With C-Grid III™ Components

Circuits	Order No.			Lead-free
	15µm Min. Gold	30µm Min. Gold	150µm Tin	
2	70541-0036	70541-0071	70541-0001	Yes
3	70541-0037	70541-0072	70541-0002	
4	70541-0038	70541-0073	70541-0003	
5	70541-0039	70541-0074	70541-0004	
6	70541-0040	70541-0075	70541-0005	

Circuits	Order No.			Lead-free
	15µm Min. Gold	30µm Min. Gold	150µm Tin	
7	70541-0041	70541-0076	70541-0006	Yes
8	70541-0042	70541-0077	70541-0007	
9	70541-0043	70541-0078	70541-0008	
10	70541-0044	70541-0079	70541-0009	

2.54mm (.100") Pitch SL™ Wire-to-Board Shrouded Header

70545
Single Row, .120" Pocket
Vertical, Tri-Peg

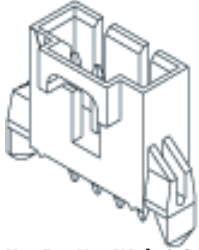

Features and Benefits

- Size 2 to 25 circuits
- PCB locks hold header in place until permanently soldered
- Locking crown secures positive latch to header
- Polarization slots guide front ribs of mating connector to prevent pin damage
- Standoffs minimize flux retention

Reference Information

Product Specification: PS-70541
Packaging: Tube
UL File No.: E29179
CSA File No.: LR19980
Mates With: 70066G, 70066N, 70400G and 70430G
Designed In: Inches

Electrical

Voltage: 250V
Current: 3.0A
Contact Resistance: 15 milliohms max.
Dielectric Withstanding Voltage: 1500V
Insulation Resistance: 10,000 Megohms min.

Mechanical

Insertion Force to PCB: 44.50N (10 lb)
Durability: Tin—25 cycles; Gold—50 cycles

Physical

Housing: Black polyester, UL 94V-0
Contact: Copper Alloy
Plating: See Table
Operating Temperature: -40 to +105°C

Not For Use With C-Grid III™ Components

Circuits	Order No.			Lead-free
	150µm Tin	15µm Gold	30µm Gold	
2	70545-0001	70545-0036	70545-0071	Yes
3	70545-0002	70545-0037	70545-0072	
4	70545-0003	70545-0038	70545-0073	
5	70545-0004	70545-0039	70545-0074	
6	70545-0005	70545-0040	70545-0075	
7	70545-0006	70545-0041	70545-0076	
8	70545-0007	70545-0042	70545-0077	
9	70545-0008	70545-0043	70545-0078	
10	70545-0009	70545-0044	70545-0079	
11	70545-0010	70545-0045	70545-0080	
12	70545-0011	70545-0046	70545-0081	
13	70545-0012	70545-0047	70545-0082	

Circuits	Order No.			Lead-free
	150µm Tin	15µm Gold	30µm Gold	
14	70545-0013	70545-0048	70545-0083	Yes
15	70545-0014	70545-0049	70545-0084	
16	70545-0015	70545-0050	70545-0085	
17	70545-0016	70545-0051	70545-0086	
18	70545-0017	70545-0052	70545-0087	
19	70545-0018	70545-0053	70545-0088	
20	70545-0019	70545-0054	70545-0089	
21	70545-0020	70545-0055	70545-0090	
22	70545-0021	70545-0056	70545-0091	
23	70545-0022	70545-0057	70545-0092	
24	70545-0023	70545-0058	70545-0093	
25	70545-0024	70545-0059	70545-0094	

2.54mm (.100") Pitch SL™ Wire-to-Board Shrouded Header

70553
Single Row, .120" Pocket
Right Angle, Low Profile

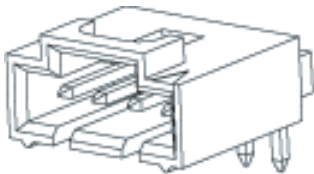

Features and Benefits

- Sizes 2 to 25 circuits
- Locking crown secures positive latch to header
- Polarization slots guide front ribs of mating connector to prevent pin damage
- Standoffs minimize flux retention

Reference Information

Product Specification: PS-70541
Packaging: Tube
UL File No.: E29179
CSA File No.: LR19980
Mates With: 70066G, 70066N, 70400G and 70430G
Designed In: Inches

Electrical

Voltage: 250V
Current: 3.0A
Contact Resistance: 15 milliohms max.
Dielectric Withstanding Voltage: 1500V
Insulation Resistance: 10,000 Megohms min.

Mechanical

Durability: Tin—25 cycles; Gold—50 cycles

Physical

Housing: Black polyester, UL 94V-0
Contact: Copper Alloy
Plating: See Table
Operating Temperature: -40 to +105°C

Not For Use With C-Grid III™ Components

Circuits	Order No.			Lead-free
	150µm Tin	15µm Gold	30µm Gold	
2	70553-0036	70553-0001	70553-0106	Yes
3	70553-0037	70553-0002	70553-0107	
4	70553-0038	70553-0003	70553-0108	
5	70553-0039	70553-0004	70553-0109	
6	70553-0040	70553-0005	70553-0110	
7	70553-0041	70553-0006	70553-0111	
8	70553-0042	70553-0007	70553-0112	
9	70553-0043	70553-0008	70553-0113	
10	70553-0044	70553-0009	70553-0114	
11	70553-0045	70553-0010	70553-0115	
12	70553-0046	70553-0011	70553-0116	
13	70553-0047	70553-0012	70553-0117	

Circuits	Order No.			Lead-free
	150µm Tin	15µm Gold	30µm Gold	
14	70553-0048	70553-0013	70553-0118	Yes
15	70553-0049	70553-0014	70553-0119	
16	70553-0050	70553-0015	70553-0120	
17	70553-0051	70553-0016	70553-0121	
18	70553-0052	70553-0017	70553-0122	
19	70553-0053	70553-0018	70553-0123	
20	70553-0054	70553-0019	70553-0124	
21	70553-0055	70553-0020	70553-0125	
22	70553-0056	70553-0021	70553-0126	
23	70553-0057	70553-0022	70553-0127	
24	70553-0058	70553-0023	70553-0128	
25	70553-0059	70553-0024	70553-0129	

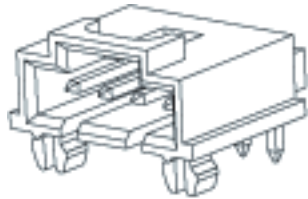
2.54mm (.100") Pitch**SL™****Wire-to-Board
Shrouded Header****70551****Single Row, .120" Pocket
Right Angle, Split Peg****Features and Benefits**

- Sizes 2 to 25 circuits
- PCB locks hold header in place until permanently soldered
- Locking crown secures positive latch connector to header
- Polarization slots guide front ribs of mating connector to prevent pin damage
- Standoffs minimize flux retention

Reference Information

Product Specification: PS-70541
 Packaging: Tube
 UL File No.: E29179
 CSA File No.: LR19980
 Mates with: 70066, 70066N, 70400 and 70430G
 Designed in: Inches

Electrical

Voltage: 250V
 Current: 3.0A
 Contact Resistance: 15 milliohms max.
 Dielectric Withstanding Voltage: 1500V
 Insulation Resistance: 10,000 Megohms min.

Mechanical

Insertion force to PCB: 44.48N (10 lbs.)
 Durability: Tin — 25 cycles; Gold — 50 cycles

Physical

Housing: Black polyester, UL 94V-0
 Contact: Copper Alloy
 Plating: See Table
 Operating Temperature: -40 to +105°C

Circuits	Order No.			Lead-free
	150 μ m Tin	15 μ m Gold	30 μ m Gold	
2	70551-0001	70551-0036	70551-0071	Yes
3	70551-0002	70551-0037	70551-0072	
4	70551-0003	70551-0038	70551-0073	
5	70551-0004	70551-0039	70551-0074	
6	70551-0005	70551-0040	70551-0075	
7	70551-0006	70551-0041	70551-0076	
8	70551-0007	70551-0042	70551-0077	
9	70551-0008	70551-0043	70551-0078	
10	70551-0009	70551-0044	70551-0079	
11	70551-0010	70551-0045	70551-0080	
12	70551-0011	70551-0046	70551-0081	
13	70551-0012	70551-0047	70551-0082	

Circuits	Order No.			Lead-free
	150 μ m Tin	15 μ m Gold	30 μ m Gold	
14	70551-0013	70551-0048	70551-0083	Yes
15	70551-0014	70551-0049	70551-0084	
16	70551-0015	70551-0050	70551-0085	
17	70551-0016	70551-0051	70551-0086	
18	70551-0017	70551-0052	70551-0087	
19	70551-0018	70551-0053	70551-0088	
20	70551-0019	70551-0054	70551-0089	
21	70551-0020	70551-0055	70551-0090	
22	70551-0021	70551-0056	70551-0091	
23	70551-0022	70551-0057	70551-0092	
24	70551-0023	70551-0058	70551-0093	
25	70551-0024	70551-0059	70551-0094	

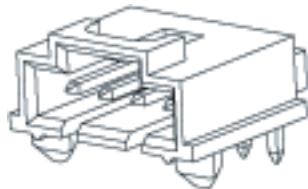
2.54mm (.100") Pitch**SL™****Wire-to-Board
Shrouded Header****70555****Single Row, .120" Pocket
Right Angle, Low Profile
Tri-Peg****Features and Benefits**

- Sizes 2 to 25 circuits
- PCB locks hold header in place until permanently soldered
- Locking crown secures positive latch to header
- Polarization slots guide front ribs of mating connector to prevent pin damage
- Standoffs minimize flux retention

Reference Information

Product Specification: PS-70541
 Packaging: Tube
 UL File No.: E29179
 CSA File No.: LR19980
 Mates With: 70066G, 70066N, 70400G and 70430G
 Designed In: Inches

Electrical

Voltage: 250V
 Current: 3.0A
 Contact Resistance: 15 milliohms max.
 Dielectric Withstanding Voltage: 1500V
 Insulation Resistance: 10,000 Megohms min.

Mechanical

Insertion Force to PCB: 44.50N (10 lb)
 Durability: Tin—25 cycles; Gold—50 cycles

Physical

Housing: Black polyester, UL 94V-0
 Contact: Copper Alloy
 Plating: See Table
 Operating Temperature: -40 to +105°C

Not For Use With C-Grid III™ Components

Circuits	Order No.			Lead-free
	150 μ m Tin	15 μ m Gold	30 μ m Gold	
2	70555-0001	70555-0036	70555-0071	Yes
3	70555-0002	70555-0037	70555-0072	
4	70555-0003	70555-0038	70555-0073	
5	70555-0004	70555-0039	70555-0074	
6	70555-0005	70555-0040	70555-0075	
7	70555-0006	70555-0041	70555-0076	
8	70555-0007	70555-0042	70555-0077	
9	70555-0008	70555-0043	70555-0078	
10	70555-0009	70555-0044	70555-0079	
11	70555-0010	70555-0045	70555-0080	
12	70555-0011	70555-0046	70555-0081	
13	70555-0012	70555-0047	70555-0082	

Circuits	Order No.			Lead-free
	150 μ m Tin	15 μ m Gold	30 μ m Gold	
14	70555-0013	70555-0048	70555-0083	Yes
15	70555-0014	70555-0049	70555-0084	
16	70555-0015	70555-0050	70555-0085	
17	70555-0016	70555-0051	70555-0086	
18	70555-0017	70555-0052	70555-0087	
19	70555-0018	70555-0053	70555-0088	
20	70555-0019	70555-0054	70555-0089	
21	70555-0020	70555-0055	70555-0090	
22	70555-0021	70555-0056	70555-0091	
23	70555-0022	70555-0057	70555-0092	
24	70555-0023	70555-0058	70555-0093	
25	70555-0024	70555-0059	70555-0094	

2.54mm (.100") Pitch SL™ Wire-to-Board Shrouded Header

70634
Single Row, .120" Pocket
Right Angle, Low Profile
SMT with Tri Peg

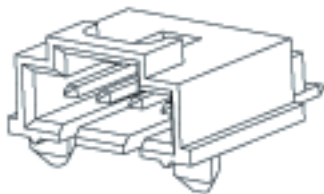

Features and Benefits

- Sizes 2 to 25 circuits
- Press-fit peg maximizes retention to PCB during soldering process
- Locking crown secures positive latch to header
- Standoffs minimize flux interference

Reference Information

Product Specification: PS-70541
Packaging: Tube
UL File No.: E29179
CSA File No.: LR19980
Mates with: 70066G, 70066N, 70400G and 70430G
Designed in: Inches

Electrical

Voltage: 250V
Current: 3.0A
Contact Resistance: 15 milliohms max.
Dielectric Withstanding Voltage: 1500V
Insulation Resistance: 10,000 Megohms min.

Mechanical

Insertion force to PCB: 44.48N (10 lbs.)
Durability: Tin — 25 cycles; Gold — 50 cycles

Physical

Housing: Black polyester, UL 94V-0
Contact: Copper Alloy
Operating Temperature: -40 to +105°C

Circuits	Order No.			Lead-free
	Tin	15µm Gold	30µm Gold	
2	15-91-3024	15-91-2025	15-91-3023	Yes
3	15-91-3034	15-91-2035	15-91-3033	
4	15-91-3044	15-91-2045	15-91-3043	
5	15-91-3054	15-91-2055	15-91-3053	
6	15-91-3064	15-91-2065	15-91-3063	
7	15-91-3074	15-91-2075	15-91-3073	
8	15-91-3084	15-91-2085	15-91-3083	
9	15-91-3094	15-91-2095	15-91-3093	
10	15-91-3104	15-91-2105	15-91-3103	
11	15-91-3114	15-91-2115	15-91-3113	
12	15-91-3124	15-91-2125	15-91-3123	
13	15-91-3134	15-91-2135	15-91-3133	

Circuits	Order No.			Lead-free
	Tin	15µm Gold	30µm Gold	
14	15-91-3144	15-91-2145	15-91-3143	Yes
15	15-91-3154	15-91-2155	15-91-3153	
16	15-91-3164	15-91-2165	15-91-3163	
17	15-91-3174	15-91-2175	15-91-3173	
18	15-91-3184	15-91-2185	15-91-3183	
19	15-91-3194	15-91-2195	15-91-3193	
20	15-91-3204	15-91-2205	15-91-3203	
21	15-91-3214	15-91-2215	15-91-3213	
22	15-91-3224	15-91-2225	15-91-3223	
23	15-91-3234	15-91-2235	15-91-3233	
24	15-91-3244	15-91-2245	15-91-3243	
25	15-91-3254	15-91-2255	15-91-3253	

www.molex.com/product/sl_products.html

2.54mm (.100") Pitch C-Grid® Breakaway Header

70280
Dual Row, Vertical
High-Temperature

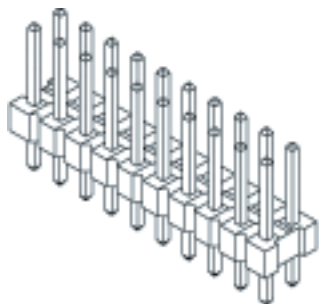

Features and Benefits

- Sizes 4 to 100 circuits
- Stackable side-to-side and end-to-end (on unbroken edges)
- Easy breakaway to smaller sizes
- Drawn .025" square wire provides 4-sided smooth surface for quality interface

Reference Information

Product Specifications: PS-70280
Packaging: Bag
UL File No.: E29179
CSA File No.: LR19980
Mates With: 7859 Shunts, C-Grid Receptacles, SL Crimp, FFC and IDT Housings
Designed In: Inches

Electrical

Voltage: 250V
Current: 3.0A
Contact Resistance: 15 milliohms max.
Dielectric Withstanding Voltage: 1500V
Insulation Resistance: 1000 Megohms min.

Mechanical

Pin Retention to Header: 17.79N (4 lb)
Durability: Tin—25 cycles; Gold—50 cycles

Physical

Housing: Black high-temperature thermal plastic, UL 94V-0
Contact: Copper Alloy
Plating: See Table
Operating Temperature: -40 to +105°C

Not For Use With Molex C-Grid III™ Components

Plating Option	Order No.	Lead-free
150µm Tin	10-89-7XX1	Yes
15µm Gold	10-89-7XX2	
30µm Gold	10-89-7XX0	

Replace XX with no. of circuits, 04-80 (even only). See sales drawing for 82-100.



2.54mm (.100") Pitch C-Grid® Breakaway Header

75102 Dual Row Vertical, CPI

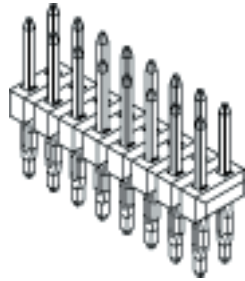

Features and Benefits

- Size 4 to 80 circuits
- Stackable side-to-side and end-to-end (on unbroken edges)
- Easy breakaway to smaller sizes
- Eye-of-the-needle compliant pin for press-fit applications

Reference Information

Product Specification: PS-75100
 Packaging: Bag
 UL File No.: E29179
 CSA File No.: LR19980
 Mates With: 7859 shunts, C-Grid receptacles, SL crimp,
 FFC and IDT housings
 Designed In: Inches

Electrical

Voltage: 250V
 Current: 3.0A
 Contact Resistance: 10 milliohms max.
 Dielectric Withstanding Voltage: 1500V
 Insulation Resistance: 1000 Megohms min.

Mechanical

Durability: Tin—25 cycles; Gold—50 cycles

Physical

Housing: Black Polyester, UL 94V-0
 Contact: Copper Alloy
 Plating: See table
 Operating Temperature: -40 to +105°C

Not For Use With C-Grid III™ Components

Circuits	Order No.			Lead-free
	Tin	15µ" Gold	30µ" Gold	
4	75102-0079	75102-0040	75102-0001	Yes
6	75102-0080	75102-0041	75102-0002	
8	75102-0081	75102-0042	75102-0003	
10	75102-0082	75102-0043	75102-0004	
12	75102-0083	75102-0044	75102-0005	
14	75102-0084	75102-0045	75102-0006	
16	75102-0085	75102-0046	75102-0007	
18	75102-0086	75102-0047	75102-0008	
20	75102-0087	75102-0048	75102-0009	
22	75102-0088	75102-0049	75102-0010	
24	75102-0089	75102-0050	75102-0011	
26	75102-0090	75102-0051	75102-0012	
28	75102-0091	75102-0052	75102-0013	
30	75102-0092	75102-0053	75102-0014	
32	75102-0093	75102-0054	75102-0015	
34	75102-0094	75102-0055	75102-0016	
36	75102-0095	75102-0056	75102-0017	
38	75102-0096	75102-0057	75102-0018	
40	75102-0097	75102-0058	75102-0019	
42	75102-0098	75102-0059	75102-0020	
44	75102-0099	75102-0060	75102-0021	
46	75102-0100	75102-0061	75102-0022	
48	75102-0101	75102-0062	75102-0023	
50	75102-0102	75102-0063	75102-0024	
52	75102-0103	75102-0064	75102-0025	
54	75102-0104	75102-0065	75102-0026	
56	75102-0105	75102-0066	75102-0027	
58	75102-0106	75102-0067	75102-0028	
60	75102-0107	75102-0068	75102-0029	
62	75102-0108	75102-0069	75102-0030	
64	75102-0109	75102-0070	75102-0031	
66	75102-0110	75102-0071	75102-0032	
68	75102-0111	75102-0072	75102-0033	
70	75102-0112	75102-0073	75102-0034	
72	75102-0113	75102-0074	75102-0035	
74	75102-0114	75102-0075	75102-0036	
76	75102-0115	75102-0076	75102-0037	
78	75102-0116	75102-0077	75102-0038	
80	75102-0117	75102-0078	75102-0039	

2.54mm (.100") Pitch C-Grid® Breakaway Header

71308

**Dual Row, SMT, Vertical
With or Without Peg**

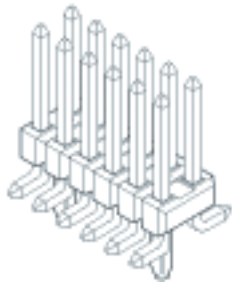

Features and Benefits

- Available with or without retention pegs
- Gull wing surface mount tails
- Vapor phase/IR reflow process compatible
- Stackable end-to-end (on unbroken edges)
- Drawn .025" square wire provides 4-sided smooth interface

Reference Information

Product Specification: PS-71308
 Packaging: Tube or tape and reel*
 UL File No.: E29179
 CSA File No.: LR19980
 Mates With: 7859 Shunts, C-Grid Receptacles, SL Crimp, FFC and IDT Housings
 Designed In: Inches

* Contact Molex for tape and reel order numbers

Electrical

Voltage: 250V
 Current: 3.0A
 Contact Resistance: 15 milliohms max.
 Dielectric Withstanding Voltage: 1500V
 Insulation Resistance: 1000 Megohms min.

Mechanical

Pin Retention to Header: 17.79N (4 lb)
 Insertion Force to PCB: 35.58N (8 lb) per peg
 Durability: Tin—25 cycles; Gold—50 cycles

Physical

Housing: Black high-temperature thermal plastic, UL 94V-0
 Contact: Copper Alloy
 Plating: See Table
 Operating Temperature: -40 to +105°C
 Screened Paste Thickness: .010 to .015"

Not For Use With Molex C-Grid III™ Components

Plating Option	Order No.		Lead-free
	Without PCB Retention Pegs	With PCB Retention Pegs	
150µ" Tin	15-91-2XX0	15-91-1XX1	Yes
15µ" Gold	15-91-0XX0	15-91-1XX2	
30µ" Gold	15-91-3XX0	15-91-1XX3	

Replace XX with no. of circuits, 04-80 (even only). See Sales drawing for 82-100.

2.54mm (.100") C-Grid® Breakaway Header

71764

**Low Profile, Dual Row
Right Angle,
High-Temperature**

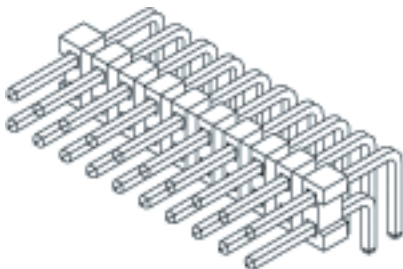

Features and Benefits

- Sizes 4 to 30 circuits
- Low profile: .200" high
- Stackable end-to-end (on unbroken edges)
- Easy breakaway to smaller sizes
- Drawn .025" square wire provides 4-sided smooth surface for quality interface
- High-temperature wafer for SMT compatibility

Reference Information

Product Specification: PS-71764
 Packaging: Tube
 UL File No.: E29179
 Mates With: 7859 Shunts, C-Grid Receptacles, SL Crimp, FFC and IDT Housings
 Designed In: Inches

Electrical

Voltage: 250V
 Current: 3.0A
 Contact Resistance: 15 milliohms max.
 Dielectric Withstanding Voltage: 1500V
 Insulation Resistance: 1000 Megohms min.

Mechanical

Pin Retention to Header: 17.79N (4 lb)
 Durability: Tin—25 cycles; Gold—50 cycles

Physical

Housing: Black high-temperature thermal plastic, UL 94V-0
 Contact: Copper Alloy
 Plating: See Table
 Operating Temperature: -40 to +105°C

Not For Use With Molex C-Grid III™ Components

Plating Option	Order No.	Lead-free
15µ" min. select Gold	71764-01XX	Yes
30µ" min. select Gold	71764-02XX	
150µ" Tin/Lead, Nickel overall	71764-00XX	

Replace XX with no. of circuits, 04-30 (even only)

2.54mm (.100") Pitch C-Grid® Breakaway Header

70216

High Profile, Dual Row Right Angle

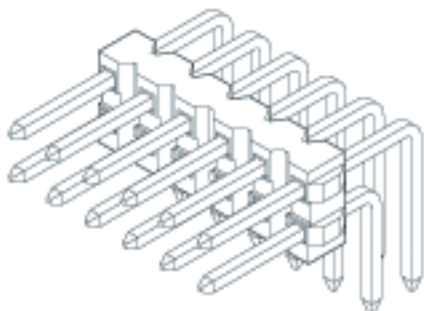

Features and Benefits

- Sizes 4 to 30 circuits
- High profile: .220" high
- Stackable end-to-end (on unbroken edges)
- Easy breakaway to smaller sizes
- Drawn .025" square wire provides 4-sided smooth surface for quality interface

Reference Information

Product Specification: PS-70216
 Packaging: Tube
 UL File No.: E29179
 CSA File No.: LR19980
 Mates With: 7859 Shunts, C-Grid Receptacles, SL Crimp, FFC and IDT Housings
 Designed In: Inches

Electrical

Voltage: 250V
 Current: 3.0A
 Contact Resistance: 15 milliohms max.
 Dielectric Withstanding Voltage: 1500V
 Insulation Resistance: 1000 Megohms min.

Mechanical

Pin Retention to Header: 17.79N (4 lb)
 Durability: Tin—25 cycles; Gold—50 cycles

Physical

Housing: Black glass-filled polyester, UL 94V-0
 Contact: Copper Alloy
 Plating: See Table
 Operating Temperature: -40 to +105°C

Not For Use With Molex C-Grid III™ Components

Plating Option	Order No.	Lead-free
150µ" Tin	10-88-3XX1	Yes
15µ" Gold	10-89-4XX2	
30µ" Gold	10-89-4XX6	
Replace XX with no. of circuits, 04-30 (even only)		

2.54mm (.100") Pitch C-Grid® Shrouded Header

8724

Dual Row Right Angle



Features and Benefits

- Polarized
- Latch window retains positive lock on 70013 after mating
- 4 wall shielding provides unmated pin protection
- Standoffs minimize flux retention
- 4-sided smooth surface pin for quality interface

Reference Information

Product Specification: PS-8723
 Packaging: Tube
 UL File No.: E29179
 Mates With: 8724 Version A—C-Grid Receptacles and 70450A crimp housing
 8724 Version B—70013A (10 to 50 circuits)
 Designed In: Inches

Electrical

Voltage: 250V
 Current: 3.0A
 Contact Resistance: 15 milliohms max.
 Dielectric Withstanding Voltage: 1500V
 Insulation Resistance: 1000 Megohms min.

Mechanical

Pin Retention to Housing: 17.79N (4 lb)
 Durability: Tin—25 cycles; Gold—50 cycles

Physical

Housing: Black nylon, UL 94V-0
 Contact: Copper Alloy
 Plating: See Table
 Operating Temperature: -40 to +105°C

Not For Use With C-Grid III™ Components

Plating Option	Order No.		Lead-free
	Version A* Pin to Side Wall Distance = 1.68mm (.066")	Version B Pin to Side Wall Distance = 3.81mm (.150")	
150µ" Tin	15-42-70XX	15-42-72XX	Yes
15µ" Gold	15-29-70XX	15-29-72XX	
30µ" Gold	15-41-80XX	15-41-82XX	
Replace XX with no. of circuits, 06-72 (even only)			

Note: No latching window available for 6-circuit and 8-circuit—Version A; No latching window available for 6-circuit—Version B
 * Version A is never to be used with interim clips

2.54mm (.100") Pitch C-Grid® Shrouded Header

70567

Dual Row, High-Temperature Through Hole without Pegs Vertical

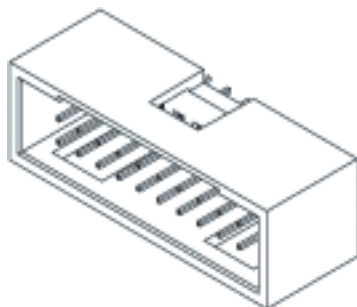

Plating Option	Order No.	Lead-free
	End Wall = 1.68mm (.066")	
15µ" min. select Gold	15-80-0XX3	Yes
30µ" min. select Gold	15-80-0XX5	
150µ" Tin/Lead	15-80-0XX1	

Replace XX with no. of circuits, 06-72 (even only)

Features and Benefits

- Sizes 6 to 72 circuits
- Robotically insertable and compatible
- Board retention pegs hold header in place until they are permanently secured by soldering
- Latch window retains modular connector assemblies after mating
- Standoffs minimize flux retention
- Drawn .025" square wire provides 4-sided smooth surface for quality interface

Reference Information

Product Specification: PS-70567

Packaging: Tube

Mates With:

Version A—C-Grid receptacles, 70450A crimp housing

Version B—70013A (10-50 circuits)

Version C—70013B (10-50 circuits)

Designed In: Inches

Electrical

Voltage: 250V

Current: 3.0A

Contact Resistance: 15 milliohms max.

Dielectric Withstanding Voltage: 1500V

Insulation Resistance: 1000 Megohms min.

Mechanical

Contact Retention to Housing: 17.79N (4 lb)

Durability: Tin—25 cycles; Gold—50 cycles

Physical

Housing: Black high-temperature thermal plastic, UL 94V-0

Contact: Copper Alloy

Plating: See Table

Operating Temperature: -40 to +105°C

2.54mm (.100") Pitch C-Grid® Shrouded Header

70568

Dual Row, High-Temperature Through Hole with Pegs Vertical

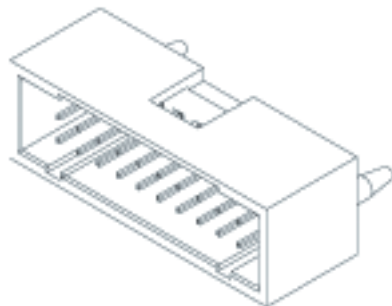

Plating Option	Order No.	Lead-free
15µ" min. select Gold	15-47-76XX	Yes
30µ" min. select Gold	15-47-77XX	
150µ" Tin/Lead	15-47-75XX	

Replace XX with no. of circuits, 06-72 (even only)

Features and Benefits

- Sizes 6 to 72 circuits
- Robotically insertable and compatible
- Board retention pegs hold header in place until they are permanently secured by soldering
- Latch window retains modular connector assemblies after mating
- Standoffs minimize flux retention
- Drawn .025" square wire provides 4-sided smooth surface for quality interface

Reference Information

Product Specification: PS-70567

Packaging: Tube

Mates With: C-Grid Receptacles, 70013B interim clip and 70450A crimp housing

Designed In: Inches

Electrical

Voltage: 250V

Current: 3.0A

Contact Resistance: 15 milliohms max.

Dielectric Withstanding Voltage: 1500V

Insulation Resistance: 1000 Megohms min.

Mechanical

Contact Retention to Housing: 17.79N (4 lb)

Durability: Tin—25 cycles; Gold—50 cycles

Physical

Housing: Black high-temperature thermal plastic, UL 94V-0

Contact: Copper Alloy

Plating: See Table

Operating Temperature: -40 to +105°C

2.54 (.100") Pitch C-Grid® Shrouded Header

71349

Dual Row, SMT Vertical, With and Without Pegs

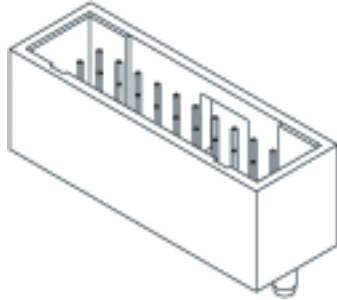

Features and Benefits

- Fully shrouded to protect pins during mating/unmating
- Polarizing slots guide front ribs of mating connector to prevent pin damage
- Latch window retains positive lock after mating
- Press-fit peg provides additional retention to PCB during soldering

Reference Information

Product Specification: PS-71349
 Packaging Type: Tube
 Mates with: C-Grid Receptacles, 70013 Version B interim clip and 70450A crimp housing
 Designed in: Inches

Electrical

Electrical Voltage: 250V
 Current: 3.0A
 Contact Resistance: 15 milliohms max.
 Dielectric Withstanding Voltage: 1500V
 Insulation Resistance: 1000 Megohms min.

Mechanical

Contact Retention to Housing: 17.79N (4 lb.)
 Durability: Tin—25 cycles; Gold—50 cycles

Physical

Physical Housing: Black high-temperature thermal plastic, UL 94V-0
 Contact: Copper Alloy
 Plating: See Table
 Operating Temperature: -40 to +105°C

Circuits	Order No.			Lead-free
	150µm Tin	15µm Gold	30µm Gold	
6	71349-X001	71349-X035	71349-X069	Yes
8	71349-X002	71349-X036	71349-X070	
10	71349-X003	71349-X037	71349-X071	
12	71349-X004	71349-X038	71349-X072	
14	71349-X005	71349-X039	71349-X073	
16	71349-X006	71349-X040	71349-X074	
18	71349-X007	71349-X041	71349-X075	
20	71349-X008	71349-X042	71349-X076	
22	71349-X009	71349-X043	71349-X077	
24	71349-X010	71349-X044	71349-X078	
26	71349-X011	71349-X045	71349-X079	
28	71349-X012	71349-X046	71349-X080	
30	71349-X013	71349-X047	71349-X081	
32	71349-X014	71349-X048	71349-X082	
34	71349-X015	71349-X049	71349-X083	
36	71349-X016	71349-X050	71349-X084	
38	71349-X017	71349-X051	71349-X085	
40	71349-X018	71349-X052	71349-X086	

Circuits	Order No.			Lead-free
	150µm Tin	15µm Gold	30µm Gold	
42	71349-X019	71349-X053	71349-X087	Yes
44	71349-X020	71349-X054	71349-X088	
46	71349-X021	71349-X055	71349-X089	
48	71349-X022	71349-X056	71349-X090	
50	71349-X023	71349-X057	71349-X091	
52	71349-X024	71349-X058	71349-X092	
54	71349-X025	71349-X059	71349-X093	
56	71349-X026	71349-X060	71349-X094	
58	71349-X027	71349-X061	71349-X095	
60	71349-X028	71349-X062	71349-X096	
62	71349-X029	71349-X063	71349-X097	
64	71349-X030	71349-X064	71349-X098	
66	71349-X031	71349-X065	71349-X099	
68	71349-X032	71349-X066	71349-X100	
70	71349-X033	71349-X067	71349-X101	
72	71349-X034	71349-X068	71349-X102	

Replace X with 1 for no peg version, 2 for peg version

2.54mm (.100") Pitch C-Grid® Shrouded Header

70229

**Dual Row, Right Angle
With Retention Pegs**

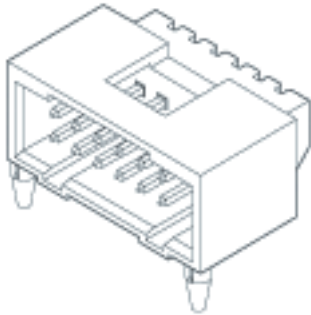

Not For Use With C-Grid III™ Components

Circuits	Order No.		Lead-free
	150µm Tin	15µm Gold	
6	15-47-1061	15-47-6061	Yes
8	15-47-1081	15-47-6081	
10	15-47-1101	15-47-6101	
12	15-47-1121	15-47-6121	
14	15-47-1141	15-47-6141	
16	15-47-1161	15-47-6161	
18	15-47-1181	15-47-6181	
20	15-47-1201	15-47-6201	
22	15-47-1221	15-47-6221	
24	15-47-1241	15-47-6241	
26	15-47-1261	15-47-6261	
28	15-47-1281	15-47-6281	

Features and Benefits

- Sizes 6 to 72 circuits
- Board retention pegs hold header in place until they are permanently secured by soldering
- Latch window retains positive lock on 70013 after mating

Reference Information

Product Specification: PS-70227
 Packaging: Tube
 UL File No.: E29179
 Mates With: C-Grid Receptacles, 70013 version B
 interim clip and 70450A crimp housing
 Designed In: Inches

Electrical

Voltage: 250V
 Current: 3.0A
 Contact Resistance: 15 milliohms max.
 Dielectric Withstanding Voltage: 1500V
 Insulation Resistance: 1000 Megohms min.

Mechanical

Pin Retention to Housing: 17.79N (4 lb)
 Durability: Tin—25 cycles; Gold—50 cycles

Physical

Housing: Black polyester, UL 94V-0
 Contact: Copper Alloy
 Plating: See Table
 Operating Temperature: -40 to +105°C

Circuits	Order No.		Lead-free
	150µm Tin	15µm Gold	
30	15-47-1301	15-47-6301	Yes
32	15-47-1321	15-47-6321	
34	15-47-1341	15-47-6341	
36	15-47-1361	15-47-6361	
38	15-47-1381	15-47-6381	
40	15-47-1401	15-47-6401	
42	15-47-1421	15-47-6421	
44	15-47-1441	15-47-6441	
46	15-47-1461	15-47-6461	
48	15-47-1481	15-47-6481	
50	15-47-1501	15-47-6501	
52	15-47-1521	15-47-6521	

Circuits	Order No.		Lead-free
	150µm Tin	15µm Gold	
54	15-47-1541	15-47-6541	Yes
56	15-47-1561	15-47-6561	
58	15-47-1581	15-47-6581	
60	15-47-1601	15-47-6601	
62	15-47-1621	15-47-6621	
64	15-47-1641	15-47-6641	
66	15-47-1661	15-47-6661	
68	15-47-1681	15-47-6681	
70	15-47-1701	15-47-6701	
72	15-47-1721	15-47-6721	

2.54mm (.100") Pitch C-Grid® Shrouded Header

70204

**Dual Row
With PC Slot and Guide Ears**

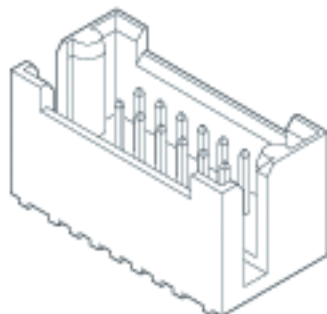

Not For Use With C-Grid III™ Components

Plating Options	Order No.	Lead-free
150µm Tin	25-02-20XX	Yes
15µm Gold	25-02-60XX	
30µm Gold	25-02-10XX	

Replace XX with no. of circuits, 08-72 (even only)
 Example: 20 circuit = 25-02-6020

Features and Benefits

- With PC slot and guide ears for blind-mate applications
- Polarization slots and guide ears assure error free mating
- Drawn .025" square wire provides 4-sided smooth surface for quality interface

Reference Information

Product Specification: PS-70204
 Packaging: Tray
 UL File No.: E29179
 CSA File No.: LR19980
 Mates With: 71973 with flange
 Designed In: Inches

Electrical

Voltage: 250V
 Current: 3.0A
 Contact Resistance: 15 milliohms max.
 Dielectric Withstanding Voltage: 1500V
 Insulation Resistance: 1000 Megohms min.

Mechanical

Contact Retention to Housing: 17.79N (4 lb)
 Durability: Tin—25 cycles; Gold—50 cycles

Physical

Housing: Black nylon, UL 94V-0
 Contact: Copper Alloy
 Plating: See Table
 Operating Temperature: -40 to +105°C

2.54mm (.100") Pitch C-Grid® Shrouded Header

75100

**Dual Row
With PC Slot and Guide Ears, CPI**

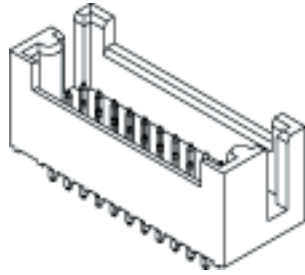

Features and Benefits

- Size 8 to 130 circuits
- With PC slot and guide ears for blind-mate applications
- Polarization slots and guide ears assure error-free mating
- Eye-of-the-needle compliant pin for press-fit applications

Reference Information

Product Specification: PS-75100
 Packaging: Tray
 UL File No.: E29179
 CSA File No.: LR19980
 Mates with: 71973 with flange
 Designed In: Inches

Electrical

Voltage: 250V
 Current: 3.0A
 Contact Resistance: 10 milliohms max.
 Dielectric Withstanding Voltage: 1500V
 Insulation Resistance: 1000 Megohms min.

Mechanical

Durability: Tin—25 cycles; Gold—50 cycles

Physical

Housing: Black nylon, UL 94V-0
 Contact: Copper Alloy
 Plating: See table
 Operating Temperature: -40 to +105°C

2.54mm (.100") Pitch PCB and Wire Connectors

Circuit Size	Tin	15µ" Gold	30µ" Gold	Lead-free
4	75100-0129	75100-0065	75100-0001	Yes
6	75100-0130	75100-0066	75100-0002	
8	75100-0131	75100-0067	75100-0003	
10	75100-0132	75100-0068	75100-0004	
12	75100-0133	75100-0069	75100-0005	
14	75100-0134	75100-0070	75100-0006	
16	75100-0135	75100-0071	75100-0007	
18	75100-0136	75100-0072	75100-0008	
20	75100-0137	75100-0073	75100-0009	
22	75100-0138	75100-0074	75100-0010	
24	75100-0139	75100-0075	75100-0011	
26	75100-0140	75100-0076	75100-0012	
28	75100-0141	75100-0077	75100-0013	
30	75100-0142	75100-0078	75100-0014	
32	75100-0143	75100-0079	75100-0015	
34	75100-0144	75100-0080	75100-0016	
36	75100-0145	75100-0081	75100-0017	
38	75100-0146	75100-0082	75100-0018	
40	75100-0147	75100-0083	75100-0019	
42	75100-0148	75100-0084	75100-0020	
44	75100-0149	75100-0085	75100-0021	
46	75100-0150	75100-0086	75100-0022	
48	75100-0151	75100-0087	75100-0023	
50	75100-0152	75100-0088	75100-0024	
52	75100-0153	75100-0089	75100-0025	
54	75100-0154	75100-0090	75100-0026	
56	75100-0155	75100-0091	75100-0027	
58	75100-0156	75100-0092	75100-0028	
60	75100-0157	75100-0093	75100-0029	
62	75100-0158	75100-0094	75100-0030	
64	75100-0159	75100-0095	75100-0031	
66	75100-0160	75100-0096	75100-0032	
68	75100-0161	75100-0097	75100-0033	
70	75100-0162	75100-0098	75100-0034	
72	75100-0163	75100-0099	75100-0035	

2.54mm (.100") Pitch C-Grid® Shrouded Header

75101 Dual Row With PC Slot and Guide Ears, CPI

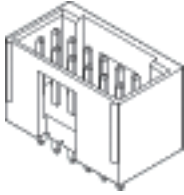

Features and Benefits

- Polarized
- Latching window retains positive lock on 70013 after mating
- Shrouded housing provides unmated pin protection
- Eye-of-the-needle compliant pin for press-fit applications

Reference Information

Product Specification: PS-75100
 Packaging: Tray
 UL File No.: E29179
 CSA File No.: LR19980
 Mates With: 8723 Version A—C-Grid receptacles,
 and 70450A crimp housing
 8723 Version B—70013A (10 to 50 circuits)
 Designed In: Inches

Electrical

Voltage: 250V
 Current: 3.0A
 Contact Resistance: 10 milliohms max.
 Dielectric Withstanding Voltage: 1500V
 Insulation Resistance: 1000 Megohms min.

Mechanical

Durability: Tin—25 cycles; Gold—50 cycles

Physical

Housing: Black Nylon, UL 94V-0
 Contact: Copper Alloy
 Plating: See table
 Operating Temperature: -40 to 105°C

Circuits	Version A			Version B			Lead-free
	Tin	15µ" Gold	30µ" Gold	Tin	15µ" Gold	30µ" Gold	
6	75101-0171	75101-0137	75101-0001	75101-0239	75101-0205	75101-0035	Yes
8	75101-0172	75101-0138	75101-0002	75101-0240	75101-0206	75101-0036	
10	75101-0173	75101-0139	75101-0003	75101-0241	75101-0207	75101-0037	
12	75101-0174	75101-0140	75101-0004	75101-0242	75101-0208	75101-0038	
14	75101-0175	75101-0141	75101-0005	75101-0243	75101-0209	75101-0039	
16	75101-0176	75101-0142	75101-0006	75101-0244	75101-0210	75101-0040	
18	75101-0177	75101-0143	75101-0007	75101-0245	75101-0211	75101-0041	
20	75101-0178	75101-0144	75101-0008	75101-0246	75101-0212	75101-0042	
22	75101-0179	75101-0145	75101-0009	75101-0247	75101-0213	75101-0043	
24	75101-0180	75101-0146	75101-0010	75101-0248	75101-0214	75101-0044	
26	75101-0181	75101-0147	75101-0011	75101-0249	75101-0215	75101-0045	
28	75101-0182	75101-0148	75101-0012	75101-0250	75101-0216	75101-0046	
30	75101-0183	75101-0149	75101-0013	75101-0251	75101-0217	75101-0047	
32	75101-0184	75101-0150	75101-0014	75101-0252	75101-0218	75101-0048	
34	75101-0185	75101-0151	75101-0015	75101-0253	75101-0219	75101-0049	
36	75101-0186	75101-0152	75101-0016	75101-0254	75101-0220	75101-0050	
38	75101-0187	75101-0153	75101-0017	75101-0255	75101-0221	75101-0051	
40	75101-0188	75101-0154	75101-0018	75101-0256	75101-0222	75101-0052	
42	75101-0189	75101-0155	75101-0019	75101-0257	75101-0223	75101-0053	
44	75101-0194	75101-0156	75101-0020	75101-0258	75101-0224	75101-0054	
46	75101-0195	75101-0157	75101-0021	75101-0259	75101-0225	75101-0055	
48	75101-0196	75101-0158	75101-0022	75101-0260	75101-0226	75101-0056	
50	75101-0197	75101-0159	75101-0023	75101-0261	75101-0227	75101-0057	
52	75101-0198	75101-0160	75101-0024	75101-0262	75101-0228	75101-0058	
54	75101-0199	75101-0161	75101-0025	75101-0263	75101-0229	75101-0059	
56	75101-0200	75101-0162	75101-0026	75101-0264	75101-0230	75101-0060	
58	75101-0201	75101-0163	75101-0027	75101-0265	75101-0231	75101-0061	
60	75101-0202	75101-0164	75101-0028	75101-0266	75101-0232	75101-0062	
62	75101-0203	75101-0165	75101-0029	75101-0267	75101-0233	75101-0063	
64	75101-0204	75101-0166	75101-0030	75101-0268	75101-0234	75101-0064	
66	75101-0201	75101-0167	75101-0031	75101-0269	75101-0235	75101-0065	
68	75101-0202	75101-0168	75101-0032	75101-0270	75101-0236	75101-0066	
70	75101-0203	75101-0169	75101-0033	75101-0271	75101-0237	75101-0067	
72	75101-0204	75101-0170	75101-0034	75101-0272	75101-0238	75101-0068	

2.54mm (.100") Pitch C-Grid® Shrouded Header

87834

Dual Row, Low Profile, Vertical

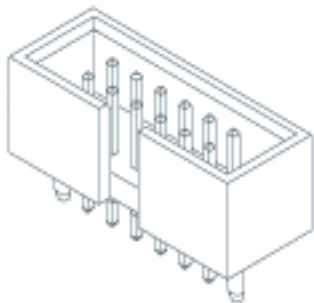

Features and Benefits

- Sizes 4 to 50 circuits
- Low profile
- Polarized slot
- Fully shrouded to protect pins during mating
- In-line or alternate polarization pegs options

Reference Information

Product Specification: PS-70246-100
Mates With: .050" pitch ribbon cable connectors
Designed In: Inches

Electrical

Voltage: 250V AC max.
Current: 2.5A
Dielectric Withstanding Voltage: 600V AC/1 min.
Insulation Resistance: 12,000 Megohms min.

Mechanical

Contact Retention: 0.907kg (2 lb) min.
Pin Push-Out Force: 0.907kg (2 lb) min.

Physical

Housing: Beige glass-filled 4/6 nylon, UL 94V-0
Contact: Copper Alloy
Plating: Gold on contacts and Tin on solder tails
Operating Temperature: -55 to +120°C

Circuits	Order No.	Lead-free
4	87834-0411	Yes
6	87834-0611	
8	87834-0811	
10	87834-1011	
12	87834-1211	
14	87834-1411	
16	87834-1611	
18	87834-1811	

Circuits	Order No.	Lead-free
20	87834-2011	Yes
24	87834-2411	
26	87834-2611	
30	87834-3011	
34	87834-3411	
40	87834-4011	
44	87834-4411	
50	87834-5011	

2.54mm (.100") Pitch C-Grid® Shrouded Header

70246

Dual Row, Low Profile, Vertical

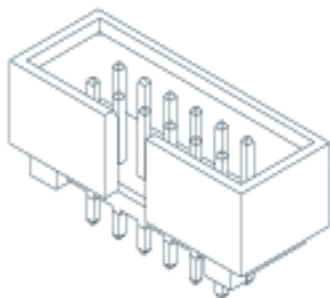

Features and Benefits

- Sizes 8 to 64 circuits
- Polarized slot
- Low profile
- High temperature material version available, contact Molex

Reference Information

Product Specification: PS-70246-100
UL File No.: E29179 (H)
CSA File No.: LR19980A
Mates With: .050" pitch ribbon cable connectors
Designed In: Inches

Electrical

Voltage: 250V
Current: 2.5A DC min.
Contact Resistance: 15 milliohms max.
Dielectric Withstanding Voltage: 1500V
Insulation Resistance: 1000 Megohms min.

Mechanical

Contact Retention to Housing: 17.79N (4 lb)
Durability: 50 cycles Gold

Physical

Housing: Black PBT, UL 94V-0
Contact: Phosphor Bronze
Plating: See Table
Operating Temperature: -55 to +120°C

Not For Use With C-Grid III™ Components

Circuits	Order No.		Lead-free
	15µ" Gold	30µ" Gold	
8	70246-0801	70246-0802	Yes
10	70246-1001	70246-1002	
12	70246-1201	70246-1202	
14	70246-1401	70246-1402	
16	70246-1601	70246-1602	
20	70246-2001	70246-2002	
24	70246-2401	70246-2402	
26	70246-2601	70246-2602	

Circuits	Order No.		Lead-free
	15µ" Gold	30µ" Gold	
30	70246-3001	70246-3002	Yes
34	70246-3401	70246-3402	
40	70246-4001	70246-4002	
44	70246-4401	70246-4402	
50	70246-5001	70246-5002	
56	70246-5601	70246-5602	
60	70246-6001	70246-6002	
64	70246-6401	70246-6402	

2.54mm (.100") Pitch C-Grid® Shrouded Header

70247

**Dual Row, Low Profile
Right Angle**

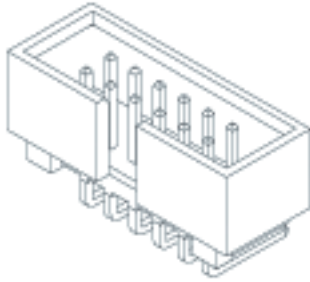

Features and Benefits

- Sizes 8 to 64 circuits
- Polarized slot
- Low profile
- High temperature material version available, contact Molex

Reference Information

Product Specification: PS-70246-100
 UL File No.: E29179 (H)
 CSA File No.: LR19980A
 Mates With: .050" pitch ribbon cable connectors
 Designed In: Inches

Electrical

Voltage: 250V
 Current: 2.5A DC min.
 Contact Resistance: 15 milliohms max.
 Dielectric Withstanding Voltage: 600V
 Insulation Resistance: 1000 Megohms min.

Mechanical

Contact Retention to Housing: 1.8kg (4 lb)
 Durability: 50 cycles Gold

Physical

Housing: Black glass-filled PBT, UL 94V-0
 Contact: Phosphor Bronze
 Plating: See Table
 Operating Temperature: -55 to +120° C

Not For Use With C-Grid III™ Components

Circuits	Order No.		Lead-fee
	15µ" Gold	30µ" Gold	
8	70247-0851	70247-0852	Yes
10	70247-1051	70247-1052	
12	70247-1251	70247-1252	
14	70247-1451	70247-1452	
16	70247-1651	70247-1652	
20	70247-2051	70247-2052	
24	70247-2451	70247-2452	
26	70247-2651	70247-2652	
30	70247-3051	70247-3052	

Circuits	Order No.		Lead-fee
	15µ" Gold	30µ" Gold	
34	70247-3451	70247-3452	Yes
40	70247-4051	70247-4052	
44	70247-4451	70247-4452	
48	70247-4851	70247-4852	
50	70247-5051	70247-5052	
56	70247-5651	70247-5652	
60	70247-6051	70247-6052	
64	70247-6451	70247-6452	
72	70247-7251	70247-7252	

2.54mm (.100") Pitch C-Grid® PC Board Connectors

90147 Single Row Vertical

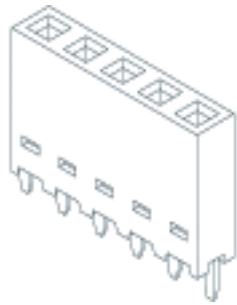

Features and Benefits

- Sizes 2 to 32 circuits
- Contact and plating orientation according to DIN 41651
- Stackable in 2 directions
- Meets HE 13/14 specification
- Suitable for single row headers

Reference Information

Product Specification: PS-99020-0001
 Packaging: Tube
 UL File No.: E29179
 CSA File No.: LR19980
 Mates With: 0.64mm (.025") square pins
 Use With: 1.57mm (.062") thick PC boards
 Designed In: Inches

Electrical

Voltage: 350V
 Current: 3.0A
 Contact Resistance: 20 milliohms max.
 Insulation Resistance: 1000 Megohms min.

Mechanical

Contact Retention to Housing: 15N min.
 Mating Force: 1N Gold max. and 3N Tin max.
 Unmating Force: 0.2N Gold min. and 0.2N Tin min.
 Normal Force: 1N

Physical

Housing: Black glass-filled polyester, UL 94V-0
 Contact: Copper Alloy
 Plating: See Table
 Operating Temperature: -55 to +125°C
 Recommended Mating Pin Length:
 5.65mm (.222") min. to 7.00mm (.275") max.

2.54mm (.100") Pitch PCB and Wire Connectors

Circuits	Order No.						Lead-free
	Straight Tail			Kinked Tail			
	Plating A	Plating E	Plating F	Plating A	Plating E	Plating F	
2	90147-1102	90147-1202	90147-1302				Yes
3	90147-1103	90147-1203	90147-1303	90147-2103	90147-2203	90147-2303	
4	90147-1104	90147-1204	90147-1304	90147-2104	90147-2204	90147-2304	
5	90147-1105	90147-1205	90147-1305	90147-2105	90147-2205	90147-2305	
6	90147-1106	90147-1206	90147-1306	90147-2106	90147-2206	90147-2306	
7	90147-1107	90147-1207	90147-1307	90147-2107	90147-2207	90147-2307	
8	90147-1108	90147-1208	90147-1308	90147-2108	90147-2208	90147-2308	
9	90147-1109	90147-1209	90147-1309	90147-2109	90147-2209	90147-2309	
10	90147-1110	90147-1210	90147-1310	90147-2110	90147-2210	90147-2310	
11	90147-1111	90147-1211	90147-1311	90147-2111	90147-2211	90147-2311	
12	90147-1112	90147-1212	90147-1312	90147-2112	90147-2212	90147-2312	
14	90147-1114	90147-1214	90147-1314	90147-2114	90147-2214	90147-2314	
18	90147-1118	90147-1218	90147-1318	90147-2118	90147-2218	90147-2318	
25	90147-1125	90147-1225	90147-1325	90147-2125	90147-2225	90147-2325	
30	90147-1130	90147-1230	90147-1330	90147-2130	90147-2230	90147-2330	
32	90147-1132	90147-1232	90147-1332	90147-2132	90147-2232	90147-2332	

For other available circuit sizes contact Molex

Plating A: 1.00µm (39µ") min. Hot Tin dip

Plating E: 0.38mm (15µ") selective Gold over Nickel and 4µm (160µ") Tin over Nickel

Plating F: 0.76mm (30µ") selective Gold over Nickel and 4µm (160µ") Tin over Nickel

2.54mm (.100") Pitch C-Grid® PC Board Connectors

90148 Single Row Horizontal

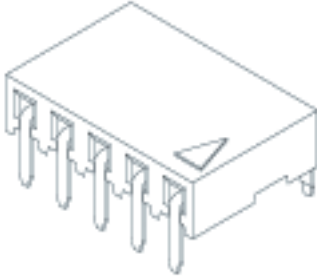

Features and Benefits

- Sizes 2 to 32 circuits
- Contact and plating orientation according to DIN 41651
- Stackable end-to-end
- Meets HE 13/14 specification
- Suitable for single row headers

Reference Information

Product Specification: PS-99020-0001
Packaging: Tube
UL File No.: E29179
CSA File No.: LR19980
Mates With: 0.64 (.025") square pins
Use With: 1.57mm (.062") thick PC boards
Designed In: Inches

Electrical

Voltage: 350V
Current: 3.0A
Contact Resistance: 20 milliohms max.
Insulation Resistance: 1000 Megohms min.

Mechanical

Contact Retention to Housing: 15N min.
Mating Force: 1N Gold max. and 3N Tin max.
Unmating Force: 0.2N Gold min. and 0.2N Tin min.
Normal Force: 1N

Physical

Housing: Black glass-filled polyester, UL 94V-0
Contact: Copper Alloy
Plating: See Table
Operating Temperature: -55 to +125°C
Recommended Mating Pin Length:
5.65mm (.222") min. to 7.00mm (.275") max.

Circuits	Order No.			Lead-free
	Straight Tail			
	Plating A	Plating E	Plating F	
2	90148-1102	90148-1202	90148-1302	Yes
4	90148-1104	90148-1204	90148-1304	
6	90148-1106	90148-1206	90148-1306	
8	90148-1108	90148-1208	90148-1308	
10	90148-1110	90148-1210	90148-1310	

Circuits	Order No.			Lead-free
	Straight Tail			
	Plating A	Plating E	Plating F	
12	90148-1112	90148-1212	90148-1312	Yes
14	90148-1114	90148-1214	90148-1314	
18	90148-1118	90148-1218	90148-1318	
30	90148-1130	90148-1230	90148-1330	
32	90148-1132	90148-1232	90148-1332	

For other available circuit sizes contact Molex
Plating A: 1.00mm (39µm) min. Hot Tin dip
Plating E: 0.38mm (15µm) selective Gold over Nickel and 4mm (160µm) Tin over Nickel
Plating F: 0.76mm (30µm) selective Gold over Nickel and 4mm (160µm) Tin over Nickel

2.54mm (.100") Pitch C-Grid® Receptacle

71850 High Profile, Dual Row High-Temperature, Vertical Through Hole

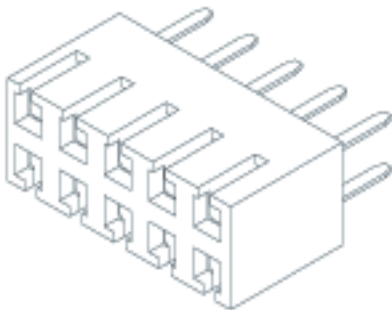

Features and Benefits

- Sizes 4 to 80 circuits
- Available with or without retention pegs
- High profile: .340" high
- Designed for parallel and perpendicular board stacking
- Stackable end-to-end on .100" grid

Reference Information

Product Specification: PS-71840
Packaging: Tray
UL File No.: E29179
CSA File No.: LR19980
Mates With: C-Grid breakaway and shrouded headers
Designed In: Inches

Electrical

Voltage: 250V
Current: 2.5A
Contact Resistance: 15 milliohms max.
Dielectric Withstanding Voltage: 1500V
Insulation Resistance: 1000 Megohms min.

Mechanical

Contact Insertion Force: 182g (0.4 lb)
Insertion Force to PCB: 3.6kg (8 lb) per peg
Durability: Tin—25 cycles; Gold—50 cycles

Physical

Housing: Black high-temperature thermal plastic, UL 94V-0
Contact: Copper Alloy
Plating: See Table
Operating Temperature: -40 to +105°C

Plating Option	Order No.	Lead-free
150µm Tin	15-44-68XX	Yes
15µm Gold	15-44-58XX	
30µm Gold	15-44-51XX	
Replace XX with no. of circuits, 04-80 (even only) Example: 20 circuit = 15-44-5820		

2.54mm (.100") Pitch C-Grid® PCB Connector

71395

High Profile, Dual Row Vertical, SMT

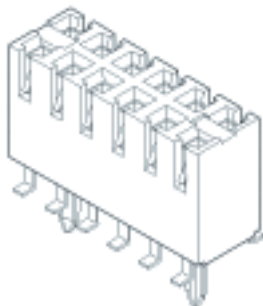

Features and Benefits

- Available with or without retention pegs
- Gull wing surface mount tails
- High profile: .340" high
- Designed for parallel and perpendicular board stacking
- Stackable end-to-end on .100" grid

Reference Information

Product Specification: PS-71395
Packaging: Tray
UL File No.: E29179
Mates With: C-Grid breakaway and shrouded headers
Designed In: Inches

Electrical

Voltage: 250V
Current: 2.5A
Contact Resistance: 15 milliohms max.
Dielectric Withstanding Voltage: 1500V
Insulation Resistance: 1000 Megohms min.

Mechanical

Insertion Force to PCB: 3.6kg (8 lb) per peg
Durability: Tin—25 cycles; Gold—50 cycles

Physical

Housing: Black high-temperature thermal plastic, UL 94V-0
Contact: Copper Alloy
Plating: See Table
Operating Temperature: -40 to +105°C
Screened Paste Thickness: .010 to .015"

Not For Use With Molex C-Grid III™ Components

Plating Option	Order No.		Lead-free
	With PCB Retention Pegs	Without Pegs	
150µm min. Tin	15-45-34XX	15-45-32XX	Yes
15µm Gold	15-45-35XX	15-45-31XX	
30µm min. Gold	15-45-36XX	15-45-33XX	
Replace XX with no. of circuits, 08-80 (even only) Example: 20 circuit = 15-45-3520			

2.54mm (.100") Pitch C-Grid® Receptacle

71979

Dual Row, Right Angle SMT

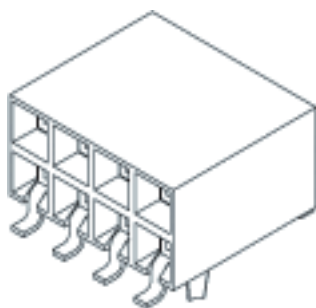

Features and Benefits

- Designed for perpendicular board stacking
- Dual beam box contact
- Staggered mating depth to lower initial insertion force
- Positive pin stop to prevent shorting between rows
- Available without pegs

Reference Information

Product Specification: PS-71973
Packaging: Tube
UL File No.: E29179
Mates With: C-Grid breakaway headers
Designed In: Inches

Electrical

Voltage: 250V
Current: 2.0A
Contact Resistance: 15 milliohms max.
Dielectric Withstanding Voltage: 1500V
Insulation Resistance: 1000 Megohms min

Mechanical

Mating Force: 1.33N (0.3 lb)
Durability: 50 cycles

Physical

Housing: Black high-temperature thermal plastic, UL 94V-0
Contact: Copper Alloy
Plating: See Table
Operating Temperature: -40 to +105°C

Not For Use With Molex C-Grid III™ Components

Plating Options	Order No.	Lead-free
15µm Gold	71979-02XX	Yes
30µm Gold	71979-03XX	
50µm Gold	71979-04XX	
Replace XX with no. of circuits per row, 08-80 Example: 20 circuit = 71979-0220		

2.54mm (.100") Pitch C-Grid® PCB Connector

71973

**Dual Row, Right Angle
Early Entry Receptacle
Flangeless**

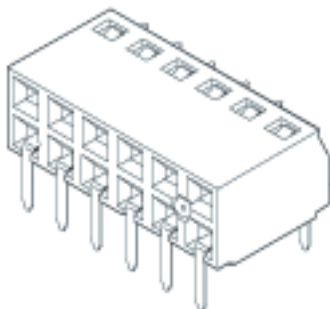

Features and Benefits

- Early entry contact provides .040" additional gold wipe on male post
- Designed for perpendicular board stacking
- Stackable end-to-end
- Flangeless with lower row pin stop offered, contact Molex
- Closed bottom insulator to prevent solder wicking

Reference Information

Product Specification: PS-71973
Packaging: Tube
UL File No.: E29179
Mates With: C-Grid breakaway headers
Designed In: Inches

Electrical

Voltage: 250V
Current: 2.0A
Contact Resistance: 15 milliohms max.
Dielectric Withstanding Voltage: 1500V
Insulation Resistance: 1000 Megohms min.

Mechanical

Mating Force: 1.33N (0.3 lb)
Durability: 50 cycles

Physical

Housing: Black high-temperature thermal plastic, UL 94V-0
Contact: Copper Alloy
Plating: See Table
Operating Temperature: -40 to +105°C

Not For Use With Molex C-Grid III™ Components

Plating Options	Order No.	Lead-free
15µ" Gold	71973-02XX	Yes
30µ" Gold	71973-03XX	
50µ" Gold	71973-04XX	
Replace XX with no. of circuits per row, 04-40 Example: 20 circuit = 71973-0220		

2.54mm (.100") Pitch C-Grid® PCB Connector

71973

**Dual Row, Right Angle
Early Entry Receptacle
With Flange**

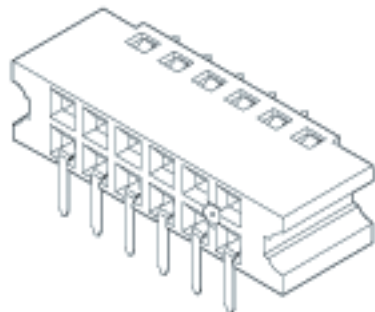

Features and Benefits

- Early entry contact provides .040" additional gold wipe on male post
- Designed for perpendicular board stacking
- Lower row pin stop offered, contact Molex
- Closed bottom insulator to prevent solder wicking
- Flange slides over guide ears on header for blind mate applications

Reference Information

Product Specification: PS-71973
Packaging: Tube
UL File No.: E29179
Mates With: 70204
Designed In: Inches

Electrical

Voltage: 250V
Current: 2.0A
Contact Resistance: 15 milliohms max.
Dielectric Withstanding Voltage: 1500V
Insulation Resistance: 1000 Megohms min.

Mechanical

Mating Force: 1.33N (0.3 lb)
Durability: 50 cycles

Physical

Housing: Black high-temperature thermal plastic, UL 94V-0
Contact: Copper Alloy
Plating: See Table
Operating Temperature: -40 to +105°C

Not For Use With Molex C-Grid III™ Components

Plating Options	Order No.	Lead-free
15µ" Gold	71973-10XX	Yes
30µ" Gold	71973-11XX	
50µ" Gold	71973-12XX	
Replace XX with no. of circuits per row, 04-36 Example: 20 circuit = 71973-1220		

2.54mm (.100") Pitch C-Grid® Shunt/Jumper

7859
2-Circuit

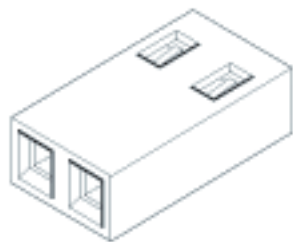

Features and Benefits

- Easily applied without soldering and reliable without accidental disconnects
- Low cost alternative to DIP switches
- Increases current flow and decreases resistance vs DIP switches
- Dual beam terminals: 2 points of contact per pin
- Open and closed top versions
- Stackable end-to-end and side-to-side

Reference Information

Product Specification: PS-7859
Packaging: Bag
UL File No.: E29179
CSA File No.: LR19980
Mates With: C-Grid breakaway headers
Designed In: Inches

Electrical

Voltage: 250V
Current: 5.0A
Contact Resistance: 30 milliohms max.
Dielectric Withstanding Voltage: 1500V
Insulation Resistance: 100K Megohms min.

Mechanical

Contact Retention to Housing: 26.69N (4 lb)
Mating Force: 4.448N (6 lb)
Unmating Force: 0.98N (1 lb)
Durability: Tin—25 cycles; Gold—200 cycles

Physical

Housing: Black polyester, UL 94V-0
Contact: Copper Alloy
Plating: See Table
Operating Temperature: -40 to +105°C

Not For Use With Molex C-Grid III™ Components

Open Top		
Order No.	Plating	Lead-free
15-38-1024	150µm Tin	Yes
15-29-1024	15µm Gold	
15-29-1026	30µm Gold	

Closed Top		
Order No.	Plating	Lead-free
15-38-1026	150µm Tin	Yes
15-29-1025	15µm Gold	
15-29-1027	30µm Gold	

2.54mm (.100") Pitch C-Grid® Micro Shunt

90059
Low Profile

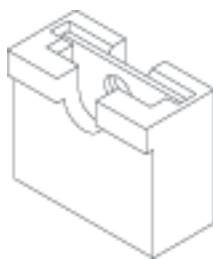

Features and Benefits

- Fully stackable
- Center probe hole—for continuity testing and easy pull-off
- Color-coded housings for plating and identification
- Delivered on break-off carrier strips for easy handling (10 per strip) or loose
- Recommended to be applied after mating header is soldered

Reference Information

Product Specification: PS-90059
Packaging: Strips or Bag
UL File No.: E29179
CSA File No.: LR19980
Designed In: Inches

Electrical

Voltage: 350V
Current: 3.0A Gold; 1.5A Tin
Contact Resistance: Gold—12 milliohms max.;
Tin—15 milliohms max.
Dielectric Withstanding Voltage: 2000V
Insulation Resistance: 2000 Megohms max.

Mechanical

Mating Force: 7N max.
Unmating Force: 0.3N Gold; 0.5N Tin min.
Durability: 50 cycles Gold and 20 cycles Tin

Physical

Housing: Glass-filled polyester, UL 94V-0
Contact: Phosphor Bronze
Plating: See Table
Operating Temperature: -55 to +125°C
Height: 4.95mm (.195") max.

Order No.	Plating No.	Color	Packaging	Lead-free
90059-0009*	1	White	Strip	Yes
90059-0007*	2	Black		
90059-0013	3			
90059-0014	4	White		
90059-0012	5	White		
90059-1009	1		Black	
90059-1007	2	Black	Bag	

* Preferred Version In Europe/Americas

Plating No. 1: 0.38µm (15µ") Gold in contact area over 0.76µm (30µ") Nickel with Gold flash overall

Plating No. 2: 5.0µm (200µ") min. Tin over 0.2µm (8µ") min. Copper

Plating No. 3: 0.9µm (35µ") min. Pretinned

Plating No. 4: 0.1µm (4µ") min. Gold over 1.0µm (40µ") min. Nickel overall

Plating No. 5: 0.76µm (30µ") Gold over 1.27µm (50µ") Nickel in contact area with 0.2mm (8µ") min. Nickel overall

2.54mm (.100") Pitch C-Grid III™

The C-Grid III 2.54mm (.100") pitch post and receptacle interconnection system offers complete design flexibility and modular components that provide the widest range of electronic packaging alternatives. C-Grid III is a highly-versatile 2.54mm interconnection system offering unique design features:

Surface Treatment

C-Grid III is available in 3 standard platings. Two performance levels of selective Gold and one of Tin, all over a Nickel-plated substrate, guarantee the optimum ratio of quality versus cost for your application.

Flexibility

C-Grid III has been developed to meet the latest industry requirements. Two different termination techniques, solder tail, crimp and insulation displacement, are combined in a complete interconnection system which is based on north/south contact orientation. Headers will accept both discrete wire and ribbon cable connectors.

Advantage by Design

C-Grid III box contact design employs the same mating concept with all termination techniques. A uniform locking system on all contacts allows full interchangeability inside different housing styles.

Interchangeability

C-Grid III is fully compatible with the industry standard DIN 41651 as well as the French norm HE-13/14. Moreover, it is fully intermateable/interchangeable with Molex's QF-50 product range.

Lower Applied Cost

C-Grid III system incorporates a wide range of advanced application tooling, from manually-operated hand tools to semi-automatic harness making machines.

C-Grid III offers the widest range of interconnection packaging alternatives in the electronic market today.

C

2.54mm (.100") Pitch PCB and Wire Connectors

Not For Use With Molex SL™ Components

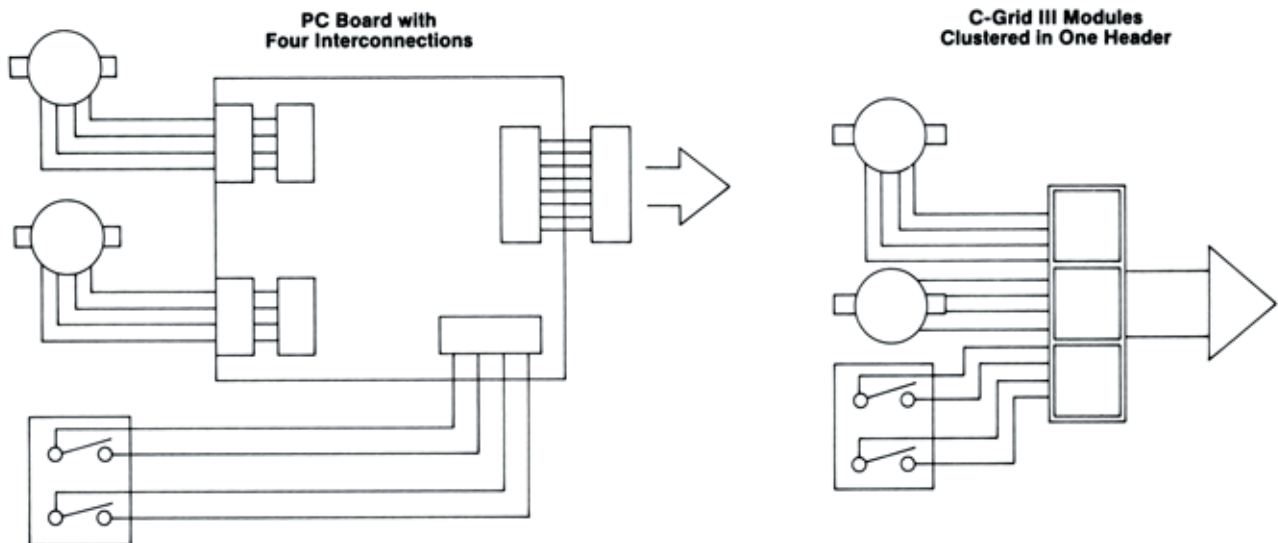

2.54mm (.100") Pitch C-Grid III™ Terminal

90119 Female Crimp

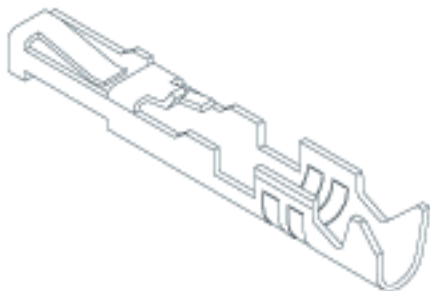

Features and Benefits

- Fully enclosed contact box
- Contact and plating orientation according to DIN 41651
- North/south contact orientation avoids overstress

Reference Information

Product Specification: PS-99020-0001
 Packaging: Chain or bag
 Mates With: 0.64mm (.025") square pins
 Use With: 90123, 90142, 90143, 90156 and 90160
 Designed In: Inches

Electrical

Voltage: 350V
 Current: 3.0A
 Contact Resistance: 20 milliohms max.

Mechanical

Contact Retention to Housing: 15N (1.5kgf)
 Normal Force: 1N

Physical

Contact: Copper Alloy
 Plating: See Table
 Wire Range: 22 to 24 and 26 to 28 AWG
 Wire Insulation Diameter: 1.70mm (.067") max.

Plating A: 1.00µm (39µ") min. Hot Tin dip
 Plating E: 0.38µm (15µ") selective Gold over Nickel and 4µm (160µ") Tin over Nickel
 Plating F: 0.76µm (30µ") selective Gold over Nickel and 4µm (160µ") Tin over Nickel

Not For Use With Molex SL™ Components

Order No.	Plating Option	Packaging	Wire Size (AWG)	Insulation Diameter Range	Lead-free
90119-0109	A	Chain—Left Hand Feed	22-24	1.02/1.47 (.040/.058)	Yes
90119-0110	E				
90119-0111	F				
90119-0120	A				
90119-0121	E				
90119-0122	F				
90119-2109	A	Bag	22-24	1.02/1.47 (.040/.058)	Yes
90119-2110	E				
90119-2111	F				
90119-2120	A				
90119-2121	E				
90119-2122	F				

For other available versions contact Molex

2.54mm (.100") Pitch C-Grid III™ Crimp Connector Housing

90142 Dual Row

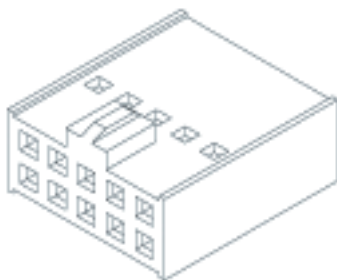

Features and Benefits

- Sizes 6 to 64 circuits
- Polarized
- Friction lock

Reference Information

Product Specification: PS-99020-0001
 Packaging: Bag
 Mates With: 90122, 90130 and 90131
 Use With: 90119
 Designed In: Inches

Electrical

Voltage: 350V
 Current: 3.0A max.
 Contact Resistance: 20 milliohms max.
 Insulation Resistance: 1000 Megohms min.

Mechanical

Contact Retention to Housing: 15N min.
 Normal Force: 1N

Physical

Housing: Black polyphenylene oxide, UL 94V-1
 Operating Temperature: -55 to +105°C

Delivered on a carrier with 20 pieces per strip.

Actual
Size  Universal Polarizing Pin
40713-1
Order No. 15-04-0292

Not For Use With Molex SL™ Components

Circuits	Order No.	Circuits	Order No.	Circuits	Order No.
6	90142-0006	20	90142-0020	38	90142-0038
8	90142-0008	22	90142-0022	40	90142-0040
10	90142-0010	24	90142-0024	44	90142-0044
12	90142-0012	26	90142-0026	50	90142-0050
14	90142-0014	30	90142-0030	54	90142-0054
16	90142-0016	34	90142-0034	60	90142-0060
18	90142-0018	36	90142-0036	64	90142-0064

For other available circuit sizes contact Molex

2.54mm (.100") Pitch C-Grid III™ Header

90120 Single Row Vertical

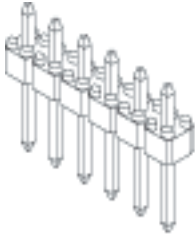

Features and Benefits

- Sizes 2 to 40 circuits
- Easy breakaway to smaller sizes
- Contact and plating orientation according to DIN 41651
- North/south contact orientation avoids overstress
- High pin retention
- High mechanical stability after soldering

Reference Information

Product Specification: PS-99020-0001
Packaging: Bag
Mates With: C-Grid III Housing and Connectors
Designed In: Inches

Electrical

Voltage: 350V
Current: 3.0A
Contact Resistance: 20 milliohms max.
Insulation Resistance: 5000 Megohms min.

Mechanical

Contact Retention to Housing: 20N (2.0kgf) min.
Mating Force: 1N max. Gold and 3N max. Tin
Unmating Force: 0.2N min. Gold and 0.2N min. Tin
Normal Force: 1N

Physical

Housing: Black glass-filled polyester, UL 94V-0
Contact: Copper Alloy, 0.64mm (.025") square pins
Plating: See Table
Operating Temperature: -55 to +125°C

Plating A: 4 μ m (160 μ in) Tin over Nickel
Plating E: 0.38 μ m (15 μ in) selective Gold over Nickel and 4 μ m (160 μ in) Tin over Nickel
Plating F: 0.76 μ m (30 μ in) selective Gold over Nickel and 4 μ m (160 μ in) Tin over Nickel

Not For Use With Molex SL™ Components

Circuits	Order No.			Lead-free
	Plating A	Plating E	Plating F	
3	90120-0123	90120-0763	90120-0923	Yes
4	90120-0124	90120-0764	90120-0924	
5	90120-0125	90120-0765	90120-0925	
6	90120-0126	90120-0766	90120-0926	
7	90120-0127	90120-0767	90120-0927	
8	90120-0128	90120-0768	90120-0928	
9	90120-0129	90120-0769	90120-0929	
10	90120-0130	90120-0770	90120-0930	
11	90120-0131	90120-0771	90120-0931	
12	90120-0132	90120-0772	90120-0932	
13	90120-0133	90120-0773	90120-0933	
14	90120-0134	90120-0774	90120-0934	
15	90120-0135	90120-0775	90120-0935	
16	90120-0136	90120-0776	90120-0936	
17	90120-0137	90120-0777	90120-0937	
18	90120-0138	90120-0778	90120-0938	
19	90120-0139	90120-0779	90120-0939	
20	90120-0140	90120-0780	90120-0940	
21	90120-0141	90120-0781	90120-0941	

For other available versions contact Molex

Circuits	Order No.			Lead-free
	Plating A	Plating E	Plating F	
22	90120-0142	90120-0782	90120-0942	Yes
23	90120-0143	90120-0783	90120-0943	
24	90120-0144	90120-0784	90120-0944	
25	90120-0145	90120-0785	90120-0945	
26	90120-0146	90120-0786	90120-0946	
27	90120-0147	90120-0787	90120-0947	
28	90120-0148	90120-0788	90120-0948	
29	90120-0149	90120-0789	90120-0949	
30	90120-0150	90120-0790	90120-0950	
31	90120-0151	90120-0791	90120-0951	
32	90120-0152	90120-0792	90120-0952	
33	90120-0153	90120-0793	90120-0953	
34	90120-0154	90120-0794	90120-0954	
35	90120-0155	90120-0795	90120-0955	
36	90120-0156	90120-0796	90120-0956	
37	90120-0157	90120-0797	90120-0957	
38	90120-0158	90120-0798	90120-0958	
39	90120-0159	90120-0799	90120-0959	
40	90120-0160	90120-0800	90120-0960	

2.54mm (.100") Pitch C-Grid III™ Header

90131
Dual Row
Vertical

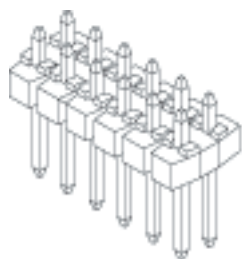

Features and Benefits

- Sizes 4 to 80 circuits
- Easy breakaway to smaller sizes
- Stackable side-to-side
- Contact and plating orientation according to DIN 41651
- North/south contact orientation avoids overstress
- High pin retention and high mechanical stability after soldering

Reference Information

Product Specification: PS-99020-0001
Packaging: Bag
Mates With: C-Grid III Housing and Connectors
Designed In: Inches

Electrical

Voltage: 350V max.
Current: 3.0A
Contact Resistance: 20 milliohms max.
Insulation Resistance: 5000 Megohms min.

Mechanical

Contact Retention to Housing: 20N (2.0kgf) min.
Mating Force: 1N max. Gold and 3N max. Tin
Unmating Force: 0.2N min. Gold and 0.2N min. Tin
Normal Force: 1N

Physical

Housing: Black glass-filled polyester, UL 94V-0
Contact: Copper Alloy, 0.64mm (.025") square pins
Plating: See Table
Operating Temperature: -55 to +125°C

Plating A: 4µm (160µ") Tin over Nickel
Plating E: 0.38µm (15µ") selective Gold over Nickel and 4µm (160µ") Tin over Nickel
Plating F: 0.76µm (30µ") selective Gold over Nickel and 4µm (160µ") Tin over Nickel

Not For Use With Molex SL™ Components

Circuits	Order No.			Lead-free
	Plating A	Plating E	Plating F	
4	90131-0122	90131-0762	90131-0922	Yes
6	90131-0123	90131-0763	90131-0923	
8	90131-0124	90131-0764	90131-0924	
10	90131-0125	90131-0765	90131-0925	
12	90131-0126	90131-0766	90131-0926	
14	90131-0127	90131-0767	90131-0927	
16	90131-0128	90131-0768	90131-0928	
18	90131-0129	90131-0769	90131-0929	
20	90131-0130	90131-0770	90131-0930	
22	90131-0131	90131-0771	90131-0931	
24	90131-0132	90131-0772	90131-0932	
26	90131-0133	90131-0773	90131-0933	
28	90131-0134	90131-0774	90131-0934	
30	90131-0135	90131-0775	90131-0935	
32	90131-0136	90131-0776	90131-0936	
34	90131-0137	90131-0777	90131-0937	
36	90131-0138	90131-0778	90131-0938	
38	90131-0139	90131-0779	90131-0939	
40	90131-0140	90131-0780	90131-0940	

Circuits	Order No.			Lead-free
	Plating A	Plating E	Plating F	
42	90131-0141	90131-0781	90131-0941	Yes
44	90131-0142	90131-0782	90131-0942	
46	90131-0143	90131-0783	90131-0943	
48	90131-0144	90131-0784	90131-0944	
50	90131-0145	90131-0785	90131-0945	
52	90131-0146	90131-0786	90131-0946	
54	90131-0147	90131-0787	90131-0947	
56	90131-0148	90131-0788	90131-0948	
58	90131-0149	90131-0789	90131-0949	
60	90131-0150	90131-0790	90131-0950	
62	90131-0151	90131-0791	90131-0951	
64	90131-0152	90131-0792	90131-0952	
66	90131-0153	90131-0793	90131-0953	
68	90131-0154	90131-0794	90131-0954	
70	90131-0155	90131-0795	90131-0955	
72	90131-0156	90131-0796	90131-0956	
74	90131-0157	90131-0797	90131-0957	
76	90131-0158	90131-0798	90131-0958	
78	90131-0159	90131-0799	90131-0959	

For other available versions contact Molex

2.54mm (.100") Pitch C-Grid III™ Header

90122 Dual Row Right Angle

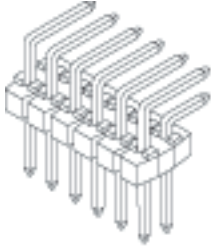

Features and Benefits

- Sizes 4 to 80 circuits
- Easy breakaway to smaller sizes
- Contact and plating orientation according to DIN 41651
- North/south contact orientation avoids overstress
- High pin retention
- High mechanical stability after soldering

Reference Information

Product Specification: PS-99020-0001
 Packaging: Bag
 Mates With: C-Grid III Housing and Connectors
 Designed In: Inches

Electrical

Voltage: 350V
 Current: 3.0A
 Contact Resistance: 20 milliohms max.
 Insulation Resistance: 5000 Megohms min.

Mechanical

Contact Retention to Housing: 20N (2.0kgf) min.
 Mating Force: 1N max. Gold and 3N max. Tin
 Unmating Force: 0.2N min. Gold and 0.2N min. Tin
 Normal Force: 1N

Physical

Housing: Black glass-filled polyester, UL 94V-0
 Contact: Copper Alloy, 0.64mm (.025") square pins
 Plating: See Table
 Operating Temperature: -55 to +125°C

Plating A: 4µm (160µ") Tin over Nickel
 Plating E: 0.38µm (15µ") selective Gold over Nickel and 4µm (160µ") Tin over Nickel
 Plating F: 0.76µm (30µ") selective Gold over Nickel and 4µm (160µ") Tin over Nickel

Not For Use With Molex SL™ Components

Circuits	Order No.			Lead-free
	Plating A	Plating E	Plating F	
4	90122-0122	90122-0762	90122-0922	Yes
6	90122-0123	90122-0763	90122-0923	
8	90122-0124	90122-0764	90122-0924	
10	90122-0125	90122-0765	90122-0925	
12	90122-0126	90122-0766	90122-0926	
14	90122-0127	90122-0767	90122-0927	
16	90122-0128	90122-0768	90122-0928	
18	90122-0129	90122-0769	90122-0929	
20	90122-0130	90122-0770	90122-0930	
22	90122-0131	90122-0771	90122-0931	
24	90122-0132	90122-0772	90122-0932	
26	90122-0133	90122-0773	90122-0933	
28	90122-0134	90122-0774	90122-0934	
30	90122-0135	90122-0775	90122-0935	
32	90122-0136	90122-0776	90122-0936	
34	90122-0137	90122-0777	90122-0937	
36	90122-0138	90122-0778	90122-0938	
38	90122-0139	90122-0779	90122-0939	
40	90122-0140	90122-0780	90122-0940	
42	90122-0141	90122-0781	90122-0941	

For other available versions contact Molex

Circuits	Order No.			Lead-free
	Plating A	Plating E	Plating F	
44	90122-0142	90122-0782	90122-0942	Yes
46	90122-0143	90122-0783	90122-0943	
48	90122-0144	90122-0784	90122-0944	
50	90122-0145	90122-0785	90122-0945	
52	90122-0146	90122-0786	90122-0946	
54	90122-0147	90122-0787	90122-0947	
56	90122-0148	90122-0788	90122-0948	
58	90122-0149	90122-0789	90122-0949	
60	90122-0150	90122-0790	90122-0950	
62	90122-0151	90122-0791	90122-0951	
64	90122-0152	90122-0792	90122-0952	
66	90122-0153	90122-0793	90122-0953	
68	90122-0154	90122-0794	90122-0954	
70	90122-0155	90122-0795	90122-0955	
72	90122-0156	90122-0796	90122-0956	
74	90122-0157	90122-0797	90122-0957	
76	90122-0158	90122-0798	90122-0958	
78	90122-0159	90122-0799	90122-0959	
80	90122-0160	90122-0800	90122-0960	

2.54mm (.100") Pitch C-Grid III™ Shrouded Header

90136
Single Row
Vertical

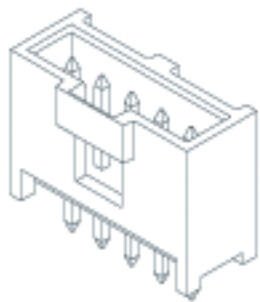

Not For Use With Molex SL™ Components

Circuits	Order No.			Lead-free
	Plating A	Plating E	Plating F	
2	90136-1102	90136-1202	90136-1302	Yes
3	90136-1103	90136-1203	90136-1303	
4	90136-1104	90136-1204	90136-1304	
5	90136-1105	90136-1205	90136-1305	
6	90136-1106	90136-1206	90136-1306	
7	90136-1107	90136-1207	90136-1307	
8	90136-1108	90136-1208	90136-1308	
9	90136-1109	90136-1209	90136-1309	

For other available circuit sizes contact Molex

Features and Benefits

- Sizes 2 to 32 circuits
- Contact and plating orientation according to DIN 41651
- North/south contact orientation avoids overstress
- High pin retention
- Polarized
- Friction lock

Reference Information

Product Specification: PS-99020-0001
Packaging: Tray
Mates With: 90123 and 90156
Designed In: Inches

Electrical

Voltage: 350V
Current: 3.0A
Contact Resistance: 20 milliohms max.
Insulation Resistance: 1000 Megohms min.

Mechanical

Contact Resistance: 20N (2.0kgf) min.
Mating Force: 1N max. Gold and 3N max. Tin
Unmating Force: 0.2N min. Gold and 0.2N min. Tin
Normal Force: 1N

Physical

Housing: Black glass-filled polyester, UL 94V-0
Contact: Copper Alloy, 0.64mm (.025") square pins
Plating: See Table
Operating Temperature: -55 to +125°C

Plating A: 4µm (160µ") Tin over Nickel
Plating E: 0.38µm (15µ") selective Gold over Nickel and 4µm (160µ") Tin over Nickel
Plating F: 0.76µm (30µ") selective Gold over Nickel and 4µm (160µ") Tin over Nickel

Circuits	Order No.			Lead-free
	Plating A	Plating E	Plating F	
10	90136-1110	90136-1210	90136-1310	Yes
12	90136-1112	90136-1212	90136-1312	
15	90136-1115	90136-1215	90136-1315	
18	90136-1118	90136-1218	90136-1318	
22	90136-1122	90136-1222	90136-1322	
25	90136-1125	90136-1225	90136-1325	
30	90136-1130	90136-1230	90136-1330	
32	90136-1132	90136-1232	90136-1332	

2.54mm (.100") Pitch C-Grid III™ Shrouded Header

90136
Single Row
Right Angle

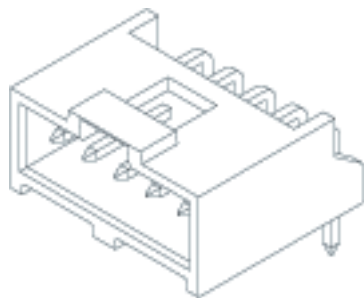

Not For Use With Molex SL™ Components

Circuits	Order No.			Lead-free
	Plating A	Plating E	Plating F	
2	90136-2102	90136-2202	90136-2302	Yes
3	90136-2103	90136-2203	90136-2303	
4	90136-2104	90136-2204	90136-2304	
5	90136-2105	90136-2205	90136-2305	
6	90136-2106	90136-2206	90136-2306	
7	90136-2107	90136-2207	90136-2307	
8	90136-2108	90136-2208	90136-2308	
9	90136-2109	90136-2209	90136-2309	

For other available circuit sizes contact Molex

Features and Benefits

- Sizes 2 to 32 circuits
- Contact and plating orientation according to DIN 41651
- North/south contact orientation avoids overstress
- High pin retention, polarized and friction lock
- 1 through 6 circuits with endwall stabilization features

Reference Information

Product Specification: PS-99020-0001
Packaging: Tray
Mates With: 90123 and 90156
Designed In: Inches

Electrical

Voltage: 350V
Current: 3.0A
Contact Resistance: 20 milliohms max.
Insulation Resistance: 1000 Megohms min.

Mechanical

Contact Retention to Housing: 20N (2.0kgf) min.
Mating Force: 1N Gold and 3N max. Tin
Unmating Force: 0.2N min. Gold and 0.2N min. Tin
Normal Force: 1N

Physical

Housing: Black glass-filled polyester, UL 94V-0
Contact: Copper Alloy, 0.64mm (.025") square pins
Plating: See Table
Operating Temperature: -55 to +125°C

Plating A: 4µm (160µ") Tin over Nickel
Plating E: 0.38µm (15µ") selective Gold over Nickel and 4µm (160µ") Tin over Nickel
Plating F: 0.76µm (30µ") selective Gold over Nickel and 4µm (160µ") Tin over Nickel

Circuits	Order No.			Lead-free
	Plating A	Plating E	Plating F	
10	90136-2110	90136-2210	90136-2310	Yes
12	90136-2112	90136-2212	90136-2312	
15	90136-2115	90136-2215	90136-2315	
18	90136-2118	90136-2218	90136-2318	
22	90136-2122	90136-2222	90136-2322	
25	90136-2125	90136-2225	90136-2325	
30	90136-2130	90136-2230	90136-2330	
32	90136-2132	90136-2232	90136-2332	

2.54mm (.100") Pitch C-Grid III™ Shrouded Header

90130 Dual Row, Vertical Fully Loaded

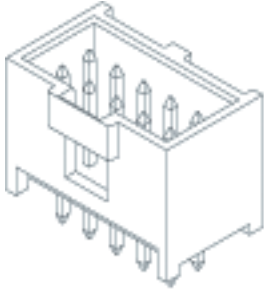

Features and Benefits

- Sizes 6 to 64 circuits
- Contact and plating orientation according to DIN 41651
- North/south contact orientation avoids overstress
- High pin retention
- Polarized
- Friction lock

Reference Information

Product Specification: PS-99020-0001
Packaging: Tray
Mates With: 90142
Designed In: Inches

Electrical

Voltage: 350V
Current: 3.0A
Contact Resistance: 20 milliohms max.
Insulation Resistance: 1000 Megohms min.

Mechanical

Contact Retention to Housing: 20N (2.0kgf) min.
Mating Force: 1N max. Gold and 3N max. Tin
Unmating Force: 0.2N min. Gold and 0.2N min. Tin
Normal Force: 1N

Physical

Housing: Black glass-filled polyester, UL 94V-0
Contact: Copper Alloy, 0.64mm (.025") square pins
Plating: See Table
Operating Temperature: -55 to +125°C

Not For Use With Molex SL™ Components

Circuits	Order No.			Lead-free
	Plating A	Plating E	Plating F	
6	90130-1106	90130-1206	90130-1306	Yes
8	90130-1108	90130-1208	90130-1308	
10	90130-1110	90130-1210	90130-1310	
12	90130-1112	90130-1212	90130-1312	
14	90130-1114	90130-1214	90130-1314	
16	90130-1116	90130-1216	90130-1316	
18	90130-1118	90130-1218	90130-1318	
20	90130-1120	90130-1220	90130-1320	
24	90130-1124	90130-1224	90130-1324	

For other available circuit sizes contact Molex

Plating A: 4µm (160µ") Tin over Nickel

Plating E: 0.38µm (15µ") selective Gold over Nickel and 4µm (160µ") Tin over Nickel

Plating F: 0.76µm (30µ") selective Gold over Nickel and 4µm (160µ") Tin over Nickel

Circuits	Order No.			Lead-free
	Plating A	Plating E	Plating F	
26	90130-1126	90130-1226	90130-1326	Yes
30	90130-1130	90130-1230	90130-1330	
34	90130-1134	90130-1234	90130-1334	
38	90130-1138	90130-1238	90130-1338	
40	90130-1140	90130-1240	90130-1340	
50	90130-1150	90130-1250	90130-1350	
60	90130-1160	90130-1260	90130-1360	
64	90130-1164	90130-1264	90130-1364	

2.54mm (.100") Pitch C-Grid III™ Shrouded Header

90130 Dual Row, Right Angle Fully Loaded

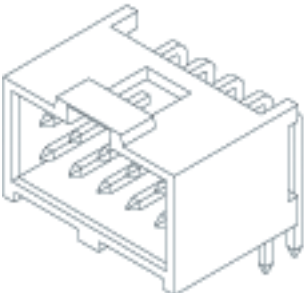

Features and Benefits

- Sizes 6 to 64 circuits
- Contact and plating orientation according to DIN 41651
- North/south contact orientation avoids overstress
- High pin retention
- Polarized
- Friction lock

Reference Information

Product Specification: PS-99020-0001
Packaging: Tray
Mates With: 90142
Designed In: Inches

Electrical

Voltage: 350V max.
Current: 3.0A
Contact Resistance: 20 milliohms max.
Insulation Resistance: 1000 Megohms min.

Mechanical

Contact Retention to Housing: 20N (2.0kgf) min.
Mating Force: 1N max. Gold and 3N max. Tin
Unmating Force: 0.2N min. Gold and 0.2N min. Tin
Nominal Force: 1N

Physical

Housing: Black glass-filled polyester, UL 94V-0
Contact: Copper Alloy, 0.64mm (.025") square pins
Plating: See Table
Operating Temperature: -55 to +125°C

Not For Use With Molex SL™ Components

Circuits	Order No.			Lead-free
	Plating A	Plating E	Plating F	
6	90130-3106	90130-3206	90130-3306	Yes
8	90130-3108	90130-3208	90130-3308	
10	90130-3110	90130-3210	90130-3310	
12	90130-3112	90130-3212	90130-3312	
14	90130-3114	90130-3214	90130-3314	
16	90130-3116	90130-3216	90130-3316	
18	90130-3118	90130-3218	90130-3318	
20	90130-3120	90130-3220	90130-3320	
24	90130-3124	90130-3224	90130-3324	

For other available circuit sizes contact Molex

Plating A: 4µm (160µ") Tin over Nickel

Plating E: 0.38µm (15µ") selective Gold over Nickel and 4µm (160µ") Tin over Nickel

Plating F: 0.76µm (30µ") selective Gold over Nickel and 4µm (160µ") Tin over Nickel

Circuits	Order No.			Lead-free
	Plating A	Plating E	Plating F	
26	90130-3126	90130-3226	90130-3326	Yes
30	90130-3130	90130-3230	90130-3330	
34	90130-3134	90130-3234	90130-3334	
38	90130-3138	90130-3238	90130-3338	
40	90130-3140	90130-3240	90130-3340	
50	90130-3150	90130-3250	90130-3350	
60	90130-3160	90130-3260	90130-3360	
64	90130-3164	90130-3264	90130-3364	

2.54mm (.100") Pitch C-Grid III™ PC Board Connectors

90151 Dual Row, Vertical

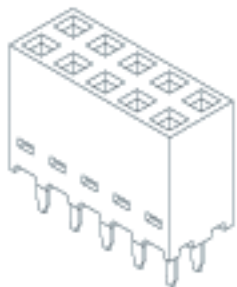

Features and Benefits

- Sizes 4 to 64 circuits
- Contact and plating orientation according to DIN 41651
- Stackable in 2 directions
- Meets HE 13/14 specification

Reference Information

Product Specification: PS-99020-0001
Packaging: Tube
Mates With: 0.64mm (.025") square pins
Use With: 1.57mm (.062") thick PC boards
Designed In: Inches

Electrical

Voltage: 350V
Current: 3.0A
Contact Resistance: 20 milliohms max.
Insulation Resistance: 1000 Megohms min.

Mechanical

Contact Retention to Housing: 15N min.
Mating Force: 1N max. Gold and 3N max. Tin
Unmating Force: 0.2N min. Gold and 0.2N min. Tin
Normal Force: 1N

Physical

Housing: Black glass-filled polyester, UL 94V-0
Contact: Copper Alloy
Plating: See Table
Operating Temperature: -55 to +125°C
Recommended Mating Pin Length:
5.65mm (.222") min. to 7.00mm (.275") max.

Plating A: 1.00µm (39µ") min. Hot Tin dip
Plating E: 0.38µm (15µ") selective Gold over Nickel and 4µm (160µ") Tin over Nickel
Plating F: 0.76µm (30µ") selective Gold over Nickel and 4µm (160µ") Tin over Nickel

Not For Use With Molex SL™ Components

Circuits	Order No.						Lead-free
	Straight Tail			Kinked Tail			
	Plating A	Plating E	Plating F	Plating A	Plating E	Plating F	
4	90151-2104	90151-2204	90151-2304	90151-3104	90151-3204	90151-3304	Yes
6	90151-2106	90151-2206	90151-2306	90151-3106	90151-3206	90151-3306	
8	90151-2108	90151-2208	90151-2308	90151-3108	90151-3208	90151-3308	
10	90151-2110	90151-2210	90151-2310	90151-3110	90151-3210	90151-3310	
14	90151-2114	90151-2214	90151-2314	90151-3114	90151-3214	90151-3314	
16	90151-2116	90151-2216	90151-2316	90151-3116	90151-3216	90151-3316	
20	90151-2120	90151-2220	90151-2320	90151-3120	90151-3220	90151-3320	
26	90151-2126	90151-2226	90151-2326	90151-3126	90151-3226	90151-3326	
34	90151-2134	90151-2234	90151-2334	90151-3134	90151-3234	90151-3334	
40	90151-2140	90151-2240	90151-2340	90151-3140	90151-3240	90151-3340	
50	90151-2150	90151-2250	90151-2350	90151-3150	90151-3250	90151-3350	
60	90151-2160	90151-2260	90151-2360	90151-3160	90151-3260	90151-3360	
64	90151-2164	90151-2264	90151-2364	90151-3164	90151-3264	90151-3364	

For other available circuit sizes contact Molex

2.54mm (.100") Pitch C-Grid III™ PC Board Connectors

90152 Dual Row, Horizontal

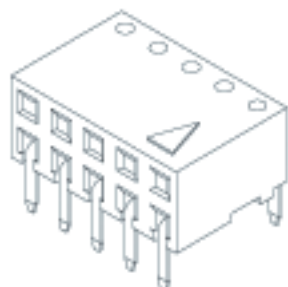

Features and Benefits

- Sizes 4 to 64 circuits
- Contact and plating orientation according to DIN 41651
- Stackable end-to-end
- Meets HE 13/14 specification

Reference Information

Product Specification: PS-99020-0001
Packaging: Tube
Mates With: 0.64mm (.025") square pins
Use With: 1.57mm (.062") thick PC boards
Designed In: Inches

Electrical

Voltage: 350V
Current: 3.0A
Contact Resistance: 20 milliohms max.
Insulation Resistance: 1000 Megohms min.

Mechanical

Contact Retention to Housing: 8.8N min.
Mating Force: 1N max. Gold and 3N max. Tin
Unmating Force: 0.2N min. Gold and 0.2N min. Tin
Normal Force: 1N

Physical

Housing: Black glass-filled polyester, UL 94V-0
Contact: Copper Alloy
Plating: See Table
Operating Temperature: -55 to +125°C
Recommended Mating Pin Length:
5.65mm (.222") min. to 7.00mm (.275") max.

Plating A: 1.00µm (39µ") min. Hot Tin dip
Plating E: 0.38µm (15µ") selective Gold over Nickel and 4µm (160µ") Tin over Nickel
Plating F: 0.76µm (30µ") selective Gold over Nickel and 4µm (160µ") Tin over Nickel

Not For Use With Molex SL™ Components

Circuits	Order No.						Lead-free
	Straight Tail			Kinked Tail			
	Plating A	Plating E	Plating F	Plating A	Plating E	Plating F	
4	90152-2104	90152-2204	90152-2304	90152-3104	90152-3204	90152-3304	Yes
6	90152-2106	90152-2206	90152-2306	90152-3106	90152-3206	90152-3306	
8	90152-2108	90152-2208	90152-2308	90152-3108	90152-3208	90152-3308	
10	90152-2110	90152-2210	90152-2310	90152-3110	90152-3210	90152-3310	
14	90152-2114	90152-2214	90152-2314	90152-3114	90152-3214	90152-3314	
16	90152-2116	90152-2216	90152-2316	90152-3116	90152-3216	90152-3316	
20	90152-2120	90152-2220	90152-2320	90152-3120	90152-3220	90152-3320	
26	90152-2126	90152-2226	90152-2326	90152-3126	90152-3226	90152-3326	
34	90152-2134	90152-2234	90152-2334	90152-3134	90152-3234	90152-3334	
40	90152-2140	90152-2240	90152-2340	90152-3140	90152-3240	90152-3340	
50	90152-2150	90152-2250	90152-2350	90152-3150	90152-3250	90152-3350	
60	90152-2160	90152-2260	90152-2360	90152-3160	90152-3260	90152-3360	
64	90152-2164	90152-2264	90152-2364	90152-3164	90152-3264	90152-3364	

For other available circuit sizes contact Molex

2.54mm (.100") Pitch
 KK®
 Product Overview

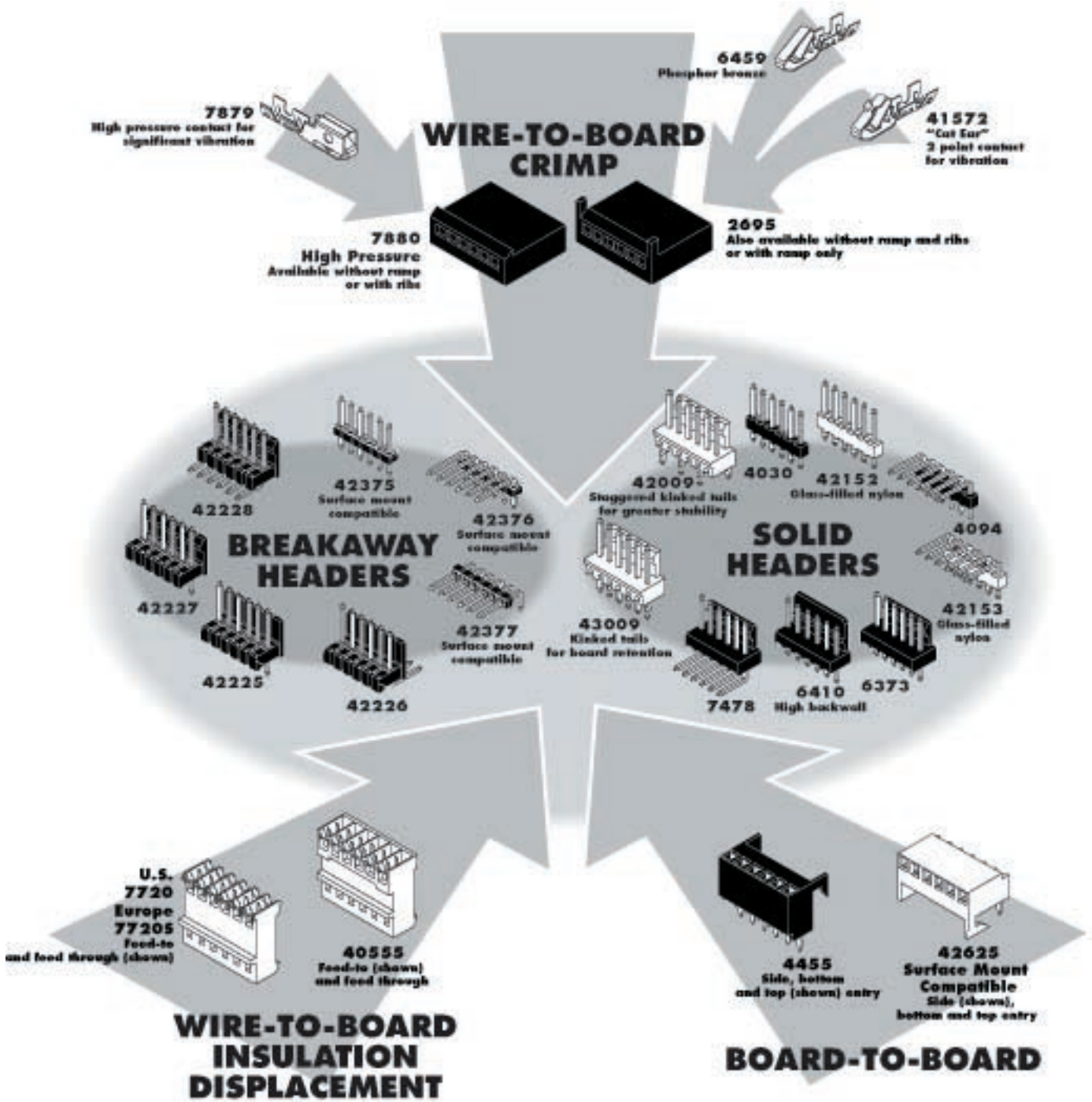

2.54mm (.100") Pitch PCB and Wire Connectors

2.54mm (.100") Pitch KK® Crimp Terminal

2759/6459

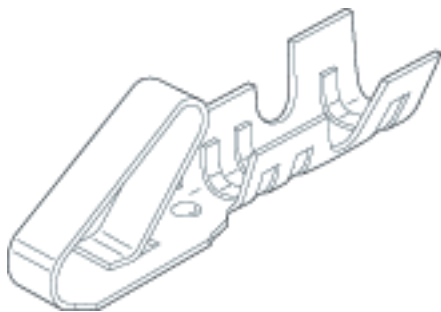

Features and Benefits

- Standard cantilever terminal
- Cantilever design provides high contact pressure
- Wiping action cleans oxides when connector is mated
- 2759 Series is Brass
- 6459 Series is Phosphor Bronze

Reference Information

Product Specification: PS-10-07
Packaging: Reel or bag
Tooling Information: See crimp tooling section
UL File No.: E29179
CSA File No.: LR19980
Use With: 2695, 5051 and 6745 housings
Designed In: Inches

Electrical

Voltage: 250V
Current: 6459—4.0A
2759—2.5A
Contact Resistance: 20 milliohms max.
Dielectric Withstanding Voltage: 1500V
Insulation Resistance: 50K Megohms min.

Mechanical

Wire Pull-Out Force:

Wire Gauge (AWG)	22	24	26	28	30
Pull-Out Force (lb)	10	8	6	4	3

Mating Force: 255g max.
Unmating Force: 50g min.
Normal Force: 200g min.

Physical

Contact: 6459—Phosphor Bronze; 2759—Brass
Plating: See Table
Wire Accommodation: 22 to 30 AWG
Insulation Range: 1.58mm (.062") diameter max.

Contact	Order No.						Wire Gauge (AWG)	Insulation OD	Lead-free
	Tin Plating		15µ" Gold Plating		15µ" Selective Gold Plating				
	Reel	Bag	Reel	Bag	Reel	Bag			
Brass	08-50-0113	08-50-0114	08-56-0109	08-56-0110	08-55-0101	08-55-0102	22-30	1.57 (.062)	Yes
Phosphor Bronze	08-52-0101	08-52-0123	08-65-0813	08-65-0814	08-65-0815	08-65-0816			

2.54mm (.100") Pitch KK® Cat Ear Terminal

5159



Features and Benefits

- Similar to 2759/6459 Series with cat ears
- Cat ears provide 2 high pressure points of contact
- Suitable for high vibrational requirements

Reference Information

Product Specification: PS-10-07
Packaging: Bag or reel
Tooling Information: See crimp tooling section
UL File No.: E29179
CSA File No.: LR19980
Use With: 2695, 5051 and 6471
Designed In: Inches

Electrical

Voltage: 250V
Current: 3.0A
Contact Resistance: 20 milliohms max.
Dielectric Withstanding Voltage: 1000V AC
Insulation Resistance: 1000 Megohms min.

Physical

Contact: Phosphor Bronze and Brass
Plating: Tin
Wire Accommodation: 22 to 30 AWG

Order No.				Lead-free
Phosphor Bronze		Brass		
Bag	Reel	Bag	Reel	
08-70-0049	08-70-0048	08-70-0069	08-70-0064	Yes

Preferred version in the Far East

2.54mm (.100") Pitch KK[®] Crimp Terminal

4809
Anti-Fishhooking



Features and Benefits

- Avoids tangling at pre-assembly
- Available with cat ears

Reference Information

Product Specification: PS-10-07
Packaging: Reel or bag
Tooling Information: See crimp tooling section
UL File No.: E29179
CSA File No.: LR19980
Mates With: 5051-NM and 6471 housings
Designed In: Inches

Electrical

Voltage: 250V
Current: 2.5A
Contact Resistance: 20 milliohms max.
Dielectric Withstanding Voltage: 1500V
Insulation Resistance: 500K Megohms min.

Mechanical

Contact Insertion Force: 681g max.
Contact Retention to Housing: 27.21g min.
Wire Pull-Out Force: 3 lb min.
Mating Force: 199g max.
Unmating Force: 57g min.
Normal Force: 300g
Durability: 50 cycles Gold and 25 cycles Tin

Physical

Contact: Brass
Plating: Gold, select Gold and Tin
Operating Temperature: Storage— -40 to +105°C
Operating— 0 to +75°C
Wire Accommodation: 22 to 30 AWG

Order No.		Plating	Crimp Wire Size	Insulation Diameter	Engineering No.	Lead-free
Bag	Reel					
08-50-0032	08-50-0031	1.00 to 2.50µm Tin	22-30	1.57 (.062) max.	4809	Yes
08-55-0111	08-55-0110	0.38µm Gold in contact area only				
08-56-0115	08-56-0120	0.38µm Gold in contact area, Gold flash overall				

2.54mm (.100") Pitch KK[®] Crimp Terminal

7879
High Pressure

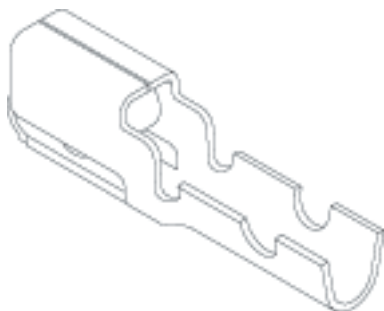

Features and Benefits

- Multiple contacting points
- Patented triple cantilever with box shroud
- Suitable for high vibration requirements
- Box shroud prevents contamination to the contact surface
- Crimping die or hand tool available

Reference Information

Product Specification: PS-7879
Packaging: Reel or bag
Tooling Information: See crimp tooling section
UL File No.: E29179
CSA File No.: LR19980
Use With: 7880 housings
Designed In: Inches

Electrical

Voltage: 250V
Current: 2.5A
Contact Resistance: 10 milliohms max.
Dielectric Withstanding Voltage: 1500V
Insulation Resistance: 50K Megohms min.

Mechanical

Wire Pull-Out Force:

Wire Gauge (AWG)	22	24	26	28	30
Pull-Out Force (lb)	10	8	6	4	3

Mating Force: 475g max.
Unmating Force: 100g min.
Normal Force: 430g min.

Physical

Contact: Brass
Plating: See Table
Wire Accommodation: 22 to 30 AWG
Insulation Range: 1.58mm (.062") diameter max.

Order No.		Plating	Wire Gauge (AWG)	Insulation Diameter	Lead-free
Reel	Bag				
08-50-0004	08-50-0005	Tin/Copper	22-30	1.57 (.062) max.	Yes
08-55-0124	08-55-0129	Select Gold			

Recommended wire range assumes stranded wire

2.54mm (.100") Pitch KK® Crimp Terminal Housing

2695/6471

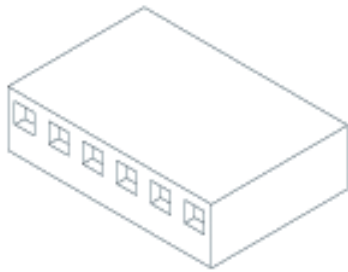

Features and Benefits

- Sizes 1 to 25 circuits
- 6471 is end-to-end stackable (2 housings only)
- 2695 version with or without locking ramp and polarizing ribs

Reference Information

Product Specification: PS-10-07
 Packaging: Bag
 UL File No.: E29179
 CSA File No.: LR19980
 Mates With: Molex KK 2.54mm (.100") pitch headers and 0.04mm (.025") pins
 Use With: 2695—2759, 6459 or 41572 terminals
 6471—4809 terminals
 Designed In: Inches

Electrical*

Voltage: 250V
 Current: Phosphor Bronze—4.0A max.
 Brass—2.5A max.
 Dielectric Withstanding Voltage: 1500V AC
 Insulation Resistance: 50K Megohms min.

Mechanical*

Contact Insertion Force: 681g (1.5 lb) max.
 Contact Retention to Housing: 3.63kg (8 lb) min.
 Mating Force: 199g max.
 Unmating Force: 57g min.
 Normal Force: 200g min.

Physical

Housing: Nylon, UL 94V-0
 Operating Temperature: 0 to +75°C

Circuits	Order No.			
	2695		6471	
	With Locking Ramp	With Locking Ramp and Polarizing Ribs	Without Locking Ramp or Ribs	With Locking Ramp and Polarizing Ribs [†]
1			22-01-2011	
2	22-01-2027	22-01-3027	22-01-2021	22-01-2025
3	22-01-2037	22-01-3037	22-01-2031	22-01-2035
4	22-01-2047	22-01-3047	22-01-2041	22-01-2045
5	22-01-2057	22-01-3057	22-01-2051	22-01-2055
6	22-01-2067	22-01-3067	22-01-2061	22-01-2065
7	22-01-2077	22-01-3077	22-01-2071	22-01-2075
8	22-01-2087	22-01-3087	22-01-2081	22-01-2085
9	22-01-2097	22-01-3097	22-01-2091	22-01-2095
10	22-01-2107	22-01-3107	22-01-2101	22-01-2105
11	22-01-2117	22-01-3117	22-01-2111	22-01-2115
12	22-01-2127	22-01-3127	22-01-2121	22-01-2125
13	22-01-2137	22-01-3137	22-01-2131	22-01-2135

Note: When mating polarizing rib version with breakaway friction lock header or polarizing wall series, the end friction lock or polarizing wall of header must be removed

* When mated with Molex product only

† For circuits 19-28, contact Molex

Circuits	Order No.			
	2695		6471	
	With Locking Ramp	With Locking Ramp and Polarizing Ribs	Without Locking Ramp or Ribs	With Locking Ramp and Polarizing Ribs [†]
14	22-01-2147	22-01-3147	22-01-2141	22-01-2145
15	22-01-2157	22-01-3157	22-01-2151	22-01-2155
16	22-01-2167	22-01-3167	22-01-2161	22-01-2165
17	22-01-2177	22-01-3177	22-01-2171	22-01-2175
18	22-01-2187	22-01-3187	22-01-2181	22-01-2185
19	22-01-2197	22-01-3197	22-01-2191	
20	22-01-2207	22-01-3207	22-01-2201	
21	22-01-2217	22-01-3217	22-01-2211	
22	22-01-2227	22-01-3227	22-01-2221	
23	22-01-2237	22-01-3237	22-01-2231	
24	22-01-2247	22-01-3247	22-01-2241	
25	22-01-2257	22-01-3257	22-01-2251	

	Order No.
Polarizing Key	15-04-9209
Polarizing Peg	15-04-9210

2.54mm (.100") Pitch KK® Crimp Terminal Housing

7880 High Pressure

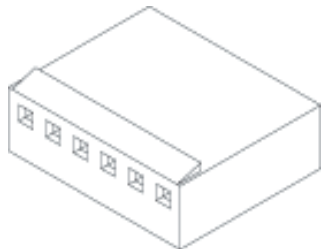

Features and Benefits

- Sizes 1 to 28 circuits
- Standard with locking ramp
- Suitable for high vibration requirements

Reference Information

Product Specification: PS-7879
 Packaging: Bag
 UL File No.: E29179
 CSA File No.: LR19980
 Mates With: Molex KK 2.54mm (.100") pitch headers
 Use With: 7879 terminals
 Designed In: Inches

Electrical*

Voltage: 250V
 Current: 2.5A
 Dielectric Withstanding Voltage: 1500V AC
 Insulation Resistance: 500K Megohms min.

Mechanical*

Contact Insertion Force: 1.5 lb max.
 Contact Retention to Housing: 8 lb min.
 Mating Force: 475g max.
 Unmating Force: 100g min.
 Normal Force: 430g min.

Physical

Housing: Nylon, UL 94V-0
 Operating Temperature: -0 to +75°C

Circuits	Order No.
1	10-11-2013
2	10-11-2023
3	10-11-2033
4	10-11-2043
5	10-11-2053
6	10-11-2063
7	10-11-2073
8	10-11-2083
9	10-11-2093
10	10-11-2103

Circuits	Order No.
11	10-11-2113
12	10-11-2123
13	10-11-2133
14	10-11-2143
15	10-11-2153
16	10-11-2163
17	10-11-2173
18	10-11-2183
19	10-11-2193

Circuits	Order No.
20	10-11-2203
21	10-11-2213
22	10-11-2223
23	10-11-2233
24	10-11-2243
25	10-11-2253
26	10-11-2263
27	10-11-2273
28	10-11-2283

* When mated with Molex product only

Note: In the Far East this housing has a different Engineering Series No. and different Order No.

2.54mm (.100") Pitch KK[®] Connector

7720
24, 26 or 28 AWG, IDT
Double Cantilever Contact

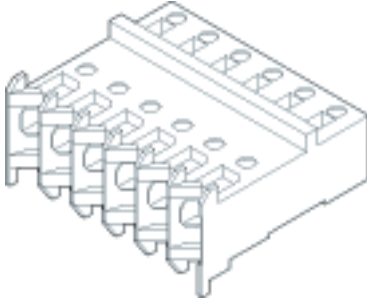

Features and Benefits

- Sizes 2 to 28 circuits
- 4 points of contact on conductor
- Feed-to and feed-through versions available
- End-to-end polarization optional
- Molded-in strain reliefs
- Terminals available with Gold plating (contact Molex for details)

Reference Information

Product Specification: PS-7690
Packaging: Bag
UL File No.: E29179
CSA File No.: LR19980
Mates With: Molex KK 2.54mm (.100") pitch headers and 0.64mm (.025") pins
Use Molex Cable: 7234, 7307, 7767, 8996, 8997, 24214 and 24241
Designed In: Inches

Electrical

Voltage: 250V
Current: 3.5A max. (24 AWG)
Contact Resistance: 20 milliohms max.
Dielectric Withstanding Voltage: 1500V AC
Insulation Resistance: 200K Megohms min.

Mechanical

Contact Retention to Housing: 6 lb min.
Mating Force: 255g max.
Unmating Force: 85g min.
Normal Force: 6.5 oz min.

Physical

Housing: Nylon, UL 94V-2
Contact: Phosphor Bronze
Plating: Tin
Operating Temperature: 0 to +75°C
Wire Range: 0.76 to 1.52mm (.030 to .060") OD max. (Discrete Wire) and 0.76 to 1.27mm (.030 to .050") OD max. (mass termination)

Order No.						Color	Type of Wire Terminated	Lead-free
Feed-Through		Feed-To						
Without Ramp	With Ramp	With Polarized Ramp	Without Ramp	With Ramp	With Polarized Ramp			
22-26-7XX1	22-26-8XX1	22-26-9XX1	22-41-3XX1	22-41-4XX1	22-41-5XX1	Brown	26 AWG stranded or solid, and 28 AWG solid, stranded or fused	Yes
22-26-7XX2	22-26-8XX2	22-26-9XX2	22-41-3XX2	22-41-4XX2	22-41-5XX2	Green	24 AWG stranded, solid, fused, topcoat, and 26 AWG fused and topcoat	

Replace XX with number of circuits, 02 to 28

Note: Some wires require deviation from chart

	Order No.
Polarizing Key	15-04-0292
Feed To	15-05-8XX7
Feed Through	15-05-8XX5

2.54mm (.100") Pitch KK[®] Connector

7720
22 AWG, IDT
Double Cantilever Contact

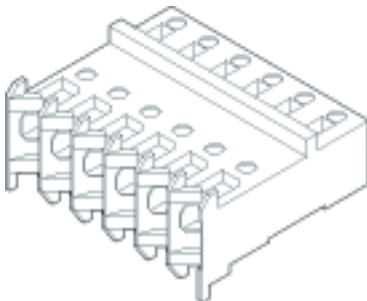

Features and Benefits

- Sizes 2 to 28 circuits
- 4 points of contact on conductor
- Feed-to and feed-through versions available
- End-to-end polarization optional
- Molded-in strain reliefs
- Terminals available with Gold plating (contact Molex for details)

Reference Information

Product Specification: PS-7690
Packaging: Bag
UL File No.: E29179
CSA File No.: LR19980
Mates With: Molex KK 2.54mm (.100") pitch headers and 0.64mm (.025") pins
Use Molex Cable: 7234, 7307, 7767, 8996, 8997, 24214 and 24241
Designed In: Inches

Electrical

Voltage: 250V
Current: 3.5A max.
Contact Resistance: 20 milliohms max.
Dielectric Withstanding Voltage: 1500V AC
Insulation Resistance: 200K Megohms min.

Mechanical

Contact Retention to Housing: 6 lb min.
Mating Force: 255g max.
Unmating Force: 85g min.
Normal Force: 6.5 oz min.

Physical

Housing: Nylon, UL 94V-2
Contact: Phosphor Bronze
Plating: Tin
Operating Temperature: 0 to +75°C
Wire Range: 0.76 to 1.52mm (.030 to .060") OD max. (Discrete Wire) and 0.76 to 1.27mm (.030 to .050") OD max. (mass termination)

Order No.						Color	Type of Wire Terminated	Lead-free
Feed-Through			Feed-To					
Without Ramp	With Ramp	With Polarized Ramp	Without Ramp	With Ramp	With Polarized Ramp			
22-42-6XX0	22-42-6XX1	22-42-6XX2	22-42-6XX3	22-42-6XX4	22-42-6XX5	Black	22 AWG stranded tinned	Yes

Replace XX with number of circuits, 02 to 28

	Order No.
Polarizing Key	15-04-0292
Feed To	15-05-8XX7
Feed Through	15-05-8XX5

2.54mm (.100") Pitch KK[®] Connector

7720S

IDT, High Pressure Cat Ear Contact System

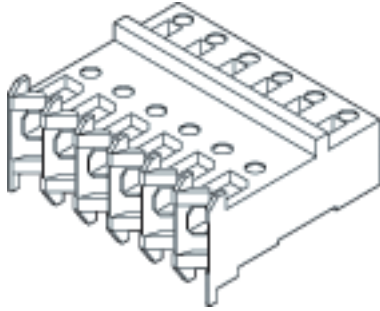

Features and Benefits

- Sizes 2 to 28 circuits
- Standard with locking ramp
- Molded-in strain reliefs

Reference Information

Product Specification: PSX-7690S
 Packaging: Bag
 Tooling Information: See end of section
 UL File No.: E29179
 CSA File No.: LR19980
 Mates With: Molex KK 2.54mm (.100") pitch headers
 and 0.64mm (.025") pins
 Use Molex Cable: 7234, 7307, 7767, 8996, 8997,
 24214, 24226 and 24241
 Designed In: Inches

Electrical

Voltage: 250V
 Current: 2.5A
 Contact Resistance: 20 milliohms max.
 Dielectric Withstanding Voltage: 1500V
 Insulation Resistance: 200K Megohms min.

Mechanical

Contact Retention to Housing: 8 lb min.
 Wire Pull-Out Force: 1.35 lb min.
 Mating Force: 9 oz max.
 Unmating Force: 2 oz min.
 Normal Force: 6.5 oz min.

Physical

Housing: Nylon, UL 94V-2
 Contact: Brass
 Plating: Tin
 Wire Range: 0.76mm (.030") to 1.42mm (.056") OD

2.54mm (.100") Pitch PCB and Wire Connectors

Circuits	Version		Lead-free
	H	J	
2	22-50-3025	38-00-2092	Yes
3	22-50-3035	38-00-2093	
4	22-50-3045	38-00-2094	
5	22-50-3055	38-00-2095	
6	22-50-3065	38-00-2096	
7	22-50-3075	38-00-2097	
8	22-50-3085	38-00-2098	
9	22-50-3095	38-00-2099	
10	22-50-3105	38-00-2100	

Circuits	Version		Lead-free
	H	J	
11	22-50-3115	38-00-2101	Yes
12	22-50-3125	38-00-2102	
13	22-50-3135	38-00-2103	
14	22-50-3145	38-00-2104	
15	22-50-3155	38-00-2105	
16	22-50-3165	38-00-2106	
17	22-50-3175	38-00-2107	
18	22-50-3185	38-00-2108	
19	22-50-3195	38-00-2109	

Circuits	Version		Lead-free
	H	J	
20	22-50-3205	38-00-2110	Yes
21	22-50-3215	38-00-2111	
22	22-50-3225	38-00-2112	
23	22-50-3235	38-00-2113	
24	22-50-3245	38-00-2114	
25	22-50-3255	38-00-2115	
26	22-50-3265	38-00-2116	
27	22-50-3275	38-00-2117	
28	22-50-3285	38-00-2118	

Color Identification Stripe		Type of Wire Terminated [all wires have a max. insulation diameter of 1.42mm (.056")]
ID Slot Version	Color	
H	Green	24 AWG stranded, 26 AWG solid and fused, and 28 AWG fused
J	Brown	26 AWG stranded, and 28 AWG solid and stranded

Polarizing Key	Order No.
	15-04-0292

2.54mm (.100") Pitch KK[®] Breakaway Header

42375
Vertical

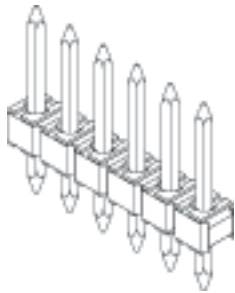

Features and Benefits

- Sizes 2 to 36 circuits
- Available with kinked PC tails
- .240, .295 and .320" standard mating lengths
- Voided circuits available (contact Molex)

Reference Information

Product Specification: PS-10-07
 Packaging: Bag
 UL File No.: E29179
 CSA File No.: LR19980
 Mates With: 2695, 4455, 6471, 7720, 7859, 7880,
 40556, 70066A, 70400A, 70430, 90147
 and 90148
 Designed In: Inches

Electrical

Voltage: 250V
 Current: 4.0A
 Contact Resistance: 20 milliohms max.
 Dielectric Withstanding Voltage: 1500V
 Insulation Resistance: 50K Megohms min.

Mechanical

Durability: Tin—25 cycles max.
 Gold—100 cycles max.

Physical

Housing: Glass-filled nylon, UL 94V-0
 Contact: Phosphor Bronze, 0.64mm (.025") square
 Plating: See Table
 Operating Temperature: 0 to +75°C

Plating Option	Order No.						Lead-free
	Mating End Length = 6.09mm (.240")		Mating End Length = 7.49mm (.295")		Mating End Length = 8.13mm (.320")		
	PC Tail Length = 3.18mm (.125")	PC Tail Length = 3.43mm (.135") Kinked PC Tail	PC Tail Length = 3.05mm (.120")	PC Tail Length = 3.43mm (.135") Kinked PC Tail	PC Tail Length = 3.05mm (.130")	PC Tail Length = 3.43mm (.135") Kinked PC Tail	
Tin	22-28-4XX0	22-28-5XX0	22-28-4XX2	22-28-5XX2	22-28-4XX1	22-28-5XX1	Yes
15µ" select Gold	22-28-4XX3	22-28-5XX3	22-28-4XX5	22-28-5XX5	22-28-4XX4	22-28-5XX4	
30µ" select Gold	22-28-4XX6	22-28-5XX6	22-28-4XX8	22-28-5XX8	22-28-4XX7	22-28-5XX7	

Replace XX with no. of circuits, 02-36

2.54mm (.100") Pitch KK[®] Breakaway Header

42377
Right Angle

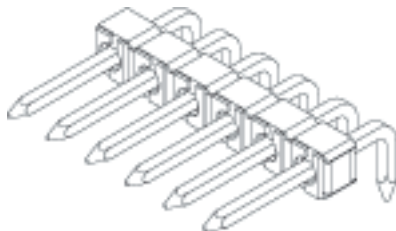

Features and Benefits

- Sizes 2 to 36 circuits
- Available with kinked PC tails
- .244 or .324" standard mating lengths
- Voided circuits available (contact Molex)
- Various pin lengths available

Reference Information

Product Specification: PS-10-07
 Packaging: Bag
 UL File No.: E29179
 CSA File No.: LR19980
 Mates With*: 2695, 4455, 6471, 7720, 7859, 7880,
 40556, 70066A, 70400A, 70430, 90147 and 90148
 Designed In: Inches

Electrical

Voltage: 250V
 Current: 4.0A
 Contact Resistance: 20 milliohms max.
 Dielectric Withstanding Voltage: 1500V
 Insulation Resistance: 50K Megohms min.

Mechanical

Durability: Tin—25 cycles max.
 Gold—100 cycles max.

Physical

Housing: Glass-filled nylon, UL 94V-0
 Contact: Phosphor Bronze, 0.64mm (.025") square
 Plating: See Table
 Operating Temperature: 0 to +75°C

Plating Option	Order No.				Lead-free
	Mating End Length = 6.20mm (.244")		Mating End Length = 8.23mm (.324")		
	PC Tail Length = 3.05mm (.120")	PC Tail Length = 3.43mm (.135") Kinked PC Tail	PC Tail Length = 3.05mm (.120")	PC Tail Length = 3.43mm (.135") Kinked PC Tail	
Tin	22-28-8XX0	22-28-9XX0	22-28-8XX1	22-28-9XX1	Yes
15µ" select Gold	22-28-8XX2	22-28-9XX2	22-28-8XX3	22-28-9XX3	
30µ" select Gold	22-28-8XX4	22-28-9XX4	22-28-8XX5	22-28-9XX5	

Replace XX with no. of circuits, 02-36

* 2695, 4455 and 7880 mate when 42377 is at board edge only
 Circuit 1 designation is used to orient the header to locate the voided circuit. Review mating connector to assure correct mating orientation.

2.54mm (.100") Pitch KK[®] Breakaway Header

42376
Right Angle

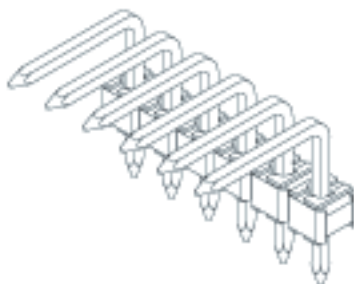

Features and Benefits

- Sizes 2 to 36 circuits
- Available with kinked PC tails
- .361 and .405" standard mating lengths
- Tin and 15 or 30 μ " Gold plating
- Voids optional (contact Molex)
- Surface Mount Compatible

Reference Information

Product Specification: PS-10-07
Packaging: Bag
Tooling Information: See cutting tool section
UL File No.: E29179
CSA File No.: LR19980
Mates With: 2695, 4455, 6471, 7720, 7859, 7880, 40556, 70066A, 70400A, 70430, 90147 and 90148
Designed In: Inches

Electrical

Voltage: 250V
Current: 4.0A
Contact Resistance: 20 milliohms max.
Dielectric Withstanding Voltage: 1500V
Insulation Resistance: 50,000 Megohms min.

Mechanical

Durability: Tin—25 cycles max.
Gold—100 cycles max.

Physical

Housing: Glass-filled polyester, UL 94V-0
Contact: Phosphor Bronze, 0.64mm (.025") square
Plating: See Table
Operating Temperature: -40 to +105°C

Plating Option	Order No.			
	M = 9.17mm (.361") C = 3.61mm (.142") P = 3.06mm (.120")	M = 9.17mm (.361") C = 3.61mm (.142") P = 3.43mm (.135") Kinked PC Tail	M = 10.29mm (.405") C = 6.30mm (.248") P = 3.06mm (.120")	M = 10.29mm (.405") C = 6.30mm (.248") P = 3.43mm (.135") Kinked PC Tail
Tin	22-28-6XX0	22-28-7XX0	22-28-6XX1	22-28-7XX1
15 μ " select Gold	22-28-6XX2	22-28-7XX2	22-28-6XX3	22-28-7XX3
30 μ " select Gold	22-28-6XX4	22-28-7XX4	22-28-6XX5	22-28-7XX5

Replace XX with no. of circuits, 02-36

Note: Dimension M = Mating End, Dimension C = Mating Height and Dimension P = PC Tail

Circuit 1 designation is used to orient the header to locate the voided circuit. Review mating connector to assure correct mating orientation.

2.54mm (.100") Pitch KK[®] Breakaway Header

42227
Vertical
Friction Lock

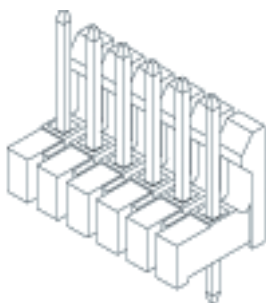

Features and Benefits

- Sizes 2 to 36 circuits
- Available with kinked pins for better PC board retention
- Available with end backwalls removed for left to right polarization
- Various pin lengths available (contact Molex)
- Voids circuits available (contact Molex)

Reference Information

Product Specification: PS-10-07
Packaging: Bag
Tooling Information: See cutting tool section
UL File No.: E29179
CSA File No.: LR19980
Mates With: 2695, 4455, 6471, 7720 and 7880
Designed In: Inches

Electrical

Voltage: 250V
Current: 4.0A
Contact Resistance: 20 milliohms max.
Dielectric Withstanding Voltage: 1500V
Insulation Resistance: 50,000 Megohms min.

Mechanical

Durability: Tin—25 cycles max.
Gold—100 cycles max.

Physical

Housing: Glass-filled nylon, UL 94V-0
Contact: Phosphor Bronze, 0.64mm (.025") square
Plating: See Table
Operating Temperature: -40 to +105°C

Order No.								
Standard			With Kinked Tails			With Backwalls Removed		
Tin	15 μ " Select Gold	30 μ " Select Gold	Tin	15 μ " Select Gold	30 μ " Select Gold	Tin	15 μ " Select Gold	30 μ " Select Gold
22-28-0XX0	22-28-0XX1	22-28-0XX2	22-28-0XX3	22-28-0XX4	22-28-0XX5	22-28-0XX6*	22-28-0XX7*	22-28-0XX8*

Replace XX with no. of circuits, 02-36

* Available in 3 to 36 circuits only

Circuit 1 designation is used to orient the header to locate the voided circuit. Review mating connector to assure correct mating orientation.

2.54mm (.100") Pitch KK[®] Breakaway Header

42228
Right Angle
Friction Lock

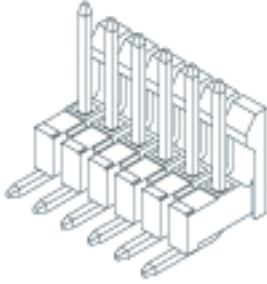

Features and Benefits

- Sizes 2 to 36 circuits
- Available with kinked pins for better PC board retention
- Available with end backwalls removed for left to right polarization
- Various pin lengths available (contact Molex)
- Voided circuits available (contact Molex)

Reference Information

Product Specification: PS-10-07
Packaging: Bag
Tooling Information: See cutting tool section
UL File No.: E29179
CSA File No.: LR19980
Mates With: 2695, 4455, 6471, 7720 and 7880
Designed In: Inches

Electrical

Voltage: 250V
Current: 4.0A
Contact Resistance: 20 milliohms max.
Dielectric Withstanding Voltage: 1500V
Insulation Resistance: 50,000 Megohms min.

Mechanical

Durability: Tin—25 cycles max.
Gold—100 cycles max.

Physical

Housing: Glass-filled nylon, UL 94V-0
Contact: Phosphor Bronze, 0.64mm (.025") square
Plating: See Table
Operating Temperature: -40 to +105°C

Standard			With Kinked Tails			With Backwalls Removed		
Tin	15 μ m Select Gold	30 μ m Select Gold	Tin	15 μ m Select Gold	30 μ m Select Gold	Tin	15 μ m Select Gold	30 μ m Select Gold
22-28-1XX0	22-28-1XX1	22-28-1XX2	22-28-1XX3	22-28-1XX4	22-28-1XX5	22-28-1XX6*	22-28-1XX7*	22-28-1XX8*
Replace XX with no. of circuits, 02-36								

* Available in 3 to 36 circuits only

Circuit 1 designation is used to orient the header to locate the voided circuit. Review mating connector to assure correct mating orientation.

2.54mm (.100") Pitch KK[®] Solid Header

4030
Vertical

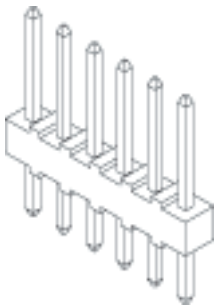

Features and Benefits

- Sizes 2 to 28 circuits
- 4030 with voids is 4380 Series
- Various pin lengths available
- Voided circuits available (contact Molex)

Reference Information

Product Specification: PS-10-07
Packaging: Bag
UL File No.: E29179
CSA File No.: LR19980
Mates With: 2695, 4455, 6471, 7720 and 7880
Designed In: Inches

Electrical

Voltage: 250V
Current: 4.0A
Contact Resistance: 20 milliohms max.
Dielectric Withstanding Voltage: 1500V
Insulation Resistance: 50K Megohms min.

Mechanical

Durability: Tin—25 cycles max.
Gold—100 cycles max.

Physical

Housing: Nylon, UL 94V-0
Contact: Brass, 0.64mm (.025") square
Plating: See Table
Operating Temperature: 0 to +75°C

Circuits	Order No.		Lead-free
	Tin	Gold	
2	22-03-2021	22-10-2021	Yes
3	22-03-2031	22-10-2031	
4	22-03-2041	22-10-2041	
5	22-03-2051	22-10-2051	
6	22-03-2061	22-10-2061	
7	22-03-2071	22-10-2071	
8	22-03-2081	22-10-2081	
9	22-03-2091	22-10-2091	
10	22-03-2101	22-10-2101	

Circuits	Order No.		Lead-free
	Tin	Gold	
11	22-03-2111	22-10-2111	Yes
12	22-03-2121	22-10-2121	
13	22-03-2131	22-10-2131	
14	22-03-2141	22-10-2141	
15	22-03-2151	22-10-2151	
16	22-03-2161	22-10-2161	
17	22-03-2171	22-10-2171	
18	22-03-2181	22-10-2181	
19	22-03-2191	22-10-2191	

Circuits	Order No.		Lead-free
	Tin	Gold	
20	22-03-2201	22-10-2201	Yes
21	22-03-2211	22-10-2211	
22	22-03-2221	22-10-2221	
23	22-03-2231	22-10-2231	
24	22-03-2241	22-10-2241	
25	22-03-2251	22-10-2251	
26	22-03-2261	22-10-2261	
27	22-03-2271	22-10-2271	
28	22-03-2281	22-10-2281	

Note: In the Far East, the polyester product has different Engineering No. and Order No.

Circuit 1 designation is used to orient the header to locate the voided circuit. Review mating connector to assure correct mating orientation.

2.54mm (.100") Pitch KK[®] Solid Header

4094 Right Angle



Circuits	Order No.		Lead-free
	Tin	Gold	
2	22-05-2021	22-12-2021	Yes
3	22-05-2031	22-12-2031	
4	22-05-2041	22-12-2041	
5	22-05-2051	22-12-2051	
6	22-05-2061	22-12-2061	
7	22-05-2071	22-12-2071	
8	22-05-2081	22-12-2081	
9	22-05-2091	22-12-2091	
10	22-05-2101	22-12-2101	

Note: In the Far East the polyester product has different Engineering No. and Order No.

Features and Benefits

- Sizes 2 to 28 circuits
- 4094 with voids is 4494 Series
- Various pin lengths available
- Voided circuits available (contact Molex)

Reference Information

Product Specification: PS-10-07
 Packaging: Bag
 UL File No.: E29179
 CSA File No.: LR19980
 Mates With: 2695, 4455, 6471, 7720 and 7880
 Designed In: Inches

Electrical

Voltage: 250V
 Current: 4.0A
 Contact Resistance: 20 milliohms max.
 Dielectric Withstanding Voltage: 1500V
 Insulation Resistance: 50K Megohms min.

Mechanical

Durability: Tin—25 cycles max.
 Gold—100 cycles max.

Physical

Housing: Nylon, UL 94V-0
 Contact: Brass, 0.64mm (.025") square
 Plating: See Table
 Operating Temperature: 0 to +75°C

Circuits	Order No.		Lead-free
	Tin	Gold	
11	22-05-2111	22-12-2111	Yes
12	22-05-2121	22-12-2121	
13	22-05-2131	22-12-2131	
14	22-05-2141	22-12-2141	
15	22-05-2151	22-12-2151	
16	22-05-2161	22-12-2161	
17	22-05-2171	22-12-2171	
18	22-05-2181	22-12-2181	

Circuits	Order No.		Lead-free
	Tin	Gold	
19	22-05-2191	22-12-2191	Yes
20	22-05-2201	22-12-2201	
21	22-05-2211	22-12-2211	
22	22-05-2221	22-12-2221	
23	22-05-2231	22-12-2231	
24	22-05-2241	22-12-2241	
25	22-05-2251	22-12-2251	
28	22-05-2281	22-12-2281	

2.54mm (.100") Pitch KK[®] Solid Header

6373 Vertical, Friction Lock

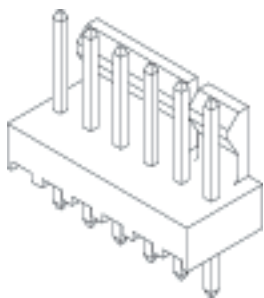

Circuits	Order No.		Lead-free
	Tin	Gold	
2	22-23-2021	22-11-2022	Yes
3	22-23-2031	22-11-2032	
4	22-23-2041	22-11-2042	
5	22-23-2051	22-11-2052	
6	22-23-2061	22-11-2062	
7	22-23-2071	22-11-2072	
8	22-23-2081	22-11-2082	
9	22-23-2091	22-11-2092	
10	22-23-2101	22-11-2102	

Note: Circuit 1 designation is used to orient the header to locate the voided circuit. Review mating connector to assure correct mating orientation.

Features and Benefits

- Sizes 2 to 28 circuits
- Friction lock provides passive lock to connector with ramp
- Good in high vibration applications
- Various pin lengths available
- Voided circuits available (contact Molex)

Reference Information

Product Specification: PS-10-07
 Packaging: Bag
 UL File No.: E29179
 CSA File No.: LR19980
 Mates With: 2695, 4455, 6471, 7720 and 7880
 Designed In: Inches

Electrical

Voltage: 250V
 Current: 4.0A
 Contact Resistance: 20 milliohms max.
 Dielectric Withstanding Voltage: 1500V
 Insulation Resistance: 50K Megohms min.

Mechanical

Durability: Tin—25 cycles max.
 Gold—100 cycles max.

Physical

Housing: Nylon, UL 94V-0
 Contact: Brass, 0.64mm (.025") square
 Plating: See Table
 Operating Temperature: 0 to +75°C

Circuits	Order No.		Lead-free
	Tin	Gold	
11	22-23-2111	22-11-2112	Yes
12	22-23-2121	22-11-2122	
13	22-23-2131	22-11-2132	
14	22-23-2141	22-11-2142	
15	22-23-2151	22-11-2152	
16	22-23-2161	22-11-2162	
17	22-23-2171	22-11-2172	
18	22-23-2181	22-11-2182	
19	22-23-2191	22-11-2192	

Circuits	Order No.		Lead-free
	Tin	Gold	
20	22-23-2201	22-11-2202	Yes
21	22-23-2211	22-11-2212	
22	22-23-2221	22-11-2222	
23	22-23-2231	22-11-2232	
24	22-23-2241	22-11-2242	
25	22-23-2251	22-11-2252	
26	22-23-2261	22-11-2262	
27	22-23-2271	22-11-2272	
28	22-23-2281	22-11-2282	

2.54mm (.100") Pitch KK[®] Header

6410 Vertical Friction Lock

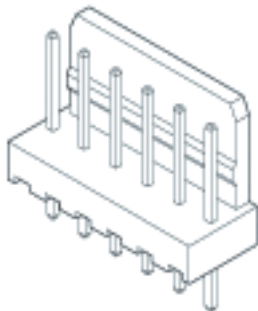

Features and Benefits

- Sizes 2 to 28 circuits
- Friction lock provides passive lock to connector with ramp
- Good in high vibration applications
- Higher backwall than the 6373 Series
- Various pin lengths available

Reference Information

Product Specification: PS-10-07
 Packaging: Bag
 UL File No.: E29179
 CSA File No.: LR19980
 Mates With: 2695 with locking ramp, 6471 and 7880
 Designed In: Inches

Electrical

Voltage: 250V
 Current: 4.0A
 Contact Resistance: 20 milliohms max.
 Dielectric Withstanding Voltage: 1500V
 Insulation Resistance: 50K Megohms min.

Physical

Housing: Nylon, UL 94V-0
 Contact: Brass, 0.64mm (.025") square
 Plating: See Table
 Operating Temperature: 0 to +75°C

Circuits	Order No.		Lead-free
	Tin	Gold	
2	22-27-2021	22-29-2021	Yes
3	22-27-2031	22-29-2031	
4	22-27-2041	22-29-2041	
5	22-27-2051	22-29-2051	
6	22-27-2061	22-29-2061	
7	22-27-2071	22-29-2071	
8	22-27-2081	22-29-2081	
9	22-27-2091	22-29-2091	
10	22-27-2101	22-29-2101	

Circuits	Order No.		Lead-free
	Tin	Gold	
11	22-27-2111	22-29-2111	Yes
12	22-27-2121	22-29-2121	
13	22-27-2131	22-29-2131	
14	22-27-2141	22-29-2141	
15	22-27-2151	22-29-2151	
16	22-27-2161	22-29-2161	
17	22-27-2171	22-29-2171	
18	22-27-2181	22-29-2181	
19	22-27-2191	22-29-2191	

Circuits	Order No.		Lead-free
	Tin	Gold	
20	22-27-2201	22-29-2201	Yes
21	22-27-2211	22-29-2211	
22	22-27-2221	22-29-2221	
23	22-27-2231	22-29-2231	
24	22-27-2241	22-29-2241	
25	22-27-2251	22-29-2251	
26	22-27-2261	22-29-2261	
27	22-27-2271	22-29-2271	
28	22-27-2281	22-29-2281	

2.54mm (.100") Pitch KK[®] Solid Header

7478 Right Angle, Friction Lock

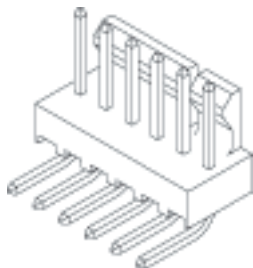

Features and Benefits

- Sizes 2 to 28 circuits
- Friction lock provides passive lock to connector with ramp
- 7478 with voids is 7832 Series
- Various pin lengths available
- End-to-end stackable
- Edge mount only

Reference Information

Product Specification: PS-10-07
 Packaging: Bag
 UL File No.: E29179
 CSA File No.: LR19980
 Mates With: 2695, 4455, 6471, 7720 and 7880
 Designed In: Inches

Electrical

Voltage: 250V
 Current: 4.0A
 Contact Resistance: 20 milliohms max.
 Dielectric Withstanding Voltage: 1500V
 Insulation Resistance: 50K Megohms min.

Mechanical

Durability: Tin—25 cycles max.
 Gold—100 cycles max.

Physical

Housing: Nylon, UL 94V-0
 Contact: Brass, 0.64mm (.025") square
 Plating: See Table
 Operating Temperature: 0 to +75°C

Circuits	Order No.		Lead-free
	Tin	Gold	
2	22-05-3021	22-12-2024	Yes
3	22-05-3031	22-12-2034	
4	22-05-3041	22-12-2044	
5	22-05-3051	22-12-2054	
6	22-05-3061	22-12-2064	
7	22-05-3071	22-12-2074	
8	22-05-3081	22-12-2084	
9	22-05-3091	22-12-2094	
10	22-05-3101	22-12-2104	

Circuits	Order No.		Lead-free
	Tin	Gold	
11	22-05-3111	22-12-2114	Yes
12	22-05-3121	22-12-2124	
13	22-05-3131	22-12-2134	
14	22-05-3141	22-12-2144	
15	22-05-3151	22-12-2154	
16	22-05-3161	22-12-2164	
17	22-05-3171	22-12-2174	
18	22-05-3181	22-12-2184	
19	22-05-3191	22-12-2194	

Circuits	Order No.		Lead-free
	Tin	Gold	
20	22-05-3201	22-12-2204	Yes
21	22-05-3211	22-12-2214	
22	22-05-3221	22-12-2224	
23	22-05-3231	22-12-2234	
24	22-05-3241	22-12-2244	
25	22-05-3251	22-12-2254	
26	22-05-3261	22-12-2264	
27	22-05-3271	22-12-2274	
28	22-05-3281	22-12-2284	

Note: Circuit 1 designation is used to orient the header to locate the voided circuit. Review mating connector to assure correct mating orientation.

2.54mm (.100") Pitch KK® Header

7395

Right Angle, Square Pin
Friction Lock

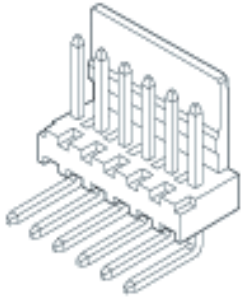

Circuits	Order No.		Lead-free
	Tin	Gold	
2	22-05-7028	22-12-4022	Yes
3	22-05-7038	22-12-4032	
4	22-05-7048	22-12-4042	
5	22-05-7058	22-12-4052	
6	22-05-7068	22-12-4062	
7	22-05-7078	22-12-4072	
8	22-05-7088	22-12-4082	
9	22-05-7098	22-12-4092	
10	22-05-7108	22-12-4102	

Features and Benefits

- Sizes 2 to 28 circuits
- Edge mount only

Reference Information

Mates With: 2695, 6471 and 7720S
Designed In: Inches

Physical

Housing: Natural nylon, UL 94V-0
Contact: Brass, 0.64mm (.025") square
Plating: Tin or Gold
Operating Temperature: 0 to +75°C

2.54mm (.100") Pitch PCB and Wire Connectors

2.54mm (.100") Pitch KK® PC Board Connector

4455

Right Angle

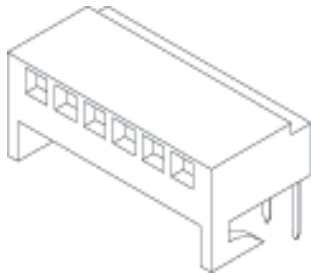

Features and Benefits

- Sizes 2 to 25 circuits
- End-to-end stackable
- See 44812 Series for high temperature version
- Thicker board hooks available

Reference Information

Product Specification: PS-10-07
Packaging: Tray
UL File No.: E29179
CSA File No.: LR19980
Mates With: 4030, 4094, 4380, 42152, 42153, 42375,
42376 and 42377 headers and .025" square pins
Designed In: Inches

Electrical

Voltage: 250V
Current: 2.5A max.*
Contact Resistance: 20 milliohms max.
Dielectric Withstanding Voltage: 1500V AC
Insulation Resistance: 500K Megohms min.

Mechanical

Mating Force: 199g max.
Unmating Force: 57g min.

Physical

Housing: Nylon, UL 94V-0
Contact: Brass (contact Molex for Phosphor Bronze)
Plating: See Table
Operating Temperature: 0 to +75°C

Circuits	Order No.			Lead-free
	Tin	Gold	Select Gold	
2	22-15-2026	22-16-2021	22-16-2020	Yes
3	22-15-2036	22-16-2031	22-16-2030	
4	22-15-2046	22-16-2041	22-16-2040	
5	22-15-2056	22-16-2051	22-16-2050	
6	22-15-2066	22-16-2061	22-16-2060	
7	22-15-2076	22-16-2071	22-16-2070	
8	22-15-2086	22-16-2081	22-16-2080	
9	22-15-2096	22-16-2091	22-16-2090	
10	22-15-2106	22-16-2101	22-16-2100	
11	22-15-2116	22-16-2111	22-16-2110	
12	22-15-2126	22-16-2121	22-16-2120	
13	22-15-2136	22-16-2131	22-16-2130	

Circuits	Order No.			Lead-free
	Tin	Gold	Select Gold	
14	22-15-2146	22-16-2141	22-16-2140	Yes
15	22-15-2156	22-16-2151	22-16-2150	
16	22-15-2166	22-16-2161	22-16-2160	
17	22-15-2176	22-16-2171	22-16-2170	
18	22-15-2186	22-16-2181	22-16-2180	
19	22-15-2196	22-16-2191	22-16-2190	
20	22-15-2206	22-16-2201	22-16-2200	
21	22-15-2216	22-16-2211	22-16-2210	
22	22-15-2226	22-16-2221	22-16-2220	
23	22-15-2236	22-16-2231	22-16-2230	
24	22-15-2246	22-16-2241	22-16-2240	
25	22-15-2256	22-16-2251	22-16-2250	

* Current rating is dependent upon PCB traces, Copper weight, solder, etc. (contact Molex for more information)

	Order No.
Polarizing Key 4161-1	15-04-9209

2.54mm (.100") Pitch KK® PC Board Connector

4455
Top Entry

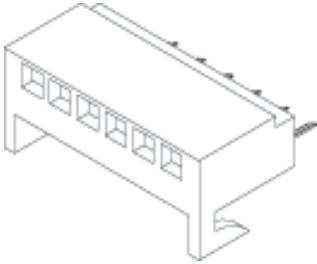

Features and Benefits

- Sizes 2 to 25 circuits
- End-to-end stackable
- Also available without board hooks (see table below)
- See 44812 Series for high temperature version
- Thicker board hooks available

Reference Information

Product Specification: PS-10-07
 Packaging: Tray
 UL File No.: E29179
 CSA File No.: LR19980
 Mates With: 4030, 4094, 42152, 42153, 42375, 42376, 42377, 70021 and 70475 headers and .025" square pins (edge mount only)
 Designed In: Inches

Electrical

Voltage: 250V
 Current: 2.5A max.*
 Contact Resistance: 20 milliohms max.
 Dielectric Withstanding Voltage: 1500V AC
 Insulation Resistance: 50K Megohms min.

Mechanical

Contact Retention to Housing: 3.63kg (8 lb) min.
 Mating Force: 199g max.
 Unmating Force: 57g min.
 Normal Force: 300g average

Physical

Housing: Nylon, UL 94V-0
 Contact: Brass (contact Molex for Phosphor Bronze)
 Plating: See Table
 Operating Temperature: 0 to +75°C

Circuits	Order No.				Lead-free
	Tin		Gold	Select Gold	
	With Hooks	Without Hooks	With Hooks	With Hooks	
2	22-02-2025	22-02-7023	22-18-2023	22-18-2021	Yes
3	22-02-2035	22-02-7033	22-18-2033	22-18-2031	
4	22-02-2045	22-02-7043	22-18-2043	22-18-2041	
5	22-02-2055	22-02-7053	22-18-2053	22-18-2051	
6	22-02-2065	22-02-7063	22-18-2063	22-18-2061	
7	22-02-2075	22-02-7073	22-18-2073	22-18-2071	
8	22-02-2085	22-02-7083	22-18-2083	22-18-2081	
9	22-02-2095	22-02-7093	22-18-2093	22-18-2091	
10	22-02-2105	22-02-7103	22-18-2103	22-18-2101	
11	22-02-2115	22-02-7113	22-18-2113	22-18-2111	
12	22-02-2125	22-02-7123	22-18-2123	22-18-2121	
13	22-02-2135	22-02-7133	22-18-2133	22-18-2131	

Circuits	Order No.				Lead-free
	Tin		Gold	Select Gold	
	With Hooks	Without Hooks	With Hooks	With Hooks	
15	22-02-2155	22-02-7153	22-18-2153	22-18-2151	Yes
16	22-02-2165	22-02-7163	22-18-2163	22-18-2161	
17	22-02-2175	22-02-7173	22-18-2173	22-18-2171	
18	22-02-2185	22-02-7183	22-18-2183	22-18-2181	
19	22-02-2195	22-02-7193	22-18-2193	22-18-2191	
20	22-02-2205	22-02-7203	22-18-2203	22-18-2201	
21	22-02-2215	22-02-7213	22-18-2213	22-18-2211	
22	22-02-2225	22-02-7223	22-18-2223	22-18-2221	
23	22-02-2235	22-02-7233	22-18-2233	22-18-2231	
24	22-02-2245	22-02-7243	22-18-2243	22-18-2241	
25	22-02-2255	22-02-7253	22-18-2253	22-18-2251	

* Current rating is dependent upon PCB traces, Copper weight, solder, etc. (contact Molex for more information)

	Order No.
Polarizing Key 4161-1	15-04-9209

2.54mm (.100") Pitch KK® PC Board Connector

4455
Bottom Entry

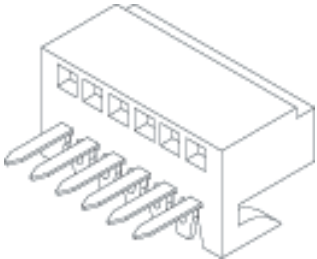

Features and Benefits

- Sizes 2 to 25 circuits
- End-to-end stackable
- Mating header must be long enough to accommodate board thickness
- See 42625 Series for high temperature version
- Thicker board hooks available

Reference Information

Product Specification: PS-10-07
 Packaging: Tray
 UL File No.: E29179
 CSA File No.: LR19980
 Mates With: 4030, 4094, 4380, 42152, 42153, 42375, 42376 and 42377 headers and .025" square pins
 Designed In: Inches

Electrical

Voltage: 250V
 Current: 2.5A max.*
 Contact Resistance: 20 milliohms max.
 Dielectric Withstanding Voltage: 1500V AC
 Insulation Resistance: 500K Megohms min.

Mechanical

Mating Force: 199g max.
 Unmating Force: 57g min.

Physical

Housing: Nylon, UL 94V-0
 Contact: Brass (contact Molex for Phosphor Bronze)
 Plating: See Table
 Operating Temperature: 0 to +75°C

Circuits	Order No.			Lead-free
	Tin	Gold	Select Gold	
	2	22-14-2024	22-17-2022	
3	22-14-2034	22-17-2032	22-17-3032	
4	22-14-2044	22-17-2042	22-17-3042	
5	22-14-2054	22-17-2052	22-17-3052	
6	22-14-2064	22-17-2062	22-17-3062	
7	22-14-2074	22-17-2072	22-17-3072	
8	22-14-2084	22-17-2082	22-17-3082	
9	22-14-2094	22-17-2092	22-17-3092	
10	22-14-2104	22-17-2102	22-17-3102	
11	22-14-2114	22-17-2112	22-17-3112	
12	22-14-2124	22-17-2122	22-17-3122	
13	22-14-2134	22-17-2132	22-17-3132	

Circuits	Order No.			Lead-free
	Tin	Gold	Select Gold	
	14	22-14-2144	22-17-2142	
15	22-14-2154	22-17-2152	22-17-3152	
16	22-14-2164	22-17-2162	22-17-3162	
17	22-14-2174	22-17-2172	22-17-3172	
18	22-14-2184	22-17-2182	22-17-3182	
19	22-14-2194	22-17-2192	22-17-3192	
20	22-14-2204	22-17-2202	22-17-3202	
21	22-14-2214	22-17-2212	22-17-3212	
22	22-14-2224	22-17-2222	22-17-3222	
23	22-14-2234	22-17-2232	22-17-3232	
24	22-14-2244	22-17-2242	22-17-3242	
25	22-14-2254	22-17-2252	22-17-3252	

* Current rating is dependent upon PCB traces, Copper weight, solder, etc. (contact Molex for more information)

2.54mm (.100") Pitch KK[®] PC Board Connector

4455
With Cat Ear Terminals

Preferred Version in Europe and the Far East

Right Angle



These assemblies are the same as 4455A, B and C versions, except these have higher pressure cat ear contacts on the Bronze terminals.

Reference Information

Product Specification: PS-10-07
Packaging: Tray
UL File No.: E29179
CSA File No.: LR19980
Mates With: 4030, 4094, 70021 and 70475
Designed In: Inches

Electrical

Voltage: 250V
Current: 2.5A
Contact Resistance: 20 milliohms max.
Dielectric Withstanding Voltage: 1500V
Insulation Resistance: 500K Megohms min.

Mechanical

Contact Retention to Housing: 27.21g min.
Mating Force: 199g max.
Unmating Force: 57g min.
Normal Force: 300g
Durability: 25 cycles

Physical

Housing: Nylon, UL 94V-0
Contact: Phosphor Bronze
Plating: Hot Tin/Lead dip—1mm min.
Operating Temperature: 0 to +75°C

Circuits	Order No.	Lead-free
2	38-00-1332	Yes
3	38-00-1333	
4	38-00-1334	
5	38-00-1335	
6	38-00-1336	
7	38-00-1337	
8	38-00-1338	
9	38-00-1339	
10	38-00-1340	
11	38-00-1341	
12	38-00-1342	
13	38-00-1343	

Circuits	Order No.	Lead-free
14	38-00-1344	Yes
15	38-00-1345	
16	38-00-1346	
17	38-00-1347	
18	38-00-1348	
19	38-00-1349	
20	38-00-1350	
21	38-00-1351	
22	38-00-1352	
23	38-00-1353	
24	38-00-1354	
25	38-00-1355	

Bottom Entry

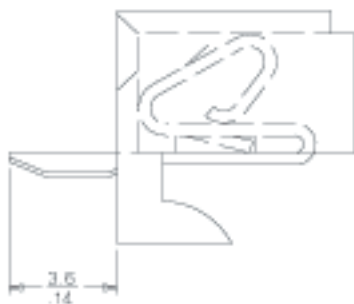

Circuits	Order No.	Lead-free
2	38-00-1392	Yes
3	38-00-1393	
4	38-00-1394	
5	38-00-1395	
6	38-00-1396	
7	38-00-1397	
8	38-00-1398	
9	38-00-1399	
10	38-00-1400	
11	38-00-1401	
12	38-00-1402	
13	38-00-1403	

Circuits	Order No.	Lead-free
14	38-00-1404	Yes
15	38-00-1405	
16	38-00-1406	
17	38-00-1407	
18	38-00-1408	
19	38-00-1409	
20	38-00-1410	
21	38-00-1411	
22	38-00-1412	
23	38-00-1413	
24	38-00-1414	
25	38-00-1415	

Top Entry



Circuits	Order No.	Lead-free
2	38-00-1422	Yes
3	38-00-1423	
4	38-00-1424	
5	38-00-1425	
6	38-00-1426	
7	38-00-1427	
8	38-00-1428	
9	38-00-1429	
10	38-00-1430	
11	38-00-1431	
12	38-00-1432	
13	38-00-1433	

Circuits	Order No.	Lead-free
14	38-00-1434	Yes
15	38-00-1435	
16	38-00-1436	
17	38-00-1437	
18	38-00-1438	
19	38-00-1439	
20	38-00-1440	
21	38-00-1441	
22	38-00-1442	
23	38-00-1443	
24	38-00-1444	
25	38-00-1445	

2.54mm (.100") Pitch Single Row Custom Headers

Features and Benefits

- Sizes 2 to 36 circuits
- Optional voided pin version for polarization to the mating part available
- Optional kinked PC tail versions are available for through hole and right angle versions
- Pick-and-place cap versions available
- Tape and reel packaging option available

Reference Information



Product Specification: PS-87920-019
 Packaging: Tray, tube or bag
 Mates With: KK 2.54mm receptacles
 Designed In: Millimeters

Electrical

Voltage: 250V
 Current: 3.0A
 Contact Resistance: 20 milliohms max.
 Dielectric Withstanding Voltage: 500V
 Insulation Resistance: 1000 Megohms min.

Physical

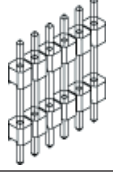
Housing: Glass-filled nylon, UL94V-0
 Contact: Copper Alloy, 0.64mm square
 Plating: Tin, Gold Flash, 10 μ " Select Gold, 15 μ " Select Gold, and 30 μ " Select Gold
 Operating Temperature: -55 to +105°C

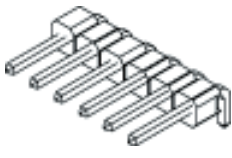
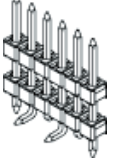
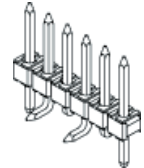
Single Body Options		Series	Dual Body Options		Series
	Vertical Through Hole	87891		Vertical Through Hole	87937
	Vertical SMT	87898		Vertical SMT	87938
	Right Angle Through Hole	87897		Vertical SMT with Through Hole Pins	68372
	Through Hole Pins	68370			

2.54mm (.100") Pitch Dual Row Custom Headers

Features and Benefits

- Sizes 4 to 80 circuits
- Optional voided pin version for polarization to the mating part available
- Optional kinked PC tail versions are available for through hole and right angle versions
- Available with and without locating pegs
- Pick-and-place cap versions available

Reference Information

Product Specification: PS-87920-019
 Packaging: Tray, tube or bag
 Mates With: C-Grid 2.54mm Receptacles
 Designed In: Millimeters

Electrical

Voltage: 250V
 Current: 3.0A
 Contact Resistance: 20 milliohms max.
 Dielectric Withstanding Voltage: 500V
 Insulation Resistance: 1000 Megohms min.



Physical

Housing: Black high-temperature polyester, UL94V-0
 Contact: Copper Alloy, 0.64mm square
 Plating: Tin, Gold Flash, 10µ" Select Gold, 15µ" Select Gold,
 and 30µ" Select Gold
 Operating Temperature: -55 to +105°C

2.54mm (.100") Pitch PCB and Wire Connectors

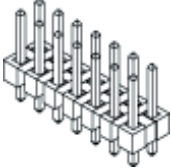
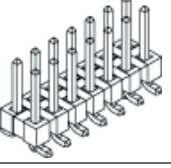
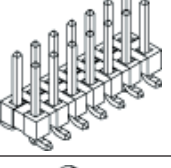
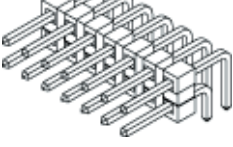

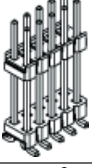
	Dual Body Options	Series
	Vertical Through Hole	87914
	Vertical SMT	87920
	Vertical SMT with pegs	87920
	Right Angle Through Hole	87911

	Dual Body Options	Series
	Vertical Through Hole	87797
	Vertical SMT	87939
	Vertical SMT with pegs	87939

2.54mm (.100") Pitch Pogo Pin Connector

47245

**Vertical, Surface Mount
With Cap**

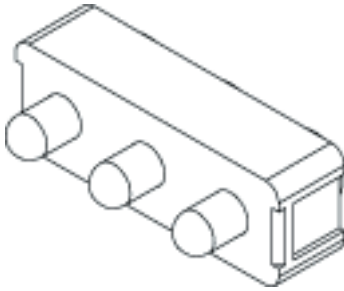

Circuits	Order No.	Lead-free
3	47245-0001	Yes

Features and Benefits

- Speaker, battery, vibrator or antenna contact applications
- Small footprint saves PCB real estate and provides more flexible design
- SMT lead-free configuration
- Initial height at 4.15mm (.163") and full-stroke working height at 3.15mm (.124")

Reference Information

Product Specification: PS-47245-001

Packaging: Tape on reel

Designed In: Millimeters

Electrical

Voltage: 60V DC

Current: 1.5A

Contact Resistance: 30 milliohms max.

Dielectric Withstanding Voltage: 500V DC

Insulation Resistance: 100 Megohms min.

Mechanical

Normal Force: 0.44N

Durability: 20,000 cycles

Physical

Housing: PA Polyamide (nylon) 4/6, UL 94V-0

Contact: Copper Alloy

Plating: Contact Area—4μ" Gold

Solder Tail Area—4μ" Gold

Underplating: Nickel

Operating Temperature: -40 to +85°C

C

2.54mm (.100") Pitch PCB and Wire Connectors