

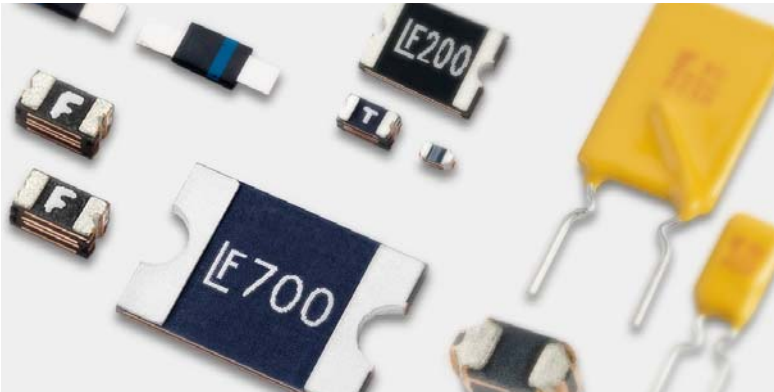

Expertise Applied | Answers Delivered



PRODUCT
CATALOG
& DESIGN
GUIDE



PTC

**Positive Temperature Coefficient
(PTC) Thermistor Products**

TABLE OF CONTENTS

PTC Characteristics and Terms
PTC Applications & Typical PTC Circuit Protection Design
PTC Selection Worksheet
Legal Disclaimers

Series Name	Image	Chip Size	Hold Current (I _{Hold})	Max Voltage (V _{Max})	Max Fault Current (I _{Max})	Operating Temperature Range	Agency Approval		RoHS Compliant	Lead Free
							UL	TUV		
LoRho Surface Mount PTCs										
LoRho		0402 (1005)	0.1 - 0.5 A	6 V	40 - 50 A	-40°C to 85°C	•	•	•	•
		0603 (1608)	0.5 - 1.75 A	6 V	50 A		•	•	•	•
		0805 (2012)	0.75 - 3.0 A	6 V	50 A		•	•	•	•
		1206 (3216)	0.75 - 4.5 A	6 - 12 V	50 A		•	•	•	•
		1210 (3225)	1.75 - 4.5 A	6 V	50 A		•	•	•	•
		1812 (4532)	1.9 - 3.7 A	6 V	50 A		•	•	•	•
		2920 (7351)	7.0 A	6 V	50 A		•	•	•	•
Surface Mount PTCs										
0402L		0402 (1005)	0.1 - 0.5 A	6 V	40 - 50 A	-40°C to 85°C	•	•	•	•
0603L		0603 (1608)	0.04 - 0.5 A	6 - 24 V	20 - 40 A		•	•	•	•
0805L		0805 (2012)	0.1 - 1.1 A	6 - 24 V	40 - 100 A		•	•	•	•
1206L		1206 (3216)	0.125 - 2 A	6 - 30 V	100 A		•	•	•	•
1210L		1210 (3225)	0.05 - 2 A	6 - 30 V	10 - 100 A		•	•	•	•
1812L		1812 (4532)	0.1 - 2 A	6 - 60 V	10 - 100 A		•	•	•	•
2016L		2016 (5041)	0.3 - 2.0 A	6 - 60 V	20 - 40 A		•	•	•	•
2920L		2920 (7351)	0.3 - 5.0 A	6 - 60 V	10 - 40 A		•	•	•	•
250S		250S	0.13 A	250 V	3A		•	•	•	•
Radial Leaded PTCs										
USBR		N/A	0.75 - 2.5 A	6 - 16 V	40A	-40°C to 85°C	•	•	•	•
16R			2.5 - 14 A	16V	100 A		•	•	•	•
30R			0.9 - 9 A	30V	40A		•	•	•	•
60R			0.1 - 3.75 A	60V	40A		•	•	•	•
72R			0.2 - 3.75 A	72V	40A		•	•	•	•
135R			0.05 - 3.75 A	135V	1 - 20 A		•	•	•	•
250R			0.08 - 0.18 A	250V	3 - 10 A		•	•	•	•
265R			0.05 - 2.0 A	265V	1 - 20 A		•	•	•	•
600R			0.15 - 0.16A	600 V	3A		•	•	•	•
Battery Strap PTCs										
SL		N/A	1.9 - 3.7 A	6 V	50A	-40°C to 85°C	•	•	•	•
LR			2.6 - 7.3 A	15 - 20 V	100A		•	•	•	•
LT			1.0 A	24 V	100A		•	•	•	•
ST			1.75 A	15 V	100A		•	•	•	•
VL			1.75 A	12 V	100A		•	•	•	•
VT			2.1 A	16 V	100A		•	•	•	•

© 2017 Littelfuse, Inc.
Specifications, descriptions and illustrative material in this literature are as accurate as known at the time of publication, but are subject to change without notice. Visit www.littelfuse.com for more information.

PTC Characteristics and Terms

Overcurrent circuit protection can be accomplished with the use of either a traditional fuse or PTC (positive temperature coefficient) device.

PTCs are typically used in a wide variety of telecom, computer, consumer electronics, battery and medical electronics product applications where overcurrent events are common and automatic resetability desired.

Littelfuse offers PTCs with the following general forms and features, and come in a variety of sizes and capacities:

Surface Mount Devices:

- A full range of compact footprints from 0402 to 2920
- Hold current ratings from 0.035A to 7.0A
- Voltage ratings from 6V to 60V
- Very fast trip time
- Low resistance down to 7 mΩ (R1max)

Radial Leaded Series:

- Hold current ratings from 0.1A to 14.0A
- Voltage ratings from 6V to 72V
- Low trip-to-hold current ratio
- Low resistance

Battery Strap Devices:

- Narrow and low profile design for high application flexibility
- Weldable band nickel terminal for automated assembly
- Low resistance for extended battery run time

If your application requirements fall outside of our product range, in certain instances we can offer customized

solutions. Please contact Littelfuse for more information.

Traditional Fuses Vs. PTCs

Fuses and PTCs are both overcurrent protection devices, though each offer their own unique operating characteristics and benefits. Understanding the differences between the two technologies should make the choice in selection easier, depending on the application.

The most obvious difference is that PTCs are automatically resettable whereas traditional Fuses need to be replaced after they are tripped. Whereas a fuse will completely stop the flow of current (which may be desired in critical applications) after most similar overcurrent event, PTCs continue to enable the equipment to function, except in extreme cases.

Because they reset automatically, many circuit designers choose PTCs in instances where overcurrent events are expected to occur often, and where maintaining low warranty and service costs, constant system uptime, and/or user transparency are at a premium. They are also often chosen in circuits that are difficult to access or in remote locations, where fuse replacement would be difficult.

There are several other operating characteristics to be considered that distinguish PTCs and fuses, and it is also best to test and verify device performance before use within the end application.

Littelfuse PTC Characteristics

Both Polymeric (Positive Temperature Coefficient) PTC and traditional Fuse devices react to heat generated by the excessive current flow in a circuit. A fuse melts open, interrupting the current flow whereas a PTC limits current flow as it rises in temperature, changing from low to high resistance state. In both cases this condition is called "tripping." The graph at right shows the typical response of a PTC to temperature.

Littelfuse Polymer PTCs are made chiefly of high density polyethylene mixed with graphite. During an overcurrent event, a Polymer PTC will heat and expand, which in turn causes the conducting particles to break contact and stop the current.

The general procedure for resetting the device after an overload has occurred is to remove power and allow the device to cool down.

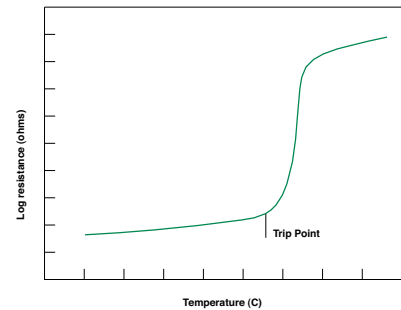

PTC Characteristics and Terms (continued)

Leakage Current: When a PTC is in a "tripped state" it protects the circuitry by limiting the current flow to a low leakage level. Leakage current can range from less than a hundred milliamps (mA) at rated voltage up to a few hundred milliamps (mA) at lower voltages. Fuses on the other hand completely interrupt the current flow when tripped, and this open circuit results in no leakage current when subjected to an overload current.

Interrupting Rating: PTCs are rated for a maximum short circuit current at rated voltage also known as "breaking capacity" or I_{max}. This fault current level is the maximum current that the device can withstand safely, keeping in mind that the PTC will not actually interrupt the current flow (see Leakage Current above). A typical Littelfuse PTC short circuit rating is 40A; or for the battery strap PTCs, this value can reach 100A. Fuses do in fact interrupt the current flow in response to the overload and the range of interrupting ratings, vary from tens of amperes (A) up to 10,000 (A) amperes at rated voltage.

Operating Voltage Rating: General use Littelfuse PTCs are not rated above 60V while fuses are rated up to 600V.

Hold Current Rating: The hold (operating) current rating for PTCs can be up to 14A, while the maximum level for fuses can exceed 30A.

Resistance: Reviewing product specifications indicates that similarly rated PTCs have about twice (sometimes more) the resistance of fuses.

Agency Approvals: Littelfuse PTCs are Recognized under the Component Program of Underwriters Laboratories to UL Standard 1434 for Thermistors. The devices have also been certified under the CSA Component Acceptance Program.

Time-Current Characteristic: Comparing the time-current curves of PTCs to time-current curves of fuses show that the speed of response for a PTC is similar to the time delay of a Littelfuse Slo-Blo® fuse.

Temperature Rerating: The useful upper limit for a PTC is generally 85°C, while the maximum operating temperature for fuses is 125°C.

Ambient temperature effects are in addition to the normal rerating. PTCs hold and trip rating must be rerated when applied at conditions other than room ambient. For example, any rise in ambient temperature will decrease the hold current rating as well as the trip current. A reduction in ambient temperature will increase the trip current as well as the hold current.

The temperature rerating curves in the table below compare PTCs to fuses and illustrate that more rerating is required for a PTC at a given temperature.

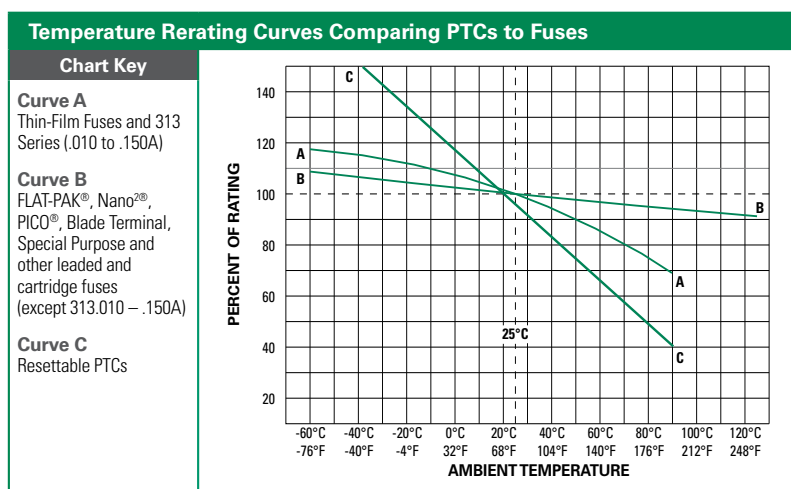

PTC Product Applications

PTCs are typically used as circuit protection in applications where sensitive components are at constant risk of damage from overcurrent conditions. The ability of PTCs to reset themselves after exposure to a fault current makes them ideal within circuits that are not easily accessible to a user or technician or where constant uptime is required.

Typical applications include port protection on personal computers (USB, memory card reader, keyboard/mouse and video ports), peripherals (hard drives, video cards, and hubs), cell phone, battery packs, industrial controls, lighting ballast and motor controls.

The chart below is meant as a quick guide in narrowing to a Littelfuse PTC device that may be appropriate to certain end applications.

For detailed application assistance please contact a Littelfuse product specialist or visit our new reference design center at <http://www.littelfuse.com/designcenter>.

For detailed product specifications, please consult the Littelfuse PTC datasheets within this catalog or visit <http://www.littelfuse.com/PTCs>.

Series Name	SURFACE MOUNT									RADIAL LEADED						BATTERY STRAP						
	LoRho	0603L	0805L	1206L	1210L	1812L	2016L	2920L	250S	USBR	16R	30R	60R	72R	250R	600R	LR	LR	LT	ST	VL	VT
Telecom																						
Application																						
UL60950 ,TIA-968-A, GR-1089 Req's									X						X	X						
ITU-T Recommendations									X						X	X						
CPE (Customer Premises Equipment)									X						X	X						
Analog Line Card									X						X	X						
T1/E1/J1 And xDSL									X						X	X						
ISDN And Ethernet LAN									X						X	X						
Cable Telephony And Modem									X						X	X						
PBX/KTS And Key Telephone System									X						X	X						
Computer and Peripheral																						
USB Port and USB Powered Device	X	X	X	X	X	X				X	X											
I/O Port	X			X	X	X	X	X		X	X	X	X	X								
Video Port				X	X	X		X		X	X											
Memory Card and Socket	X	X	X	X	X	X		X		X	X											
LCD Monitor	X	X	X	X	X	X				X	X											
Hard Disk Drive and Solid State Drive	X	X	X	X	X	X		X		X	X											
Set Top Box				X	X	X		X														
Consumer Electronics																						
Loudspeaker												X										
Smart Phone and Tablet PC	X	X	X	X	X																	
Portable/Wearable Electronic Device	X	X	X	X	X	X	X															
Electromagnetic Loads, Motor								X	X			X	X	X								
Solenoid Protection						X		X				X	X	X								
Battery																						
Lithium-Ion Cell																	X	X	X	X	X	X
Battery Pack and Battery Management System	X																X	X	X	X	X	X
Industrial and Medical Electronics																						
Motor / Fan / Pump / Solenoid						X	X	X				X	X	X								
Voltage / Current Input Terminal				X	X	X			X	X												
Automotive																						
DC Motor / Window Lift											X	X										
Network/Communication/ Infotainment		X	X	X	X	X		X														

NOTE: The application summary is for reference only. Determination of suitability for a specific application is the responsibility of the customer.

Typical PTC Circuit Protection Designs

The following are examples of typical circuits using Littelfuse PTCs in combination with other Littelfuse circuit protection devices to provide a comprehensive protection solution. Contact a Littelfuse application expert for design

assistance or visit www.littelfuse.com/designcenter or <http://www.littelfuse.com/PTCs> for additional information. Be sure to to verify specifications and test device performance before use in the end application.

POWER OVER ETHERNET

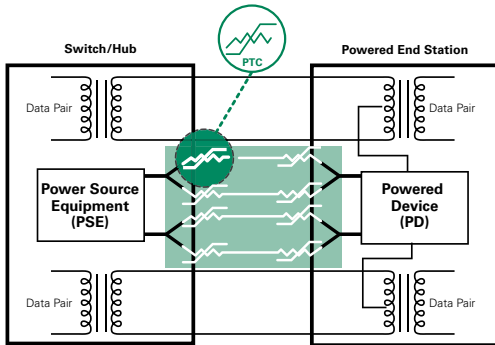

LI-ION BATTERY PACK

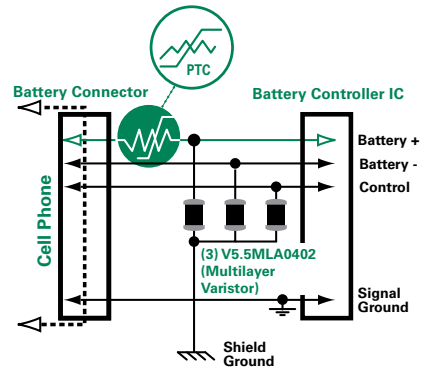

USB 3.0/3.1

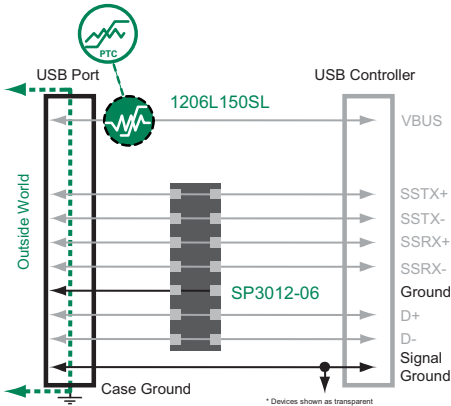

USB 2.0

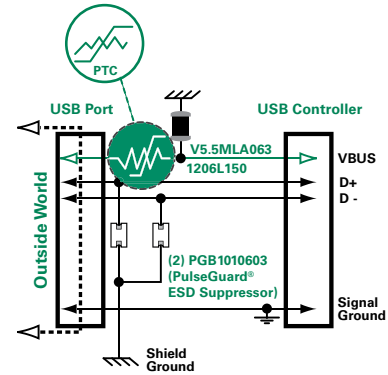

HDMI

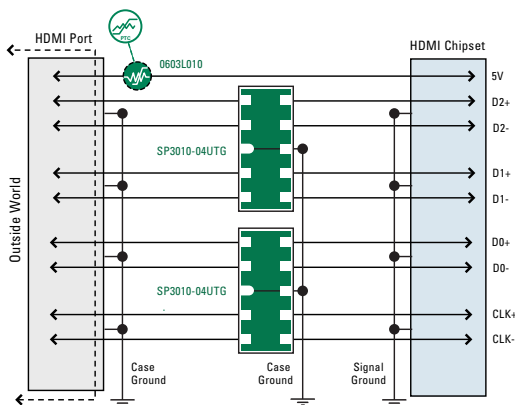

TIP/RING CIRCUIT - METALLIC

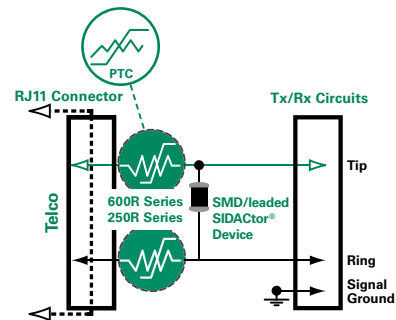

PTC Selection Worksheet

1. Define the circuit operating parameters.

- Normal operating current in amperes:
- Normal operating voltage in volts:
- Maximum interrupt current:
- Ambient temperature:
- Typical overload current:
- Required opening time at specified overload:
- Transient pulses expected:
- Agency approvals:
- Mounting type/form factor:
- Typical resistance (in circuit):

2. Select the proper circuit protection component.

(Refer to Table on Page 3 and specifications with Data Sheets)

3. Determine the opening time at fault.

Consult the Time-Current (T-C) Curve of each PTC series to determine if the selected part will operate within the constraints of your application.

If the device opens too soon, the application may experience nuisance operation. If the device does not open soon enough, the overcurrent may damage downstream components.

To determine the opening time for the chosen device, locate the overload current on the X-axis of the appropriate T-C Curve and follow its line up to its intersection with the curve. At this point read the time tested on the Y-axis. This is the average opening time for that device.

If your overload current falls to the right of the curve the device will open. If the overload current is to the left of the curve, the device will not operate.

4. Verify ambient operating parameters.

Ensure that the application voltage is less than or equal to the device's rated voltage and that the operating temperature limits are within those specified by the device.

5. Verify the device's dimensions.

Compare the maximum dimensions of the device to the space available in the application. The dimension of each product is included within each data sheets on the following pages.

6. Test the selected product in an actual application.

Legal Disclaimers

Liability

Littelfuse, Inc. its affiliates, agents, and employees, and all persons acting on its or their behalf (collectively, "Littelfuse"), disclaim any and all liability for any errors, inaccuracies or incompleteness contained here or in any other disclosure relating to any product. Littelfuse disclaims any and all liability arising out of the use or application of any product described herein or of any information provided herein to the maximum extent permitted by law. The product specifications do not expand or otherwise modify Littelfuse terms and conditions of purchase, including but not limited to the warranty expressed therein, which apply to these products.

Right to Make Changes

Littelfuse reserves the right to make any and all changes to the products described herein without notice.

Not Intended for Use in Life Support or Life Saving Applications

The products shown herein are not designed for use in life sustaining or life saving applications unless otherwise expressly indicated. Customers using or selling Littelfuse products not expressly indicated for use in such applications do so entirely at their own risk and agree to fully indemnify Littelfuse for any damages arising or resulting from such use or sale. Please contact authorized Littelfuse personnel to obtain terms and conditions regarding products designed for such applications.

Intellectual Property

No license, express or implied, by estoppel or otherwise, to any intellectual property rights is granted by this document or by any conduct of Littelfuse. Product names and markings noted herein may be registered trademarks of their respective owners. Littelfuse makes no representations or warranties of non-infringement or misappropriation of any third party intellectual property rights unless specifically provided for herein.



Disclaimer

Specifications, descriptions and data contained in this document are believed to be accurate. However, users should independently evaluate each product for the particular application. Littelfuse reserves the right to change any information contained herein without notice and may, at its sole discretion, change the design, manufacture or construction of any product. Visit www.littelfuse.com for the most up-to-date information. Littelfuse's only obligations for any of its products are specified in its Standard Terms and Conditions and Littelfuse shall not be liable for any indirect, consequential or incidental damages from any sale or use of any of its products.

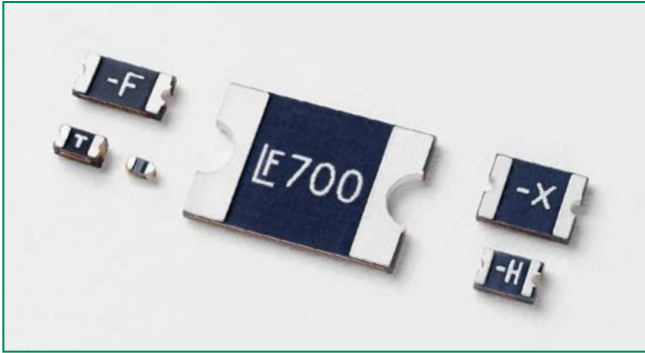
LoRho Surface Mount Series



Agency Approvals

AGENCY	AGENCY FILE NUMBER
	E183209
	R50119118

Applications

- USB peripherals including new USB 3.0 / 2.0 ports
- Li-ion / Li-Polymer battery packs
- Smart phones
- Tablet and Notebook PCs
- E-readers
- LCD / LED HDTV
- Computer peripherals
- Digital cameras and video cameras
- Hard disk drives
- Game consoles

Additional Information



Datasheet



Resources



Samples

Description

Littelfuse LoRho Surface Mount PPTC (Polymer Positive Temperature Coefficient) devices provide overcurrent protection for applications where ultra low internal resistance, ultra low voltage drop and automatic resettable protection are desired. This new series allows a higher hold current device in a smaller factor and lower profile as compared to a standard PPTC. It offers ultra low internal resistance while maintaining the high level electrical characteristics and performances of standard PPTC products. All devices are UL recognized and TUV approved and have maximum fault current of 50A. They are available in 0402 to 2920 sizes while the hold current ranges from 100mA to 7A.

Littelfuse 0402 size LoRho SMD PPTC is the smallest size surface mounted PPTC device available in the market.

Features

- Ultra low internal resistance
- Very thin profile
- Miniature size saves board space
- Allows a higher hold current device in a smaller factor and lower profile as compared to a standard PPTC
- Fast response to fault currents
- 0402 size available - the smallest PPTC in the market
- Compatible with high temperature solders
- Broadest range of Hold Current ratings (100mA to 7A)
- RoHS compliant, Lead Free and Halogen Free
- UL recognized and TUV approved
- 0603L150SL ideal for USB 3.0

WARNING

- Users shall independently assess the suitability of these devices for each of their applications
- Operation of these devices beyond the stated maximum ratings could result in damage to the devices and lead to electrical arcing and/or fire
- These devices are intended to protect against the effects of temporary over-current or over-temperature conditions and are not intended to perform as protective devices where such conditions are expected to be repetitive or prolonged in duration
- Exposure to silicon-based oils, solvents, electrolytes, acids, and similar materials can adversely affect the performance of these PPTC devices
- These devices undergo thermal expansion under fault conditions, and thus shall be provided with adequate space and be protected against mechanical stresses
- Circuits with inductance may generate a voltage ($L di/dt$) above the rated voltage of the PPTC device.

Electrical Characteristics

Part Number	Marking	I _{hold} (A)	I _{trip} (A)	V _{max} (Vdc)	I _{max} (A)	P _d typ. (W)	Maximum Time-To-Trip		Resistance		Agency Approvals	
							Current (A)	Time (Sec.)	R _{min} (Ω)	R _{1max} (Ω)	UL US	TÜV
0402L010SL		0.10	0.30	6	40	0.5	0.50	1.00	0.150	2.000	X	X
0402L020SL		0.20	0.50	6	40	0.5	1.00	1.00	0.100	1.250	X	X
0402L035SL		0.35	0.70	6	50	0.5	8.00	0.10	0.050	0.700	X	X
0402L050SL		0.50	1.00	6	50	0.5	8.00	0.10	0.040	0.400	X	X
0603L050SL	K	0.50	1.00	6	50	0.6	8.00	0.10	0.070	0.350	X	X
0603L075SL	N	0.75	1.50	6	50	0.6	8.00	0.20	0.020	0.165	X	X
0603L100SL	S	1.00	1.80	6	50	0.6	8.00	0.30	0.040	0.120	X	X
0603L150SL	T	1.50	3.00	6	50	0.6	8.00	0.50	0.007	0.080	X	X
0603L175SL	V	1.75	3.50	6	50	0.6	8.00	0.60	0.005	0.060	X	X
0805L075SL	-G	0.75	1.50	6	50	0.6	8.00	0.20	0.040	0.160	X	X
0805L110SL	-H	1.10	1.80	6	50	0.6	8.00	0.30	0.030	0.130	X	X
0805L150SL	-K	1.50	3.00	6	50	0.6	8.00	0.50	0.015	0.065	X	X
0805L175SL	-V	1.75	3.50	6	50	0.6	8.00	0.60	0.005	0.055	X	X
0805L200SLTH	-L	2.00	4.00	6	50	0.6	8.00	1.00	0.005	0.045	X	X
0805L260SLTH	-S	2.60	5.00	6	50	0.6	8.00	4.00	0.003	0.035	X	X
0805L300SL	-N	3.00	6.00	6	50	0.6	8.00	5.00	0.003	0.030	X	X
1206L075SL	-G	0.75	1.50	6	50	0.8	8.00	0.30	0.017	0.180	X	X
1206L110SL	-H	1.10	2.20	6	50	0.8	8.00	0.30	0.015	0.100	X	X
1206L150SL	-K	1.50	3.90	6	50	0.8	8.00	0.30	0.010	0.065	X	X
1206L110/12SL	-H1	1.10	2.20	12	50	0.8	8.00	0.30	0.015	0.130	X	X
1206L150/12SL	-K1	1.50	3.00	12	50	0.8	8.00	0.30	0.010	0.080	X	X
1206L175SL	-F	1.75	3.50	6	50	0.8	8.00	0.40	0.005	0.030	X	X
1206L200SL	-L	2.00	4.00	6	50	0.8	8.00	0.50	0.005	0.025	X	X
1206L260SLTH	-S	2.60	5.00	6	50	0.8	8.00	4.00	0.003	0.026	X	X
1206L300SLTH	-N	3.00	6.00	6	50	0.8	8.00	4.00	0.003	0.020	X	X
1206L350SLTH	-T	3.50	7.00	6	50	0.8	8.00	5.00	0.003	0.018	X	X
1206L380SLTH*	-V	2.82*	8.00	6	50	0.8	8.00	5.00	0.002	0.014	X	X
1206L400SL	-Y	4.00	8.00	6	50	0.8	20.00	2.00	0.001	0.014	X	X
1206L450SL	-Z	4.50	9.00	6	50	0.8	22.50	2.00	0.001	0.014	X	X
1210L175SL	-J	1.75	3.50	6	50	0.8	8.00	2.50	0.006	0.040	X	X
1210L200SL	-L	2.00	4.00	6	50	0.8	8.00	3.00	0.005	0.024	X	X
1210L260SL	-S	2.60	5.00	6	50	0.8	8.00	4.00	0.003	0.020	X	X
1210L300SL	-N	3.00	6.00	6	50	0.8	15.00	2.00	0.003	0.020	X	X
1210L350SL	-T	3.50	7.00	6	50	0.8	17.50	2.00	0.003	0.018	X	X
1210L380SL	-X	3.80	8.00	6	50	0.8	8.00	5.00	0.002	0.016	X	X
1210L400SL	-V	4.00	8.00	6	50	0.8	8.00	5.00	0.001	0.014	X	X
1210L450SL	-Y	4.50	9.00	6	50	1.0	22.50	2.00	0.001	0.014	X	X
1812L190SL	LF-19	1.90	4.90	6	50	1.0	9.50	4.50	0.003	0.025	X	X
1812L260SL	LF-26	2.60	6.00	6	50	1.0	13.00	2.00	0.003	0.024	X	X
1812L270SL	LF-27	2.70	6.20	6	50	1.0	13.50	2.00	0.003	0.022	X	X
1812L300SL	LF-30	3.00	7.00	6	50	1.0	8.00	5.00	0.003	0.021	X	X
1812L350SL**	LF-35	3.50	8.10	6	50	1.0	8.00	5.00	0.003	0.020**	X	X
1812L370SL	LF-37	3.70	9.10	6	50	1.0	18.50	2.00	0.003	0.018	X	X
2920L700SL***	LF700	7.00	14.00	6	50	2.2	35.00	0.20	0.001	0.007	X	X

Notes:

- 0805L150SL and 1206L150SL are ideal for overcurrent protection in VBUS of USB 3.0 / USB 2.0 ports.
- * 1206L380SLTH has I_{hold} 2.82A for at least 15min @ 55°C. It is ideal for overcurrent protection in Li-ion / Li-Polymer battery packs of smartphones.
- ** 1812L350SL Typical Time-To-Trip is 50A at 0.013-0.020 seconds. R_{1min}=0.015ohm (resistance range 0.015-0.025ohm).
- *** 2920L700SL is ideal for overcurrent protection in Li-ion / Li-Polymer battery packs of tablet PC.

I_{hold} = Hold current: maximum current device will pass without tripping in 20°C still air.
 I_{trip} = Trip current: minimum current at which the device will trip in 20°C still air.
 V_{max} = Maximum voltage device can withstand without damage at rated current (I_{max})
 I_{max} = Maximum fault current device can withstand without damage at rated voltage (V_{max})
 P_d = Power dissipated from device when in the tripped state at 20°C still air.

R_{min} = Minimum resistance of device in initial (un-soldered) state.
 R_{1max} = Maximum resistance of device at 20°C measured one hour after tripping or reflow soldering of 260°C for 20 sec.

Caution: Operation beyond the specified rating may result in damage and possible arcing and flame.

Temperature Rerating

Ambient Operation Temperature								
	-40°C	-20°C	0°C	20°C	40°C	60°C	70°C	85°C
Part Number	Hold Current (A)							
0402L010SL	0.15	0.13	0.12	0.10	0.09	0.07	0.06	0.05
0402L020SL	0.29	0.27	0.24	0.20	0.17	0.14	0.11	0.10
0402L035SL	0.51	0.47	0.41	0.35	0.30	0.25	0.20	0.18
0402L050SL	0.74	0.67	0.59	0.50	0.43	0.36	0.29	0.26
0603L050SL	0.82	0.73	0.63	0.50	0.41	0.39	0.24	0.14
0603L075SL	1.23	1.08	0.94	0.75	0.61	0.44	0.34	0.23
0603L100SL	1.55	1.37	1.19	1.00	0.83	0.62	0.50	0.31
0603L150SL	2.31	2.06	1.79	1.50	1.22	0.93	0.75	0.47
0603L175SL	2.57	2.33	2.07	1.75	1.49	1.24	1.00	0.91
0805L075SL	1.24	1.07	0.94	0.75	0.62	0.47	0.37	0.23
0805L110SL	1.93	1.65	1.38	1.10	0.83	0.55	0.41	0.21
0805L150SL	2.37	2.07	1.80	1.50	1.25	0.93	0.74	0.50
0805L175SL	2.57	2.33	2.07	1.75	1.49	1.24	1.00	0.91
0805L200SLTH	2.94	2.66	2.36	2.00	1.70	1.42	1.14	1.04
0805L260SLTH	3.82	3.46	3.07	2.60	2.21	1.85	1.48	1.35
0805L300SL	4.41	3.99	3.54	3.00	2.55	2.13	1.71	1.56
1206L075SL	1.10	1.00	0.89	0.75	0.64	0.53	0.43	0.39
1206L110SL	2.00	1.70	1.40	1.10	0.83	0.56	0.44	0.36
1206L150SL	2.67	2.32	1.95	1.50	1.15	0.78	0.64	0.52
1206L110/12SL	1.62	1.46	1.30	1.10	0.94	0.78	0.63	0.57
1206L150/12SL	2.21	2.00	1.77	1.50	1.28	1.07	0.86	0.78
1206L175SL	2.57	2.33	2.07	1.75	1.49	1.24	1.00	0.91
1206L200SL	3.30	2.90	2.50	2.00	1.62	1.16	0.90	0.52
1206L260SLTH	3.71	3.42	3.01	2.60	2.08	1.49	1.30	0.89
1206L300SLTH	4.41	3.99	3.54	3.00	2.55	2.13	1.71	1.56
1206L350SLTH	5.15	4.66	4.13	3.50	2.98	2.49	2.00	1.82
1206L380SLTH	5.59	5.05	4.48	3.80	3.23	2.70	2.17	1.98
1206L400SL	5.71	5.26	4.63	4.00	3.20	2.29	2.00	1.37
1206L450SL	6.62	5.99	5.31	4.50	3.83	3.20	2.57	2.34
1210L175SL	2.57	2.33	2.07	1.75	1.49	1.24	1.00	0.91
1210L200SL	3.26	2.87	2.50	2.00	1.70	1.29	1.09	0.78
1210L260SL	3.82	3.46	3.07	2.60	2.21	1.85	1.48	1.35
1210L300SL	4.41	3.99	3.54	3.00	2.55	2.13	1.71	1.56
1210L350SL	5.00	4.60	4.05	3.50	2.80	2.00	1.60	1.00
1210L380SL	6.00	5.28	4.52	3.80	3.15	2.39	2.09	1.60
1210L400SL	5.71	5.26	4.63	4.00	3.20	2.29	2.00	1.37
1210L450SL	6.62	5.99	5.31	4.50	3.83	3.20	2.57	2.34
1812L190SL	3.00	2.58	2.22	1.90	1.49	1.14	0.93	0.61
1812L260SL	3.82	3.46	3.07	2.60	2.21	1.85	1.48	1.35
1812L270SL	3.86	3.55	3.12	2.70	2.16	1.54	1.35	0.93
1812L300SL	4.41	3.99	3.54	3.00	2.55	2.13	1.71	1.56
1812L350SL	5.43	4.73	4.13	3.50	2.80	2.10	1.75	1.12
1812L370SL	5.44	4.92	4.37	3.70	3.15	2.63	2.11	1.92
2920L700SL	10.00	9.20	8.10	7.00	5.60	4.00	3.50	2.40

Notes: The temperature rerating data is for reference only. Please contact Littelfuse technical support for detail temperature rerating information.

Temperature Derating Curve

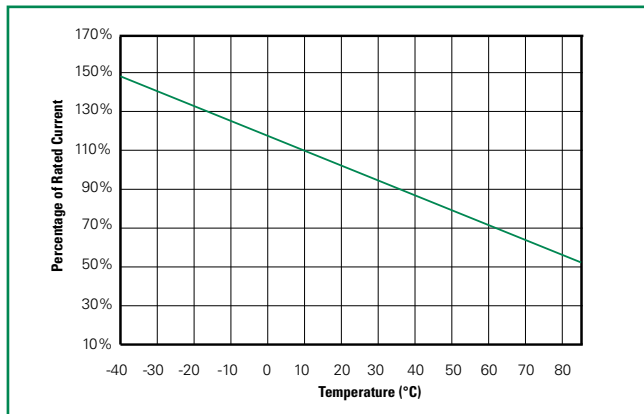

Physical Specifications

Terminal Material	Solder-Plated Copper (Solder Material: Matte Tin (Sn))
Lead Solderability	Meets EIA Specification RS186-9E, ANSI/J-STD-002, Category 3.

Environmental Specifications

Operating Temperature	-40°C to +85°C
Maximum Device Surface Temperature in Tripped State	125°C
Passive Aging	+85°C, 1000 hours -/+10% typical resistance change
Humidity Aging	+85°C, 85% R.H., 100 hours -/+15% typical resistance change
Thermal Shock	MIL-STD-202, Method 107 +85°C/-40°C 20 times -30% typical resistance change
Solvent Resistance	MIL-STD-202, Method 215 No change
Vibration	MIL-STD-883, Method 2007, Condition A No change
Moisture Sensitivity Level	Level 1, J-STD-020

Soldering Parameters

Profile Feature	Pb-Free Assembly	
Average Ramp-Up Rate ($T_{S(max)}$ to T_P)	3°C/second max	
Pre Heat:	Temperature Min ($T_{S(min)}$)	150°C
	Temperature Max ($T_{S(max)}$)	200°C
	Time (Min to Max) (t_s)	60 – 180 secs
Time Maintained Above:	Temperature (T_L)	217°C
	Temperature (t_L)	60 – 150 seconds
Peak / Classification Temperature (T_P)	260 ^{+0/-5} °C	
Time within 5°C of actual peak Temperature (t_p)	20 – 40 seconds	
Ramp-down Rate	6°C/second max	
Time 25°C to peak Temperature (T_P)	8 minutes Max.	

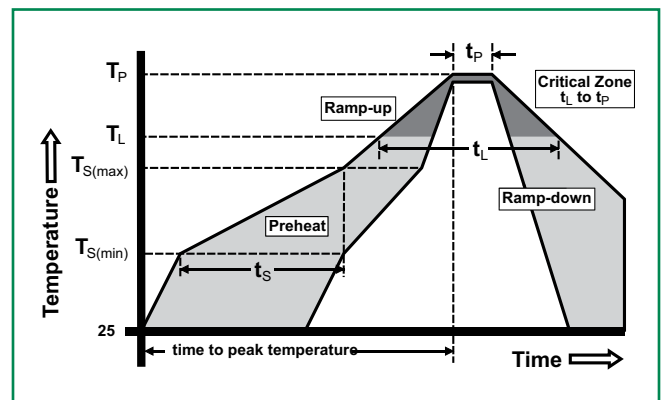

- All temperature refer to topside of the package, measured on the package body surface
- If reflow temperature exceeds the recommended profile, devices may not meet the performance requirements
- Recommended reflow methods: IR, vapor phase oven, hot air oven, N₂ environment for lead
- Recommended maximum paste thickness is 0.25mm (0.010 inch)
- Devices can be cleaned using standard industry methods and solvents
- Devices can be reworked using the standard industry practices

Disclaimer Notice - Information furnished is believed to be accurate and reliable. However, users should independently evaluate the suitability of and test each product selected for their own applications. Littelfuse products are not designed for, and may not be used in, all applications. Read complete Disclaimer Notice at www.littelfuse.com/disclaimer-electronics.

Dimensions

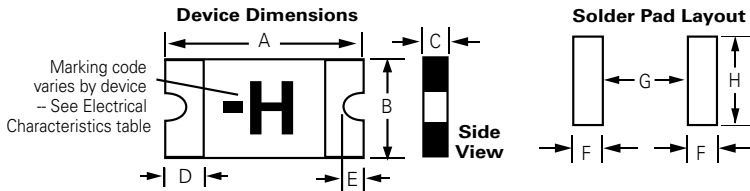

Part Number	Device Dimension																				Solder Pad					
	A				B				C				D				E				F		G		H	
	inch		mm		inch		mm		inch		mm		inch		mm		inch		mm		inch	mm	inch	mm	inch	mm
	Min	Max	Min	Max	Min	Max	Min	Max	Min	Max	Min	Max	Min	Max	Min	Max	Min	Max	Min	Max	Min	Max	Min	Max	Min	Max
0402L010SL	0.03	0.05	0.85	1.15	0.01	0.03	0.35	0.65	0.01	0.02	0.20	0.60	0.004	0.02	0.10	0.45	-	0.02	-	0.40	0.02	0.60	0.02	0.40	0.03	0.70
0402L020SL	0.03	0.05	0.85	1.15	0.01	0.03	0.35	0.65	0.01	0.02	0.20	0.60	0.004	0.02	0.10	0.45	-	0.02	-	0.40	0.02	0.60	0.02	0.40	0.03	0.70
0402L035SL	0.03	0.05	0.85	1.15	0.01	0.03	0.35	0.65	0.01	0.02	0.20	0.60	0.004	0.02	0.10	0.45	-	0.02	-	0.40	0.02	0.60	0.02	0.40	0.03	0.70
0402L050SL	0.03	0.05	0.85	1.15	0.01	0.03	0.35	0.65	0.01	0.02	0.20	0.60	0.004	0.02	0.10	0.45	-	0.02	-	0.40	0.02	0.60	0.02	0.40	0.03	0.70
0603L050SL	0.06	0.07	1.40	1.80	0.02	0.04	0.60	1.00	0.02	0.03	0.40	0.75	0.01	0.02	0.15	0.50	-	0.02	-	0.40	0.04	1.00	0.03	0.80	0.04	1.00
0603L075SL	0.06	0.07	1.40	1.80	0.02	0.04	0.60	1.00	0.02	0.03	0.40	0.75	0.01	0.02	0.15	0.50	-	0.02	-	0.40	0.04	1.00	0.03	0.80	0.04	1.00
0603L100SL	0.06	0.07	1.40	1.80	0.02	0.04	0.60	1.00	0.02	0.03	0.40	0.75	0.01	0.02	0.15	0.50	-	0.02	-	0.40	0.04	1.00	0.03	0.80	0.04	1.00
0603L150SL	0.06	0.07	1.40	1.80	0.02	0.04	0.60	1.00	0.02	0.04	0.40	1.00	0.01	0.02	0.15	0.50	-	0.02	-	0.40	0.04	1.00	0.03	0.80	0.04	1.00
0603L175SL	0.06	0.07	1.40	1.80	0.02	0.04	0.60	1.00	0.02	0.04	0.40	1.00	0.01	0.02	0.15	0.50	-	0.02	-	0.40	0.04	1.00	0.03	0.80	0.04	1.00
0805L075SL	0.08	0.09	2.00	2.20	0.05	0.06	1.20	1.50	0.02	0.03	0.40	0.75	0.01	0.02	0.20	0.55	0.002	0.02	0.05	0.45	0.04	1.00	0.05	1.20	0.06	1.50
0805L110SL	0.08	0.09	2.00	2.20	0.05	0.06	1.20	1.50	0.02	0.03	0.40	0.75	0.01	0.02	0.20	0.55	0.002	0.02	0.05	0.45	0.04	1.00	0.05	1.20	0.06	1.50
0805L150SL	0.08	0.09	2.00	2.20	0.05	0.06	1.20	1.50	0.02	0.03	0.40	0.75	0.01	0.02	0.20	0.55	0.002	0.02	0.05	0.45	0.04	1.00	0.05	1.20	0.06	1.50
0805L175SL	0.08	0.09	2.00	2.20	0.05	0.06	1.20	1.50	0.02	0.02	0.40	0.60	0.01	0.02	0.20	0.55	0.002	0.02	0.05	0.45	0.04	1.00	0.05	1.20	0.06	1.50
0805L200SLTH	0.08	0.09	2.00	2.20	0.05	0.06	1.20	1.50	0.02	0.03	0.40	0.75	0.01	0.02	0.20	0.55	0.002	0.02	0.05	0.45	0.04	1.00	0.05	1.20	0.06	1.50
0805L260SLTH	0.08	0.09	2.00	2.20	0.05	0.06	1.20	1.50	0.02	0.03	0.40	0.75	0.01	0.02	0.20	0.55	0.002	0.02	0.05	0.45	0.04	1.00	0.05	1.20	0.06	1.50
0805L300SL	0.08	0.09	2.00	2.20	0.05	0.06	1.20	1.50	0.02	0.06	0.60	1.40	0.01	0.02	0.20	0.55	0.002	0.02	0.05	0.45	0.04	1.00	0.05	1.20	0.06	1.50
1206L075SL	0.12	0.13	3.00	3.40	0.06	0.07	1.50	1.80	0.02	0.03	0.40	0.70	0.01	0.03	0.25	0.75	0.002	0.02	0.05	0.45	0.04	1.00	0.07	1.80	0.07	1.80
1206L110SL	0.12	0.13	3.00	3.40	0.06	0.07	1.50	1.80	0.02	0.03	0.40	0.75	0.01	0.03	0.25	0.75	0.002	0.02	0.05	0.45	0.04	1.00	0.07	1.80	0.07	1.80
1206L150SL	0.12	0.13	3.00	3.40	0.06	0.07	1.50	1.80	0.02	0.03	0.40	0.70	0.01	0.03	0.25	0.75	0.002	0.02	0.05	0.45	0.04	1.00	0.07	1.80	0.07	1.80
1206L110/12SL	0.12	0.13	3.00	3.40	0.06	0.07	1.50	1.80	0.02	0.03	0.50	0.85	0.01	0.03	0.25	0.75	0.002	0.02	0.05	0.45	0.04	1.00	0.07	1.80	0.07	1.80
1206L150/12SL	0.12	0.13	3.00	3.40	0.06	0.07	1.50	1.80	0.02	0.03	0.50	0.85	0.01	0.03	0.25	0.75	0.002	0.02	0.05	0.45	0.04	1.00	0.07	1.80	0.07	1.80
1206L175SL	0.12	0.13	3.00	3.40	0.06	0.07	1.50	1.80	0.02	0.02	0.40	0.60	0.01	0.03	0.25	0.75	0.002	0.02	0.05	0.45	0.04	1.00	0.07	1.80	0.07	1.80
1206L200SL	0.12	0.13	3.00	3.40	0.06	0.07	1.50	1.80	0.02	0.02	0.40	0.60	0.01	0.03	0.25	0.75	0.002	0.02	0.05	0.45	0.04	1.00	0.07	1.80	0.07	1.80
1206L260SLTH	0.12	0.13	3.00	3.40	0.06	0.07	1.50	1.80	0.02	0.03	0.40	0.70	0.01	0.03	0.25	0.75	0.002	0.02	0.05	0.45	0.04	1.00	0.07	1.80	0.07	1.80
1206L300SLTH	0.12	0.13	3.00	3.40	0.06	0.07	1.50	1.80	0.02	0.03	0.40	0.80	0.01	0.03	0.25	0.75	0.002	0.02	0.05	0.45	0.04	1.00	0.07	1.80	0.07	1.80
1206L350SLTH	0.12	0.13	3.00	3.40	0.06	0.07	1.50	1.80	0.02	0.03	0.40	0.75	0.01	0.03	0.25	0.75	0.002	0.02	0.05	0.45	0.04	1.00	0.07	1.80	0.07	1.80
1206L380SLTH	0.12	0.13	3.00	3.40	0.06	0.07	1.50	1.80	0.02	0.03	0.40	0.70	0.01	0.03	0.25	0.75	0.002	0.02	0.05	0.45	0.04	1.00	0.07	1.80	0.07	1.80
1206L400SL	0.12	0.13	3.00	3.40	0.06	0.07	1.50	1.80	0.02	0.06	0.60	1.40	0.01	0.03	0.25	0.75	0.002	0.02	0.05	0.45	0.04	1.00	0.07	1.80	0.07	1.80
1206L450SL	0.12	0.13	3.00	3.40	0.06	0.07	1.50	1.80	0.02	0.06	0.60	1.40	0.01	0.03	0.25	0.75	0.002	0.02	0.05	0.45	0.04	1.00	0.07	1.80	0.07	1.80
1210L175SL	0.12	0.14	3.00	3.43	0.09	0.11	2.35	2.80	0.02	0.03	0.40	0.70	0.01	0.03	0.25	0.75	0.004	0.02	0.10	0.50	0.04	1.00	0.08	2.00	0.10	2.50
1210L200SL	0.12	0.14	3.00	3.43	0.09	0.11	2.35	2.80	0.02	0.03	0.40	0.70	0.01	0.03	0.25	0.75	0.004	0.02	0.10	0.50	0.04	1.00	0.08	2.00	0.10	2.50
1210L260SL	0.12	0.14	3.00	3.43	0.09	0.11	2.35	2.80	0.02	0.03	0.40	0.70	0.01	0.03	0.25	0.75	0.004	0.02	0.10	0.50	0.04	1.00	0.08	2.00	0.10	2.50
1210L300SL	0.12	0.14	3.00	3.43	0.09	0.11	2.35	2.80	0.02	0.05	0.60	1.20	0.01	0.03	0.25	0.75	0.004	0.02	0.10	0.50	0.04	1.00	0.08	2.00	0.10	2.50
1210L350SL	0.12	0.14	3.00	3.43	0.09	0.11	2.35	2.80	0.02	0.04	0.60	1.00	0.01	0.03	0.25	0.75	0.00	0.02	0.10	0.50	0.04	1.00	0.08	2.00	0.10	2.50
1210L380SL	0.12	0.14	3.00	3.43	0.09	0.11	2.35	2.80	0.02	0.03	0.40	0.65	0.01	0.03	0.25	0.75	0.00	0.02	0.10	0.50	0.04	1.00	0.08	2.00	0.10	2.50
1210L400SL	0.12	0.14	3.00	3.43	0.09	0.11	2.35	2.80	0.02	0.04	0.60	1.00	0.01	0.03	0.25	0.75	0.00	0.02	0.10	0.50	0.04	1.00	0.08	2.00	0.10	2.50
1210L450SL	0.12	0.14	3.00	3.43	0.09	0.11	2.35	2.80	0.02	0.05	0.60	1.20	0.01	0.03	0.25	0.75	0.00	0.02	0.10	0.50	0.04	1.00	0.08	2.00	0.10	2.50
1812L190SL	0.17	0.19	4.37	4.73	0.12	0.13	3.07	3.41	0.02	0.03	0.40	0.70	0.01	0.05	0.30	1.20	0.01	0.03	0.15	0.65	0.07	1.78	0.14	3.45	0.12	3.15
1812L260SL	0.17	0.19	4.37	4.73	0.12	0.13	3.07	3.41	0.02	0.03	0.40	0.70	0.01	0.05	0.30	1.20	0.01	0.03	0.15	0.65	0.07	1.78	0.14	3.45	0.12	3.15
1812L270SL	0.17	0.19	4.37	4.73	0.12	0.13	3.07	3.41	0.02	0.03	0.40	0.70	0.01	0.05	0.30	1.20	0.01	0.03	0.15	0.65	0.07	1.78	0.14	3.45	0.12	3.15
1812L300SL	0.17	0.19	4.37	4.73	0.12	0.13	3.07	3.41	0.02	0.03	0.40	0.75	0.01	0.05	0.30	1.20	0.01	0.03	0.15	0.65	0.07	1.78	0.14	3.45	0.12	3.15
1812L350SL	0.17	0.19	4.37	4.73	0.12	0.13	3.07	3.41	0.02	0.03	0.40	0.70	0.01	0.05	0.30	1.20	0.01	0.03	0.15	0.65	0.07	1.78	0.14	3.45	0.12	3.15
1812L370SL	0.17	0.19	4.37	4.73	0.12	0.13	3.07	3.41	0.02	0.03	0.40	0.70	0.01	0.05	0.30	1.20	0.01	0.03	0.15	0.65	0.07	1.78	0.14	3.45	0.12	3.15
2920L700SL	0.26	0.31	6.73	7.98	0.19	0.21	4.80	5.44	0.02	0.03	0.40	0.65	0.01	0.10	0.30	2.50	0.01	0.08	0.25	2.00	0.08	2.00	0.18	4.60	0.21	5.30

Packaging

Part Number	Ordering Number	I _{hold} (A)	I _{hold} Code	Packaging Option	Quantity	Quantity & Packaging Codes
0402L010SL	0402L010SLKLR	0.10	010	Tape & Reel	10,000	KR
0402L020SL	0402L020SLKLR	0.20	020		10,000	KR
0402L035SL	0402L035SLKLR	0.35	035		10,000	KR
0402L050SL	0402L050SLKLR	0.50	050		10,000	KR
0603L050SL	0603L050SLYLR	0.50	050		4,000	YR
0603L075SL	0603L075SLYLR	0.75	075		4,000	YR
0603L100SL	0603L100SLYLR	1.00	100		4,000	YR
0603L150SL	0603L150SLYLR	1.50	150		4,000	YR
0603L175SL	0603L175SLYLR	1.75	175		4,000	YR
0805L075SL	0805L075SLYLR	0.75	075		4,000	YR
0805L110SL	0805L110SLYLR	1.10	110		4,000	YR
0805L150SL	0805L150SLYLR	1.50	150		4,000	YR
0805L175SL	0805L175SLYLR	1.75	175		4,000	YR
0805L200SLTH	0805L200SLTHYR	2.00	200		4,000	YR
0805L260SLTH	0805L260SLTHYR	2.60	260		4,000	YR
0805L300SL	0805L300SLWR	3.00	300		3,000	WR
1206L075SL	1206L075SLYLR	0.75	075		4,000	YR
1206L110SL	1206L110SLYLR	1.10	110		4,000	YR
1206L150SL	1206L150SLYLR	1.50	150		4,000	YR
1206L110/12SL	1206L110/12SLYLR	1.10	110		4,000	YR
1206L150/12SL	1206L150/12SLYLR	1.50	150		4,000	YR
1206L175SL	1206L175SLYLR	1.75	175		4,000	YR
1206L200SL	1206L200SLYLR	2.00	200		4,000	YR
1206L260SLTH	1206L260SLTHYR	2.60	260		4,000	YR
1206L300SLTH	1206L300SLTHYR	3.00	300		4,000	YR
1206L350SLTH	1206L350SLTHYR	3.50	350		4,000	YR
1206L380SLTH*	1206L380SLTHYR	2.82*	380		4,000	YR
1206L400SL	1206L400SLWR	4.00	400		3,000	WR
1206L450SL	1206L450SLWR	4.50	450		3,000	WR
1210L175SL	1210L175SLYLR	1.75	175		4,000	YR
1210L200SL	1210L200SLYLR	2.00	200		4,000	YR
1210L260SL	1210L260SLYLR	2.60	260		4,000	YR
1210L300SL	1210L300SLYLR	3.00	300		4,000	YR
1210L350SL	1210L350SLWR	3.50	350		3,000	WR
1210L380SL	1210L380SLYLR	3.80	380		4,000	YR
1210L400SL	1210L400SLWR	4.00	400		3,000	WR
1210L450SL	1210L450SLWR	4.50	450		3,000	WR
1812L190SL	1812L190SLPR	1.90	190		2,000	PR
1812L260SL	1812L260SLPR	2.60	260		2,000	PR
1812L270SL	1812L270SLPR	2.70	270		2,000	PR
1812L300SL	1812L300SLPR	3.00	300	2,000	PR	
1812L350SL	1812L350SLPR	3.50	350	2,000	PR	
1812L370SL	1812L370SLPR	3.70	370	2,000	PR	
2920L700SL	2920L700SLPR	7.00	700	2,000	PR	

Notes: *1206L380SLTH has I_{hold} 2.82A for at least 15min @ 55°C.

Part Ordering Number System

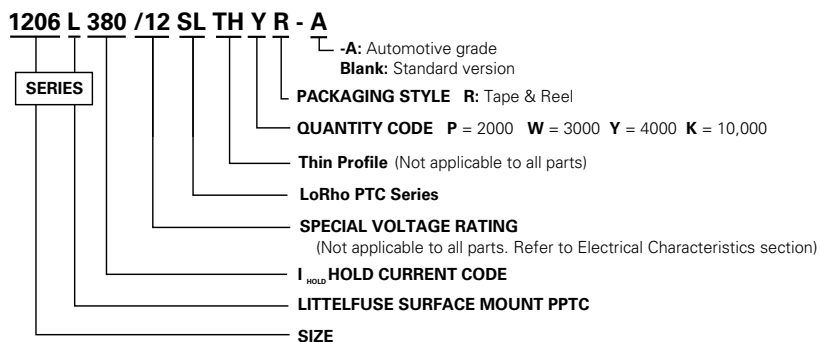

Tape and Reel Specifications

	0402L010SL 0402L020SL 0402L035SL 0402L050SL
--	--

TAPE DIMENSIONS: EIA-481-1 (mm)	
C_t	0.05 ± 0.01
D_d	1.5 ± 0.1
D_s	4.0 ± 0.1
P_d	0.41 ± 0.1
P_h	1.12 ± 0.1
P_s	2.0 ± 0.1
P_w	0.65 ± 0.03
T_t	0.61 ± 0.1
T_w	8.0 ± 0.1
Leader min.	390
Trailer min.	160

REEL DIMENSIONS: EIA-481-1 (mm)	
H	12.0 ± 0.5
W	9.0 ± 0.5
D	Ø60 ± 0.5
F	Ø13.0 ± 0.2
C	Ø178 ± 1
W₁	2.2 ± 0.5
W₂	3.0 ± 0.5
W₃	4.0 ± 0.5
W₄	5.5 ± 0.5

Dimensions for 0402 size product (see table at left)

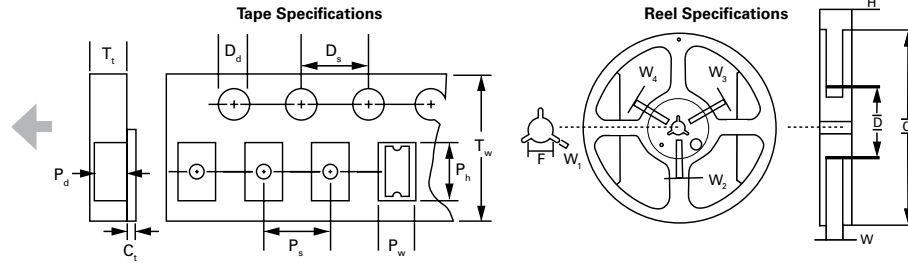

Dimensions for 0603, 0805, 1206, 1210, 1812 and 2920 size product (see table below)

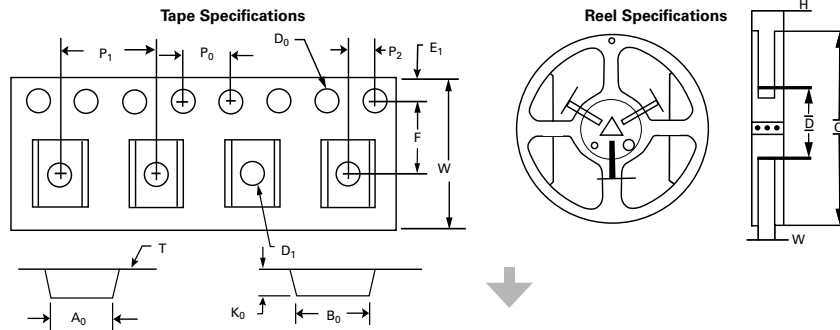

	0603L050SL 0603L075SL 0603L100SL	0603L150SL 0603L175SL	0805L075SL 0805L110SL 0805L150SL 0805L175SL 0805L200SLTH 0805L260SLTH	0805L300SL	1206L075SL 1206L110SL 1206L150SL 1206L110/12SL 1206L150/12SL 1206L175SL 1206L200SL 1206L260SLTH 1206L300SLTH 1206L350SLTH 1206L380SLTH	1206L400SL 1206L450SL	1210L175SL 1210L200SL 1210L260SL 1210L300SL 1210L380SL	1210L350SL 1210L400SL 1210L450SL	1812L190SL 1812L260SL 1812L270SL 1812L300SL 1812L350SL 1812L370SL	2920L700SL
--	--	--------------------------	--	------------	--	--------------------------	--	--	--	------------

TAPE DIMENSIONS: EIA-481-1 (mm)										
W	8.00 ± 0.30	8.00 ± 0.30	8.00 ± 0.10	8.00 ± 0.30	8.20 +0.10/-0.30	8.15 +0.15/-0.30	8.00 ± 0.30	8.00 ± 0.30	12.00 ± 0.30	16.00 ± 0.30
F	3.50 ± 0.05	3.50 ± 0.05	3.50 ± 0.05	3.50 ± 0.05	3.50 ± 0.05	3.50 ± 0.05	3.50 ± 0.05	3.50 ± 0.05	5.50 ± 0.05	7.50 ± 0.10
E₁	1.75 ± 0.10	1.75 ± 0.10	1.75 ± 0.10	1.75 ± 0.10	1.75 ± 0.10	1.75 ± 0.10	1.75 ± 0.10	1.75 ± 0.10	1.75 ± 0.10	1.75 ± 0.10
D₀	1.55 ± 0.05	1.55 ± 0.05	1.55 ± 0.05	1.55 ± 0.05	1.55 ± 0.05	1.55 ± 0.05	1.55 ± 0.05	1.55 ± 0.05	1.55 ± 0.05	1.55 ± 0.05
D₁	0.50 ± 0.10	0.50 ± 0.10	1.00 (Min.)	1.00 ± 0.10	1.00 ± 0.10	1.00 ± 0.10	1.00 (Min.)	1.00 (Min.)	1.55 (Min.)	1.50 ± 0.10
P₀	4.00 ± 0.10	4.00 ± 0.10	4.00 ± 0.08	4.00 ± 0.10	4.00 ± 0.10	4.00 ± 0.10	4.00 ± 0.10	4.00 ± 0.10	4.00 ± 0.10	4.00 ± 0.10
P₁	4.00 ± 0.10	4.00 ± 0.10	4.00 ± 0.10	4.00 ± 0.10	4.00 ± 0.10	4.00 ± 0.10	4.00 ± 0.10	4.00 ± 0.10	8.00 ± 0.10	8.00 ± 0.10
P₂	2.00 ± 0.05	2.00 ± 0.05	2.00 ± 0.05	2.00 ± 0.05	2.00 ± 0.05	2.00 ± 0.05	2.00 ± 0.05	2.00 ± 0.05	2.00 ± 0.05	2.00 ± 0.10
A₀	1.10 ± 0.10	1.10 ± 0.10	1.60 ± 0.10	1.65 ± 0.10	1.95 ± 0.10	1.92 ± 0.10	2.82 ± 0.10	2.82 ± 0.10	3.58 ± 0.10	5.74 ± 0.10
B₀	1.92 ± 0.10	1.92 ± 0.10	2.30 ± 0.10	2.35 ± 0.10	3.65 ± 0.10	3.65 ± 0.10	3.46 ± 0.10	3.50 ± 0.10	4.93 ± 0.10	8.02 ± 0.10
T	0.20 ± 0.10	0.20 ± 0.10	0.25 ± 0.10	0.25 ± 0.10	0.20 ± 0.10	0.25 ± 0.10	0.25 ± 0.10	0.20 ± 0.10	0.25 ± 0.10	0.30 ± 0.10
K₀	0.72 ± 0.10	0.96 ± 0.10	0.90 ± 0.10	1.50 ± 0.10	0.87 ± 0.10	1.30 ± 0.10	1.00 ± 0.10	1.30 ± 0.10	0.87 ± 0.06	0.91 ± 0.10
Leader min.	390									
Trailer min.	160									
REEL DIMENSIONS: EIA-481-1 (mm)										
H	11.0 ± 0.5								16.0 ± 0.5	19.5 ± 1.0
W	9.0 ± 1.5								13.2 ± 1.5	17 ± 0.2
C	Ø178 ± 1.0								Ø178 ± 1.0	Ø180 ± 3.0
D	Ø60.2 ± 0.5								Ø60.2 ± 0.5	Ø60 ± 0.5

0402L Series



Description

The 0402L Series PTC provides surface mount overcurrent protection for applications where space is at a premium and resettable protection is desired.



Features

- RoHS compliant, lead-free and halogen free
- Fast response to fault currents
- Compact design saves board space
- Low resistance
- Low-profile
- Compatible with high temperature solders
- 0402 size- the smallest PPTC in the market compatible with high temperature solders

Applications

- USB peripherals
- Disk drives
- CD-ROMs
- Plug and play protection for motherboards and peripherals
- PDAs / digital cameras
- Game console port protection
- Tablet and Notebook PCs
- E-readers

Agency Approvals

AGENCY	AGENCY FILE NUMBER
	E183209
	R50119118

Additional Information



Datasheet





Resources



Samples

Electrical Characteristics

Part Number	I_{hold} (A)	I_{trip} (A)	V_{max} (Vdc)	I_{max} (A)	P_d typ. (W)	Maximum Time To Trip		Resistance		Agency Approvals	
						Current (A)	Time (Sec.)	R_{min} (Ω)	R_{1max} (Ω)		
0402L010SL	0.10	0.30	6	40	0.5	0.50	1.00	0.150	2.000	X	X
0402L020SL	0.20	0.50	6	40	0.5	1.00	1.00	0.100	1.250	X	X
0402L035SL	0.35	0.70	6	50	0.5	8.00	0.10	0.050	0.700	X	X
0402L050SL	0.50	1.00	6	50	0.5	8.00	0.10	0.040	0.400	X	X

I_{hold} = Hold current: maximum current device will pass without tripping in 20°C still air.

I_{trip} = Trip current: minimum current at which the device will trip in 20°C still air.

V_{max} = Maximum voltage device can withstand without damage at rated current (I_{max})

I_{max} = Maximum fault current device can withstand without damage at rated voltage (V_{max})

P_d = Power dissipated from device when in the tripped state at 20°C still air.

R_{min} = Minimum resistance of device in initial (un-soldered) state.

R_{1max} = Maximum resistance of device at 20°C measured one hour after tripping or reflow soldering of 260°C for 20 sec.

Caution: Operation beyond the specified rating may result in damage and possible arcing and flame.

WARNING

- Users shall independently assess the suitability of these devices for each of their applications
- Operation of these devices beyond the stated maximum ratings could result in damage to the devices and lead to electrical arcing and/or fire
- These devices are intended to protect against the effects of temporary over-current or over-temperature conditions and are not intended to perform as protective devices where such conditions are expected to be repetitive or prolonged in duration
- Exposure to silicon-based oils, solvents, electrolytes, acids, and similar materials can adversely affect the performance of these PPTC devices
- These devices undergo thermal expansion under fault conditions, and thus shall be provided with adequate space and be protected against mechanical stresses
- Circuits with inductance may generate a voltage ($L di/dt$) above the rated voltage of the PPTC device.

Temperature Derating

Part Number	Ambient Operation Temperature								
	-40°C	-20°C	0°C	20°C	40°C	50°C	60°C	70°C	85°C
	Hold Current (A)								
0402L010SL	0.15	0.13	0.12	0.10	0.09	0.07	0.06	0.05	0.01
0402L020SL	0.29	0.27	0.24	0.20	0.17	0.14	0.11	0.10	0.03
0402L035SL	0.51	0.47	0.41	0.35	0.30	0.25	0.20	0.18	0.07
0402L050SL	0.74	0.67	0.59	0.50	0.43	0.36	0.29	0.26	0.10

Temperature Derating Curve

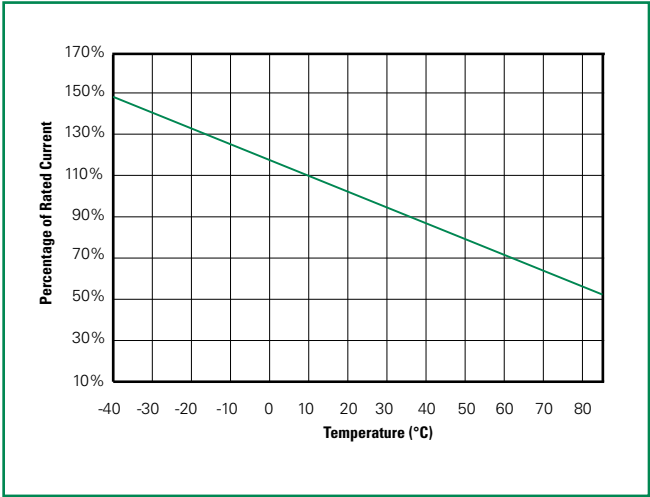

Note:
 Typical Temperature derating curve, refer to table for derating data

Average Time Current Curves

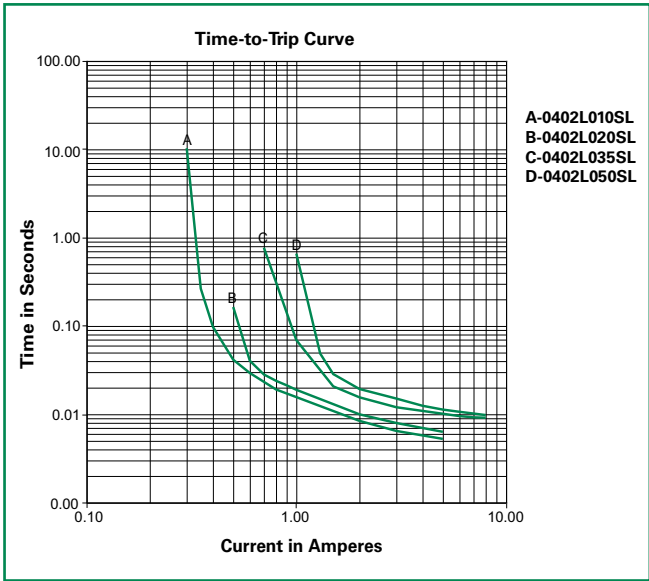

The average time current curves and Temperature Derating curve performance is affected by a number of variables, and these curves provided as guidance only. Customer must verify the performance in their application.

Soldering Parameters

Profile Feature		Pb-Free Assembly
Average Ramp-Up Rate ($T_{S(max)}$ to T_P)		3°C/second max
Pre Heat:	Temperature Min ($T_{S(min)}$)	150°C
	Temperature Max ($T_{S(max)}$)	200°C
	Time (Min to Max) (t_s)	60 – 180 secs
Time Maintained Above:	Temperature (T_L)	217°C
	Temperature (t_L)	60 – 150 seconds
Peak / Classification Temperature (T_P)		260 ^{+0/-5} °C
Time within 5°C of actual peak Temperature (t_p)		20 – 40 seconds
Ramp-down Rate		6°C/second max
Time 25°C to peak Temperature (T_P)		8 minutes Max.

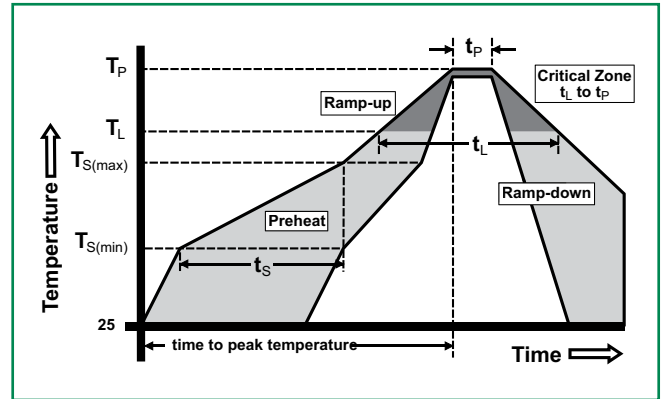

- All temperature refer to topside of the package, measured on the package body surface
- If reflow temperature exceeds the recommended profile, devices may not meet the performance requirements
- Recommended reflow methods: IR, vapor phase oven, hot air oven, N₂ environment for lead
- Recommended maximum paste thickness is 0.25mm (0.010inch)
- Devices can be cleaned using standard industry methods and solvents
- Devices can be reworked using the standard industry practices

Physical Specifications

Terminal Material	Solder-Plated Copper (Solder Material: Matte Tin (Sn))
Lead Solderability	Meets ANSI/J-STD-002, Category C.

Environmental Specifications

Operating/Storage Temperature	-40°C to +85°C
Maximum Device Surface Temperature in Tripped State	125°C
Solvent Resistance	MIL-STD-202, Method 215 No change
Vibration	MIL-STD-883, Method 2007, Condition A No change
Moisture Sensitivity Level	Level 1, J-STD-020

Dimensions

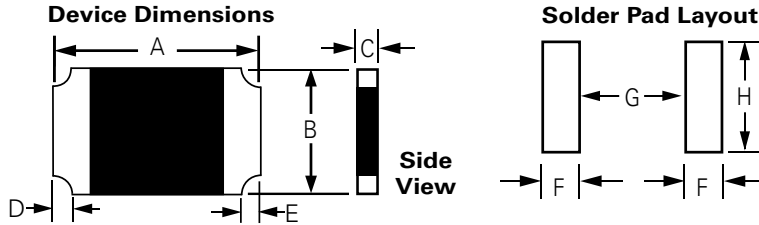

Device Top and Bottom Marking and Dimensions are Similar

Part Number	Device Dimension																				Solder Pad					
	A				B				C				D				E				F		G		H	
	inch		mm		inch		mm		inch		mm		inch		mm		inch		mm		inch	mm	inch	mm	inch	mm
	Min	Max	Min	Max	Min	Max	Min	Max	Min	Max	Min	Max	Min	Max	Min	Max	Min	Max	Min	Max	Min	Max	Min	Max	Min	Max
0402L010SL	0.03	0.05	0.85	1.15	0.01	0.03	0.35	0.65	0.01	0.02	0.20	0.60	0.004	0.02	0.10	0.45	-	0.02	-	0.40	0.02	0.60	0.02	0.40	0.03	0.70
0402L020SL	0.03	0.05	0.85	1.15	0.01	0.03	0.35	0.65	0.01	0.02	0.20	0.60	0.004	0.02	0.10	0.45	-	0.02	-	0.40	0.02	0.60	0.02	0.40	0.03	0.70
0402L035SL	0.03	0.05	0.85	1.15	0.01	0.03	0.35	0.65	0.01	0.02	0.20	0.60	0.004	0.02	0.10	0.45	-	0.02	-	0.40	0.02	0.60	0.02	0.40	0.03	0.70
0402L050SL	0.03	0.05	0.85	1.15	0.01	0.03	0.35	0.65	0.01	0.02	0.20	0.60	0.004	0.02	0.10	0.45	-	0.02	-	0.40	0.02	0.60	0.02	0.40	0.03	0.70

Part Ordering Number System

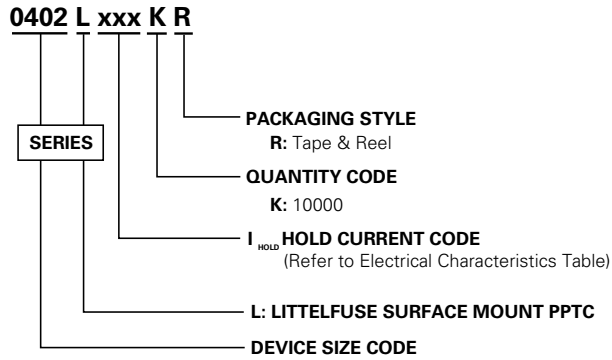

Packaging

Part Number	Ordering Number	I_{hold} (A)	I_{hold} Code	Packaging Option	Quantity	Quantity & Packaging Codes
0402L010SL	0402L010SLKR	0.10	010	Tape & Reel	10,000	KR
0402L020SL	0402L020SLKR	0.20	020		10,000	KR
0402L035SL	0402L035SLKR	0.35	035		10,000	KR
0402L050SL	0402L050SLKR	0.50	050		10,000	KR

Tape and Reel Specifications

TAPE SPECIFICATIONS: EIA-481-1 (mm)		REEL DIMENSIONS: EIA-481-1 (mm)	
	0402L010SL 0402L020SL 0402L035SL 0402L050SL		
C_t	0.05 ± 0.01	H	12.0 ± 0.5
D_d	1.5 ± 0.1	W	9.0 ± 0.5
D_s	4.0 ± 0.1	D	Ø60 ± 0.5
P_d	0.41 ± 0.1	F	Ø13.0 ± 0.2
P_h	1.12 ± 0.1	C	Ø178 ± 1
P_s	2.0 ± 0.1	W₁	2.2 ± 0.5
P_w	0.65 ± 0.03	W₂	3.0 ± 0.5
T_t	0.61 ± 0.1	W₃	4.0 ± 0.5
T_w	8.0 ± 0.1	W₄	5.5 ± 0.5
<i>Leader min.</i>	390	W₄	5.5+0.5
<i>Trailer min.</i>	160		

Tape and Reel Diagram

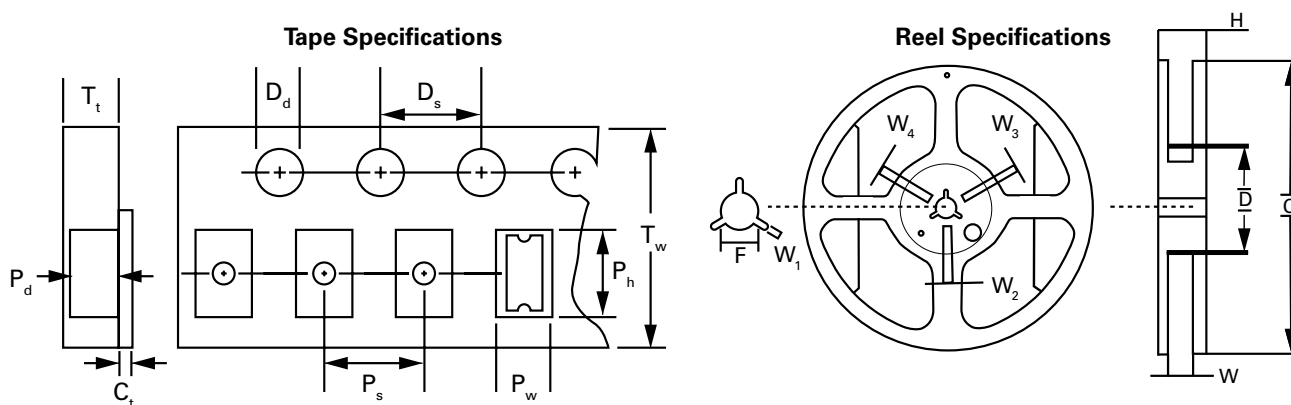

Disclaimer Notice - Information furnished is believed to be accurate and reliable. However, users should independently evaluate the suitability of and test each product selected for their own applications. Littelfuse products are not designed for, and may not be used in, all applications. Read complete Disclaimer Notice at www.littelfuse.com/disclaimer-electronics.

0603L Series



Description

The 0603L Series PTC provides surface mount overcurrent protection for applications where space is at a premium and resettable protection is desired.



Features

- RoHS compliant, lead-free and halogen free
- Fast response to fault currents
- Compact design saves board space
- Low resistance
- Low-profile
- Compatible with high temperature solders

Applications

- USB peripherals
- Disk drives
- CD-ROMs
- Plug and play protection for motherboards and peripherals
- PDAs / digital cameras
- Game console port protection

Agency Approvals

AGENCY	AGENCY FILE NUMBER
	E183209
	R50119118

Additional Information



Datashheet





Resources



Samples

Electrical Characteristics

Part Number	Marking	I_{hold} (A)	I_{trip} (A)	V_{max} (Vdc)	I_{max} (A)	P_d typ. (W)	Maximum Time To Trip		Resistance		Agency Approvals	
							Current (A)	Time (Sec.)	R_{min} (Ω)	R_{1max} (Ω)		
0603L004	-	0.04	0.12	24	20	0.5	0.20	1.00	4.00	40.00	X	X
0603L010	C	0.10	0.30	15	40	0.5	0.50	1.00	0.900	6.000	X	X
0603L020	H	0.20	0.50	9	40	0.5	1.00	0.60	0.550	3.500	X	X
0603L025	I	0.25	0.55	9	40	0.5	8.00	0.08	0.500	3.000	X	X
0603L035	F	0.35	0.75	6	40	0.5	8.00	0.10	0.200	1.000	X	X
0603L050	J	0.50	1.00	6	40	0.5	8.00	0.10	0.100	0.680	X	X

I_{hold} = Hold current: maximum current device will pass without tripping in 20°C still air.

I_{trip} = Trip current: minimum current at which the device will trip in 20°C still air.

V_{max} = Maximum voltage device can withstand without damage at rated current (I_{max})

I_{max} = Maximum fault current device can withstand without damage at rated voltage (V_{max})

P_d = Power dissipated from device when in the tripped state at 20°C still air.

R_{min} = Minimum resistance of device in initial (un-soldered) state.

R_{1max} = Maximum resistance of device at 20°C measured one hour after tripping or reflow soldering of 260°C for 20 sec.

Caution: Operation beyond the specified rating may result in damage and possible arcing and flame.

WARNING

- Users shall independently assess the suitability of these devices for each of their applications
- Operation of these devices beyond the stated maximum ratings could result in damage to the devices and lead to electrical arcing and/or fire
- These devices are intended to protect against the effects of temporary over-current or over-temperature conditions and are not intended to perform as protective devices where such conditions are expected to be repetitive or prolonged in duration
- Exposure to silicon-based oils, solvents, electrolytes, acids, and similar materials can adversely affect the performance of these PPTC devices
- These devices undergo thermal expansion under fault conditions, and thus shall be provided with adequate space and be protected against mechanical stresses
- Circuits with inductance may generate a voltage ($L di/dt$) above the rated voltage of the PPTC device.

Temperature Rerating

Part Number	Ambient Operation Temperature								
	-40°C	-20°C	0°C	20°C	40°C	50°C	60°C	70°C	85°C
	Hold Current (A)								
0603L004	0.052	0.048	0.044	0.040	0.032	0.028	0.024	0.020	0.012
0603L010	0.13	0.12	0.11	0.10	0.08	0.07	0.06	0.05	0.03
0603L020	0.27	0.25	0.23	0.20	0.17	0.14	0.12	0.10	0.07
0603L025	0.32	0.29	0.27	0.25	0.21	0.18	0.16	0.14	0.10
0603L035	0.47	0.41	0.38	0.35	0.29	0.26	0.24	0.20	0.14
0603L050	0.67	0.59	0.54	0.50	0.41	0.37	0.34	0.29	0.20

Average Time Current Curves

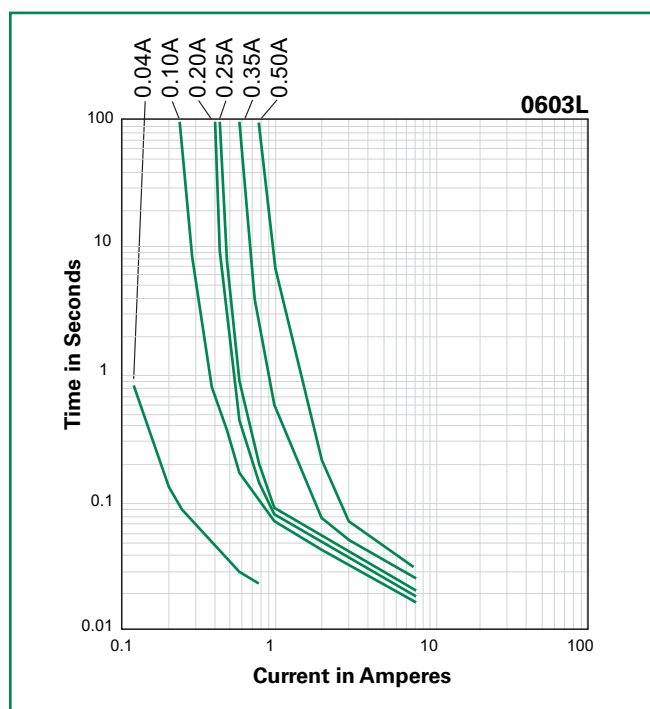

Temperature Rerating Curve

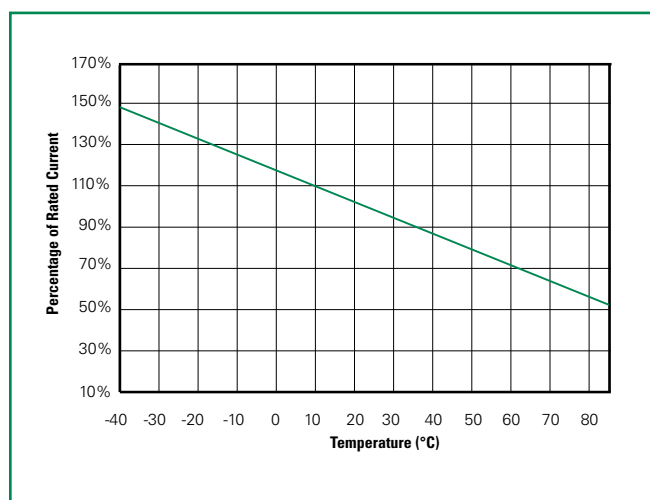

Note:
Typical Temperature rerating curve, refer to table for derating data

The average time current curves and Temperature Rerating curve performance is affected by a number of variables, and these curves provided as guidance only. Customer must verify the performance in their application.

Soldering Parameters

Profile Feature		Pb-Free Assembly
Average Ramp-Up Rate ($T_{S(max)}$ to T_P)		3°C/second max
Pre Heat:	Temperature Min ($T_{S(min)}$)	150°C
	Temperature Max ($T_{S(max)}$)	200°C
	Time (Min to Max) (t_s)	60 – 180 secs
Time Maintained Above:	Temperature (T_L)	217°C
	Temperature (t_L)	60 – 150 seconds
Peak / Classification Temperature (T_P)		260 ^{+0/-5} °C
Time within 5°C of actual peak Temperature (t_p)		20 – 40 seconds
Ramp-down Rate		6°C/second max
Time 25°C to peak Temperature (T_P)		8 minutes Max.

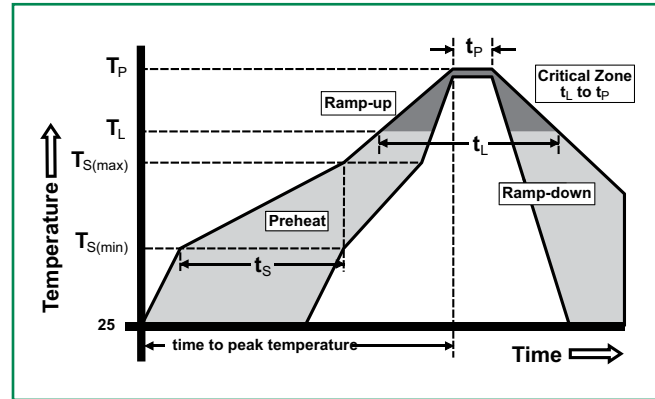

- All temperature refer to topside of the package, measured on the package body surface
- If reflow temperature exceeds the recommended profile, devices may not meet the performance requirements
- Recommended reflow methods: IR, vapor phase oven, hot air oven, N₂ environment for lead
- Recommended maximum paste thickness is 0.25mm (0.010inch)
- Devices can be cleaned using standard industry methods and solvents
- Devices can be reworked using the standard industry practices

Physical Specifications

Terminal Material	Solder-Plated Copper (Solder Material: Matte Tin (Sn))
Lead Solderability	Meets EIA Specification RS186-9E, ANSI/J-STD-002, Category 3.

Environmental Specifications

Operating/Storage Temperature	-40°C to +85°C
Maximum Device Surface Temperature in Tripped State	125°C
Passive Aging	+85°C, 1000 hours -/+10% typical resistance change
Humidity Aging	+85°C, 85% R.H., 100 hours -/+15% typical resistance change
Thermal Shock	MIL-STD-202, Method 107 +85°C/-40°C 20 times -30% typical resistance change
Solvent Resistance	MIL-STD-202, Method 215 No change
Vibration	MIL-STD-883, Method 2007, Condition A No change
Moisture Sensitivity Level	Level 1, J-STD-020

Dimensions

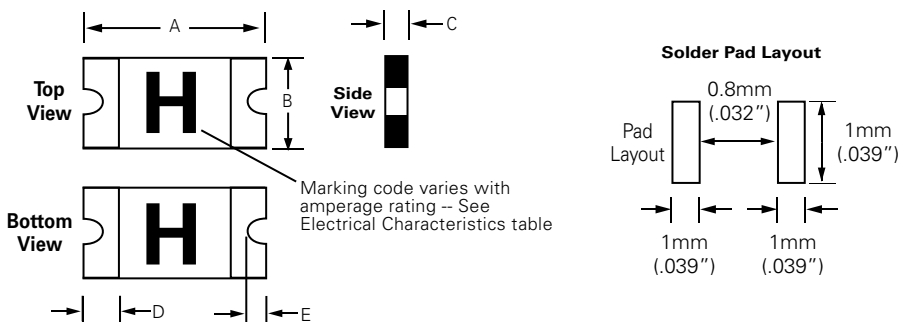

Part Number	A				B				C				D				E			
	Inch		mm		Inch		mm		Inch		mm		Inch		mm		Inch		mm	
	Min	Max	Min	Max	Min	Max	Min	Max	Min	Max	Min	Max	Min	Max	Min	Max	Min	Max	Min	Max
0603L004	.055	.071	1.40	1.80	.024	.039	0.60	1.00	.016	.030	0.40	0.75	.006	.020	0.15	0.50	.004	.016	0.10	0.40
0603L010	.055	.071	1.40	1.80	.024	.039	0.60	1.00	.016	.030	0.40	0.75	.006	.020	0.15	0.50	.004	.016	0.10	0.40
0603L020	.055	.071	1.40	1.80	.024	.039	0.60	1.00	.016	.030	0.40	0.75	.006	.020	0.15	0.50	.004	.016	0.10	0.40
0603L025	.055	.071	1.40	1.80	.024	.039	0.60	1.00	.016	.030	0.40	0.75	.006	.020	0.15	0.50	.004	.016	0.10	0.40
0603L035	.055	.071	1.40	1.80	.024	.039	0.60	1.00	.030	.061	0.75	1.55	.006	.020	0.15	0.50	.004	.016	0.10	0.40
0603L050	.055	.071	1.40	1.80	.024	.039	0.60	1.00	.030	.061	0.75	1.55	.006	.020	0.15	0.50	.004	.016	0.10	0.40

Part Ordering Number System

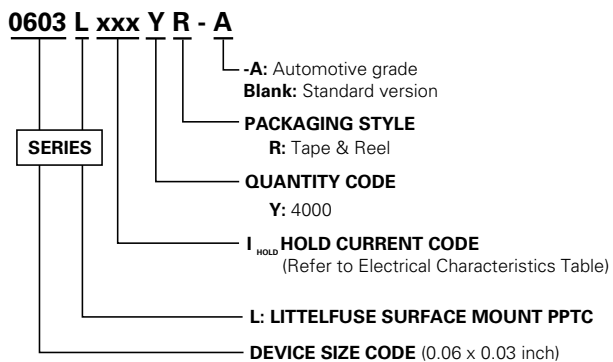

Packaging

Part Number	Ordering Number	Halogen Free	I_{hold} (A)	I_{hold} Code	Packaging Option	Quantity	Quantity & Packaging Codes
0603L004	0603L004YR	Yes	0.04	004	Tape and Reel	4000	YR
0603L010	0603L010YR	Yes	0.10	010	Tape and Reel	4000	YR
0603L020	0603L020YR	Yes	0.20	020	Tape and Reel	4000	YR
0603L025	0603L025YR	Yes	0.25	025	Tape and Reel	4000	YR
0603L035	0603L035YR	Yes	0.35	035	Tape and Reel	4000	YR
0603L050	0603L050YR	Yes	0.50	050	Tape and Reel	4000	YR

Tape and Reel Specifications

TAPE SPECIFICATIONS: EIA-481-1 (mm)		
	0603L004 0603L010 0603L020 0603L025	0603L035 0603L050
W	8.0+/- 0.30	8.0+/- 0.30
F	3.5+/- 0.05	3.5+/- 0.05
E₁	1.75+/- 0.10	1.75+/- 0.10
D₀	1.55+/- 0.05	1.55+/- 0.05
T	0.20+/- 0.10	0.20+/- 0.10
K₀	0.72+/- 0.10	0.96+/- 0.10
Leader min.	390	390
Trailer min.	160	160

REEL DIMENSIONS: EIA-481-1 (mm)	
C	Ø178+/-1.0
D	Ø60.2+/- 0.5
H	11.0+0.5
W	9.0+/- 1.5

Tape and Reel Diagram

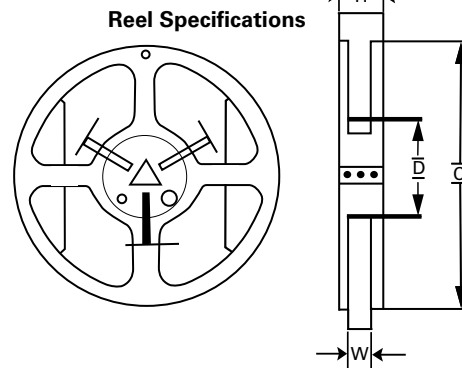
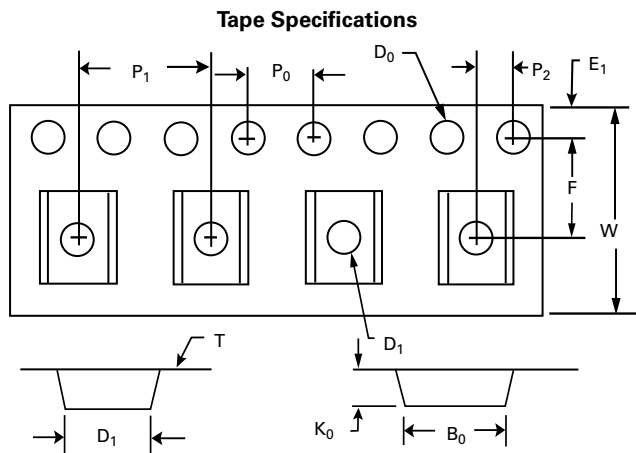

Disclaimer Notice - Information furnished is believed to be accurate and reliable. However, users should independently evaluate the suitability of and test each product selected for their own applications. Littelfuse products are not designed for, and may not be used in, all applications. Read complete Disclaimer Notice at www.littelfuse.com/disclaimer-electronics.

0805L Series



Description

The 0805L Series PTC provides surface mount overcurrent protection for applications where space is at a premium and resettable protection is desired.



Features

- RoHS compliant, lead-free and halogen-free
- Fast response to fault currents
- Compact design saves board space
- Low resistance
- Low-profile
- Compatible with high temperature solders

Applications

- USB peripherals
- Disk drives
- CD-ROMs
- Plug and play protection for motherboards and peripherals
- Mobile phones - battery and port protection
- Disk drives
- PDAs / digital cameras
- Game console port protection

Agency Approvals

AGENCY	AGENCY FILE NUMBER
	E183209
	R50119118

Additional Information



Datasheet





Resources



Samples

Electrical Characteristics

Part Number	Marking	I_{hold} (A)	I_{trip} (A)	V_{max} (Vdc)	I_{max} (A)	P_d typ. (W)	Maximum Time To Trip		Resistance		Agency Approvals	
							Current (A)	Time (Sec.)	R_{min} (Ω)	R_{1max} (Ω)		
0805L005/30	f3	0.05	0.15	30	40	0.50	0.25	1.50	3.600	20.000		
0805L010	A	0.10	0.30	15	100	0.5	0.50	1.50	1.000	6.000	x	x
0805L010/24	J	0.10	0.30	24	100	0.5	0.50	1.50	1.500	6.000	x	x
0805L020	C	0.20	0.50	9	100	0.5	8.00	0.02	0.650	3.500	x	x
0805L035	E	0.35	0.75	6	100	0.5	8.00	0.10	0.250	1.200	x	x
0805L050 ¹	F	0.50	1.00	6	100	0.5	8.00	0.10	0.150	0.850	x	x
0805L075	G	0.75	1.50	6	40	0.6	8.00	0.20	0.090	0.350	x	x
0805L100	N	1.00	1.95	6	40	0.6	8.00	0.30	0.060	0.210	x	x
0805L110	H	1.10	2.00	6	100	0.8	8.00	0.10	0.050	0.160	x	x

I_{hold} = Hold current: maximum current device will pass without tripping in 20°C still air.

I_{trip} = Trip current: minimum current at which the device will trip in 20°C still air.

V_{max} = Maximum voltage device can withstand without damage at rated current (I_{max})

I_{max} = Maximum fault current device can withstand without damage at rated voltage (V_{max})

P_d = Power dissipated from device when in the tripped state at 20°C still air.

R_{min} = Minimum resistance of device in initial (un-soldered) state.

R_{typ} = Typical resistance of device in initial (un-soldered) state.

R_{1max} = Maximum resistance of device at 20°C measured one hour after tripping or reflow soldering of 260°C for 20 sec.

Caution: Operation beyond the specified rating may result in damage and possible arcing and flame.

¹ Part Number tested and complied with AEC-Q200.

Temperature Derating

Part Number	Ambient Operation Temperature								
	-40°C	-20°C	0°C	20°C	40°C	50°C	60°C	70°C	85°C
0805L005/30	0.076	0.068	0.060	0.050	0.043	0.038	0.033	0.028	0.023
0805L010	0.14	0.12	0.11	0.10	0.08	0.07	0.06	0.05	0.03
0805L010/24	0.15	0.13	0.12	0.10	0.09	0.08	0.07	0.06	0.04
0805L020	0.28	0.25	0.23	0.20	0.17	0.14	0.12	0.10	0.07
0805L035	0.47	0.44	0.39	0.35	0.30	0.27	0.24	0.20	0.14
0805L050	0.68	0.62	0.55	0.50	0.40	0.37	0.33	0.29	0.23
0805L075	1.00	0.90	0.79	0.75	0.63	0.57	0.53	0.41	0.34
0805L100	1.35	1.25	1.10	1.00	0.82	0.74	0.65	0.55	0.42
0805L110	1.45	1.35	1.20	1.10	0.92	0.84	0.75	0.65	0.52

Notes: The temperature derating data is only for reference, please contact Littelfuse technical support for detail temperature derating information.

Average Time Current Curves

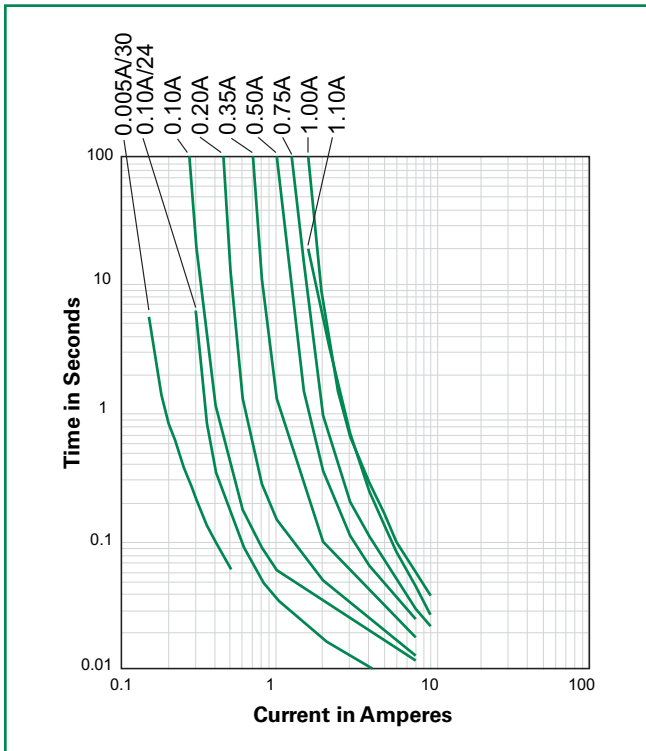

The average time current curves and Temperature Derating curve performance is affected by a number of variables, and these curves provided as guidance only. Customer must verify the performance in their application.

Temperature Derating Curve

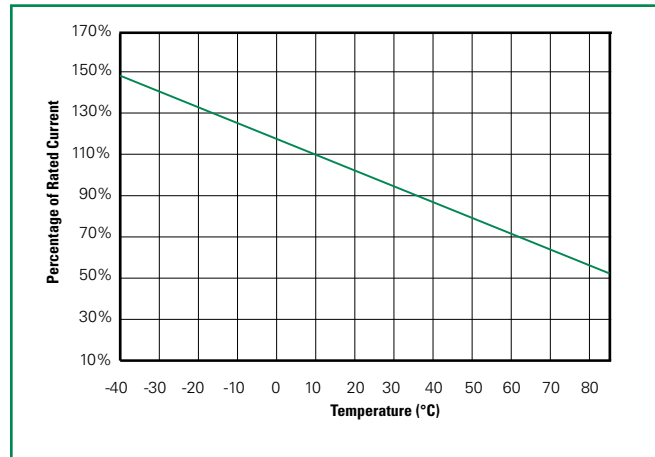

Note:
Typical Temperature derating curve, refer to table for derating data

Soldering Parameters

Profile Feature	Pb-Free Assembly	
Average Ramp-Up Rate ($T_{S(max)}$ to T_P)	3°C/second max	
Pre Heat:	Temperature Min ($T_{S(min)}$)	150°C
	Temperature Max ($T_{S(max)}$)	200°C
	Time (Min to Max) (t_s)	60 – 180 secs
Time Maintained Above:	Temperature (T_L)	217°C
	Temperature (t_L)	60 – 150 seconds
Peak / Classification Temperature (T_p)	260 ^{+0/-5} °C	
Time within 5°C of actual peak Temperature (t_p)	20 – 40 seconds	
Ramp-down Rate	6°C/second max	
Time 25°C to peak Temperature (T_p)	8 minutes Max.	

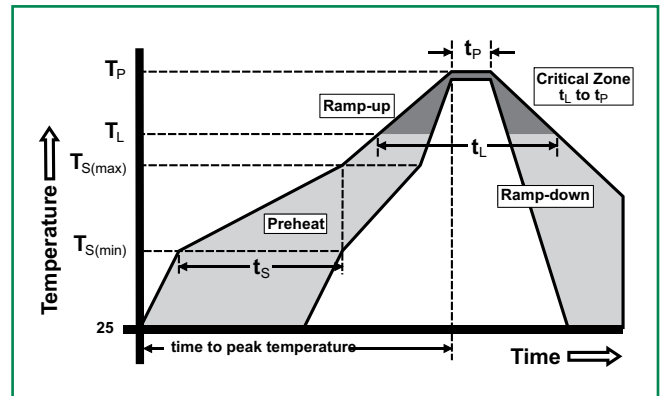

- All temperature refer to topside of the package, measured on the package body surface
- If reflow temperature exceeds the recommended profile, devices may not meet the performance requirements
- Recommended reflow methods: IR, vapor phase oven, hot air oven, N₂ environment for lead
- Recommended maximum paste thickness is 0.25mm (0.010inch)
- Devices can be cleaned using standard industry methods and solvents
- Devices can be reworked using the standard industry practices

Physical Specifications

Terminal Material	Solder-Plated Copper (Solder Material: Matte Tin (Sn))
Lead Solderability	Meets EIA Specification RS186-9E, ANSI/J-STD-002, Category 3

Environmental Specifications

Operating/Storage Temperature	-40°C to +85°C
Maximum Device Surface Temperature in Tripped State	125°C
Passive Aging	+85°C, 1000 hours -/+5% typical resistance change
Humidity Aging	+85°C, 85%, R.H., 1000 hours -/+5% typical resistance change
Thermal Shock	MIL-STD-202, Method 107 +85°C/-40°C 20 times -30% typical resistance change
Solvent Resistance	MIL-STD-202, Method 215 No change
Vibration	MIL-STD-883, Method 2007, Condition A No change
Moisture Sensitivity Level	Level 1, J-STD-020

Dimensions

MARKING CODE VARIES WITH AMPERAGE RATING (See Electrical Characteristic Table) SHOWN IS 1.0AMP RATING

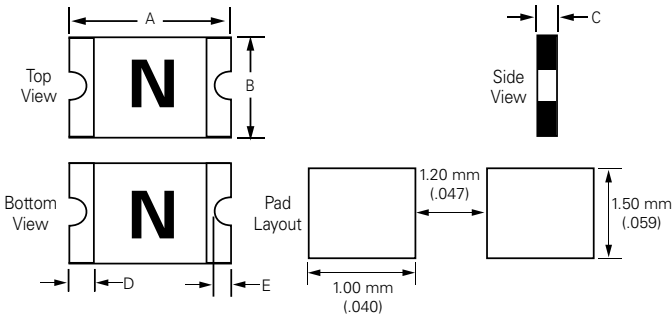

Part Number	A				B				C				D				E			
	Inches		mm		Inches		mm		Inches		mm		Inches		mm		Inches		mm	
	Min	Max	Min	Max	Min	Max	Min	Max	Min	Max	Min	Max	Min	Max	Min	Max	Min	Max	Min	Max
0805L005/30	0.08	0.09	2.00	2.20	0.05	0.06	1.20	1.50	0.03	0.05	0.75	1.25	0.01	0.02	0.20	0.55	0.002	0.02	0.05	0.45
0805L010	0.08	0.09	2.00	2.20	0.05	0.06	1.20	1.50	0.02	0.04	0.55	1.00	0.01	0.02	0.20	0.55	0.002	0.02	0.05	0.45
0805L010/24	0.08	0.09	2.00	2.20	0.05	0.06	1.20	1.50	0.02	0.04	0.55	1.00	0.01	0.02	0.20	0.55	0.002	0.02	0.05	0.45
0805L020	0.08	0.09	2.00	2.20	0.05	0.06	1.20	1.50	0.02	0.04	0.55	1.00	0.01	0.02	0.20	0.55	0.002	0.02	0.05	0.45
0805L035	0.08	0.09	2.00	2.20	0.05	0.06	1.20	1.50	0.02	0.03	0.45	0.75	0.01	0.02	0.20	0.55	0.002	0.02	0.05	0.45
0805L050	0.08	0.09	2.00	2.20	0.05	0.06	1.20	1.50	0.03	0.05	0.75	1.25	0.01	0.02	0.20	0.55	0.002	0.02	0.05	0.45
0805L075	0.08	0.09	2.00	2.20	0.05	0.06	1.20	1.50	0.03	0.05	0.75	1.25	0.01	0.02	0.20	0.55	0.002	0.02	0.05	0.45
0805L100	0.08	0.09	2.00	2.20	0.05	0.06	1.20	1.50	0.02	0.07	0.50	1.80	0.01	0.02	0.20	0.55	0.002	0.02	0.05	0.45
0805L110	0.08	0.09	2.00	2.20	0.05	0.06	1.20	1.50	0.03	0.06	0.80	1.40	0.01	0.02	0.20	0.55	0.002	0.02	0.05	0.45

Part Ordering Number System

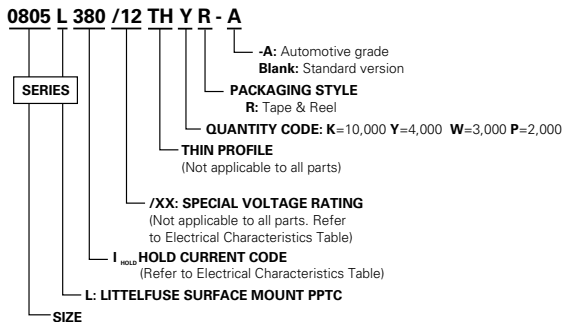

Packaging

Part Number	Ordering Number	Halogen Free	I _{hold} (A)	I _{hold} Code	Packaging Option	Quantity	Quantity & Packaging Codes
0805L005/30	0805L005/30YR	Yes	0.05	005	Tape and Reel	4000	YR
0805L010	0805L010YR	Yes	0.10	010	Tape and Reel	4000	YR
0805L010/24	0805L010/24YR	Yes	0.10	010	Tape and Reel	4,000	YR
0805L020	0805L020YR	Yes	0.20	020	Tape and Reel	4000	YR
0805L035	0805L035YR	Yes	0.35	035	Tape and Reel	4000	YR
0805L050	0805L050WR	Yes	0.50	050	Tape and Reel	3000	WR
0805L075	0805L075WR	Yes	0.75	075	Tape and Reel	3000	WR
0805L100	0805L100WR	Yes	1.00	100	Tape and Reel	3000	WR
0805L110	0805L110WR	Yes	1.10	110	Tape and Reel	3000	WR

Tape and Reel Specifications

TAPE SPECIFICATIONS: EIA-481-1 (mm)			
	0805L005/30 0805L010 0805L020 0805L035 0805L010/24	0805L050 0805L075 0805L100	0805L110
W	8.00+/-0.10	8.00+/-0.30	8.00+/-0.30
F	3.50+/-0.05	3.50+/-0.05	3.50+/-0.05
E₁	1.75+/-0.10	1.75+/-0.10	1.75+/-0.10
D₀	1.55+/-0.05	1.55+/-0.05	1.55+/-0.05
D₁	1.00 (min)	1.00+/-0.10	1.00+/-0.10
P₀	4.00+/-0.10	4.00+/-0.10	4.00+/-0.10
P₁	4.00+/-0.10	4.00+/-0.10	4.00+/-0.10
P₂	2.00+/-0.05	2.00+/-0.05	2.00+/-0.05
A₀	1.45+/-0.10	1.65+/-0.10	1.65+/-0.10
B₀	2.30+/-0.10	2.35+/-0.10	2.35+/-0.10
T	0.25+/-0.10	0.20+/-0.10	0.25+/-0.10
K₀	0.90+/-0.10	1.05+/-0.10	1.50+/-0.10
<i>Leader min.</i>	390	390	390
<i>Trailer min.</i>	160	160	160

REEL DIMENSIONS: EIA-481-1 (mm)	
C	Ø178+/-1.0
D	Ø60.2+0.5
H	11.0+/-0.5
W	9.0+/-1.5

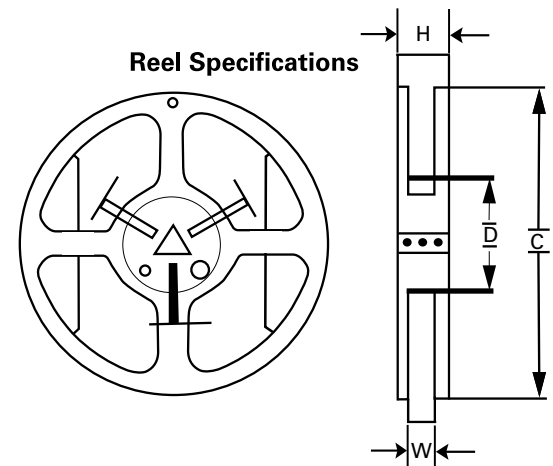
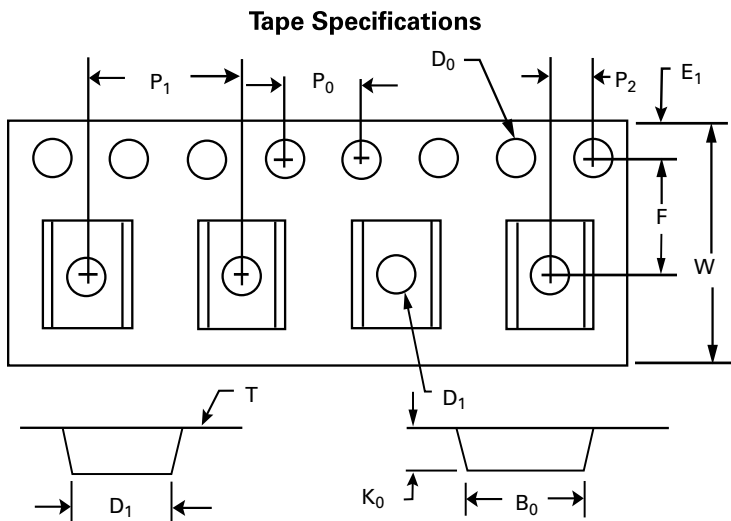

WARNING



- Users shall independently assess the suitability of these devices for each of their applications
- Operation of these devices beyond the stated maximum ratings could result in damage to the devices and lead to electrical arcing and/or fire
- These devices are intended to protect against the effects of temporary over-current or over-temperature conditions and are not intended to perform as protective devices where such conditions are expected to be repetitive or prolonged in duration
- Exposure to silicon-based oils, solvents, electrolytes, acids, and similar materials can adversely affect the performance of these PPTC devices
- These devices undergo thermal expansion under fault conditions, and thus shall be provided with adequate space and be protected against mechanical stresses
- Circuits with inductance may generate a voltage (L di/dt) above the rated voltage of the PPTC device.

Disclaimer Notice - Information furnished is believed to be accurate and reliable. However, users should independently evaluate the suitability of and test each product selected for their own applications. Littelfuse products are not designed for, and may not be used in, all applications. Read complete Disclaimer Notice at www.littelfuse.com/disclaimer-electronics.

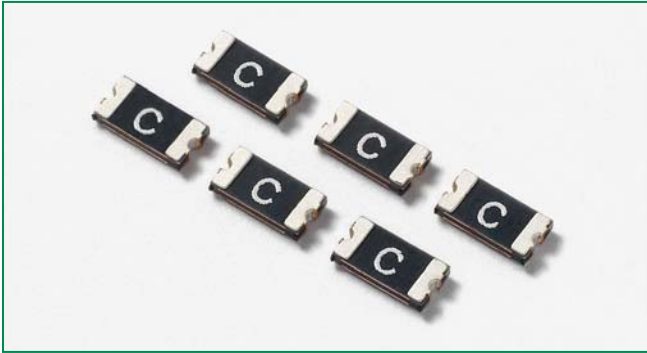
1206L Series



Agency Approvals

AGENCY	AGENCY FILE NUMBER
	E183209
	R50119118

Description

The 1206L Series PTC provides surface mount overcurrent protection for applications where space is at a premium and resettable protection is desired.

Features

- RoHS compliant, lead-free and halogen-free
- Fast response to fault currents
- Compact design saves board space
- Low resistance
- Low-profile
- Compatible with high temperature solders

Applications

- USB peripherals
- Disk drives
- CD-ROMs
- Plug and play protection for motherboards and peripherals
- Mobile phones - battery and port protection
- Disk drives
- PDAs / digital cameras
- Game console port protection

Electrical Characteristics

Part Number	Marking	I _{hold} (A)	I _{trip} (A)	V _{max} (Vdc)	I _{max} (A)	P _d typ. (W)	Maximum Time To Trip		Resistance		Agency Approvals	
							Current (A)	Time (Sec.)	R _{min} (Ω)	R _{1max} (Ω)		
1206L005/60	f6	0.05	0.15	60	10	0.6	0.25	1.50	3.60	20.00		
1206L010/60	n6	0.10	0.25	60	10	0.6	0.50	1.50	1.50	10.00		
1206L012	A	0.125	0.29	30	100	0.6	1.00	0.20	1.500	6.000	X	X
1206L016	B	0.16	0.37	30	100	0.6	1.00	0.30	1.200	4.500	X	X
1206L020 ^{1,2}	C	0.20	0.42	24	100	0.6	8.00	0.10	0.650	2.600	X	X
1206L025 ¹	D	0.25	0.50	16	100	0.6	8.00	0.08	0.550	2.300	X	X
1206L035 ¹	E	0.35	0.75	6	100	0.6	8.00	0.10	0.300	1.200	X	X
1206L035/16	J	0.35	0.75	16	100	0.6	8.00	0.10	0.300	1.200	X	X
1206L035/30	J3	0.35	0.75	30	100	0.6	8.00	0.10	0.30	1.20		
1206L050 ¹	F	0.50	1.00	6	100	0.6	8.00	0.10	0.150	0.700	X	X
1206L050/15	M	0.50	1.00	15	100	0.6	8.00	0.10	0.150	0.750	X	X
1206L050/24	F2	0.50	1.00	24	100	0.6	8.00	0.10	0.15	0.75		
1206L075/13.2	G1	0.75	1.50	13.2	100	0.6	8.00	0.20	0.090	0.350	X	X
1206L075/16	GF	0.75	1.50	16	100	0.6	8.00	0.20	0.090	0.2900	X	X
1206L075TH ¹	G	0.75	1.50	8	100	0.6	8.00	0.20	0.090	0.290	X	X
1206L110TH ¹	H	1.10	2.20	8	100	0.8	8.00	0.10	0.040	0.210	X	X
1206L150TH ¹	K	1.50	3.00	8	100	0.8	8.00	0.30	0.040	0.120	X	X
1206L175	V	1.75	3.50	6	100	0.8	8.00	0.50	0.020	0.090	X	X
1206L200	L	2.00	3.50	6	100	0.8	8.00	1.50	0.018	0.080	X	X

I_{hold} = Hold current: maximum current device will pass without tripping in 20°C still air.

I_{trip} = Trip current: minimum current at which the device will trip in 20°C still air.

V_{max} = Maximum voltage device can withstand without damage at rated current (I_{max})

I_{max} = Maximum fault current device can withstand without damage at rated voltage (V_{max})

P_d = Power dissipated from device when in the tripped state at 20°C still air.

R_{min} = Minimum resistance of device in initial (un-soldered) state.

R_{typ} = Typical resistance of device in initial (un-soldered) state.

R_{1max} = Maximum resistance of device at 20°C measured one hour after tripping or reflow soldering of 260°C for 20 sec.

Caution: Operation beyond the specified rating may result in damage and possible arcing and flame.

1 Some older references to these devices may include “-C” in the Part Number. The “-C” should be omitted when placing new orders for the device.

2 Part Number tested and complied with AEC-Q200.

Temperature Derating

Part Number	Ambient Operation Temperature								
	-40°C	-20°C	0°C	20°C	40°C	50°C	60°C	70°C	85°C
	Hold Current (A)								
1206L005/60	0.076	0.068	0.060	0.050	0.043	0.038	0.033	0.028	0.023
1206L010/60	0.15	0.14	0.12	0.10	0.084	0.075	0.065	0.055	0.042
1206L012	0.18	0.16	0.14	0.125	0.10	0.09	0.08	0.07	0.05
1206L016	0.22	0.20	0.18	0.16	0.14	0.12	0.10	0.09	0.08
1206L020	0.28	0.25	0.23	0.20	0.17	0.15	0.14	0.12	0.09
1206L025	0.37	0.33	0.29	0.25	0.22	0.20	0.17	0.15	0.12
1206L035	0.50	0.45	0.40	0.35	0.30	0.27	0.24	0.21	0.15
1206L035/16	0.50	0.45	0.40	0.35	0.30	0.27	0.24	0.21	0.15
1206L035/30	0.51	0.46	0.41	0.35	0.30	0.27	0.25	0.21	0.18
1206L050	0.71	0.64	0.57	0.50	0.42	0.39	0.35	0.31	0.25
1206L050/15	0.71	0.64	0.57	0.50	0.42	0.39	0.35	0.31	0.25
1206L050/24	0.76	0.68	0.60	0.50	0.43	0.38	0.33	0.29	0.24
1206L075/13.2	1.14	1.04	0.88	0.75	0.65	0.59	0.54	0.49	0.41
1206L075/16	1.01	0.94	0.86	0.75	0.65	0.60	0.54	0.46	0.37
1206L075TH	1.14	1.01	0.88	0.75	0.65	0.59	0.54	0.49	0.41
1206L110TH	1.64	1.46	1.30	1.10	0.92	0.83	0.80	0.65	0.52
1206L150TH	2.20	1.99	1.77	1.50	1.34	1.23	1.10	1.01	0.84
1206L175	2.50	2.25	2.00	1.75	1.55	1.45	1.35	1.25	1.10
1206L200	2.60	2.44	2.35	2.00	1.78	1.67	1.50	1.45	1.10

Notes: The temperature derating data is only for reference, please contact Littelfuse technical support for detail temperature derating information.

Average Time Current Curves

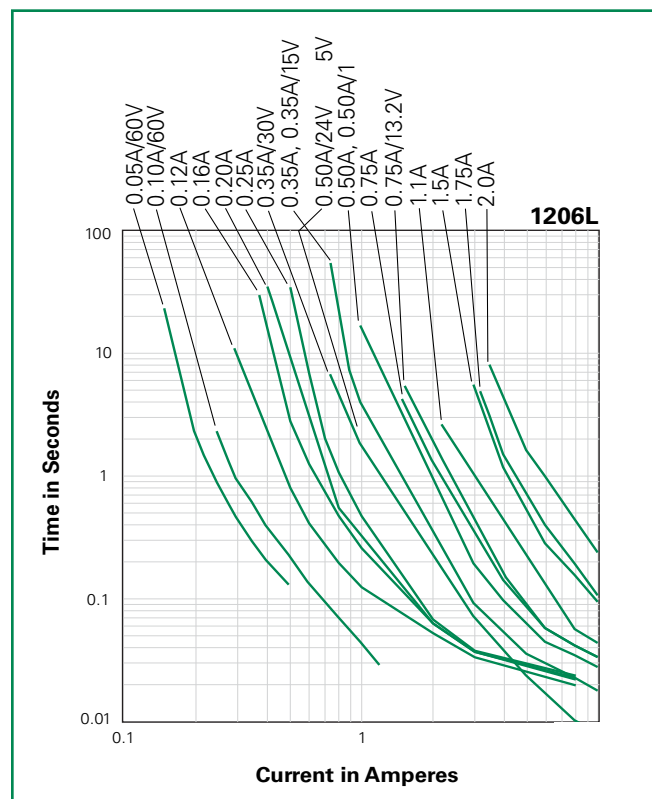

The average time current curves and Temperature Derating curve performance is affected by a number of variables, and these curves provided as guidance only. Customer must verify the performance in their application.

Temperature Derating Curve

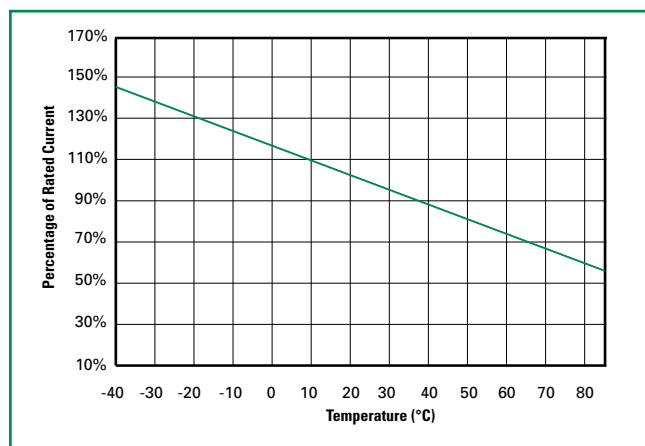

Additional Information



Datasheet



Resources



Samples

Soldering Parameters

Profile Feature		Pb-Free Assembly
Average Ramp-Up Rate ($T_{S(max)}$ to T_P)		3°C/second max
Pre Heat:	Temperature Min ($T_{S(min)}$)	150°C
	Temperature Max ($T_{S(max)}$)	200°C
	Time (Min to Max) (t_s)	60 – 180 secs
Time Maintained Above:	Temperature (T_L)	217°C
	Temperature (t_L)	60 – 150 seconds
Peak / Classification Temperature (T_P)		260 ^{+0/-5} °C
Time within 5°C of actual peak Temperature (t_p)		20 – 40 seconds
Ramp-down Rate		6°C/second max
Time 25°C to peak Temperature (T_P)		8 minutes Max.

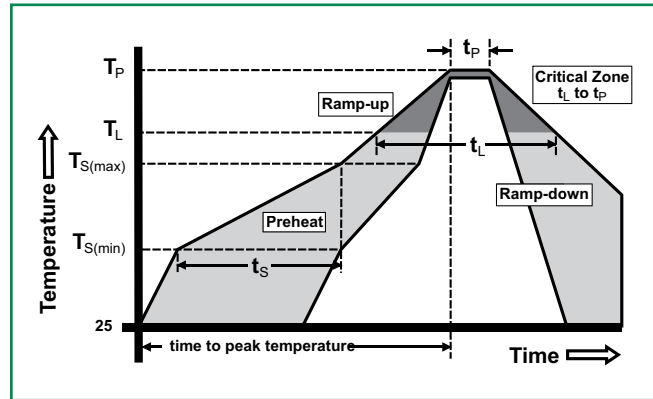

- All temperature refer to topside of the package, measured on the package body surface
- If reflow temperature exceeds the recommended profile, devices may not meet the performance requirements
- Recommended reflow methods: IR, vapor phase oven, hot air oven, N₂ environment for lead
- Recommended maximum paste thickness is 0.25mm (0.010inch)
- Devices can be cleaned using standard industry methods and solvents
- Devices can be reworked using the standard industry practices

Physical Specifications

Terminal Material	Solder-Plated Copper (Solder Material: Matte Tin (Sn))
Lead Solderability	Meets EIA Specification RS186-9E, ANSI/J-STD-002 Category 3.

Environmental Specifications

Operating/Storage Temperature	-40°C to +85°C
Maximum Device Surface Temperature in Tripped State	125°C
Passive Aging	+85°C, 1000 hours -/+5% typical resistance change
Humidity Aging	+85°C, 85%, R.H., 1000 hours -/+5% typical resistance change
Thermal Shock	MIL-STD-202, Method 107 +85°C/-40°C 20 times -30% typical resistance change
Solvent Resistance	MIL-STD-202, Method 215 No change
Vibration	MIL-STD-883, Method 2007, Condition A No change
Moisture Sensivity Level	Level 1, J-STD-020

Dimensions

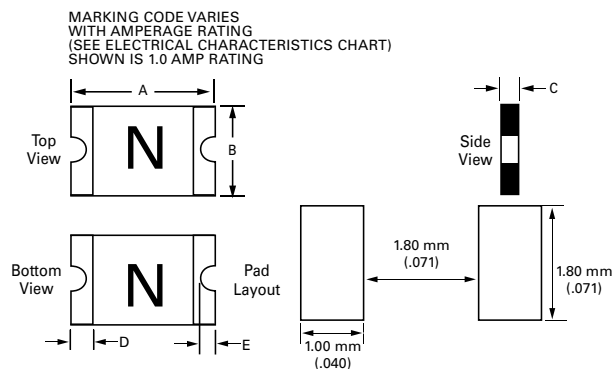

Part Number	A				B				C				D				E				
	Inches		mm		Inches		mm		Inches		mm		Inches		mm		Inches		mm		
	Min	Max	Min	Max	Min	Max	Min	Max	Min	Max	Min	Max	Min	Max	Min	Max	Min	Max	Min	Max	
1206L005/60									0.03	0.05	0.65	1.25									
1206L010/60									0.03	0.05	0.65	1.25									
1206L012									0.03	0.06	0.65	1.45									
1206L016									0.03	0.06	0.65	1.45									
1206L020									0.02	0.04	0.50	1.00									
1206L025									0.02	0.04	0.5	1.00									
1206L035									0.02	0.03	0.45	0.75									
1206L035/16									0.02	0.03	0.45	0.75									
1206L035/30									0.02	0.04	0.50	1.00									
1206L050									0.02	0.03	0.45	0.75									
1206L050/15	0.12	0.13	3.00	3.40	0.06	0.07	1.50	1.80	0.02	0.03	0.45	0.75	0.01	0.03	0.25	0.75	0.002	0.018	0.05	0.45	
1206L050/24									0.03	0.05	0.75	1.25									
1206L075/13.2									0.03	0.05	0.75	1.25									
1206L075/16									0.03	0.05	0.75	1.25									
1206L075TH									0.02	0.03	0.40	0.75									
1206L110TH									0.01	0.02	0.30	0.60									
1206L150TH									0.02	0.04	0.50	1.00									
1206L175									0.03	0.08	0.80	1.80									
1206L200									0.03	0.07	0.80	1.60									

WARNING

- Users shall independently assess the suitability of these devices for each of their applications
- Operation of these devices beyond the stated maximum ratings could result in damage to the devices and lead to electrical arcing and/or fire
- These devices are intended to protect against the effects of temporary over-current or over-temperature conditions and are not intended to perform as protective devices where such conditions are expected to be repetitive or prolonged in duration
- Exposure to silicon-based oils, solvents, electrolytes, acids, and similar materials can adversely affect the performance of these PPTC devices
- These devices undergo thermal expansion under fault conditions, and thus shall be provided with adequate space and be protected against mechanical stresses
- Circuits with inductance may generate a voltage (L di/dt) above the rated voltage of the PPTC device.

Part Ordering Number System

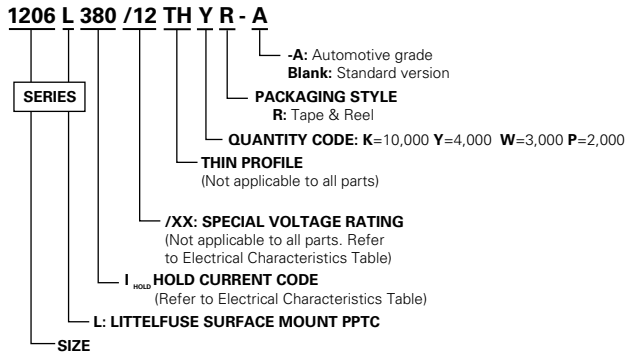

Packaging Options

Part Number	Ordering Number	Halogen Free	I_{hold} (A)	I_{hold} Code	Packaging Option	Quantity	Quantity/Pack Code
1206L005/60	1206L005/60WR	Yes	0.05	050	Tape and Reel	3000	WR
1206L010/60	1206L010/60WR	Yes	0.10	100	Tape and Reel	3000	WR
1206L012	1206L012WR	Yes	0.125	012	Tape and Reel	3000	WR
1206L016	1206L016WR	Yes	0.16	016	Tape and Reel	3000	WR
1206L020	1206L020YR	Yes	0.20	020	Tape and Reel	4000	YR
1206L025	1206L025YR	Yes	0.25	025	Tape and Reel	4000	YR
1206L035	1206L035YR	Yes	0.35	035	Tape and Reel	4000	YR
1206L035/16	1206L035/16YR	Yes	0.35	035	Tape and Reel	4000	YR
1206L035/30	1206L035/30WR	Yes	0.35	350	Tape and Reel	3000	WR
1206L050	1206L050YR	Yes	0.50	050	Tape and Reel	4000	YR
1206L050/15	1206L050/15YR	Yes	0.50	050	Tape and Reel	4000	YR
1206L050/24	1206L050/24WR	Yes	0.50	500	Tape and Reel	3000	WR
1206L075/13.2	1206L075/13.2WR	Yes	0.75	075	Tape and Reel	3000	WR
1206L075/16	1206L075/16WR	Yes	0.08	75	Tape and Reel	3,000	WR
1206L075TH	1206L075THYR	Yes	0.75	075	Tape and Reel	4000	YR
1206L110TH	1206L110THYR	Yes	1.10	110	Tape and Reel	4000	YR
1206L150TH	1206L150THWR	Yes	1.50	150	Tape and Reel	3000	WR
1206L175	1206L175PR	Yes	1.75	175	Tape and Reel	2000	PR
1206L200	1206L200PR	Yes	2.00	200	Tape and Reel	2000	PR

Tape and Reel Specifications

TAPE SPECIFICATIONS: EIA-481-1 (mm)			
	Packaging Code "YR":	Packaging Code "WR":	Packaging Code "PR":
	1206L020	1206L005/60	1206L175
	1206L025	1206L010/60	1206L200
	1206L035	1206L012	
	1206L035/16	1206L016	
	1206L050	1206L035/30	
	1206L050/15	1206L050/15	
	1206L075TH	1206L050/24	
	1206L110TH	1206L075/13.6	
		1206L150TH	
W	8.20+0.10/-0.30	8.15+0.15/-0.30	8.20+0.10/-0.30
F	3.50+/-0.05	3.50+/-0.05	3.50+/-0.05
E₁	1.75+/-0.10	1.75+/-0.10	1.75+/-0.10
D₀	1.55+/-0.05	1.55+/-0.05	1.55+/-0.05
D₁	1.00+/-0.10	1.00+/-0.10	1.00+/-0.10
P₀	4.00+/-0.10	4.00+/-0.10	4.00+/-0.10
P₁	4.00+/-0.10	4.00+/-0.10	4.00+/-0.10
P₂	2.00+/-0.05	2.00+/-0.05	2.00+/-0.05
A₀	1.95+/-0.10	1.95+/-0.10	1.95+/-0.10
B₀	3.65+/-0.10	3.65+/-0.10	3.65+/-0.10
T	0.25+/-0.10	0.25+/-0.10	0.25+/-0.10
K₀	0.87+/-0.10	1.30+/-0.10	1.70+/-0.10
Leader min.	390	390	390
Trailer min.	160	160	160

REEL DIMENSIONS: EIA-481-1 (mm)	
C	Ø178+/-1.0
D	Ø60.2+/-0.5
H	11.0+/-0.5
W	9.0+/-1.5

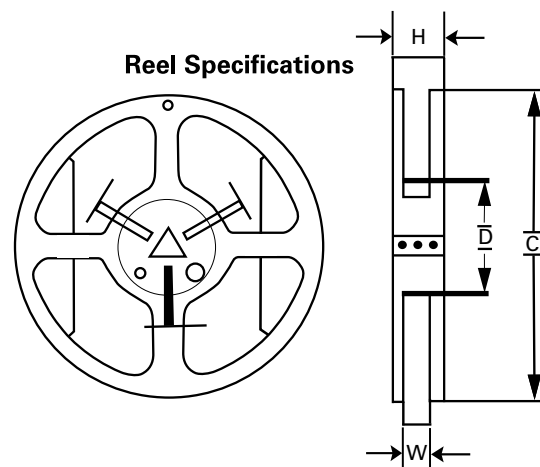
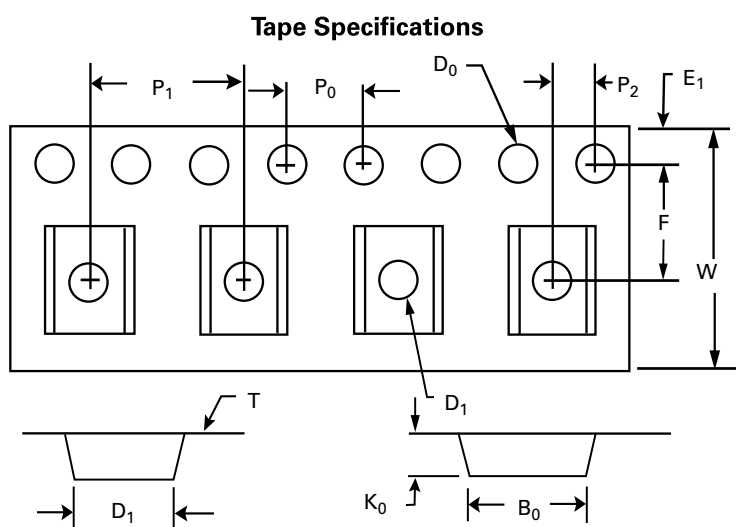

Disclaimer Notice - Information furnished is believed to be accurate and reliable. However, users should independently evaluate the suitability of and test each product selected for their own applications. Littelfuse products are not designed for, and may not be used in, all applications. Read complete Disclaimer Notice at www.littelfuse.com/disclaimer-electronics.

1210L Series

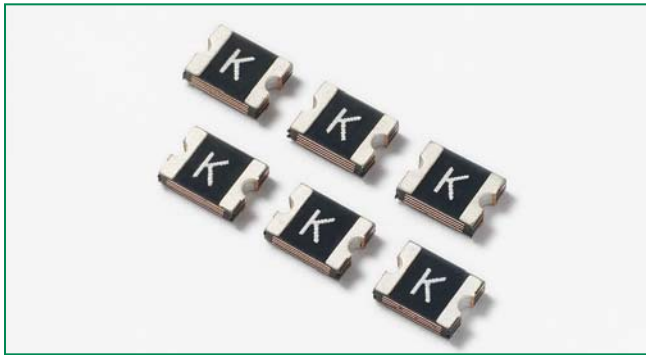

Description

The 1210L Series PTC provides surface mount overcurrent protection for applications where space is at a premium and resettable protection is desired.



Features

- RoHS compliant, lead-free and halogen-free
- Fast response to fault currents
- Compact design saves board space
- Low resistance
- Low-profile
- Compatible with high temperature solders

Applications

- USB peripherals
- Disk drives
- CD-ROMs
- PC motherboards - plug and play protection
- Mobile phones - battery and port protection
- PDAs / digital cameras
- Game console port protection

Agency Approvals

AGENCY	AGENCY FILE NUMBER
	E183209
	R50119118

Additional Information



Datasheet





Resources



Samples

Electrical Characteristics

Part Number	Marking	I _{hold} (A)	I _{trip} (A)	V _{max} (Vdc)	I _{max} (A)	P _d typ. (W)	Maximum Time To Trip		Resistance		Agency Approvals	
							Current (A)	Time (Sec.)	R _{min} (Ω)	R _{1max} (Ω)		
1210L005	A	0.05	0.15	30	10	0.60	0.25	1.50	3.600	50.00	X	X
1210L010	B	0.10	0.30	30	10	0.60	0.50	1.50	1.600	15.00	X	X
1210L020	C	0.20	0.40	30	10	0.60	8.00	0.02	0.800	5.000	X	X
1210L035	E	0.35	0.70	6	100	0.60	8.00	0.20	0.320	1.300	X	X
1210L035/30	E3	0.35	0.70	30	40	0.60	8.00	0.20	0.320	1.300		
1210L050	F	0.50	1.00	13.2	100	0.60	8.00	0.05	0.250	0.900	X	X
1210L050/30	F3	0.50	1.00	30	40	0.60	8.00	0.15	0.220	0.900		
1210L075	G	0.75	1.50	6	100	0.60	8.00	0.10	0.130	0.400	X	X
1210L075/24	G2	0.75	1.50	24	100	0.60	8.00	0.10	0.130	0.400	X	X
1210L110/12	H1	1.10	2.20	12	100	0.6	8.00	0.10	0.060	0.210	X	X
1210L110/16	HF	1.10	2.20	16	100	0.6	8.00	0.10	0.060	0.210	X	X
1210L110TH	H	1.10	2.20	8	100	0.60	8.00	0.10	0.060	0.210	X	X
1210L150/16	KF	1.50	3.00	16	100	0.80	8.00	0.30	0.040	0.110		
1210L150TH	K	1.50	3.00	6	100	0.80	8.00	0.30	0.040	0.110	X	X
1210L175	V	1.75	3.50	6	100	0.80	8.00	0.60	0.020	0.080	X	X
1210L200	L	2.00	4.00	6	100	0.80	8.00	1.00	0.015	0.070	X	X

I_{hold} = Hold current: maximum current device will pass without tripping in 20°C still air.

I_{trip} = Trip current: minimum current at which the device will trip in 20°C still air.

V_{max} = Maximum voltage device can withstand without damage at rated current (I_{max})

I_{max} = Maximum fault current device can withstand without damage at rated voltage (V_{max})

P_d = Power dissipated from device when in the tripped state at 20°C still air.

R_{min} = Minimum resistance of device in initial (un-soldered) state.

R_{typ} = Typical resistance of device in initial (un-soldered) state.

R_{1max} = Maximum resistance of device at 20°C measured one hour after tripping or reflow soldering of 260°C for 20 sec.

Caution: Operation beyond the specified rating may result in damage and possible arcing and flame.

Temperature Derating

Part Number	Ambient Operation Temperature								
	-40°C	-20°C	0°C	20°C	40°C	50°C	60°C	70°C	85°C
	Hold Current (A)								
1210L005	0.08	0.07	0.06	0.05	0.04	0.04	0.03	0.03	0.02
1210L010	0.16	0.14	0.12	0.10	0.08	0.07	0.06	0.05	0.03
1210L020	0.29	0.26	0.22	0.20	0.16	0.14	0.13	0.11	0.08
1210L035	0.47	0.45	0.40	0.35	0.33	0.28	0.24	0.21	0.18
1210L035/30	0.53	0.46	0.42	0.35	0.30	0.26	0.25	0.22	0.19
1210L050	0.76	0.67	0.58	0.50	0.43	0.40	0.36	0.32	0.28
1210L050/30	0.75	0.67	0.59	0.50	0.42	0.39	0.36	0.31	0.25
1210L075	1.00	0.97	0.86	0.75	0.64	0.59	0.54	0.48	0.40
1210L075/24	1.00	0.97	0.86	0.75	0.64	0.59	0.54	0.48	0.40
1210L110/12	1.65	1.47	1.27	1.10	0.92	0.83	0.73	0.63	0.52
1210L110/16	1.65	1.47	1.27	1.10	0.92	0.83	0.73	0.63	0.52
1210L110TH	1.60	1.42	1.26	1.10	0.94	0.86	0.80	0.70	0.58
1210L150/16	2.19	1.97	1.74	1.50	1.31	1.17	1.05	0.93	0.78
1210L150TH	2.30	2.02	1.76	1.50	1.24	1.11	1.00	0.85	0.65
1210L175	2.45	2.22	2.01	1.75	1.45	1.26	1.10	0.98	0.80
1210L200	2.60	2.44	2.35	2.00	1.78	1.67	1.50	1.45	1.10

Note:

The temperature derating data is only for reference, please contact Littelfuse technical support for detail temperature derating information.

Average Time Current Curves

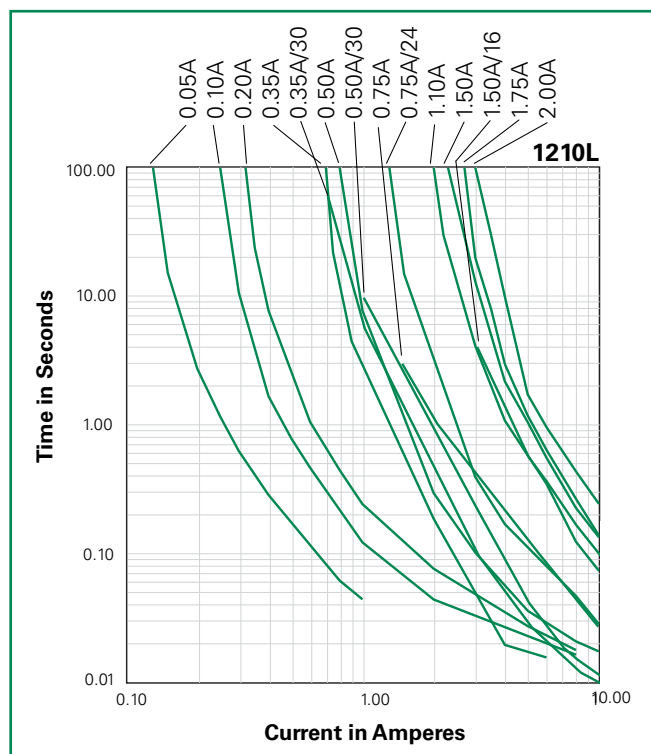

The average time current curves and Temperature Derating curve performance is affected by a number of variables, and these curves provided as guidance only. Customer must verify the performance in their application.

Temperature Derating Curve

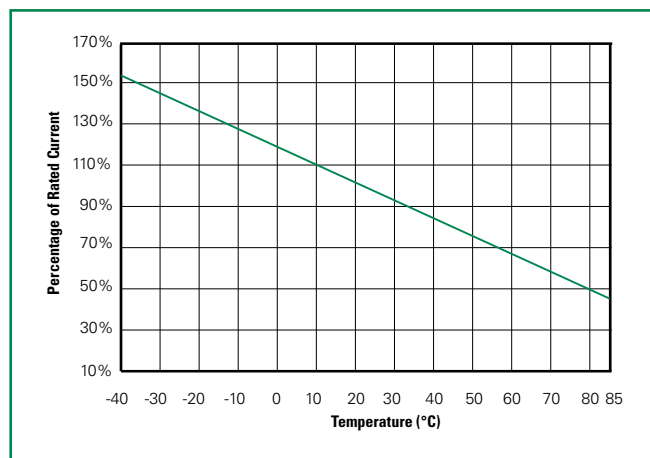

Note:

Typical Temperature derating curve, refer to table for derating data

Soldering Parameters

Profile Feature	Pb-Free Assembly	
Average Ramp-Up Rate ($T_{S(max)}$ to T_P)	3°C/second max	
Pre Heat:	Temperature Min ($T_{S(min)}$)	150°C
	Temperature Max ($T_{S(max)}$)	200°C
	Time (Min to Max) (t_s)	60 – 180 secs
Time Maintained Above:	Temperature (T_L)	217°C
	Temperature (t_L)	60 – 150 seconds
Peak / Classification Temperature (T_P)	260 ^{+0/-5} °C	
Time within 5°C of actual peak Temperature (t_p)	20 – 40 seconds	
Ramp-down Rate	6°C/second max	
Time 25°C to peak Temperature (T_P)	8 minutes Max.	

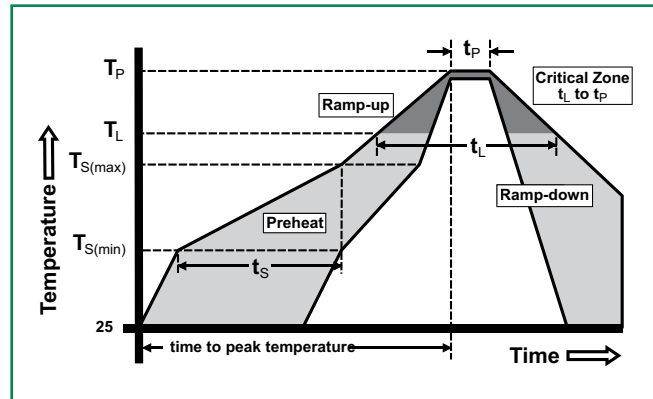

- All temperature refer to topside of the package, measured on the package body surface
- If reflow temperature exceeds the recommended profile, devices may not meet the performance requirements
- Recommended reflow methods: IR, vapor phase oven, hot air oven, N₂ environment for lead
- Recommended maximum paste thickness is 0.25mm (0.010inch)
- Devices can be cleaned using standard industry methods and solvents
- Devices can be reworked using the standard industry practices

Physical Specifications

Terminal Material	Solder-Plated Copper (Solder Material: Matte Tin (Sn))
Lead Solderability	Meets EIA Specification RS186-9E, ANSI/J-STD-002 Category 3.

Environmental Specifications

Operating/Storage Temperature	-40°C to +85°C
Maximum Device Surface Temperature in Tripped State	125°C
Passive Aging	+85°C, 1000 hours -/+5% typical resistance change
Humidity Aging	+85°C, 85, R.H., 1000 hours -/+5% typical resistance change
Thermal Shock	MIL-STD-202, Method 107 +85°C/-40°C, 20 times -30% typical resistance change
Solvent Resistance	MIL-STD-202, Method 215 No change
Vibration	MIL-STD-883, Method 2007, Condition A No change
Moisture Level Sensitivity	Level 1, J-STD-020

Dimensions

MARKING CODE VARIES
 WITH AMPERAGE RATING
 (See Electrical Characteristics Table)
 SHOWN IS 1.5AMP RATING

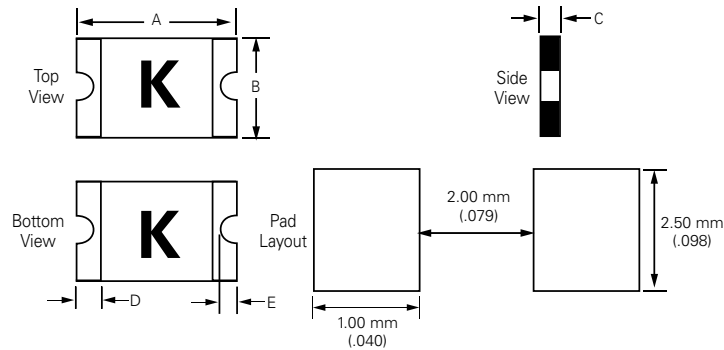

Part Number	A				B				C				D				E			
	Inches		mm		Inches		mm		Inches		mm		Inches		mm		Inches		mm	
	Min	Max	Min	Max	Min	Max	Min	Max	Min	Max	Min	Max	Min	Max	Min	Max	Min	Max	Min	Max
1210L005	0.12	0.14	3.0	3.43	0.09	0.11	2.35	2.80	0.03	0.05	0.75	1.25	0.01	0.03	0.25	0.75	0.004	0.02	0.10	0.50
1210L010	0.12	0.14	3.0	3.43	0.09	0.11	2.35	2.80	0.03	0.05	0.75	1.25	0.01	0.03	0.25	0.75	0.004	0.02	0.10	0.50
1210L020	0.12	0.14	3.0	3.43	0.09	0.11	2.35	2.80	0.02	0.04	0.60	1.00	0.01	0.03	0.25	0.75	0.004	0.02	0.10	0.50
1210L035	0.12	0.14	3.0	3.43	0.09	0.11	2.35	2.80	0.02	0.03	0.50	0.85	0.01	0.03	0.25	0.75	0.004	0.02	0.10	0.50
1210L035/30	0.12	0.14	3.00	3.43	0.09	0.11	2.35	2.80	0.03	0.05	0.75	1.25	0.01	0.03	0.25	0.75	0.004	0.02	0.10	0.50
1210L050	0.12	0.14	3.0	3.43	0.09	0.11	2.35	2.80	0.02	0.03	0.50	0.85	0.01	0.03	0.25	0.75	0.004	0.02	0.10	0.50
1210L050/30	0.12	0.14	3.00	3.43	0.09	0.11	2.35	2.80	0.03	0.05	0.75	1.25	0.01	0.03	0.25	0.75	0.004	0.02	0.10	0.50
1210L075	0.12	0.14	3.0	3.43	0.09	0.11	2.35	2.80	0.02	0.03	0.50	0.85	0.01	0.03	0.25	0.75	0.004	0.02	0.10	0.50
1210L075/24	0.12	0.14	3.0	3.43	0.09	0.11	2.35	2.80	0.05	0.07	1.20	1.80	0.01	0.03	0.25	0.75	0.004	0.02	0.10	0.50
1210L110/12	0.12	0.14	3.0	3.43	0.09	0.11	2.35	2.80	0.03	0.05	0.75	1.25	0.01	0.03	0.25	0.75	0.004	0.02	0.10	0.50
1210L110/16	0.12	0.14	3.0	3.43	0.09	0.11	2.35	2.80	0.03	0.05	0.75	1.25	0.01	0.03	0.25	0.75	0.004	0.02	0.10	0.50
1210L110TH	0.12	0.14	3.0	3.43	0.09	0.11	2.35	2.80	0.04	0.05	0.30	0.71	0.01	0.03	0.25	0.75	0.004	0.02	0.10	0.50
1210L150/16	0.12	0.14	3.00	3.43	0.09	0.11	2.35	2.80	0.03	0.05	0.75	1.25	0.01	0.03	0.25	0.75	0.004	0.02	0.10	0.50
1210L150TH	0.12	0.14	3.0	3.43	0.09	0.11	2.35	2.80	0.03	0.07	0.75	1.07	0.01	0.03	0.25	0.75	0.004	0.02	0.10	0.50
1210L175	0.12	0.14	3.0	3.43	0.09	0.11	2.35	2.80	0.02	0.04	0.60	1.00	0.01	0.03	0.25	0.75	0.004	0.02	0.10	0.50
1210L200	0.12	0.14	3.0	3.43	0.09	0.11	2.35	2.80	0.03	0.06	0.80	1.60	0.01	0.03	0.25	0.75	0.004	0.02	0.10	0.50

Part Ordering Number System

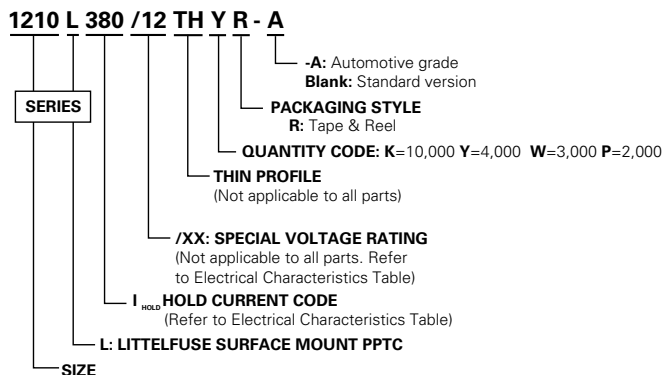

Packaging Options

Part Number	Ordering Number	Halogen Free	I _{hold} (A)	I _{hold} Code	Packaging Option	Quantity	Quantity & Packaging Codes
1210L005	1210L005WR	Yes	0.05	005	Tape and Reel	3000	WR
1210L010	1210L010WR	Yes	0.10	010	Tape and Reel	3000	WR
1210L020	1210L020WR	Yes	0.20	020	Tape and Reel	3000	WR
1210L035	1210L035YR	Yes	0.35	035	Tape and Reel	4000	YR
1210L035/30	1210L035/30WR	Yes	0.35	035	Tape and Reel	3,000	WR
1210L050	1210L050YR	Yes	0.50	050	Tape and Reel	4000	YR
1210L050/30	1210L050/30WR	Yes	0.50	050	Tape and Reel	3,000	WR
1210L075	1210L075YR	Yes	0.75	075	Tape and Reel	4000	YR
1210L075/24	1210L075/24PR	Yes	0.75	075	Tape and Reel	2000	PR
1210L110/12	1210L110/12WR	Yes	1.10	110	Tape and Reel	3,000	WR
1210L110/16	1210L110/16WR	Yes	1.10	110	Tape and Reel	3,000	WR
1210L110TH	1210L110THYR	Yes	1.10	110	Tape and Reel	4000	YR
1210L150/16	1210L150/16WR	Yes	1.50	150	Tape and Reel	3,000	WR
1210L150TH	1210L150THWR	Yes	1.50	150	Tape and Reel	3000	WR
1210L175	1210L175WR	Yes	1.75	175	Tape and Reel	3000	WR
1210L200	1210L200PR	Yes	2.00	200	Tape and Reel	2000	PR

Tape and Reel Specifications

TAPE SPECIFICATIONS: EIA-481-1 (mm)				
	Packaging Code "YR": 1210L035 1210L050 1210L075 1210L110TH	Packaging Code "WR": 1210L005 1210L010 1210L020 1210L035/30 1210L050/30 1210L110/12 1210L110/16 1210L150/16 1210L150TH 1210L175	Packaging Code "PR": 1210L200	Packaging Code "PR": 1210L075/24
W	8.00+/-0.30	8.00+/-0.30	8.00+/-0.30	8.00+/-0.30
F	3.50+/-0.05	3.50+/-0.05	3.50+/-0.05	3.50+/-0.05
E₁	1.75+/-0.10	1.75+/-0.10	1.75+/-0.10	1.75+/-0.10
D₀	1.55+/-0.05	1.55+/-0.05	1.55+/-0.05	1.55+/-0.05
D₁	1.00 (min)	1.00 (min)	1.00 (min)	1.00+0.25/-0
P₀	4.00+/-0.10	4.00+/-0.10	4.00+/-0.10	4.00+/-0.10
P₁	4.00+/-0.10	4.00+/-0.10	4.00+/-0.10	4.00+/-0.10
P₂	2.00+/-0.05	2.00+/-0.05	2.00+/-0.05	2.00+/-0.05
A₀	2.82+/-0.10	2.82+/-0.10	2.80+/-0.10	2.80+/-0.10
B₀	3.46+/-0.10	3.50+/-0.10	3.50+/-0.10	3.55+/-0.10
T	0.25+/-0.10	0.20+/-0.10	0.25+/-0.10	0.25+/-0.10
K₀	1.00+/-0.10	1.30+/-0.10	1.60+/-0.10	1.75+/-0.10
<i>Leader min.</i>	390	390	390	390
<i>Trailer min.</i>	160	160	160	160

REEL DIMENSIONS: EIA-481-1 (mm)	
C	Ø178+/-1.0
D	Ø60.2+/-0.5
H	11.0+/-0.05
W	9.0+/-1.5

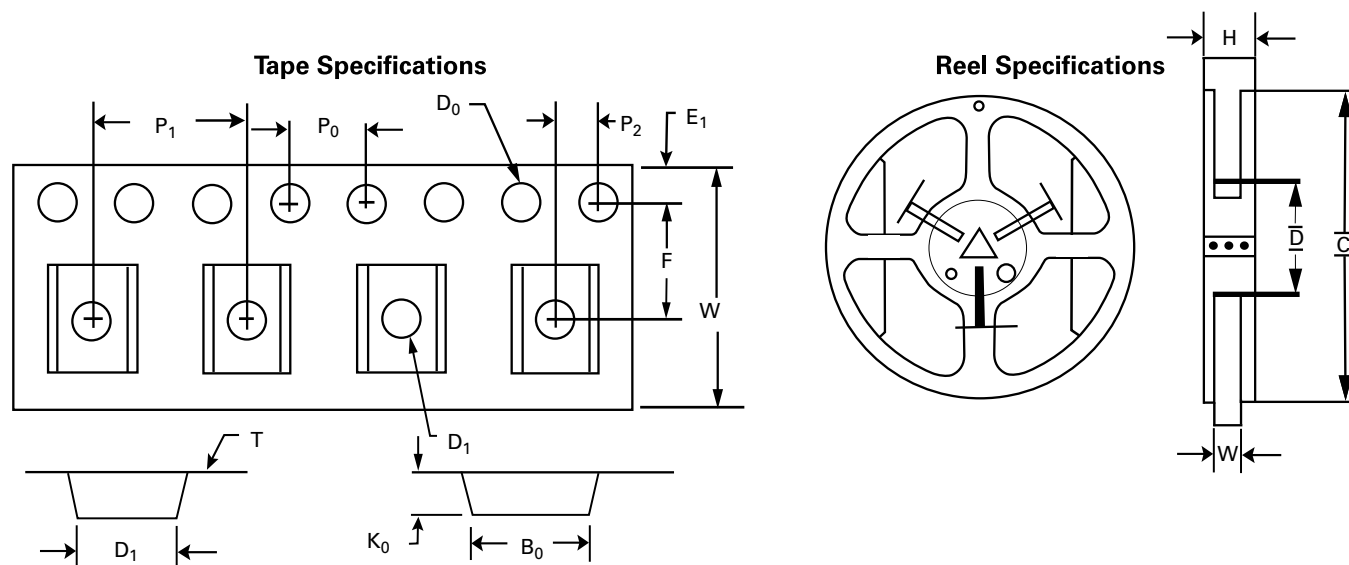

WARNING

- Users shall independently assess the suitability of these devices for each of their applications
- Operation of these devices beyond the stated maximum ratings could result in damage to the devices and lead to electrical arcing and/or fire
- These devices are intended to protect against the effects of temporary over-current or over-temperature conditions and are not intended to perform as protective devices where such conditions are expected to be repetitive or prolonged in duration
- Exposure to silicon-based oils, solvents, electrolytes, acids, and similar materials can adversely affect the performance of these PPTC devices
- These devices undergo thermal expansion under fault conditions, and thus shall be provided with adequate space and be protected against mechanical stresses
- Circuits with inductance may generate a voltage ($L di/dt$) above the rated voltage of the PPTC device.

Disclaimer Notice - Information furnished is believed to be accurate and reliable. However, users should independently evaluate the suitability of and test each product selected for their own applications. Littelfuse products are not designed for, and may not be used in, all applications. Read complete Disclaimer Notice at www.littelfuse.com/disclaimer-electronics.

1812L Series

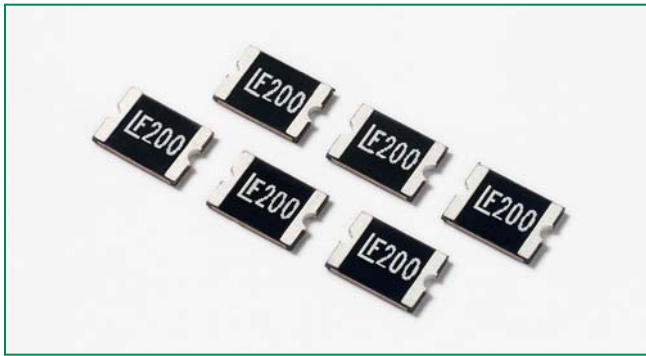

Description

The 1812L Series PTC provides surface mount overcurrent protection for applications where resettable protection is desired.



Features

- RoHS compliant, lead-free and halogen-free
- Fast response
- Compact design
- Low resistance
- Low-profile
- Compatible with high temperature solders



Applications

- Plug and play protection for motherboards and peripherals
- USB peripherals
- PCI cards
- Game console port protection

Agency Approvals

AGENCY	AGENCY FILE NUMBER
	E183209
	R50119118

Electrical Characteristics

Part Number	Marking	I _{hold} (A)	I _{trip} (A)	V _{max} (Vdc)	I _{max} (A)	P _d typ. (W)	Max. Time To Trip		Resistance		Agency Approvals	
							Current (A)	Time (Sec.)	R _{min} (Ω)	R _{1max} (Ω)		
1812L010	LF010	0.10	0.30	30	100	0.8	0.50	1.50	1.600	15.000	X	X
1812L010/60	LF010-60	0.10	0.30	60	10	0.8	0.50	1.50	1.600	15.000	X	X
1812L014	LF014	0.14	0.34	60	10	0.8	1.50	0.15	1.500	6.000	X	X
1812L020	LF020	0.20	0.40	30	100	0.8	8.00	0.02	0.800	5.000	X	X
1812L020/60	LF020-60	0.20	0.40	60	40	0.8	1.00	2.00	1.400	4.400	X	X
1812L035/30	LF035-30	0.35	0.75	30	40	0.8	8.00	0.15	0.400	1.700	X	X
1812L035/60	LF035-60	0.35	0.70	60	10	1.00	8.00	0.15	0.400	1.700	X	X
1812L050 ¹	LF050	0.50	1.00	15	100	0.8	8.00	0.15	0.150	1.000	X	X
1812L050/30	LF050-30	0.50	1.00	30	100	0.8	8.00	0.15	0.150	1.000	X	X
1812L050/60	LF050-60	0.50	1.00	60	10	1.50	8.00	0.15	0.150	1.000	X	X
1812L075 ¹	LF075	0.75	1.50	13.2	100	0.8	8.00	0.20	0.100	0.450	X	X
1812L075/24 ²	LF075-24	0.75	1.50	24	100	0.8	8.00	0.20	0.110	0.290	X	X
1812L075/33	LF075-33	0.75	1.50	33	20	0.8	8.00	0.20	0.110	0.400	X	X
1812L110 ¹	LF110	1.10	2.20	8	100	0.8	8.00	0.30	0.040	0.210	X	X
1812L110/16	LF110-16	1.10	1.95	16	100	0.8	8.00	0.30	0.060	0.180	X	X
1812L110/24	LF110-24	1.10	1.95	24	20	0.8	8.00	0.50	0.060	0.200	X	X
1812L110/33	LF110-33	1.10	1.95	33	20	0.8	8.00	0.50	0.060	0.200	X	X
1812L125/6	LF125-6	1.25	2.50	6	100	0.8	8.00	0.40	0.050	0.140	X	X
1812L125/16	LF125	1.25	2.50	16	100	0.8	8.00	0.40	0.050	0.140	X	X
1812L150 ¹	LF150	1.50	3.00	8	100	0.8	8.00	0.30	0.040	0.110	X	X
1812L150/12	LF150-12	1.50	3.00	12	100	0.8	8.00	0.50	0.040	0.110	X	X
1812L150/24 ²	LF150-24	1.50	3.00	24	20	0.8	8.00	1.50	0.040	0.120	X	X
1812L160 ¹	LF160	1.60	2.80	8	100	0.8	8.00	1.00	0.030	0.100	X	X
1812L160/12	LF160-12	1.60	2.80	12	100	0.8	8.00	1.00	0.030	0.100	X	X
1812L200TH ¹	LF200	2.00	3.50	8	100	0.8	8.00	2.00	0.020	0.070	X	X

continues on next page.

I_{hold} = Hold current: maximum current device will pass without tripping in 20°C still air.

I_{trip} = Trip current: minimum current at which the device will trip in 20°C still air.

V_{max} = Maximum voltage device can withstand without damage at rated current (I_{max})

I_{max} = Maximum fault current device can withstand without damage at rated voltage (V_{max})

P_d = Power dissipated from device when in the tripped state at 20°C still air.

R_{min} = Minimum resistance of device in initial (un-soldered) state.

R_{typ} = Typical resistance of device in initial (un-soldered) state.



R_{1max} = Maximum resistance of device at 20°C measured one hour after tripping or reflow soldering of 260°C for 20 sec.

Caution: Operation beyond the specified rating may result in damage and possible arcing and flame.

¹ Some older references to these devices may include “-C” in the Part Number. The “-C” should be omitted when placing new orders for the device.

² Part Number with note 2 tested and complied with AEC Q200.

Electrical Characteristics

Part Number	Marking	I _{hold} (A)	I _{trip} (A)	V _{max} (Vdc)	I _{max} (A)	P _d typ. (W)	Max. Time To Trip		Resistance		Agency Approvals	
							Current (A)	Time (Sec.)	R _{min} (Ω)	R _{1max} (Ω)		
1812L200/12	LF200-12	2.00	3.50	12	100	1.0	8.00	2.00	0.020	0.070	X	X
1812L200/16	LF200-16	2.00	3.50	16	100	1.0	8.00	2.00	0.020	0.070	X	X
1812L260TH ¹	LF260	2.60	5.20	8	100	0.8	8.00	2.50	0.015	0.047	X	X
1812L260/12	LF260-12	2.60	5.00	12	100	0.8	8.00	5.00	0.015	0.055	X	X
1812L260/16	LF260-16	2.60	5.00	16	100	1.2	8.00	5.00	0.015	0.050	X	X
1812L300	LF300	3.00	5.00	6	100	0.8	8.00	4.00	0.012	0.040	X	X

I_{hold} = Hold current: maximum current device will pass without tripping in 20°C still air.
 I_{trip} = Trip current: minimum current at which the device will trip in 20°C still air.
 V_{max} = Maximum voltage device can withstand without damage at rated current (I_{max})
 I_{max} = Maximum fault current device can withstand without damage at rated voltage (V_{max})
 P_d = Power dissipated from device when in the tripped state at 20°C still air.

R_{min} = Minimum resistance of device in initial (un-soldered) state.
 R_{typ} = Typical resistance of device in initial (un-soldered) state.
 R_{1max} = Maximum resistance of device at 20°C measured one hour after tripping or reflow soldering of 260°C for 20 sec.

Caution: Operation beyond the specified rating may result in damage and possible arcing and flame.

- 1 Some older references to these devices may include “-C” in the Part Number. The “-C” should be omitted when placing new orders for the device.
- 2 Part Number with note 2 tested and complied with AEC Q200.

Temperature Derating

Part Number	Ambient Operation Temperature								
	-40°C	-20°C	0°C	20°C	40°C	50°C	60°C	70°C	85°C
	Hold Current (A)								
1812L010	0.16	0.14	0.12	0.10	0.08	0.07	0.06	0.05	0.03
1812L010/60	0.14	0.13	0.11	0.10	0.09	0.08	0.07	0.07	0.05
1812L014	0.23	0.19	0.17	0.14	0.12	0.10	0.09	0.08	0.06
1812L020	0.29	0.26	0.23	0.20	0.17	0.15	0.14	0.12	0.10
1812L020/60	0.29	0.26	0.23	0.20	0.17	0.15	0.14	0.12	0.10
1812L035/30	0.50	0.45	0.40	0.35	0.30	0.26	0.24	0.20	0.16
1812L035/60	0.52	0.46	0.40	0.35	0.30	0.26	0.24	0.19	0.15
1812L050	0.77	0.68	0.59	0.50	0.44	0.40	0.37	0.33	0.29
1812L050/30	0.77	0.68	0.59	0.50	0.44	0.40	0.37	0.33	0.29
1812L050/60	0.72	0.66	0.57	0.50	0.44	0.39	0.35	0.31	0.24
1812L075	1.15	1.01	0.88	0.75	0.65	0.60	0.55	0.49	0.43
1812L075/24	1.06	0.95	0.84	0.75	0.60	0.55	0.50	0.45	0.37
1812L075/33	1.10	1.00	0.88	0.75	0.66	0.60	0.56	0.47	0.36
1812L110	1.59	1.43	1.26	1.10	0.95	0.87	0.80	0.71	0.60
1812L110/16	1.58	1.43	1.27	1.10	0.95	0.85	0.77	0.71	0.58
1812L110/24	1.55	1.40	1.25	1.10	0.93	0.83	0.73	0.63	0.50
1812L110/33	1.55	1.40	1.25	1.10	0.93	0.83	0.73	0.63	0.50
1812L125/6	2.00	1.75	1.52	1.25	1.00	0.95	0.90	0.75	0.53
1812L125/16	2.00	1.75	1.52	1.25	1.00	0.95	0.90	0.75	0.53
1812L150	2.06	1.93	1.79	1.50	1.28	1.10	1.02	0.80	0.68
1812L150/12	2.04	1.88	1.68	1.50	1.25	1.10	1.00	0.80	0.60
1812L150/24	2.05	1.87	1.67	1.50	1.25	1.08	0.95	0.77	0.60
1812L160	2.20	2.06	1.91	1.60	1.36	1.17	1.09	0.85	0.72
1812L160/12	2.20	2.06	1.91	1.60	1.36	1.17	1.09	0.85	0.72
1812L200TH	2.60	2.44	2.22	2.00	1.78	1.67	1.50	1.45	1.29
1812L200/12	2.80	2.60	2.36	2.00	1.72	1.56	1.40	1.20	1.04
1812L200/16	2.80	2.60	2.36	2.00	1.72	1.56	1.40	1.20	1.04
1812L260TH	3.40	3.16	3.00	2.60	2.30	2.15	2.00	1.85	1.63
1812L260/12	3.40	3.16	3.00	2.60	2.30	2.15	2.00	1.85	1.63
1812L260/16	3.66	3.30	2.96	2.60	2.23	2.06	1.89	1.61	1.30
1812L300	4.13	3.75	3.30	3.00	2.61	2.43	2.25	2.00	1.78

Notes: The temperature derating data is only for reference, please contact Littelfuse technical support for detail temperature derating information.

Temperature Derating Curve

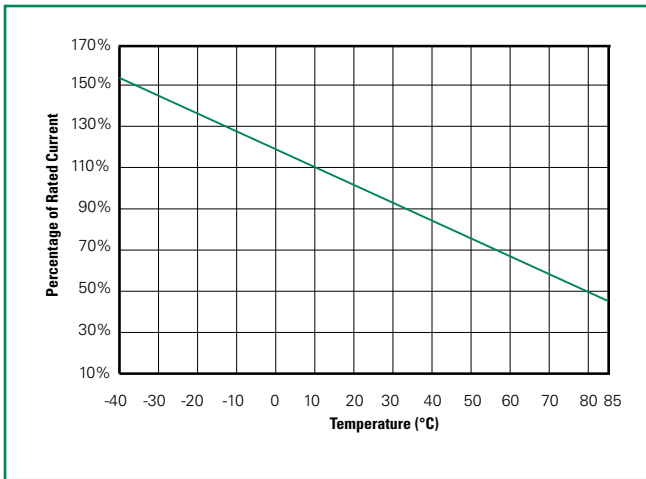

Note:
Typical Temperature derating curve, refer to table for derating data

Physical Specifications

Terminal Material	Solder-Plated Copper (Solder Material: Matte Tin (Sn))
Lead Solderability	Meets EIA Specification RS186-9E, ANSI/J-STD-002 Category 3.

Environmental Specifications

Operating/Storage Temp.	-40°C to +85°C
Max. Device Surface Temp. in Tripped State	125°C
Passive Aging	+85°C, 1000 hours -/+5% typical resistance change
Humidity Aging	+85°C, 85% R.H., 1000 hours -/+5% typical resistance change
Thermal Shock	MIL-STD-202, Method 107 +85°C/-40°C 20 times -30% typical resistance change
Solvent Resistance	MIL-STD-202, Method 215, No change
Vibration	MIL-STD-883, Method 2007, Condition A, No change
Moisture Level Sensitivity	Level 1, J-STD-020

Soldering Parameters

Profile Feature	Pb-Free Assembly	
Average Ramp-Up Rate ($T_{S(max)}$ to T_p)	3°C/second max	
Pre Heat:	Temperature Min ($T_{S(min)}$)	150°C
	Temperature Max ($T_{S(max)}$)	200°C
	Time (Min to Max) (t_s)	60 – 180 secs
Time Maintained Above:	Temperature (T_L)	217°C
	Temperature (t_L)	60 – 150 seconds
Peak / Classification Temperature (T_p)	260 ^{+0/-5} °C	
Time within 5°C of actual peak Temperature (t_p)	20 – 40 seconds	
Ramp-down Rate	6°C/second max	
Time 25°C to peak Temperature (T_p)	8 minutes Max.	

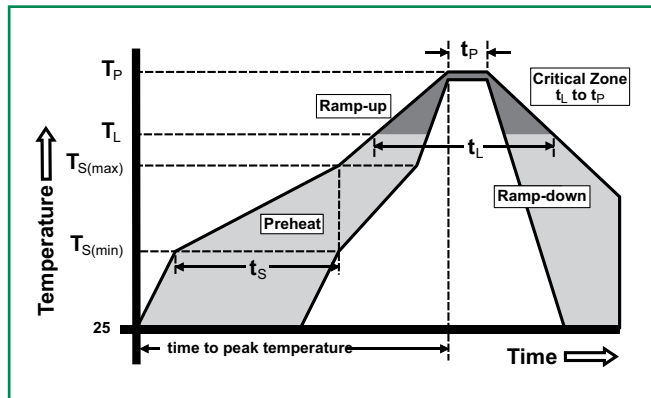

- All temperature refer to topside of the package, measured on the package body surface
- If reflow temperature exceeds the recommended profile, devices may not meet the performance requirements
- Recommended reflow methods: IR, vapor phase oven, hot air oven, N₂ environment for lead
- Recommended maximum paste thickness is 0.25mm (0.010inch)
- Devices can be cleaned using standard industry methods and solvents
- Devices can be reworked using the standard industry practices

Average Time Current Curves

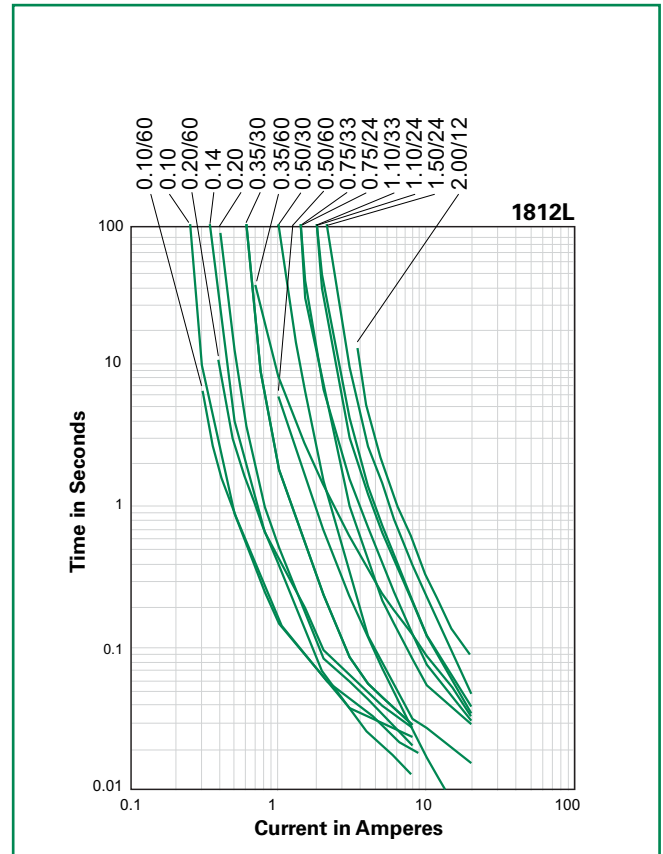
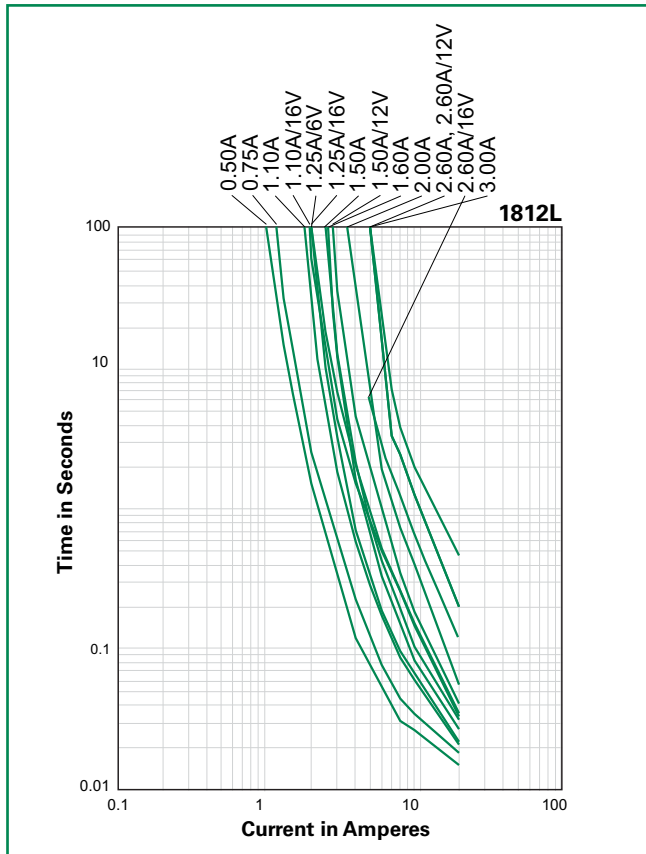

The average time current curves and Temperature Rerating curve performance is affected by a number of variables, and these curves provided as guidance only. Customer must verify the performance in their application.

Additional Information



Datasheet



Resources



Samples

Dimensions

MARKING CODE VARIES
WITH AMPERAGE AND VOLTAGE RATING
(See Electrical Characteristics Table)
SHOWN ARE:
- 1.1A/6V RATING (LEFT)
- 1.1A/33V RATING (RIGHT)

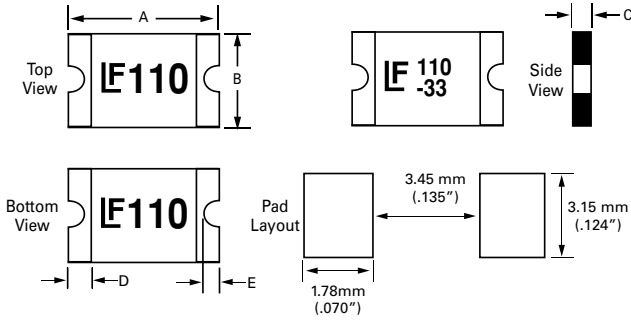

Part Number	A				B				C				D				E			
	Inches		mm		Inches		mm		Inches		mm		Inches		mm		Inches		mm	
	Min	Max	Min	Max	Min	Max	Min	Max	Min	Max	Min	Max	Min	Max	Min	Max	Min	Max	Min	Max
1812L010	0.17	0.19	4.37	4.73	0.12	0.13	3.07	3.41	0.03	0.05	0.75	1.25	0.01	0.05	0.3	1.2	0.01	0.03	0.15	0.65
1812L010/60	0.17	0.19	4.37	4.73	0.12	0.13	3.07	3.41	0.03	0.05	0.75	1.25	0.01	0.05	0.3	1.2	0.01	0.03	0.15	0.65
1812L014	0.17	0.19	4.37	4.73	0.12	0.13	3.07	3.41	0.03	0.08	0.75	1.95	0.01	0.05	0.3	1.2	0.01	0.03	0.15	0.65
1812L020	0.17	0.19	4.37	4.73	0.12	0.13	3.07	3.41	0.02	0.04	0.55	1.00	0.01	0.05	0.3	1.2	0.01	0.03	0.15	0.65
1812L020/60	0.17	0.19	4.37	4.73	0.12	0.13	3.07	3.41	0.03	0.05	0.75	1.25	0.01	0.05	0.3	1.20	0.01	0.03	0.15	0.65
1812L035/30	0.17	0.19	4.37	4.73	0.12	0.13	3.07	3.41	0.02	0.04	0.6	1.25	0.01	0.05	0.3	1.20	0.01	0.03	0.15	0.65
1812L035/60	0.17	0.19	4.37	4.73	0.12	0.13	3.07	3.41	0.05	0.07	1.2	1.8	0.01	0.05	0.3	1.2	0.01	0.03	0.15	0.65
1812L050	0.17	0.19	4.37	4.73	0.12	0.13	3.07	3.41	0.02	0.03	0.5	0.75	0.01	0.05	0.3	1.2	0.01	0.02	0.15	0.50
1812L050/30	0.17	0.19	4.37	4.73	0.12	0.13	3.07	3.41	0.02	0.04	0.5	1.00	0.01	0.05	0.3	1.2	0.01	0.03	0.15	0.65
1812L050/60	0.17	0.19	4.37	4.73	0.12	0.13	3.07	3.41	0.05	0.07	1.2	1.8	0.01	0.05	0.3	1.2	0.01	0.03	0.15	0.65
1812L075	0.17	0.19	4.37	4.73	0.12	0.13	3.07	3.41	0.02	0.03	0.5	0.75	0.01	0.05	0.3	1.2	0.01	0.02	0.15	0.50
1812L075/24	0.17	0.19	4.37	4.73	0.12	0.13	3.07	3.41	0.03	0.06	0.75	1.55	0.01	0.05	0.3	1.2	0.01	0.03	0.15	0.65
1812L075/33	0.17	0.19	4.37	4.73	0.12	0.13	3.07	3.41	0.03	0.06	0.75	1.55	0.01	0.05	0.3	1.2	0.01	0.03	0.15	0.65
1812L110	0.17	0.19	4.37	4.73	0.12	0.13	3.07	3.41	0.02	0.03	0.50	0.71	0.01	0.05	0.3	1.2	0.01	0.02	0.15	0.65
1812L110/24	0.17	0.19	4.37	4.73	0.12	0.13	3.07	3.41	0.02	0.04	0.50	1.07	0.01	0.05	0.3	1.2	0.01	0.03	0.15	0.65
1812L110/16	0.17	0.19	4.37	4.73	0.12	0.13	3.07	3.41	0.03	0.05	0.75	1.25	0.01	0.05	0.3	1.2	0.01	0.03	0.15	0.65
1812L110/33	0.17	0.19	4.37	4.73	0.12	0.13	3.07	3.41	0.05	0.08	1.20	2.00	0.01	0.05	0.3	1.2	0.01	0.03	0.15	0.65
1812L125/6	0.17	0.19	4.37	4.73	0.12	0.13	3.07	3.41	0.02	0.03	0.45	0.75	0.01	0.05	0.3	1.2	0.01	0.03	0.15	0.65
1812L125/16	0.17	0.19	4.37	4.73	0.12	0.13	3.07	3.41	0.03	0.05	0.75	1.25	0.01	0.05	0.3	1.2	0.01	0.02	0.15	0.65
1812L150	0.17	0.19	4.37	4.73	0.12	0.13	3.07	3.41	0.02	0.03	0.40	0.71	0.01	0.05	0.3	1.2	0.01	0.03	0.15	0.65
1812L150/12	0.17	0.19	4.37	4.73	0.12	0.13	3.07	3.41	0.03	0.05	0.75	1.25	0.01	0.05	0.3	1.2	0.01	0.03	0.15	0.65
1812L150/24	0.17	0.19	4.37	4.73	0.12	0.13	3.07	3.41	0.03	0.07	0.80	1.8	0.01	0.05	0.3	1.2	0.01	0.03	0.15	0.65
1812L160	0.17	0.19	4.37	4.73	0.12	0.13	3.07	3.41	0.02	0.03	0.40	0.75	0.01	0.05	0.3	1.2	0.01	0.03	0.15	0.65
1812L160/12	0.17	0.19	4.37	4.73	0.12	0.13	3.07	3.41	0.03	0.05	0.75	1.25	0.01	0.05	0.3	1.2	0.01	0.03	0.15	0.65
1812L200TH	0.17	0.19	4.37	4.73	0.12	0.13	3.07	3.41	0.008	0.024	0.20	0.6	0.01	0.05	0.3	1.2	0.01	0.02	0.15	0.65
1812L200/12	0.17	0.19	4.37	4.73	0.12	0.13	3.07	3.41	0.03	0.05	0.80	1.20	0.012	0.047	0.3	1.2	0.01	0.026	0.15	0.65
1812L200/16	0.17	0.19	4.37	4.73	0.12	0.13	3.07	3.41	0.03	0.05	0.80	1.20	0.012	0.047	0.3	1.2	0.01	0.026	0.15	0.65
1812L260TH	0.17	0.19	4.37	4.73	0.12	0.13	3.07	3.41	0.02	0.04	0.50	1.00	0.01	0.05	0.3	1.2	0.01	0.02	0.15	0.65
1812L260/12	0.17	0.19	4.37	4.73	0.12	0.13	3.07	3.41	0.03	0.05	0.80	1.34	0.01	0.05	0.3	1.2	0.01	0.03	0.15	0.65
1812L260/16	0.18	0.19	4.54	4.90	0.12	0.14	3.16	3.50	0.05	0.08	1.20	2.00	0.012	0.047	0.3	1.2	0.006	0.03	0.15	0.65
1812L300	0.17	0.19	4.37	4.73	0.12	0.13	3.07	3.41	0.02	0.06	0.50	1.50	0.01	0.05	0.3	1.2	0.01	0.03	0.15	0.65

Part Ordering Number System

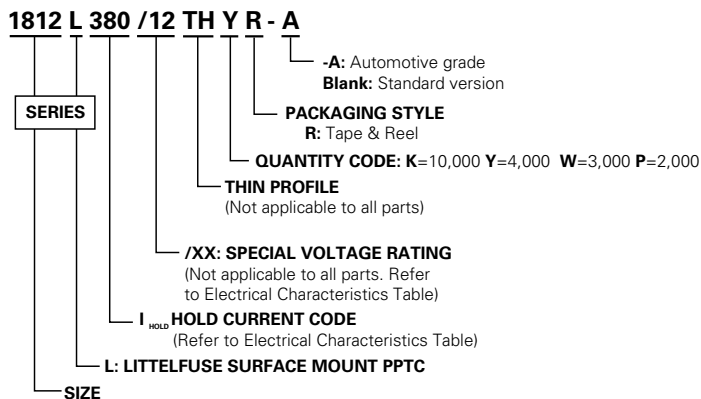

Packaging

Part Number	Ordering Number	Halogen Free	I_{hold} (A)	I_{hold} Code	Voltage Option	Packaging Option	Quantity	Quantity & Packaging Code
1812L010	1812L010DR	Yes	0.10	010		Tape and Reel	1500	DR
1812L010/60	1812L010/60DR	Yes	0.10	010	/60		1500	DR
1812L014	1812L014DR	Yes	0.14	014			1500	DR
1812L020	1812L020PR	Yes	0.20	020			2000	PR
1812L020/60	1812L020/60DR	Yes	0.20	020	/60		1500	DR
1812L035/30	1812L035/30DR	Yes	0.35	035	/30		1500	DR
1812L035/60	1812L035/60	Yes	0.35	035	/60		1000	MR
1812L050	1812L050PR	Yes	0.50	050			2000	PR
1812L050/30	1812L050/30PR	Yes	0.50	050	/30		2000	PR
1812L050/60	1812L050/60	Yes	0.50	050	/60		1000	MR
1812L075	1812L075PR	Yes	0.75	075			2000	PR
1812L75/24	1812L075/24DR	Yes	0.75	075	/24		1500	DR
1812L75/33	1812L075/33DR	Yes	0.75	075	/33		1500	DR
1812L110	1812L110PR	Yes	1.10	110			2000	PR
1812L110/16	1812L110/16DR	Yes	1.10	110	/16		1500	DR
1812L110/24	1812L110/24DR	Yes	1.10	110	/24		1500	DR
1812L110/33	1812L110/33MR	Yes	1.10	110	/33		1000	MR
1812L125/6	1812L125/6PR	Yes	1.25	125	/6		2000	PR
1812L125/16	1812L125/16DR	Yes	1.25	125	/16		1500	DR
1812L150	1812L150ZR	Yes	1.50	150			2000	ZR
1812L150/12	1812L150/12DR	Yes	1.50	150	/12		1500	DR
1812L150/24	1812L150/24MR	Yes	1.50	150	/24		1000	MR
1812L160	1812L160PR	Yes	1.60	160			2000	PR
1812L160/12	1812L160/12DR	Yes	1.60	160	/12		1500	DR
1812L200TH	1812L200THPR	Yes	2.00	200			2000	PR
1812L200/12	1812L200/12DR	Yes	2.00	200	/12		1500	DR
1812L200/16	1812L200/16DR	Yes	2.00	200			1500	DR
1812L260TH	1812L260THDR	Yes	2.60	260			1500	DR
1812L260/12	1812L260/12MR	Yes	2.60	260	/12		1000	MR
1812L260/16	1812L260/16MR	Yes	2.60	260			1000	MR
1812L300	1812L300MR	Yes	3.00	300			1000	MR

WARNING

- Users shall independently assess the suitability of these devices for each of their applications
- Operation of these devices beyond the stated maximum ratings could result in damage to the devices and lead to electrical arcing and/or fire
- These devices are intended to protect against the effects of temporary over-current or over-temperature conditions and are not intended to perform as protective devices where such conditions are expected to be repetitive or prolonged in duration
- Exposure to silicon-based oils, solvents, electrolytes, acids, and similar materials can adversely affect the performance of these PPTC devices
- These devices undergo thermal expansion under fault conditions, and thus shall be provided with adequate space and be protected against mechanical stresses
- Circuits with inductance may generate a voltage (L di/dt) above the rated voltage of the PPTC device.

Tape and Reel Specifications

TAPE SPECIFICATIONS: EIA-481-1 (mm)

	1812L020 1812L035/30 1812L050 1812L075 1812L110 1812L125/6 1812L150 1812L160 1812L200	1812L010 1812L010/60 1812L014 1812L020/60 1812L050/30 1812L075/24 1812L075/33 1812L110/16 1812L110/24 1812L125/16 1812L150/12 1812L160/12 1812L200/12 1812L200/16 1812L260	1812L035/60 1812L050/60 1812L110/33 1812L150/24 1812L260/12 1812L260/16 1812L300
W	12.00 ± 0.30	12.00 ± 0.30	12.00 ± 0.30
F	5.50 ± 0.05	5.50 ± 0.05	5.50 ± 0.05
E₁	1.75 ± 0.10	1.75 ± 0.10	1.75 ± 0.10
D₀	1.55 ± 0.10	1.55±/0.05	1.55 ± 0.05
D₁	1.55 (min)	1.50±/0.10	1.50 (MIN)
P₀	4.00 ± 0.10	4.00 ± 0.10	4.00 ± 0.08
P₁	8.00 ± 0.10	8.00 ± 0.10	8.00 ± 0.10
P₂	2.00 ± 0.05	2.00 ± 0.05	2.00 ± 0.05
A₀	3.58 ± 0.10	3.50 ± 0.10	3.58 ± 0.10
B₀	4.93 ± 0.10	4.85± 0.10	4.93 ± 0.10
T	0.25 ± 0.10	0.25 ± 0.10	0.25 ± 0.10
K₀	0.87± 0.06	1.25 ± 0.10	2.10 ± 0.10
Leader min.	390	390	390
Trailer min.	160	160	160

**REEL DIMENSIONS:
EIA-481-1 (mm)**

C	Ø178 ± 1.0
D	Ø60.2 ± 0.5
H	16.0 ± 0.5
W	13.2 ± 1.5

Tape and Reel Diagram

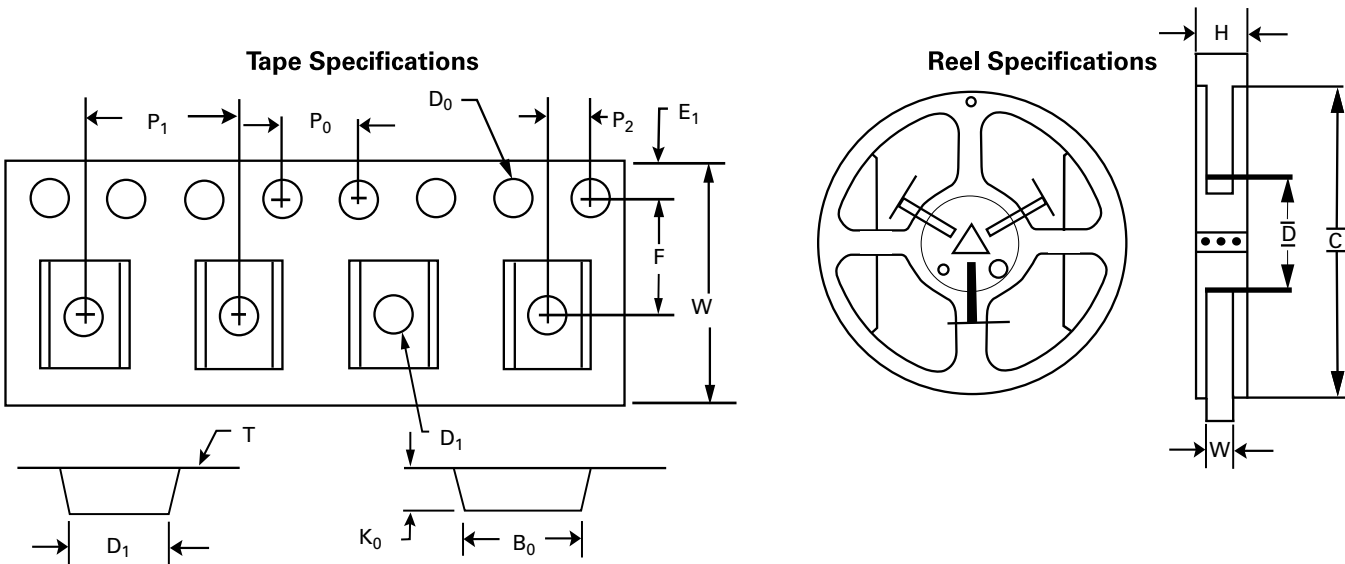

Disclaimer Notice - Information furnished is believed to be accurate and reliable. However, users should independently evaluate the suitability of and test each product selected for their own applications. Littelfuse products are not designed for, and may not be used in, all applications. Read complete Disclaimer Notice at www.littelfuse.com/disclaimer-electronics.

2016L Series



Description

The 2016L Series PTC provides surface mount overcurrent protection for low voltage ($\leq 60V$) applications where resettable protection is desired.

Features

- RoHS compliant, lead-free and halogen-free
- High voltage
- Fast response to fault currents
- Low-profile

Applications

- IEEE 1394 port protection
- Low voltage telecom equipment protection
- Powered ethernet port protection (IEEE 802.3 af)
- Automotive electronic control module protection

Agency Approvals

AGENCY	AGENCY FILE NUMBER
	E183209
	R50119118

Electrical Characteristics

Part Number	Marking	I_{hold} (A)	I_{trip} (A)	V_{max} (Vdc)	I_{max} (A)	P_d typ. (W)	Maximum Time To Trip		Resistance		Agency Approvals	
							Current (A)	Time (Sec.)	R_{min} (Ω)	R_{1max} (Ω)		
2016L030	LF030	0.30	0.60	60	20	1.40	1.5	3.0	0.500	2.300	X	X
2016L050	LF050	0.55	1.10	60	20	1.40	2.5	5.0	0.200	1.000	X	X
2016L075/60	LF075	0.75	1.50	60	20	1.40	8.0	0.5	0.130	0.900	X	X
2016L100	LF100	1.10	2.20	15	40	1.40	8.0	0.5	0.100	0.400	X	X
2016L100/33	LF100-33	1.10	2.20	33	40	1.40	8.0	0.5	0.100	0.400	X	X
2016L150	LF150	1.50	3.00	15	40	1.40	8.0	1.0	0.070	0.180	X	X
2016L150/33	LF150-33	1.50	3.00	33	40	2.0	8.00	1.00	0.070	0.180	X	X
2016L200	LF200	2.00	4.20	6	40	1.40	8.0	3.0	0.048	0.100	X	X
2016L260/24	LF260-24	2.60	5.00	24	40	1.6	8.00	5.00	0.025	0.075	X	X
2016L300/16	LF0300	3.00	5.00	16	40	1.6	8.00	10.00	0.015	0.048	X	X
2016L500	LF500	5.00	10.00	6	100	2.0	25.00	2.00	0.005	0.025	X	X

I_{hold} = Hold current: maximum current device will pass without tripping in 20°C still air.
 I_{trip} = Trip current: minimum current at which the device will trip in 20°C still air.
 V_{max} = Maximum voltage device can withstand without damage at rated current (I_{max})
 I_{max} = Maximum fault current device can withstand without damage at rated voltage (V_{max})
 P_d = Power dissipated from device when in the tripped state at 20°C still air.
 R_{min} = Minimum resistance of device in initial (un-soldered) state.
 R_{typ} = Typical resistance of device in initial (un-soldered) state.
 R_{1max} = Maximum resistance of device at 20°C measured one hour after tripping or reflow soldering of 260°C for 20 sec.

Caution: Operation beyond the specified rating may result in damage and possible arcing and flame.

* Agency Approval is Pending

WARNING

- Users shall independently assess the suitability of these devices for each of their applications
- Operation of these devices beyond the stated maximum ratings could result in damage to the devices and lead to electrical arcing and/or fire
- These devices are intended to protect against the effects of temporary over-current or over-temperature conditions and are not intended to perform as protective devices where such conditions are expected to be repetitive or prolonged in duration
- Exposure to silicon-based oils, solvents, electrolytes, acids, and similar materials can adversely affect the performance of these PPTC devices
- These devices undergo thermal expansion under fault conditions, and thus shall be provided with adequate space and be protected against mechanical stresses
- Circuits with inductance may generate a voltage ($L di/dt$) above the rated voltage of the PPTC device.

Temperature Derating

Part Number	Ambient Operation Temperature								
	-40°C	-20°C	0°C	20°C	40°C	50°C	60°C	70°C	85°C
2016L030	0.45	0.40	0.35	0.30	0.25	0.23	0.20	0.18	0.14
2016L050	0.93	0.80	0.65	0.50	0.42	0.38	0.33	0.30	0.23
2016L075/60	1.21	1.06	0.91	0.75	0.61	0.54	0.45	0.38	0.26
2016L100	1.66	1.47	1.29	1.10	0.91	0.83	0.73	0.64	0.50
2016L100/33	1.66	1.47	1.29	1.10	0.91	0.83	0.73	0.64	0.50
2016L150	2.26	2.00	1.76	1.50	1.24	1.13	1.00	0.87	0.68
2016L150/33	2.25	2.05	1.79	1.50	1.31	1.17	1.05	0.93	0.72
2016L200	2.80	2.50	2.19	2.00	1.84	1.74	1.50	1.34	1.14
2016L260/24	3.80	3.43	3.04	2.60	2.24	2.03	1.82	1.64	1.25
2016L300/16	4.32	3.93	3.57	3.00	2.58	2.40	2.22	1.89	1.68
2016L500	7.20	6.55	5.95	5.00	4.30	4.00	3.70	3.15	2.80

Average Time Current Curves

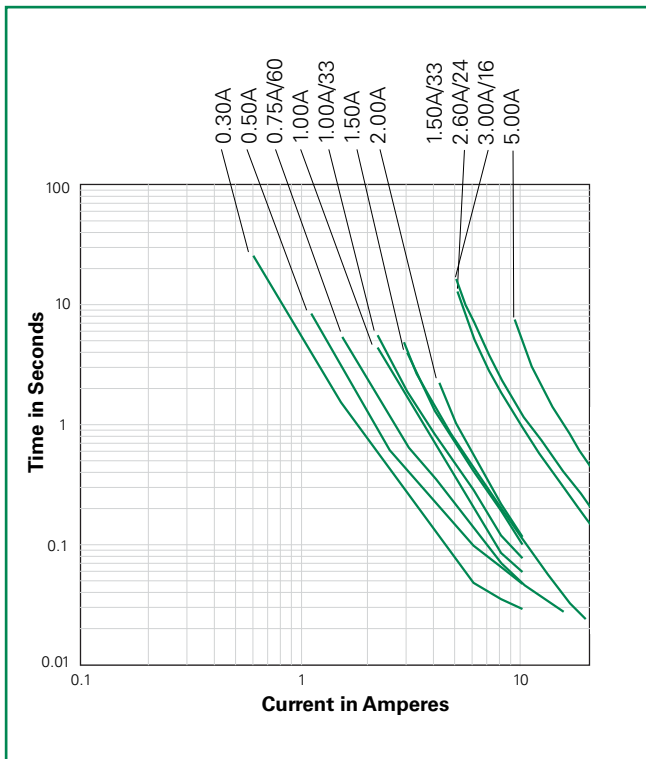

The average time current curves and Temperature Derating curve performance is affected by a number of variables, and these curves provided as guidance only. Customer must verify the performance in their application.

Temperature Derating Curve

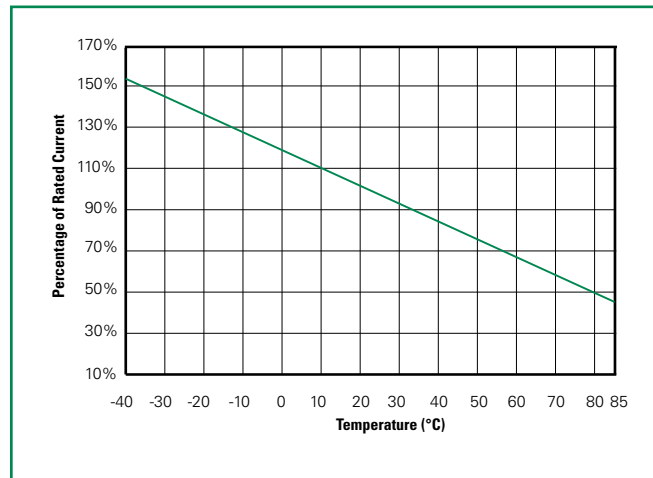

Note:
Typical Temperature derating curve, refer to table for derating data

Additional Information



Datasheet



Resources



Samples

Soldering Parameters

Profile Feature		Pb-Free Assembly
Average Ramp-Up Rate ($T_{S(max)}$ to T_P)		3°C/second max
Pre Heat:	Temperature Min ($T_{S(min)}$)	150°C
	Temperature Max ($T_{S(max)}$)	200°C
	Time (Min to Max) (t_s)	60 – 180 secs
Time Maintained Above:	Temperature (T_L)	217°C
	Temperature (t_L)	60 – 150 seconds
Peak / Classification Temperature (T_P)		260 ^{+0/-5} °C
Time within 5°C of actual peak Temperature (t_p)		20 – 40 seconds
Ramp-down Rate		6°C/second max
Time 25°C to peak Temperature (T_P)		8 minutes Max.

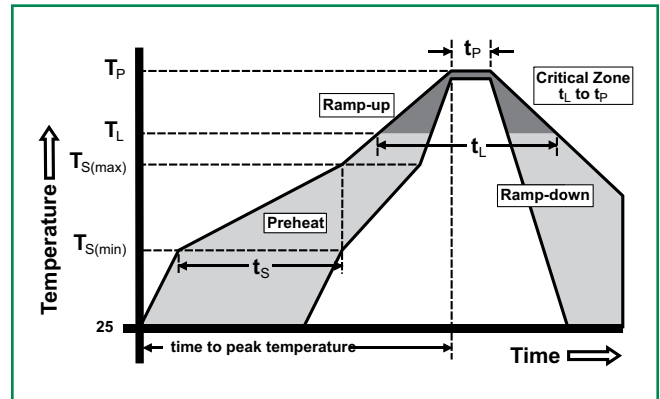

- All temperature refer to topside of the package, measured on the package body surface
- If reflow temperature exceeds the recommended profile, devices may not meet the performance requirements
- Recommended reflow methods: IR, vapor phase oven, hot air oven, N₂ environment for lead
- Recommended maximum paste thickness is 0.25mm (0.010inch)
- Devices can be cleaned using standard industry methods and solvents
- Devices can be reworked using the standard industry practices

Physical Specifications

Terminal Material	Solder-Plated Copper (Solder Material: Matte Tin(Sn))
Lead Solderability	Meets EIA Specification RS186-9E, ANSI/J-STD-002 Category 3.

Environmental Specifications

Operating/Storage Temperature	-40°C to +85°C
Maximum Device Surface Temperature in Tripped State	125°C
Passive Aging	+85°C, 1000 hours -/+5% typical resistance change
Humidity Aging	+85°C, 85%, R.H., 1000 hours -/+5% typical resistance change
Thermal Shock	MIL-STD-202, Method 107 +85°C/-40°C 20 times -30% typical resistance change
Solvent Resistance	MIL-STD-202, Method 215 No change
Vibration	MIL-STD-883, Method 2007, Condition A No change
Moisture Sensitivity Level	Level 1, J-STD-020

Dimensions (mm)

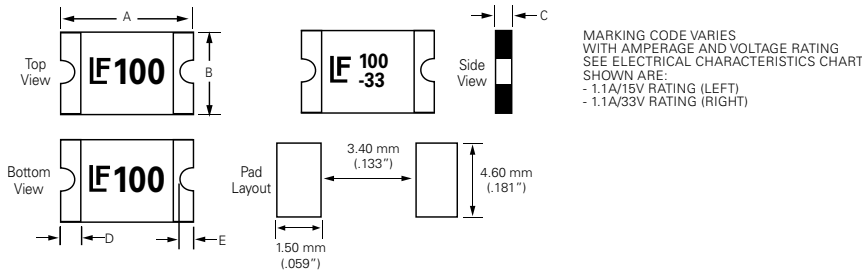

Part Number	A				B				C				D				E				
	Inches		mm		Inches		mm		Inches		mm		Inches		mm		Inches		mm		
	Min	Max	Min	Max	Min	Max	Min	Max	Min	Max	Min	Max	Min	Max	Min	Max	Min	Max	Min	Max	
2016L030									0.03	0.05	0.75	1.25									
2016L050									0.05	0.08	1.20	2.00									
2016L075/60									0.05	0.08	1.20	2.00									
2016L100								4.43	0.02	0.03	0.50	0.75									
2016L100/33									0.03	0.05	0.75	1.25									
2016L150	0.19	0.21	4.72	5.44	0.15	0.17	3.7		0.03	0.06	0.75	1.55	0.01	0.06	0.3	1.5	0.01	0.03	0.25	0.65	
2016L150/33								4.43	0.03	0.06	0.80	1.60									
2016L200								4.43	0.02	0.03	0.50	0.75									
2016L260/24																					
2016L300/16								4.43	0.03	0.06	0.80	1.60									
2016L500																					

Part Ordering Number System

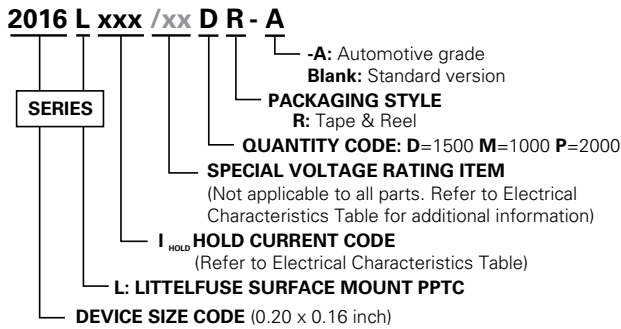

Packaging

Part Number	Ordering Number	Halogen Free	I _{hold} (A)	I _{hold} Code	Voltage Option	Packaging Option	Quantity	Quantity & Packaging Codes
2016L030	2016L030DR	Yes	0.30	030		Tape and Reel	1500	DR
2016L050	2016L050MR	Yes	0.55	050		Tape and Reel	1000	MR
2016L075/60	2016L075/60MR	Yes	0.75	075	/60	Tape and Reel	1000	MR
2016L100	2016L100PR	Yes	1.10	110		Tape and Reel	2000	PR
2016L100/33	2016L100/33DR	Yes	1.10	110	/33	Tape and Reel	1500	DR
2016L150	2016L150DR	Yes	1.50	150		Tape and Reel	1500	DR
2016L150/33	2016L150/33DR	Yes	1.50	150	/33	Tape and Reel	1,500	DR
2016L200	2016L200PR	Yes	2.00	200		Tape and Reel	2000	PR
2016L260/24	2016L260/24DR	Yes	2.60	260	/24	Tape and Reel	1,500	DR
2016L300/16	2016L300/16MR	Yes	3.00	300	/16	Tape and Reel	1,000	MR
2016L500	2016L500DR	Yes	5.00	500	/6	Tape and Reel	1,500	DR

Tape and Reel Specifications

TAPE SPECIFICATIONS: EIA-481-1 (mm)			
	2016L100 2016L200	2016L030 2016L100/33 2016L150 2016L150/33 2016L260/24 2016L300/16 2016L500	2016L050 2016L075/60
W	12.0+/-0.30	12.0+/-0.30	12.0+/-0.30
F	5.50+/-0.05	5.50+/-0.05	5.50+/-0.05
E₁	1.75+/-0.10	1.75+/-0.10	1.75+/-0.10
D₀	1.55+/-0.05	1.55+/-0.05	1.55+/-0.05
D₁	1.50 (MIN)	1.50 (MIN)	1.50 (MIN)
P₀	4.0+/-0.10	4.0+/-0.10	4.0+/-0.10
P₁	8.0+/-0.10	8.0+/-0.10	8.0+/-0.10
P₂	2.0+/-0.05	2.0+/-0.05	2.0+/-0.05
A₀	4.40+/-0.10	4.48+/-0.10	4.45+/-0.10
B₀	5.50+/-0.10	5.40+/-0.10	5.48+/-0.10
T	0.25+/-0.10	0.25+/-0.10	0.25+/-0.10
K₀	0.80+/-0.10	1.36+/-0.10	1.86+/-0.10
Leader Min.	390	390	390
Trailer Min.	160	160	160

REEL DIMENSIONS: EIA-481-1 (mm)	
C	Ø178.0+/-1.0
D	Ø60.2+/-0.5
H	16.0+/-0.5
W	13.2+/-1.5

Tape and Reel Diagram

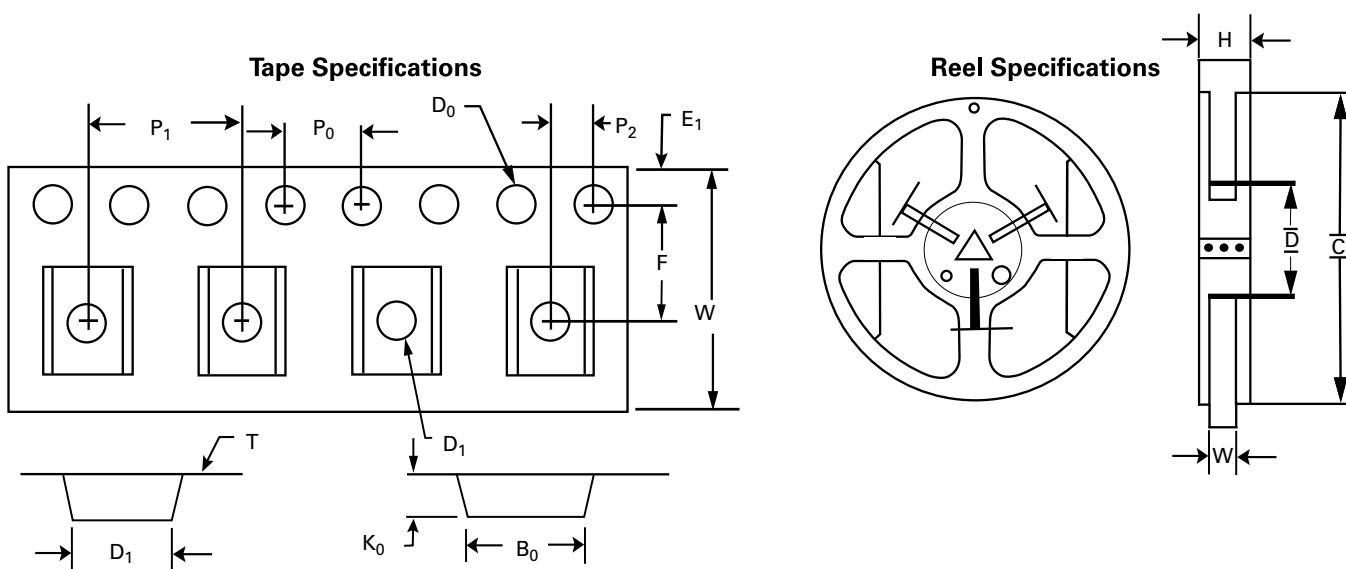

Disclaimer Notice - Information furnished is believed to be accurate and reliable. However, users should independently evaluate the suitability of and test each product selected for their own applications. Littelfuse products are not designed for, and may not be used in, all applications. Read complete Disclaimer Notice at www.littelfuse.com/disclaimer-electronics.

2920L Series



Description

The 2920L Series PTC provides surface mount overcurrent protection for medium voltage ($\leq 60V$) applications where resettable protection is desired.



Features

- RoHS compliant, lead-free and halogen-free
- Fast response to fault currents
- High voltage
- Low-profile



Applications

- IEEE 1394 port protection
- Powered ethernet port protection (IEEE 802.3 af)
- Automotive electronic control module protection
- Low voltage telecom equipment protection

Agency Approvals

AGENCY	AGENCY FILE NUMBER
	E183209
	R50119118

Electrical Characteristics

Part Number	Marking	I_{hold} (A)	I_{trip} (A)	V_{max} (Vdc)	I_{max} (A)	$P_{d,typ}$ (W)	Maximum Time To Trip		Resistance		Agency Approvals	
							Current (A)	Time (Sec.)	R_{min} (Ω)	R_{1max} (Ω)		
2920L030	LF030	0.30	0.60	60	10	1.50	1.50	3.00	1.200	4.800	X	X
2920L050	LF050	0.50	1.00	60	10	1.50	2.50	4.00	0.350	1.400	X	X
2920L075	LF075	0.75	1.50	30	40	1.50	8.00	0.30	0.350	1.000	X	X
2920L075/60	LF075-60	0.75	1.50	60	10	1.50	8.00	0.30	0.300	0.950	X	X
2920L100	LF100	1.10	2.20	33	40	1.50	8.00	0.50	0.120	0.410	X	X
2920L110/60	LF110	1.10	2.20	60	20	2.00	8.00	0.50	0.120	0.410	X	X
2920L125	LF125	1.25	2.50	15	40	1.50	8.00	2.00	0.070	0.250	X	X
2920L150	LF150	1.50	3.00	33	40	1.50	8.00	2.00	0.080	0.230	X	X
2920L185	LF185	1.85	3.70	33	40	1.50	8.00	2.50	0.050	0.150	X	X
2920L200	LF200	2.00	4.00	15	40	1.50	8.00	5.00	0.050	0.125	X	X
2920L200/24	LF200-24	2.00	4.00	24	40	1.50	8.00	5.00	0.050	0.125	X	X
2920L250	LF250	2.50	5.00	15	40	1.50	8.00	10.00	0.035	0.085	X	X
2920L260	LF260	2.60	5.00	6	40	1.50	8.00	10.00	0.025	0.075	X	X
2920L260/24	LF260-24	2.60	5.00	24	40	1.50	8.00	10.00	0.025	0.075	X	X
2920L300	LF300	3.00	5.00	6	40	1.50	8.00	20.00	0.015	0.048	X	X
2920L300/15	LF300-15	3.00	5.00	15	40	1.50	8.00	20.00	0.015	0.048	X	X
2920L330/24	LF330	3.3	5.50	24	40	2.0	8.00	5.00	0.015	0.055	X	X
2920L400/15	LF400	4.00	8.00	15	40	1.50	20.00	4.00	0.010	0.040	X	X
2920L500/16	LF500-16	5.00	10.00	16	40	2.0	20.00	5.00	0.005	0.025	X	X
2920L600/12	LF600	6.00	12.00	12	50	2.00	30.00	2.00	0.004	0.020	X	X
2920L700/12	LF700-12	7.00	14.00	12	50	2.00	35.00	2.00	0.003	0.018	X	X

I_{hold} = Hold current: maximum current device will pass without tripping in 20°C still air.

I_{trip} = Trip current: minimum current at which the device will trip in 20°C still air.

V_{max} = Maximum voltage device can withstand without damage at rated current (I_{max})

I_{max} = Maximum fault current device can withstand without damage at rated voltage (V_{max})

$P_{d,typ}$ = Power dissipated from device when in the tripped state at 20°C still air.

R_{min} = Minimum resistance of device in initial (un-soldered) state.

R_{typ} = Typical resistance of device in initial (un-soldered) state.

R_{1max} = Maximum resistance of device at 20°C measured one hour after tripping or reflow soldering of 260°C for 20 sec.

Caution: Operation beyond the specified rating may result in damage and possible arcing and flame.

Temperature Derating

Part Number	Ambient Operation Temperature								
	-40°C	-20°C	0°C	20°C	40°C	50°C	60°C	70°C	85°C
2920L030	0.45	0.40	0.35	0.30	0.25	0.23	0.20	0.17	0.14
2920L050	0.76	0.67	0.59	0.50	0.42	0.38	0.33	0.29	0.23
2920L075	1.13	1.01	0.88	0.75	0.62	0.56	0.50	0.44	0.34
2920L075/60	1.13	1.01	0.88	0.75	0.62	0.56	0.50	0.44	0.34
2920L100	1.66	1.47	1.29	1.10	0.91	0.83	0.73	0.64	0.50
2920L110/60	1.62	1.46	1.29	1.10	0.91	0.83	0.73	0.64	0.50
2920L125	1.89	1.68	1.46	1.25	1.04	0.94	0.83	0.73	0.56
2920L150	2.27	2.01	1.76	1.50	1.25	1.13	1.00	0.87	0.74
2920L185	2.80	2.47	2.17	1.85	1.54	1.39	1.22	1.07	0.85
2920L200	3.02	2.68	2.34	2.00	1.66	1.50	1.32	1.16	0.90
2920L200/24	3.14	2.77	2.42	2.00	1.73	1.56	1.38	1.20	0.98
2920L250	3.78	3.35	2.93	2.50	2.08	1.88	1.65	1.45	1.13
2920L260	3.64	3.25	2.91	2.60	2.26	2.08	1.95	1.74	1.48
2920L260/24	3.64	3.25	2.91	2.60	2.26	2.08	1.95	1.74	1.48
2920L300	4.53	4.02	3.51	3.00	2.52	2.26	1.99	1.75	1.34
2920L300/15	4.20	3.85	3.44	3.00	2.69	2.50	2.31	2.12	1.83
2920L330/24	4.70	4.20	3.80	3.30	2.90	2.60	2.30	1.90	1.60
2920L400/15	5.50	5.00	4.50	4.00	3.40	3.10	2.80	2.50	2.10
2920L500/16	6.85	6.25	5.65	5.00	4.25	3.88	3.50	2.80	2.25
2920L600/12	8.58	7.80	6.96	6.00	5.34	4.80	4.50	4.08	3.40
2920L700/12	10.01	9.10	8.19	7.00	6.09	5.60	5.18	4.62	3.99

Notes: The temperature derating data is only for reference, please contact Littelfuse technical support for detail temperature derating information.

Average Time Current Curves

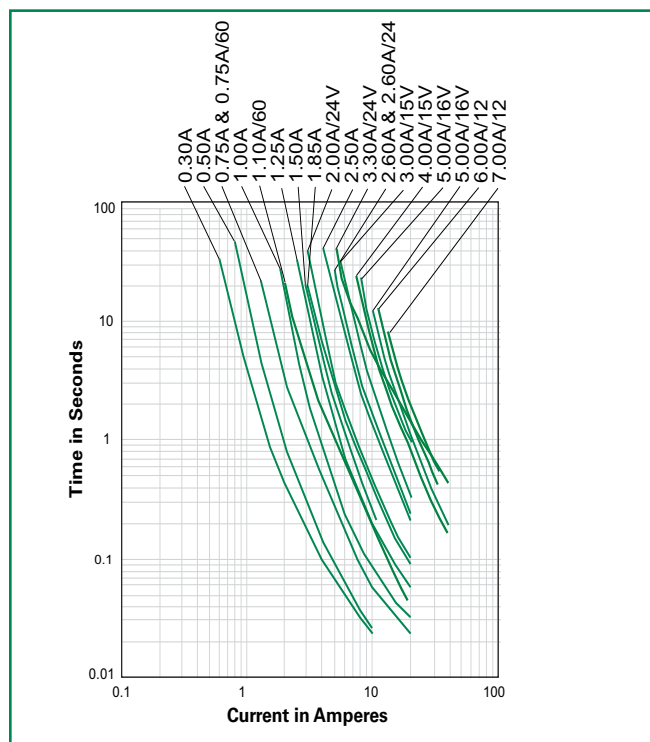

The average time current curves and Temperature Derating curve performance is affected by a number of variables, and these curves provided as guidance only. Customer must verify the performance in their application.

Temperature Derating Curve

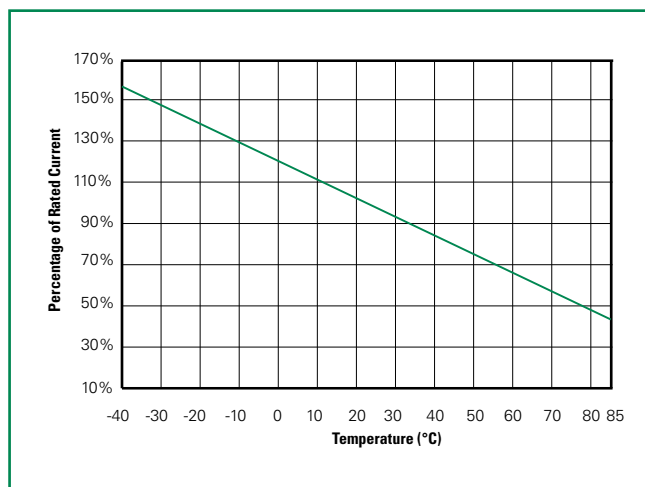

Note:
Typical Temperature derating curve, refer to table for derating data

Soldering Parameters

Profile Feature	Pb-Free Assembly	
Average Ramp-Up Rate ($T_{S(max)}$ to T_P)	3°C/second max	
Pre Heat:	Temperature Min ($T_{S(min)}$)	150°C
	Temperature Max ($T_{S(max)}$)	200°C
	Time (Min to Max) (t_s)	60 – 180 secs
Time Maintained Above:	Temperature (T_L)	217°C
	Temperature (t_L)	60 – 150 seconds
Peak / Classification Temperature (T_P)	260 ^{+0/-5} °C	
Time within 5°C of actual peak Temperature (t_p)	20 – 40 seconds	
Ramp-down Rate	6°C/second max	
Time 25°C to peak Temperature (T_P)	8 minutes Max.	

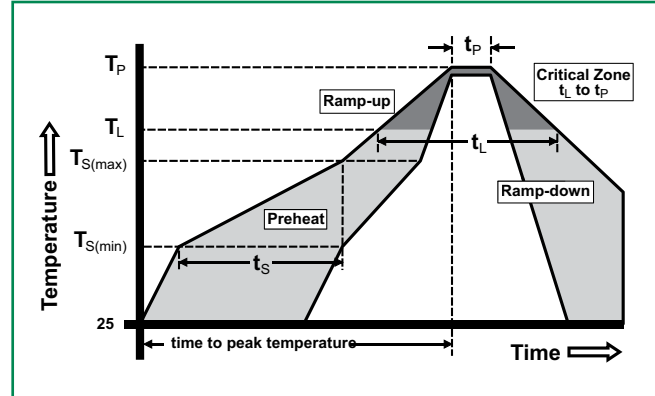

- All temperature refer to topside of the package, measured on the package body surface
- If reflow temperature exceeds the recommended profile, devices may not meet the performance requirements
- Recommended reflow methods: IR, vapor phase oven, hot air oven, N₂ environment for lead
- Recommended maximum paste thickness is 0.25mm (0.010inch)
- Devices can be cleaned using standard industry methods and solvents
- Devices can be reworked using the standard industry practices

Physical Specifications

Terminal Material	Solder-Plated Copper (Solder Material: Matte Tin(Sn))
Lead Solderability	Meets EIA Specification RS186-9E, ANSI/J-STD-002 Category 3.

Additional Information



Datasheet



Resources



Samples

Environmental Specifications

Operating/Storage Temperature	-40°C to +85°C
Maximum Device Surface Temperature in Tripped State	125°C
Passive Aging	+85°C, 1000 hours -/ +5% typical resistance change
Humidity Aging	+85°C, 85%, R.H., 1000 hours -/ +5% typical resistance change
Thermal Shock	MIL-STD-20 2, Method 107 +85°C/-40°C 20 times -30% typical resistance change
Solvent Resistance	MIL-STD-202, Method 215
Vibration	MIL-STD-883, Method 2007, Condition A
Moisture Sensitivity Level	Level 1, J-STD-020

Dimensions (mm)

MARKING CODE VARIES
 WITH AMPERAGE AND VOLTAGE RATING
 (SEE ELECTRICAL CHARACTERISTIC TABLE)
 SHOWN ARE:
 - 1.5A/33V RATING (LEFT)
 - 2.0A/24V RATING (RIGHT)

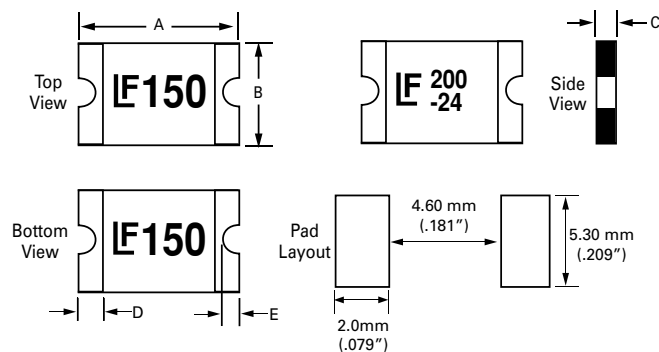

Part Number	A				B				C				D				E			
	Inches		mm		Inches		mm		Inches		mm		Inches		mm		Inches		mm	
	Min	Max	Min	Max	Min	Max	Min	Max	Min	Max	Min	Max	Min	Max	Min	Max	Min	Max	Min	Max
2920L030	0.26	0.31	6.73	7.98	0.19	0.21	4.8	5.44	0.03	0.05	0.75	1.25	0.01	0.1	0.3	2.5	0.01	0.08	0.25	2.0
2920L050	0.26	0.31	6.73	7.98	0.19	0.21	4.8	5.44	0.03	0.05	0.75	1.25	0.01	0.1	0.3	2.5	0.01	0.08	0.25	2.0
2920L075	0.26	0.31	6.73	7.98	0.19	0.21	4.8	5.44	0.03	0.05	0.75	1.25	0.01	0.1	0.3	2.5	0.01	0.08	0.25	2.0
2920L075/60	0.26	0.31	6.73	7.98	0.19	0.21	4.8	5.44	0.05	0.06	1.20	1.80	0.01	0.1	0.3	2.5	0.01	0.08	0.25	2.0
2920L100	0.26	0.31	6.73	7.98	0.19	0.21	4.8	5.44	0.02	0.04	0.55	1.00	0.01	0.1	0.3	2.5	0.01	0.08	0.25	2.0
2920L110/60	0.26	0.31	6.73	7.98	0.19	0.21	4.8	5.44	0.06	0.079	1.2	2.0	0.01	0.1	0.3	2.5	0.01	0.08	0.25	2.0
2920L125	0.26	0.31	6.73	7.98	0.19	0.21	4.8	5.44	0.02	0.04	0.55	1.00	0.01	0.1	0.3	2.5	0.01	0.08	0.25	2.0
2920L150	0.26	0.31	6.73	7.98	0.19	0.21	4.8	5.44	0.03	0.05	0.75	1.25	0.01	0.1	0.3	2.5	0.01	0.08	0.25	2.0
2920L185	0.26	0.31	6.73	7.98	0.19	0.21	4.8	5.44	0.03	0.05	0.75	1.25	0.01	0.1	0.3	2.5	0.01	0.08	0.25	2.0
2920L200	0.26	0.31	6.73	7.98	0.19	0.21	4.8	5.44	0.03	0.05	0.75	1.25	0.01	0.1	0.3	2.5	0.01	0.08	0.25	2.0
2920L200/24	0.26	0.31	6.73	7.98	0.19	0.21	4.8	5.44	0.03	0.05	0.75	1.25	0.01	0.1	0.3	2.5	0.01	0.08	0.25	2.0
2920L250	0.26	0.31	6.73	7.98	0.19	0.21	4.8	5.44	0.03	0.05	0.75	1.25	0.01	0.1	0.3	2.5	0.01	0.08	0.25	2.0
2920L260	0.26	0.31	6.73	7.98	0.19	0.21	4.8	5.44	0.02	0.04	0.55	1.00	0.01	0.1	0.3	2.5	0.01	0.08	0.25	2.0
2920L260/24	0.26	0.31	6.73	7.98	0.19	0.21	4.8	5.44	0.03	0.05	0.75	1.25	0.01	0.1	0.3	2.5	0.01	0.08	0.25	2.0
2920L300	0.26	0.31	6.73	7.98	0.19	0.21	4.8	5.44	0.03	0.05	0.75	1.25	0.01	0.1	0.3	2.5	0.01	0.08	0.25	2.0
2920L300/15	0.26	0.31	6.73	7.98	0.19	0.21	4.8	5.44	0.03	0.05	0.75	1.25	0.01	0.1	0.3	2.5	0.01	0.08	0.25	2.0
2920L330/24	0.26	0.31	6.73	7.98	0.19	0.21	4.8	5.44	0.06	0.079	1.2	2	0.01	0.1	0.3	2.5	0.01	0.08	0.25	2.0
2920L400/15	0.26	0.31	6.73	7.98	0.19	0.21	4.8	5.44	0.03	0.06	0.8	1.6	0.01	0.1	0.3	2.5	0.01	0.08	0.25	2.0
2920L500/16	0.26	0.31	6.73	7.98	0.19	0.21	4.80	5.44	0.03	0.06	0.8	1.6	0.01	0.1	0.3	2.5	0.01	0.08	0.25	2.0
2920L600/12	0.26	0.31	6.73	7.98	0.19	0.21	4.8	5.44	0.031	0.063	0.8	1.6	0.01	0.1	0.3	2.5	0.01	0.08	0.25	2.0
2920L700/12	0.26	0.31	6.73	7.98	0.19	0.21	4.8	5.44	0.031	0.063	0.8	1.6	0.01	0.1	0.3	2.5	0.01	0.08	0.25	2.0

Part Ordering Number System

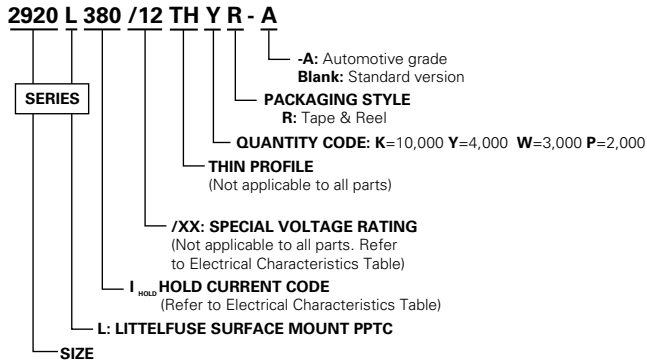

Packaging

Part Number	Ordering Number	Halogen Free	I_{hold} (A)	I_{hold} Code	Voltage Option	Packaging Option	Quantity	Quantity & Packaging Codes
2920L030	2920L030DR	Yes	0.30	030		Tape and Reel	1500	DR
2920L050	2920L050DR	Yes	0.50	050		Tape and Reel	1500	DR
2920L075	2920L075DR	Yes	0.75	075		Tape and Reel	1500	DR
2920L075/60	2920L075/60MR	Yes	0.75	075	/60	Tape and Reel	1000	MR
2920L100	2920L100PR	Yes	1.10	100		Tape and Reel	2000	PR
2920L110/60	2920L110/60MR	Yes	1.1	110	/60	Tape and Reel	1,000	MR
2920L125	2920L125PR	Yes	1.25	125		Tape and Reel	2000	PR
2920L150	2920L150DR	Yes	1.50	150		Tape and Reel	1500	DR
2920L185	2920L185DR	Yes	1.85	185		Tape and Reel	1500	DR
2920L200	2920L200DR	Yes	2.00	200		Tape and Reel	1500	DR
2920L200/24	2920L200/24DR	Yes	2.00	200	/24	Tape and Reel	1500	DR
2920L250	2920L250DR	Yes	2.50	250		Tape and Reel	1500	DR
2920L260/24	2920L260/24DR	Yes	2.60	260	/24	Tape and Reel	1500	DR
2920L260	2920L260PR	Yes	2.60	260		Tape and Reel	2000	PR
2920L300	2920L300DR	Yes	3.00	300		Tape and Reel	1500	DR
2920L300/15	2920L300/15DR	Yes	3.00	300	/15	Tape and Reel	1500	DR
2920L330/24	2920L330/24MR	Yes	3.3	330	/24	Tape and Reel	1,000	MR
2920L400/15	2920L400/15MR	Yes	4	400	/15	Tape and Reel	1,000	MR
2920L500/16	2920L500/16MR	Yes	5.00	500		Tape and Reel	1,000	MR
2920L600/12	2920L600/12MR	Yes	6.0	600	/12	Tape and Reel	1,000	MR
2920L700/12	2920L700/12MR	Yes	7.0	700	/12	Tape and Reel	1,000	MR

Tape and Reel Specifications

TAPE SPECIFICATIONS: EIA-481-1 (mm)			
	2920L030, 2920L050 2920L075, 2920L150 2920L185, 2920L200 2920L200/24 2920L250, 2920L300 2920L300/15	2920L100, 2920L125, 2920L260	2920L075/60 2920L110/60 2920L500/16 2920L330/24 2920L400/15 2920L600/12 2920L700/12
W	16.0+/-0.30	16.0+/-0.30	16.0+/-0.30
F	7.50+/-0.10	7.50+/-0.05	7.50+/-0.10
E₁	1.75+/-0.10	1.75+/-0.10	1.75+/-0.10
D₀	1.55+/-0.05	1.55+/-0.05	1.50+/-0.05
D₁	1.50+/-0.10	1.50+/-0.10	1.50 (min)
P₀	4.00+/-0.10	4.00+/-0.10	4.00+/-0.10
P₁	8.00+/-0.10	8.00+/-0.10	8.00+/-0.10
P₂	2.00+/-0.05	2.00+/-0.05	2.00+/-0.05
A₀	5.74+/-0.10	5.74+/-0.10	5.45+/-0.10
B₀	8.02+/-0.10	8.02+/-0.10	7.80+/-0.10
T	0.30+/-0.10	0.30+/-0.10	0.30+/-0.10
K₀	1.30+/-0.10	0.91+/-0.10	2.00+/-0.10
Leader min.	390	390	390
Trailer min.	160	160	160

REEL DIMENSIONS: EIA-481-1 (mm)	
C	Ø180.0+/-3.0
D	Ø60+/-0.5
H	19.5+/-1.0
W	17+/-0.2

Tape and Reel Diagram

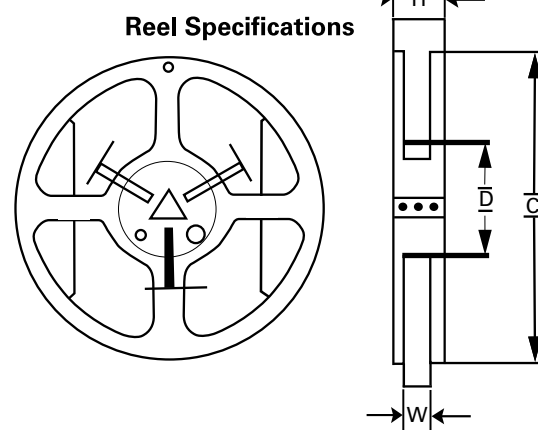
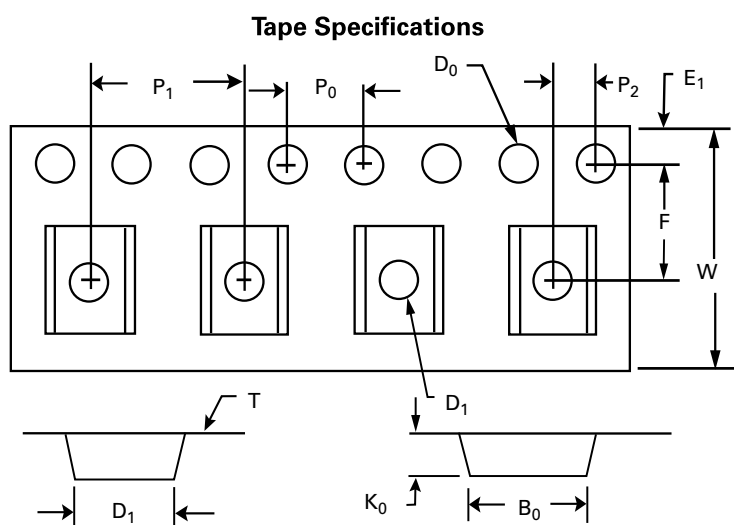

WARNING

- Users shall independently assess the suitability of these devices for each of their applications
- Operation of these devices beyond the stated maximum ratings could result in damage to the devices and lead to electrical arcing and/or fire
- These devices are intended to protect against the effects of temporary over-current or over-temperature conditions and are not intended to perform as protective devices where such conditions are expected to be repetitive or prolonged in duration
- Exposure to silicon-based oils, solvents, electrolytes, acids, and similar materials can adversely affect the performance of these PPTC devices
- These devices undergo thermal expansion under fault conditions, and thus shall be provided with adequate space and be protected against mechanical stresses
- Circuits with inductance may generate a voltage (L di/dt) above the rated voltage of the PPTC device.

Disclaimer Notice - Information furnished is believed to be accurate and reliable. However, users should independently evaluate the suitability of and test each product selected for their own applications. Littelfuse products are not designed for, and may not be used in, all applications. Read complete Disclaimer Notice at www.littelfuse.com/disclaimer-electronics.

250S Series



Description

The 250S High Voltage Radial device is a Polymer-based PTC suitable to protect telephony equipment against lightning and power cross strikes. The 250S Series is fully compatible with telecommunications standards, and is offered in horizontal and new vertical surface mount package.



Features

- RoHS Compliant, Directive 2002/95/EC
- Lead-Free & Halogen-Free
- Low resistance
- Compatible with telecom standards
- Helps meet ITU K.20, K.21/Telcordia standards
- Excellent solder joint inspectability
- High voltage

Applications

- Customer Premises Equipment (CPE)
- Central Office (CO)/telecom centers
- LAN/WAN equipment
- Access equipment

Agency Approvals

AGENCY	AGENCY FILE NUMBER
	E183209
	R50120008

Additional Information



Datashheet



Resources



Samples

Electrical Characteristics

Part Number	Device Mounting Layout	I _{hold} (A)	I _{trip} (A)	V _{max} (V _{int} /V _{op})	I _{max} (A)	P _d typ. (W)	Time to Trip at 1A		Resistance			Agency Approvals
							Typical (Sec.)	Maximum (Sec.)	R _{min} (Ω)	R _{max} (Ω)	R _{1max} (Ω)	
250S130	Horizontal	0.13	0.26	250/60	3	1.2	0.9	4.0	4	13	20	–
250S130-RA		0.13	0.26	250/60	3	1.2	1.4	4.0	6.5	10	15	–
250S130-RB		0.13	0.26	250/60	3	1.2	0.7	4.0	9	13	20	–
250S130-RC		0.13	0.26	250/60	3	1.2	1.1	4.0	7	11	17	–
250S130V	Vertical	0.13	0.26	250/60	3	1.2	2.0	4.0	4	13	20	–

I_{hold} = Hold current: maximum current device will pass without tripping in 20°C still air.

I_{trip} = Trip current: minimum current at which the device will trip in 20°C still air.

V_{int} = Maximum voltage the device can withstand without damage at rated current (I_{max})

V_{op} = The device regular operation voltage

I_{max} = Maximum fault current device can withstand without damage at rated voltage (V_{max})

P_d = Power dissipated from device when in the tripped state at 20°C still air.

R_{min} = Minimum resistance of device in initial (un-soldered) state.

R_{max} = Maximum resistance of device in initial (un-soldered) state.

R_{1max} = Maximum resistance of device at 20°C measured one hour after tripping.

Caution: Operation beyond the specified rating may result in damage and possible arcing and flame.

WARNING

- Users shall independently assess the suitability of these devices for each of their applications
- Operation of these devices beyond the stated maximum ratings could result in damage to the devices and lead to electrical arcing and/or fire
- These devices are intended to protect against the effects of temporary over-current or over-temperature conditions and are not intended to perform as protective devices where such conditions are expected to be repetitive or prolonged in duration

- Exposure to silicon-based oils, solvents, electrolytes, acids, and similar materials can adversely affect the performance of these PPTC devices
- These devices undergo thermal expansion under fault conditions, and thus shall be provided with adequate space and be protected against mechanical stresses
- Circuits with inductance may generate a voltage (L di/dt) above the rated voltage of the PPTC device.

Temperature Derating

Part Number	Ambient Operation Temperature								
	-40°C	-20°C	0°C	20°C	40°C	50°C	60°C	70°C	85°C
250S130	0.21	0.19	0.17	0.13	0.11	0.10	0.09	0.07	0.05

Average Time Current Curves

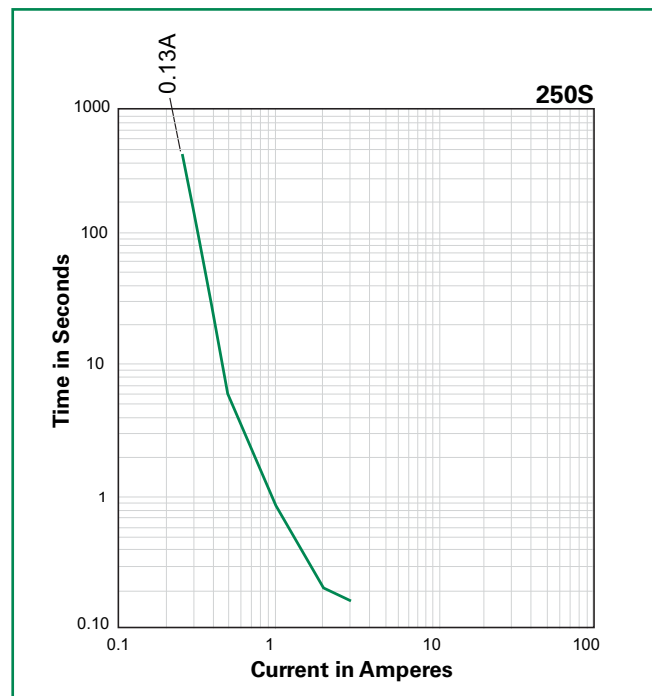

The average time current curves and Temperature Derating curve performance is affected by a number of variables, and these curves provided as guidance only. Customer must verify the performance in their application.

Temperature Derating Curve

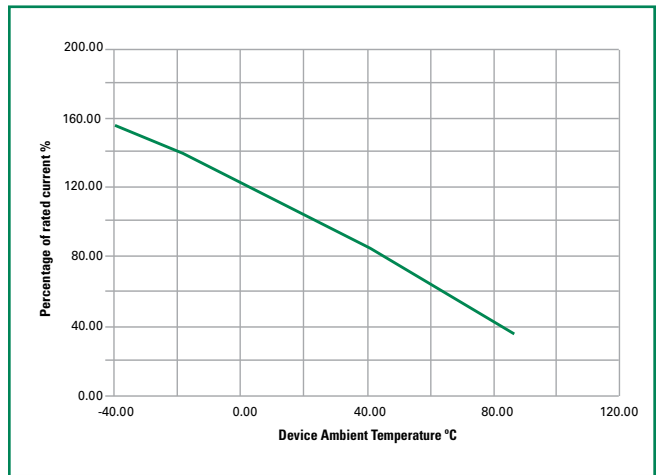

Agency Specification Selection Guide For Telecom and Networking Applications

Product	Lightning	Power Cross
250S130 250S130V 250S130-RA 250S130-RB 250S130-RC	ITU K.20/21/45 – 1.5kV 10/700µs	ITU K.20/21/45 – 230Vac, 10Ω

Protection Application Guide

Region/ Specification	Application	Device Selection
South America/ Asia/Europe ITU K.45	Access network equipment Remote terminal Repeaters WAN equipment Cross –connect	250S130 250S130V 250S130-RA 250S130-RB 250S130-RC
South America/ Asia/Europe ITU K.21	Customer and IT equipment Analog modems ADSL, xDSL Phone sets, PBX systems Internet appliances POS terminals	250S130 250S130V 250S130-RA 250S130-RB 250S130-RC
South America/ Asia/Europe ITU K.20	Central Office POTS/ISDN linecards T1/E1/J1 linecards ADSL/VDSL splitters CSU/DSU	250S130 250S130V 250S130-RA 250S130-RB 250S130-RC

Soldering Parameters

Profile Feature		Pb-Free Assembly
Average Ramp-Up Rate ($T_{S(max)}$ to T_P)		3°C/second max
Pre Heat:	Temperature Min ($T_{S(min)}$)	150°C
	Temperature Max ($T_{S(max)}$)	200°C
	Time (Min to Max) (t_s)	60 – 180 secs
Time Maintained Above:	Temperature (T_L)	217°C
	Temperature (t_L)	60 – 150 seconds
Peak / Classification Temperature (T_P)		260 ^{+0/-5} °C
Time within 5°C of actual peak Temperature (t_p)		20 – 40 seconds
Ramp-down Rate		6°C/second max
Time 25°C to peak Temperature (T_P)		8 minutes Max.

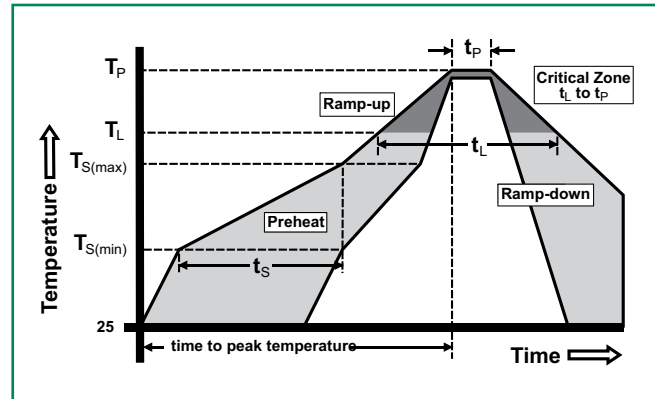

- All temperature refer to topside of the package, measured on the package body surface
- If reflow temperature exceeds the recommended profile, devices may not meet the performance requirements
- Recommended reflow methods: IR, vapor phase oven, hot air oven, N_2 environment for lead
- Recommended maximum paste thickness is 0.25mm (0.010inch)
- Devices can be cleaned using standard industry methods and solvents
- Devices can be reworked using the standard industry practices

Physical Specifications

Terminal Material	Solder-Plated Copper (Solder Material: Matte Tin(Sn))
Lead Solderability	Meets EIA Specification RS186-9E, ANSI/J-STD-002 Category 3.

Environmental Specifications

Operating/Storage Temperature	-40°C to +85°C
Maximum Device Surface Temperature in Tripped State	125°C
Passive Aging	+85°C, 1000 hours
Humidity Aging	+85°C, 85%, R.H., 1000 hours
Thermal Shock	MIL-STD-202, Method 107 +125°C to -55°C 10 times
Solvent Resistance	MIL-STD-202, Method 215
Moisture Sensitivity Level	Level 1, J-STD-020

Dimensions

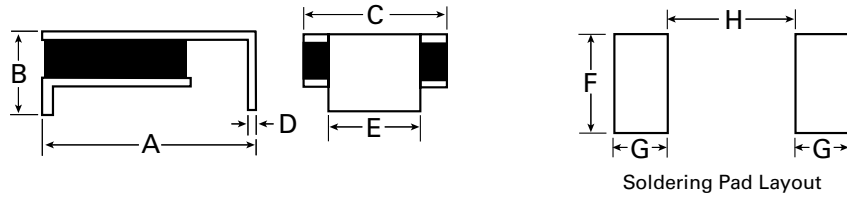

Part Number	A		B		C		D		E		Material	F		G		H	
	Inch	mm	Inch	mm	Inch	mm	Inch	mm	Inch	mm		Inch	mm	Inch	mm	Inch	mm
	Max.	Max.	Max.	Max.	Max.	Max.	Max.	Max.	Max.	Max.		Max.	Max.	Max.	Max.	Max.	Max.
250S130	0.37	9.4	0.15	3.7	0.29	7.4	0.016	0.4	0.15	3.8	Sn/Ni/Cu	0.18	4.6	0.07	1.8	0.24	6.1
250S130-RA	0.37	9.4	0.15	3.7	0.29	7.4	0.016	0.4	0.15	3.8	Sn/Ni/Cu	0.18	4.6	0.07	1.8	0.24	6.1
250S130-RB	0.37	9.4	0.15	3.7	0.29	7.4	0.016	0.4	0.15	3.8	Sn/Ni/Cu	0.18	4.6	0.07	1.8	0.24	6.1
250S130-RC	0.37	9.4	0.15	3.7	0.29	7.4	0.016	0.4	0.15	3.8	Sn/Ni/Cu	0.18	4.6	0.07	1.8	0.24	6.1

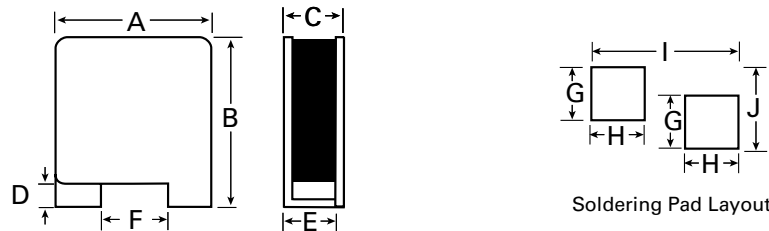

Part Number	A		B		C		D		E		F		Material	G		H		I		J	
	Inch	mm	Inch	mm	Inch	mm	Inch	mm	Inch	mm	Inch	mm		Inch	mm	Inch	mm	Inch	mm	Inch	mm
	Max.	Max.	Max.	Max.	Max.	Max.	Max.	Max.	Max.	Max.	Max.	Max.		Max.	Max.	Max.	Max.	Max.	Max.	Max.	Max.
250S130V	.24	6.1	.27	6.9	.13	3.2	.04	1.6	.07	1.9	.09	2.3	Sn/Ni/Cu	.09	2.3	.09	2.4	.25	6.4	.14	3.43

Part Ordering Number System

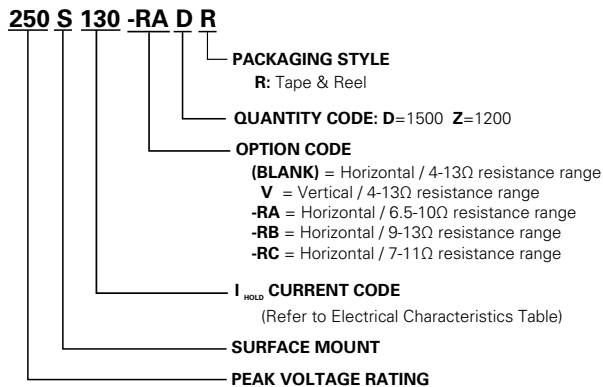

Packaging

Part Number	Ordering Number	I_{hold} (A)	I_{hold} Code	Packaging Option	Quantity	Quantity & Packaging Code
250S130	250S130DR	0.13	130	Tape and Reel	1500	DR
250S130V	250S130VZR	0.13	130	Tape and Reel	1200	ZR
250S130-RA	250S130-RADR	0.13	130	Tape and Reel	1500	DR
250S130-RB	250S130-RBDR	0.13	130	Tape and Reel	1500	DR
250S130-RC	250S130-RCDR	0.13	130	Tape and Reel	1500	DR

Tape and Reel Specifications

TAPE SPECIFICATIONS: EIA-481-1 (mm)	
W	16 +/-0.30
F	7.5 +/-0.05
E₁	1.75 +/-0.10
D₀	1.5 +/-0.05
D₁	1.00(MIN)
P₀	4.00 +/-0.10
P₁	12.00 +/-0.10
P₂	2.00 +/-0.05
A₀	6.9 +/-0.10
B₀	9.6 +/-0.10
T_{max}	0.4 +/-0.10
K₀	3.4 +/-0.15
Leader Min.	300
Trailer Min.	300

REEL DIMENSIONS: EIA-481-1 (mm)	
H	22.4 +/-0.05
W	16.4 .0 +0/+2
D	Ø60±0.5
F	Ø13.0±/-.2
C	Ø340±/-1.0
H₁	11±/-0.5
W₁	2.2±/-0.5
W₂	3.0±0.5
W₃	4.0±0.5
W₄	5.5±0.5

Tape and Reel Diagram

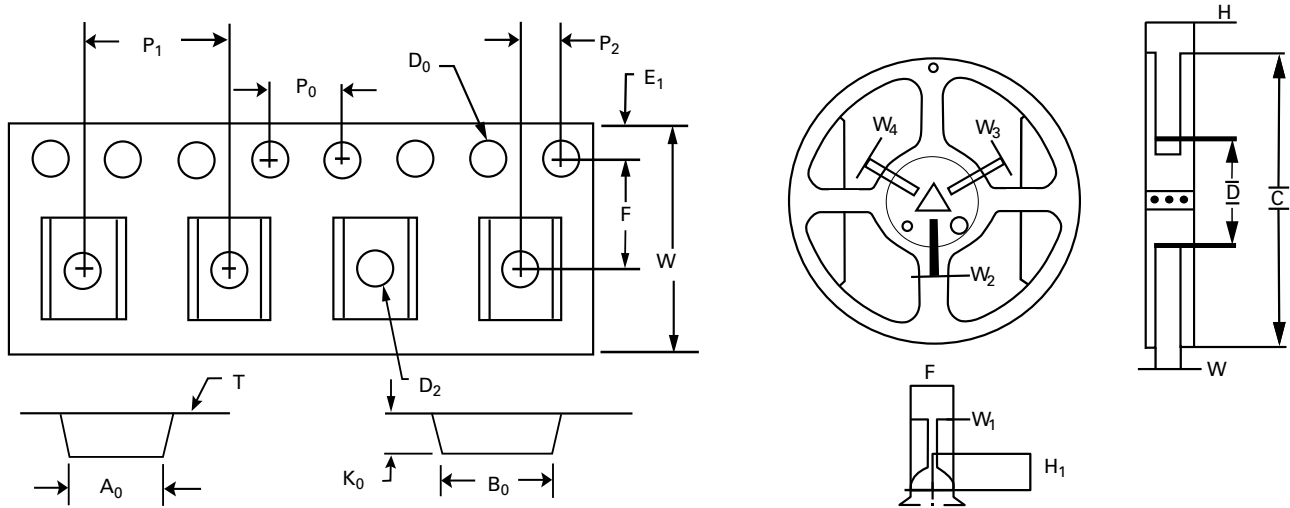

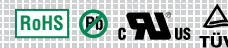

Disclaimer Notice - Information furnished is believed to be accurate and reliable. However, users should independently evaluate the suitability of and test each product selected for their own applications. Littelfuse products are not designed for, and may not be used in, all applications. Read complete Disclaimer Notice at www.littelfuse.com/disclaimer-electronics.

USBR Series



Agency Approvals

AGENCY	AGENCY FILE NUMBER
	E183209
	R50119318

Description

The USBR Series radial leaded device is designed to provide overcurrent protection for USB applications where space is not a concern.

Features

- RoHS compliant and lead-free
- Fast time-to-trip
- Meets all USB protection requirements
- 40A short circuit rating
- Operating voltages of 6-16V

Applications

- Computers & peripherals
- Any USB application

Additional Information



Datasheet





Resources



Samples

Electrical Characteristics

Part Number	I _{hold} (A)	I _{trip} (A)	V _{max} (Vdc)	I _{max} (A)	P _{d max.} (W)	Maximum Time To Trip		Resistance		Agency Approvals	
						Current (A)	Time (Sec.)	R _{min} (Ω)	R _{1max} (Ω)		
06R075B	0.75	1.30	6	40	0.3	8.00	0.4	0.100	0.230	X	X
06R120B	1.20	2.00	6	40	0.6	8.00	0.5	0.065	0.140	X	X
06R155B	1.55	2.70	6	40	0.6	7.75	2.2	0.040	0.100	X	X
16R090B	0.90	1.80	16	40	0.6	8.00	1.2	0.070	0.180	X	X
16R110B	1.10	2.20	16	40	0.7	8.00	2.3	0.050	0.140	X	X
16R135B	1.35	2.70	16	40	0.8	8.00	4.5	0.040	0.120	X	X
16R160B	1.60	3.20	16	40	0.9	8.00	9.0	0.030	0.110	X	X
16R185B	1.85	3.70	16	40	1.0	8.00	10.0	0.030	0.090	X	X
16R250B	2.50	5.00	16	40	1.2	8.00	40.0	0.020	0.060	X	X

I_{hold} = Hold current: maximum current device will pass without tripping in 20°C still air.

I_{trip} = Trip current: minimum current at which the device will trip in 20°C still air.

V_{max} = Maximum voltage device can withstand without damage at rated current (I_{max})

I_{max} = Maximum fault current device can withstand without damage at rated voltage (V_{max})

P_d = Power dissipated from device when in the tripped state at 20°C still air.

R_{min} = Minimum resistance of device in initial (un-soldered) state.

R_{typ} = Typical resistance of device in initial (un-soldered) state.

R_{1max} = Maximum resistance of device at 20°C measured one hour after tripping or reflow soldering of 260°C for 20 sec.

Caution: Operation beyond the specified rating may result in damage and possible arcing and flame.

WARNING

- Users shall independently assess the suitability of these devices for each of their applications
- Operation of these devices beyond the stated maximum ratings could result in damage to the devices and lead to electrical arcing and/or fire
- These devices are intended to protect against the effects of temporary over-current or over-temperature conditions and are not intended to perform as protective devices where such conditions are expected to be repetitive or prolonged in duration
- Exposure to silicon-based oils, solvents, electrolytes, acids, and similar materials can adversely affect the performance of these PPTC devices
- These devices undergo thermal expansion under fault conditions, and thus shall be provided with adequate space and be protected against mechanical stresses
- Circuits with inductance may generate a voltage (L di/dt) above the rated voltage of the PPTC device.

Temperature Derating

Part Number	Ambient Operation Temperature								
	-40°C	-20°C	0°C	20°C	40°C	50°C	60°C	70°C	85°C
06R075B	1.05	0.95	0.85	0.75	0.65	0.60	0.55	0.50	0.43
06R120B	1.69	1.52	1.36	1.20	1.04	0.96	0.88	0.80	0.68
06R155B	2.17	1.96	1.75	1.55	1.34	1.24	1.13	1.03	0.88
16R090B	1.31	1.17	1.04	0.90	0.75	0.69	0.61	0.55	0.47
16R110B	1.60	1.43	1.27	1.10	1.00	0.92	0.75	0.67	0.57
16R135B	1.96	1.76	1.55	1.35	1.12	1.04	0.92	0.82	0.70
16R160B	2.32	2.08	1.84	1.60	1.33	1.23	1.09	0.98	0.83
16R185B	2.68	2.41	2.13	1.85	1.54	1.42	1.26	1.13	0.96
16R250B	3.63	3.25	2.88	2.50	2.08	1.93	1.70	1.53	1.30

Average Time Current Curves

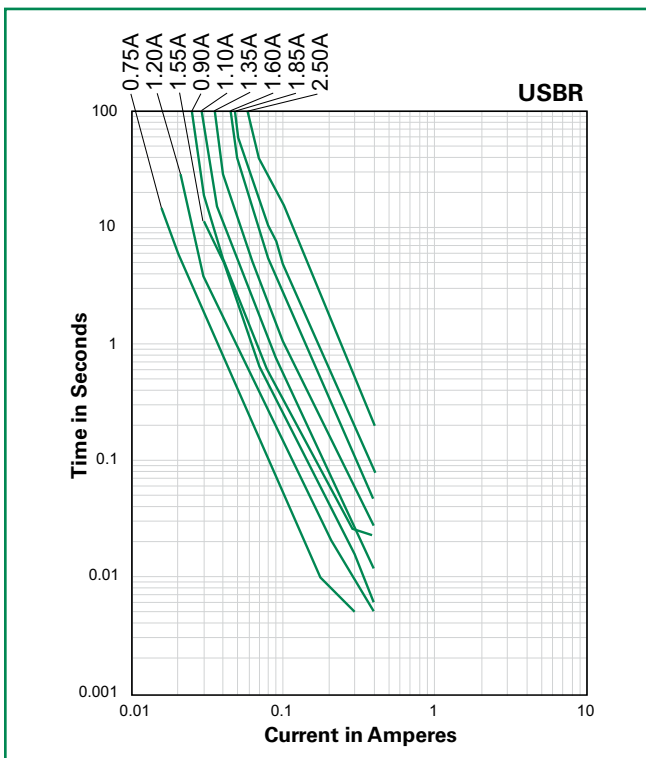

The average time current curves and Temperature Derating curve performance is affected by a number of variables, and these curves provided as guidance only. Customer must verify the performance in their application.

Temperature Derating Curve

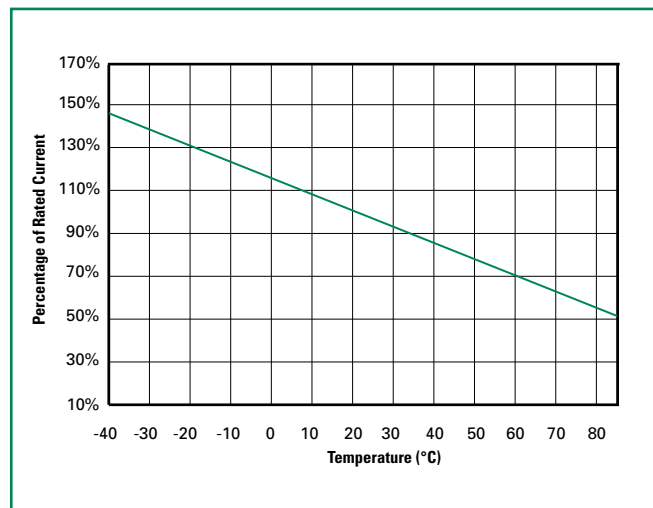

Note:
Typical Temperature derating curve, refer to table for derating data

Disclaimer Notice - Information furnished is believed to be accurate and reliable. However, users should independently evaluate the suitability of and test each product selected for their own applications. Littelfuse products are not designed for, and may not be used in, all applications. Read complete Disclaimer Notice at www.littelfuse.com/disclaimer-electronics.

Soldering Parameters

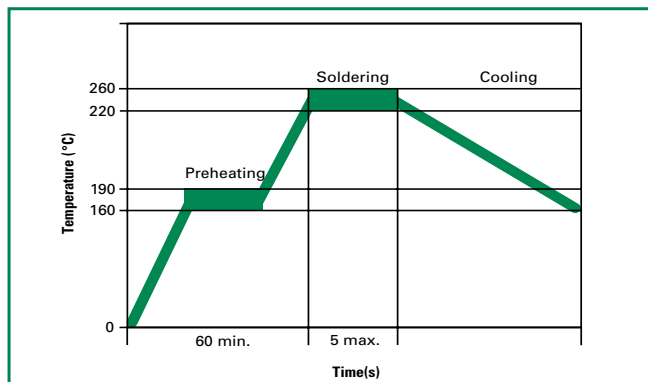

Pre-Heating Zone	Refer to the condition recommended by the flux manufacturer. Max. ramping rate should not exceed 4°C/Sec.
Soldering Zone	Max. solder temperature should not exceed 260°C Time within 5°C of actual Max. solder temperature within 3 – 5 seconds Total time from 25°C room to Max. solder temperature within 5 minutes including Pre-Heating time
Cooling Zone	Cooling by natural convection in air. Max. ramping down rate should not exceed 6°C/Sec.

Physical Specifications

Lead Material	.90-2.50A: Tin-plated Copper clad steel .75A: Tin-plated Copper
Soldering Characteristics	Solderability per MIL-STD-202, Method 208
Insulating Material	Cured, flame retardant epoxy polymer meets UL 94V-0 requirements.
Device Labeling	Marked with 'LF', voltage, current rating, and date code.

Environmental Specifications

Operating/Storage Temperature	-40°C to +85°C
Maximum Device Surface Temperature in Tripped State	125°C
Passive Aging	+85°C, 1000 hours -/+5% typical resistance change
Humidity Aging	+85°C, 85% R.H., 1000 hours -/+5% typical resistance change
Thermal Shock	+85°C to -40°C 10 times -/+5% typical resistance change
Solvent Resistance	MIL-STD-202, Method 215
Moisture Sensitivity Level	Level 1, J-STD-020

Dimensions (mm)

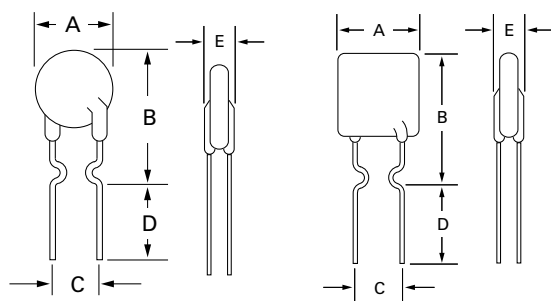
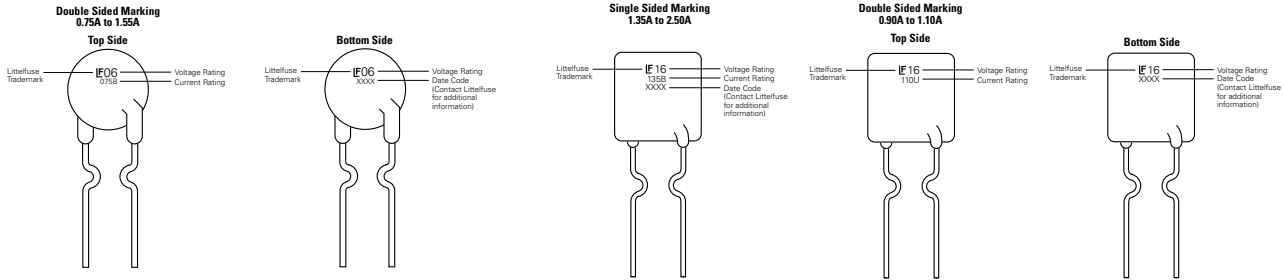

Figure 1

Figure 2

Part Number	Figure	A		B		C		D		E		Physical Characteristics		
		Inches	mm	Inches	mm	Inches	mm	Inches	mm	Inches	mm	Inches	mm	Material
		Max.	Max.	Max.	Max.	Typ.	Typ.	Min.	Min.	Max.	Max.	Lead (dia)		
06R075B	1	0.27	6.9	0.45	11.4	0.20	5.1	0.30	7.6	0.12	3	0.020	0.51	Sn/Cu
06R120B	1	0.27	6.9	0.46	11.7	0.20	5.1	0.30	7.6	0.12	3	0.020	0.51	Sn/CuFe
06R155B	1	0.27	6.9	0.46	11.7	0.20	5.1	0.30	7.6	0.12	3	0.020	0.51	Sn/CuFe
16R090B	2	0.29	7.4	0.48	12.2	0.20	5.1	0.30	7.6	0.12	3	0.020	0.51	Sn/CuFe
16R110B	2	0.29	7.4	0.56	14.2	0.20	5.1	0.30	7.6	0.12	3	0.020	0.51	Sn/CuFe
16R135B	2	0.35	8.9	0.53	13.5	0.20	5.1	0.30	7.6	0.12	3	0.020	0.51	Sn/CuFe
16R160B	2	0.35	8.9	0.60	15.2	0.20	5.1	0.30	7.6	0.12	3	0.020	0.51	Sn/CuFe
16R185B	2	0.40	10.2	0.62	15.7	0.20	5.1	0.30	7.6	0.12	3	0.020	0.51	Sn/CuFe
16R250B	2	0.45	11.4	0.72	18.3	0.20	5.1	0.30	7.6	0.12	3	0.020	0.51	Sn/CuFe

Part Marking System



Part Ordering Number System

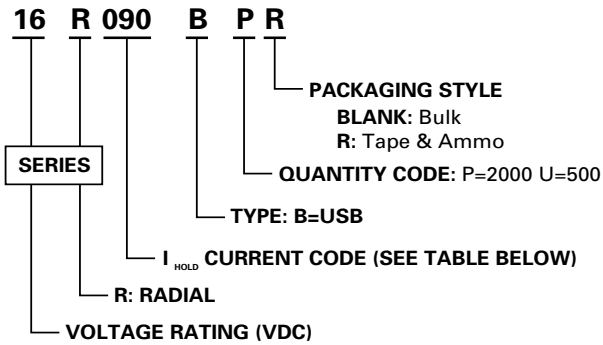

Ordering Information

Part Number	Ordering Number	I _{hold} (A)	I _{hold} Code	Packaging Option	Quantity	Quantity & Packaging Codes
06R075B	06R075BU	0.75	075	Bulk	500	U
	06R075BPR			Tape and Ammo	2000	PR
06R120B	06R120BU	1.20	120	Bulk	500	U
	06R120BPR			Tape and Ammo	2000	PR
06R155B	06R155BU	1.55	155	Bulk	500	U
	06R155BPR			Tape and Ammo	2000	PR
16R090B	16R090BU	0.90	090	Bulk	500	U
	16R090BPR			Tape and Ammo	2000	PR
16R110B	16R110BU	1.10	110	Bulk	500	U
	16R110BPR			Tape and Ammo	2000	PR
16R135B	16R135BU	1.35	135	Bulk	500	U
	16R135BPR			Tape and Ammo	2000	PR
16R160B	16R160BU	1.60	160	Bulk	500	U
	16R160BPR			Tape and Ammo	2000	PR
16R185B	16R185BU	1.85	185	Bulk	500	U
	16R185BPR			Tape and Ammo	2000	PR
16R250B	16R250BU	2.50	250	Bulk	500	U
	16R250BPR			Tape and Ammo	2000	PR

Tape and Ammo Specifications

Devices taped using EIA468-B/IE286-2 standards. See table below and Figure 1 for details.

Dimension	EIA Mark	IEC Mark	Dimensions	
			Dim. (mm)	Tol. (mm)
Carrier tape width	W	W	18	-0.5 / +1.0
Hold down tape width	W₄	W₀	11	min.
Top distance between tape edges	W₆	W₂	3	max.
Sprocket hole position	W₅	W₁	9	-0.5 / +0.75
Sprocket hole diameter*	D₀	D₀	4	-/+ 0.32
Abscissa to plane(straight lead)	H	H	18.5	-/+ 3.0
Abscissa to plane(kinked lead)	H₀	H₀	16	-/+ 0.5
Abscissa to top	H₁	H₁	32.2	max.
Overall width w/o lead protrusion	C₁		42.5	max.
Overall width w/ lead protrusion	C₂		43.2	max.
Lead protrusion	L₁	I₁	1.0	max.
Protrusion of cut out	L	L	11	max.
Protrusion beyond hold-down tape	I₂	I₂	Not specified	
Sprocket hole pitch	P₀	P₀	12.7	-/+ 0.35
Pitch tolerance			20 consecutive	-/+ 1
Device pitch			12.7	
Tape thickness	t	t	0.9	max.
Tape thickness with splice	t₁		2.0	max.
Splice sprocket hole alignment			0	-/+ 0.3
Body lateral deviation	Δh	Δh	0	-/+ 1.0
Body tape plane deviation	Δp	Δp	0	-/+ 1.3
Ordinate to adjacent component lead*	P₁	P₁	3.81	-/+ 1.0
Lead spacing*	F	F	5.08	-/+ 0.8

*Differs from EIA specification.

Tape and Ammo Diagram

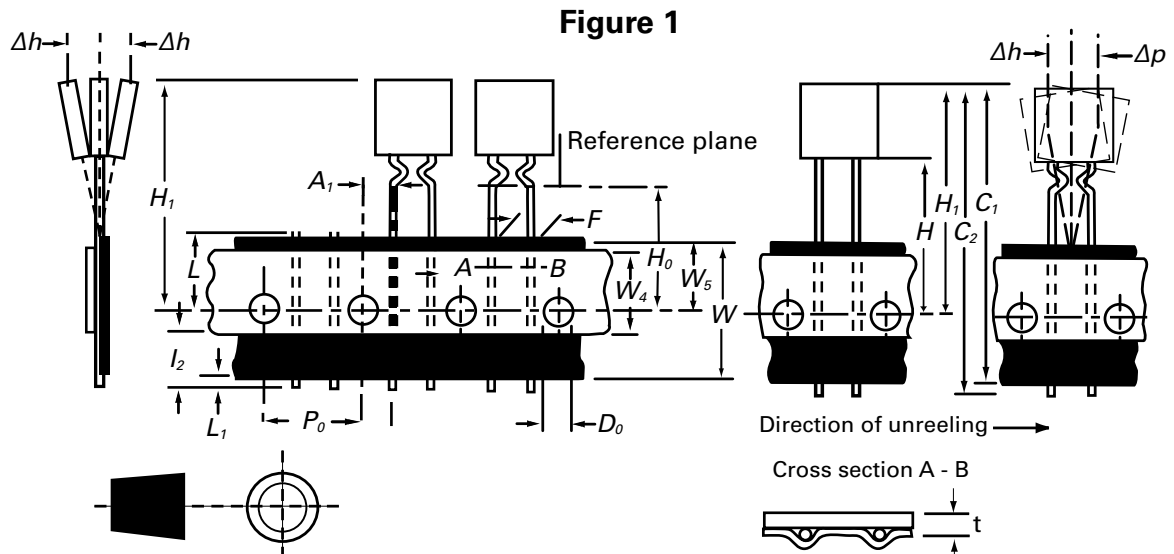

16R Series



Description

Littelfuse 16R Series Radial Leaded PTCs are designed to provide resettable overcurrent protection serving a wide range of electronics applications. With maximum 16 volts and maximum 100-ampere short circuit rating, they offer an ideal solution for USB protection.

Features

- 100A short circuit rating
- 16V Operating voltages
- Fast time-to-trip
- Meets all USB protection requirements
- RoHS compliant, Lead-Free and Halogen-Free*

Applications

- Computers & peripherals
- Any USB application
- General Electronics

Additional Information



Datasheet





Resources





Samples

Agency Approvals

AGENCY	AGENCY FILE NUMBER
	E183209
	R50119318

Electrical Characteristics

Part Number	I _{hold} (A)	I _{trip} (A)	V _{max} (Vdc)	I _{max} (A)	P _d typ. (W)	Maximum Time To Trip		Resistance		Agency Approvals	
						Current (A)	Time (Sec.)	R _{min} (Ω)	R _{1max} (Ω)		
16R250G	2.5	4.7	16	100	1.0	12.5	5.0	0.0220	0.0530	X	X
16R300G	3.0	5.1	16	100	2.3	15.0	1.0	0.0380	0.0975	X	X
16R400G	4.0	6.8	16	100	2.4	20.0	1.7	0.0210	0.0600	X	X
16R500G	5.0	8.5	16	100	2.6	25.0	2.0	0.0150	0.0340	X	X
16R600G	6.0	10.2	16	100	2.8	30.0	3.3	0.0100	0.0280	X	X
16R700G	7.0	11.9	16	100	3.0	35.0	3.5	0.0077	0.0200	X	X
16R800G	8.0	13.6	16	100	3.0	40.0	5.0	0.0056	0.0175	X	X
16R900G	9.0	15.3	16	100	3.3	45.0	5.5	0.0047	0.0135	X	X
16R1000G	10.0	17.0	16	100	3.6	50.0	6.0	0.0040	0.0102	X	X
16R1100G	11.0	18.7	16	100	3.7	55.0	7.0	0.0037	0.0089	X	X
16R1200G	12.0	20.4	16	100	4.2	60.0	7.5	0.0033	0.0086	X	X
16R1400G	14.0	23.8	16	100	4.6	70.0	9.0	0.0026	0.0064	X	X

I_{hold} = Hold current: maximum current device will pass without tripping in 20°C still air.

I_{trip} = Trip current: minimum current at which the device will trip in 20°C still air.

V_{max} = Maximum voltage device can withstand without damage at rated current (I_{max})

I_{max} = Maximum fault current device can withstand without damage at rated voltage (V_{max})

P_d = Power dissipated from device when in the tripped state at 20°C still air.

R_{min} = Minimum resistance of device in initial (un-soldered) state.

R_{1max} = Maximum resistance of device at 20°C measured one hour after tripping.

Caution: Operation beyond the specified rating may result in damage and possible arcing and flame.

* Effective January 1, 2010, all 16R PTC products will be manufactured Halogen Free (HF). Existing Non-Halogen Free 16R PTC products may continue to be sold, until supplies are depleted.

Temperature Derating

Part Number	Ambient Operation Temperature								
	-40°C	-20°C	0°C	20°C	40°C	50°C	60°C	70°C	85°C
16R250G	3.7	3.3	2.9	2.5	2.2	2.0	1.8	1.6	1.3
16R300G	4.4	4.0	3.5	3.0	2.6	2.4	2.1	1.9	1.6
16R400G	5.9	5.3	4.7	4.0	3.5	3.2	2.9	2.6	2.1
16R500G	7.4	6.6	5.9	5.0	4.4	4.0	3.6	3.2	2.6
16R600G	8.9	8.0	7.1	6.0	5.2	4.8	4.3	3.9	3.2
16R700G	10.4	9.3	8.2	7.0	6.1	5.6	5.0	4.5	3.7
16R800G	11.8	10.6	9.4	8.0	7.0	6.3	5.7	5.1	4.2
16R900G	13.3	12.0	10.6	9.0	7.8	7.1	6.5	5.8	4.7
16R1000G	14.8	13.3	11.8	10.0	8.7	7.9	7.1	6.4	5.3
16R1100G	16.3	14.6	12.9	11.0	9.6	8.7	7.9	7.0	5.8
16R1200G	17.7	15.9	14.1	12.0	10.5	9.5	8.6	7.7	6.3
16R1400G	20.7	18.6	16.5	14.0	12.2	11.1	10.0	9.0	7.4

Average Time Current Curves

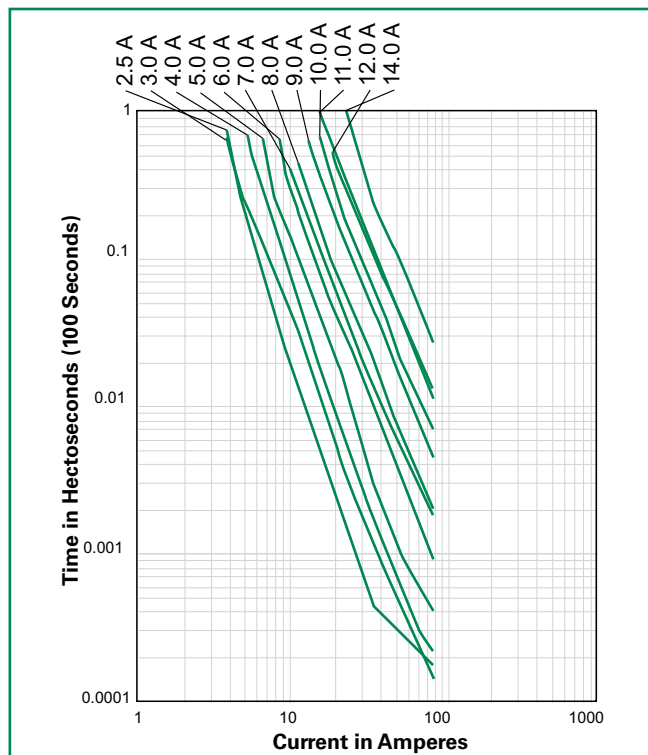

The average time current curves and Temperature Derating curve performance is affected by a number of variables, and these curves provided as guidance only. Customer must verify the performance in their application.

Temperature Derating Curve

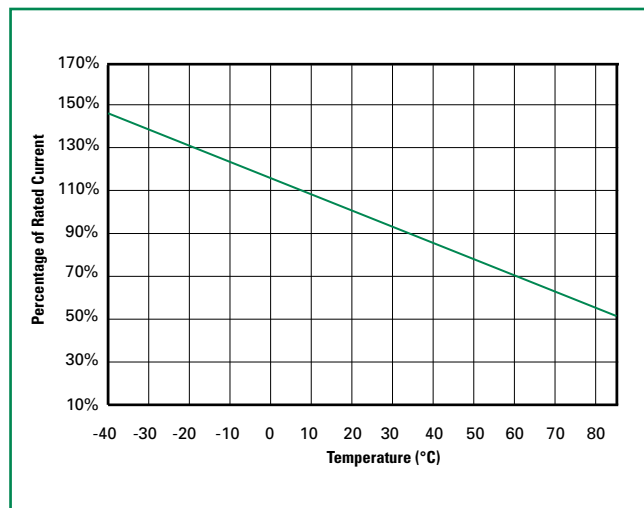

Note:
Typical Temperature derating curve, refer to table for derating data

Soldering Parameters - Wave Soldering

Pre-Heating Zone	Refer to the condition recommended by the flux manufacturer. Max. ramping rate should not exceed 4°C/Sec.
Soldering Zone	Max. solder temperature should not exceed 260°C Time within 5°C of actual Max. solder temperature within 3 – 5 seconds Total time from 25°C room to Max. solder temperature within 5 minutes including Pre-Heating time
Cooling Zone	Cooling by natural convection in air. Max. ramping down rate should not exceed 6°C/Sec.

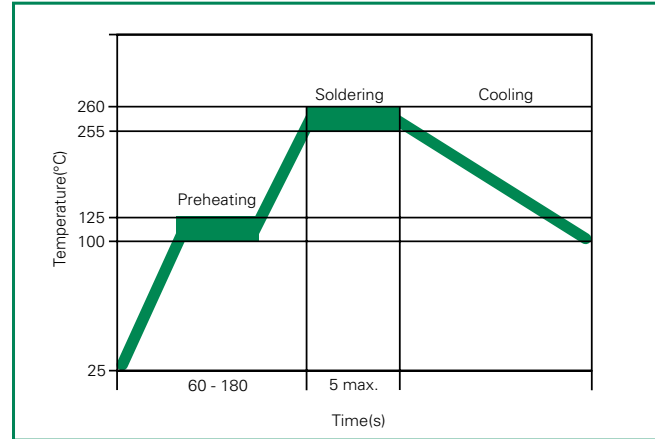

Physical Specifications

Lead Material	2.5A: Tin-plated Copper clad Steel 3.0 - 14.0A: Tin-plated Copper
Soldering Characteristics	Solderability per MIL-STD-202, Method 208
Insulating Material	Cured, flame retardant epoxy polymer meets UL 94V-0 requirements.
Device Labeling	Marked with 'LF', voltage, current rating, and date code.

Environmental Specifications

Operating/Storage Temperature	-40°C to +85°C
Maximum Device Surface Temperature in Tripped State	125°C
Passive Aging	+85°C, 1000 hours /+ 5% typical resistance change
Humidity Aging	+85°C, 85% R.H., 1000 hours /+ 5% typical resistance change
Thermal Shock	+85°C to -40°C 10 times /+ 5% typical resistance change
Solvent Resistance	MIL-STD-202, Method 215 No change
Moisture Resistance Level	Level 1, J-STD-020

Dimensions

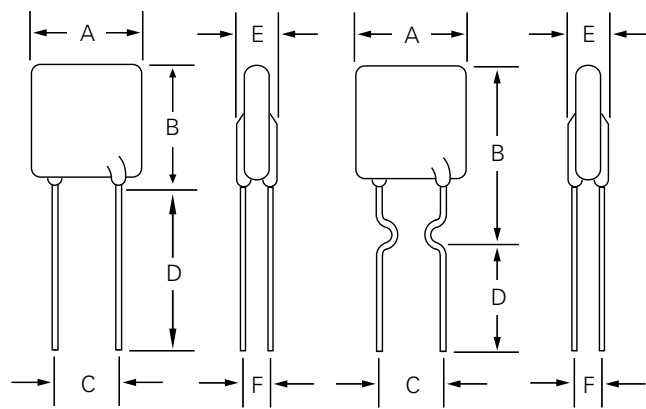
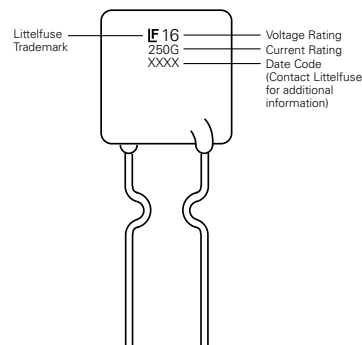

Figure 1

Figure 2

Part Marking System

Single Sided Marking



Part Number	Figure	A		B		C		D		E		F		Physical Characteristics		Material
		Inches	mm	Inches	mm	Inches	mm	Inches	mm	Inches	mm	Inches	mm	Lead (dia)		
		Max.	Max.	Max.	Max.	Typ.	Typ.	Min.	Min.	Max.	Max.	Typ.	Typ.	Inches	mm	
16R250G	2	0.35	8.90	0.50	12.80	0.20	5.1	0.13	3.18	0.12	3.00	0.035	0.9	0.020	0.51	Sn/CuFe
16R300G	1	0.28	7.10	0.43	11.00	0.20	5.1	0.30	7.6	0.12	3.00	0.047	1.2	0.032	0.81	Sn/Cu
16R400G	1	0.35	8.90	0.50	12.80	0.20	5.1	0.30	7.6	0.12	3.00	0.047	1.2	0.032	0.81	Sn/Cu
16R500G	1	0.41	10.40	0.56	14.30	0.20	5.1	0.30	7.6	0.12	3.00	0.047	1.2	0.032	0.81	Sn/Cu
16R600G	1	0.42	10.70	0.67	17.10	0.20	5.1	0.30	7.6	0.12	3.00	0.047	1.2	0.032	0.81	Sn/Cu
16R700G	1	0.44	11.20	0.78	19.70	0.20	5.1	0.30	7.6	0.12	3.00	0.047	1.2	0.032	0.81	Sn/Cu
16R700G KL	2	0.44	11.20	0.93	23.70	0.20	5.1	0.30	7.6	0.12	3.00	0.047	1.2	0.032	0.81	Sn/Cu
16R800G	1	0.50	12.70	0.82	20.90	0.20	5.1	0.30	7.6	0.12	3.00	0.047	1.2	0.032	0.81	Sn/Cu
16R900G	1	0.55	14.00	0.85	21.70	0.20	5.1	0.30	7.6	0.12	3.00	0.047	1.2	0.032	0.81	Sn/Cu
16R1000G	1	0.65	16.50	0.99	25.20	0.20	5.1	0.30	7.6	0.12	3.00	0.047	1.2	0.032	0.81	Sn/Cu
16R1100G	1	0.69	17.50	1.02	26.00	0.20	5.1	0.30	7.6	0.12	3.00	0.047	1.2	0.032	0.81	Sn/Cu
16R1200G	1	0.69	17.50	1.10	28.00	0.40	10.2	0.30	7.6	0.14	3.50	0.055	1.4	0.039	1.00	Sn/Cu
16R1400G	1	0.93	23.50	1.10	27.90	0.40	10.2	0.30	7.6	0.14	3.50	0.055	1.4	0.039	1.00	Sn/Cu

WARNING

- Users shall independently assess the suitability of these devices for each of their applications
- Operation of these devices beyond the stated maximum ratings could result in damage to the devices and lead to electrical arcing and/or fire
- These devices are intended to protect against the effects of temporary over-current or over-temperature conditions and are not intended to perform as protective devices where such conditions are expected to be repetitive or prolonged in duration
- Exposure to silicon-based oils, solvents, electrolytes, acids, and similar materials can adversely affect the performance of these PPTC devices
- These devices undergo thermal expansion under fault conditions, and thus shall be provided with adequate space and be protected against mechanical stresses
- Circuits with inductance may generate a voltage (L di/dt) above the rated voltage of the PPTC device.

Part Ordering Number System

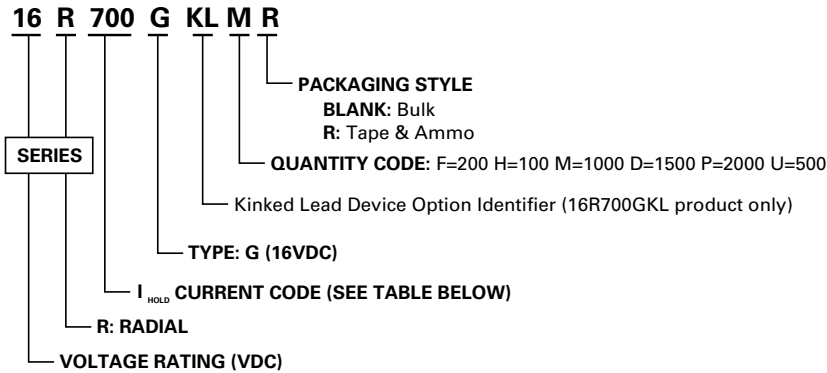

Packaging Options

Part Number	Ordering Number	I _{hold} (A)	I _{hold} Code	Packaging Option	Quantity	Quantity & Packaging Codes
16R250G	16R250GU	2.50	250	Bulk	500	U
	16R250GPR			Tape and Ammo	2000	PR
16R300G	16R300GU	3.00	300	Bulk	500	U
	16R300GPR			Tape and Ammo	2000	PR
16R400G	16R400GU	4.00	400	Bulk	500	U
	16R400GPR			Tape and Ammo	2000	PR
16R500G	16R500GU	5.00	500	Bulk	500	U
	16R500GPR			Tape and Ammo	2000	PR
16R600G	16R600GU	6.00	600	Bulk	500	U
	16R600GDR			Tape and Ammo	1500	DR
16R700G	16R700GF	7.00	700	Bulk	200	F
	16R700GKLF				Tape and Ammo	1000
	16R700GMR					
	16R700GKLMR					
16R800G	16R800GF	8.00	800	Bulk	200	F
	16R800GMR			Tape and Ammo	1000	MR
16R900G	16R900GF	9.00	900	Bulk	200	F
	16R900GMR			Tape and Ammo	1000	MR
16R1000G	16R1000GF	10.00	1000	Bulk	200	F
	16R1000GMR			Tape and Ammo	1000	MR
16R1100G	16R1100GF	11.00	1100	Bulk	200	F
	16R1100GMR			Tape and Ammo	1000	MR
16R1200G	16R1200GH	12.00	1200	Bulk	100	H
	16R1200GMR			Tape and Ammo	1000	MR
16R1400G	16R1400GH	14.00	1400	Bulk	100	H

Disclaimer Notice - Information furnished is believed to be accurate and reliable. However, users should independently evaluate the suitability of and test each product selected for their own applications. Littelfuse products are not designed for, and may not be used in, all applications. Read complete Disclaimer Notice at www.littelfuse.com/disclaimer-electronics.

Tape and Ammo Specifications

Devices taped using EIA468-B/IE286-2 standards. See table below and Figure 1 for details.

Dimension	EIA Mark	IEC Mark	Dimensions	
			Dim. (mm)	Tol. (mm)
Carrier tape width	W	W	18	-0.5 /+1.0
Hold down tape width:	W₄	W₀	11	min.
Top distance between tape edges	W₆	W₂	3	max.
Sprocket hole position	W₅	W₁	9	-0.5 /+0.75
Sprocket hole diameter*	D₀	D₀	4	-0.32 /+0.2
Abscissa to plane(straight lead)	H	H	18.5	-/+ 3.0
Abscissa to plane(kinked lead)	H₀	H₀	16	-/+ 0.5
Abscissa to top			45.0	max.
Overall width w/o lead protrusion			56	max.
Overall width w/ lead protrusion			57	max.
Lead protrusion	L₁	I₁	1.0	max.
Protrusion of cut out	L	L	11	max.
Protrusion beyond hold-down tape	I₂	I₂	Not specified	
Sprocket hole pitch	P₀	P₀	25.4	-/+ 0.5
Device pitch:			25.4	
Pitch tolerance			20 consecutive.	-/+ 1
Tape thickness	t	t	0.9	max.
Tape thickness with splice	t₁		2.0	max.
Splice sprocket hole alignment			0	-/+ 0.3
Body lateral deviation	Δh	Δh	0	-/+ 1.0
Body tape plane deviation	Δp	Δp	0	-/+ 1.3
Ordinate to adjacent component lead*	P₁	P₁	3.81	-/+ 0.7
Ordinate to adjacent component lead*			7.62	-/+ 0.7
Lead spacing:16R250G-16R1100G	F	F	5.08	-/+ 0.8
Lead spacing:16R1200G-16R1400G	F	F	10.18	-/+ 0.8

*Differs from EIA specification

Tape and Ammo Diagram

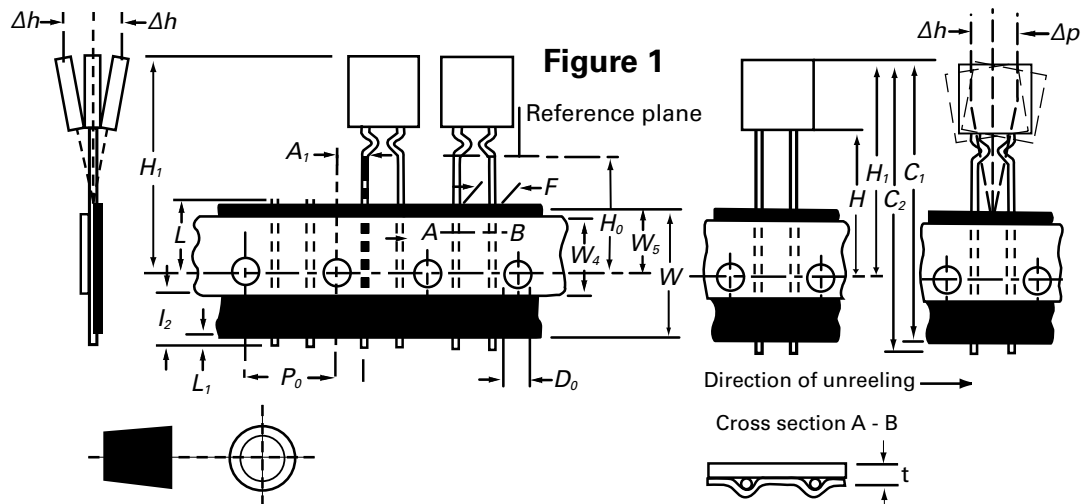

30R Series

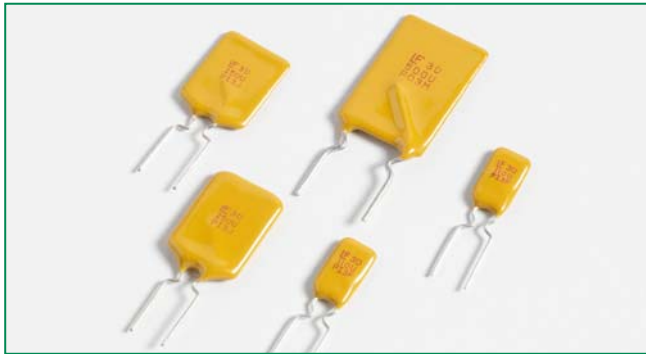

Description

The 30R Series radial leaded device is designed to provide overcurrent protection for low voltage ($\leq 30V$) applications where space is not a concern and resettable protection is preferred.



Features

- Cured, flame retardant epoxy polymer insulating material meets UL 94V-0 requirements
- Fast time-to-trip
- RoHS compliant, Lead-Free and Halogen-Free*

Applications

- USB hubs, ports and peripherals
- Computers & peripherals
- Motor protection
- General electronics
- Automotive applications

Agency Approvals

AGENCY	AGENCY FILE NUMBER
	E183209
	R50119318

Additional Information



Datasheet





Resources



Samples

Electrical Characteristics

Part Number	I_{hold} (A)	I_{trip} (A)	V_{max} (Vdc)	I_{max} (A)	P_d typ. (W)	Maximum Time To Trip		Resistance		Agency Approvals	
						Current (A)	Time (Sec.)	R_{min} (Ω)	R_{1max} (Ω)		
30R090U	0.90	1.80	30	40	0.6	4.50	5.90	0.070	0.220	X	X
30R110U	1.10	2.20	30	40	0.7	5.50	6.60	0.050	0.170	X	X
30R135U	1.35	2.70	30	40	0.8	6.75	7.30	0.040	0.130	X	X
30R160U	1.60	3.20	30	40	0.9	8.00	8.00	0.030	0.110	X	X
30R185U	1.85	3.70	30	40	1.0	9.25	8.70	0.030	0.090	X	X
30R250U	2.50	5.00	30	40	1.2	12.50	10.30	0.020	0.070	X	X
30R300U	3.00	6.00	30	40	2.0	15.00	10.80	0.020	0.080	X	X
30R400U	4.00	8.00	30	40	2.5	20.00	12.70	0.010	0.050	X	X
30R500U	5.00	10.00	30	40	3.0	25.00	14.50	0.010	0.050	X	X
30R600U	6.00	12.00	30	40	3.5	30.00	16.00	0.005	0.040	X	X
30R700U	7.00	14.00	30	40	3.8	35.00	17.50	0.005	0.030	X	X
30R800U	8.00	16.00	30	40	4.0	40.00	18.80	0.005	0.020	X	X
30R900U	9.00	18.00	30	40	4.2	40.00	20.00	0.005	0.020	X	X

I_{hold} = Hold current: maximum current device will pass without tripping in 20°C still air.

I_{trip} = Trip current: minimum current at which the device will trip in 20°C still air.

V_{max} = Maximum voltage device can withstand without damage at rated current (I_{max})

I_{max} = Maximum fault current device can withstand without damage at rated voltage (V_{max})

P_d = Power dissipated from device when in the tripped state at 20°C still air.

R_{min} = Minimum resistance of device in initial (un-soldered) state.

R_{1max} = Maximum resistance of device at 20°C measured one hour after tripping.

Caution: Operation beyond the specified rating may result in damage and possible arcing and flame.

* Effective January 1, 2010, all 30R PTC products will be manufactured Halogen Free (HF). Existing Non-Halogen Free 30R PTC products may continue to be sold, until supplies are depleted.

Temperature Derating

Part Number	Ambient Operation Temperature								
	-40°C	-20°C	0°C	20°C	40°C	50°C	60°C	70°C	85°C
30R090U	1.31	1.17	1.04	0.90	0.75	0.69	0.61	0.55	0.47
30R110U	1.60	1.43	1.27	1.10	0.91	0.85	0.75	0.67	0.57
30R135U	1.96	1.76	1.55	1.35	1.12	1.04	0.92	0.82	0.70
30R160U	2.32	2.08	1.84	1.60	1.33	1.23	1.09	0.98	0.83
30R185U	2.68	2.41	2.13	1.85	1.54	1.42	1.26	1.13	0.96
30R250U	3.63	3.25	2.88	2.50	2.08	1.93	1.70	1.53	1.30
30R300U	4.35	3.90	3.45	3.00	2.49	2.31	2.04	1.83	1.56
30R400U	5.80	5.20	4.60	4.00	3.32	3.08	2.72	2.44	2.08
30R500U	7.25	6.50	5.75	5.00	4.15	3.85	3.40	3.05	2.60
30R600U	8.70	7.80	6.90	6.00	4.98	4.62	4.08	3.66	3.12
30R700U	10.15	9.10	8.05	7.00	5.81	5.39	4.76	4.27	3.64
30R800U	11.60	10.40	9.20	8.00	6.64	6.16	5.44	4.88	4.16
30R900U	13.05	11.70	10.35	9.00	7.47	6.93	6.12	5.49	4.68

Average Time Current Curves

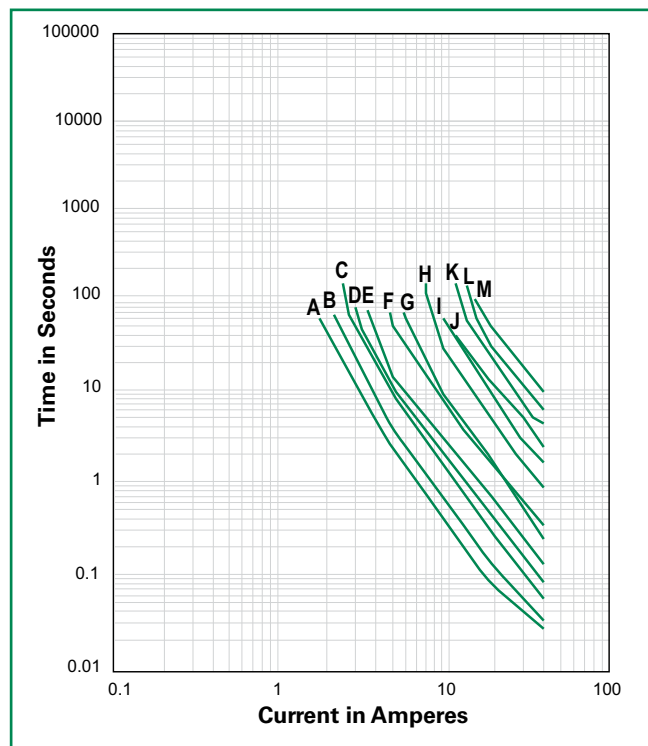

The average time current curves and Temperature Derating curve performance is affected by a number of variables, and these curves provided as guidance only. Customer must verify the performance in their application.

Temperature Derating Curve

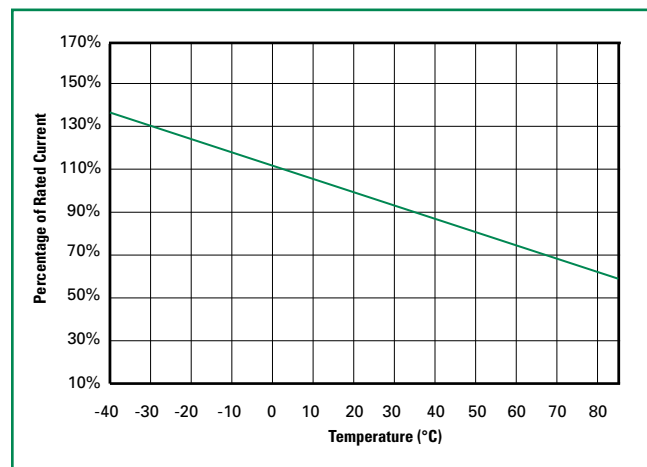

Note:
Typical Temperature derating curve, refer to table for derating data

Soldering Parameters - Wave Soldering

Pre-Heating Zone	Refer to the condition recommended by the flux manufacturer. Max. ramping rate should not exceed 4°C/Sec.
Soldering Zone	Max. solder temperature should not exceed 260°C Time within 5°C of actual Max. solder temperature within 3 - 5 seconds Total time from 25°C room to Max. solder temperature within 5 minutes including Pre-Heating time
Cooling Zone	Cooling by natural convection in air. Max. ramping down rate should not exceed 6°C/Sec.

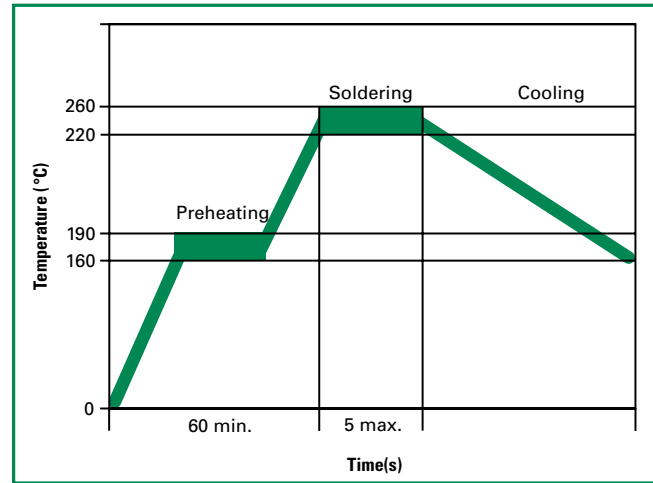

Physical Specifications

Lead Material	0.90-1.85A: Tin-plated Copper clad steel 2.50-9.00A: Tin-plated Copper
Soldering Characteristics	Solderability per MIL-STD-202, Method 208
Insulating Material	Cured, flame retardant epoxy polymer meets UL94V-0 requirements.
Device Labeling	Marked with 'LF', voltage, current rating, and date code.

Environmental Specifications

Operating/Storage Temperature	-40°C to +85°C
Maximum Device Surface Temperature in Tripped State	125°C
Passive Aging	+85°C, 1000 hours -/+5% typical resistance change
Humidity Aging	+85°C, 85% R.H., 1000 hours -/+5% typical resistance change
Thermal Shock	+85°C to -40°C 10 times -/+5% typical resistance change
Solvent Resistance	MIL-STD-202, Method 215 No change
Moisture Resistance Level	Level 1, J-STD-020

Dimensions

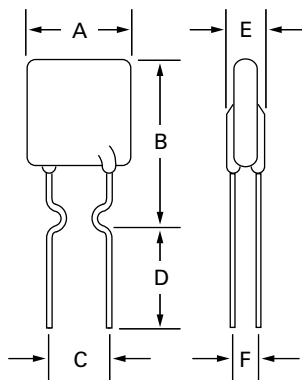

Part Marking System

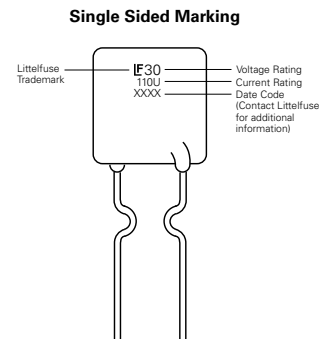

Part Number	A		B		C		D		E		F		Physical Characteristics		
	Inches	mm	Inches	mm	Inches	mm	Inches	mm	Inches	mm	Inches	mm	Lead (dia)		Material
	Max.	Max.	Max.	Max.	Typ.	Typ.	Min.	Min.	Max.	Max.	Typ.	Typ.	Inches	mm	
30R090U	0.29	7.40	0.48	12.20	0.20	5.10	0.30	7.60	0.12	3.00	0.039	1.0	0.02	0.51	Sn/CuFe
30R110U	0.29	7.40	0.56	14.20	0.20	5.10	0.30	7.60	0.12	3.00	0.039	1.0	0.02	0.51	Sn/CuFe
30R135U	0.35	8.90	0.53	13.50	0.20	5.10	0.30	7.60	0.12	3.00	0.039	1.0	0.02	0.51	Sn/CuFe
30R160U	0.35	8.90	0.60	15.20	0.20	5.10	0.30	7.60	0.12	3.00	0.039	1.0	0.02	0.51	Sn/CuFe
30R185U	0.40	10.20	0.62	15.70	0.20	5.10	0.30	7.60	0.12	3.00	0.039	1.0	0.02	0.51	Sn/CuFe
30R250U	0.45	11.40	0.72	18.30	0.20	5.10	0.30	7.60	0.12	3.00	0.039	1.0	0.02	0.51	Sn/Cu
30R300U	0.45	11.40	0.76	19.20	0.20	5.10	0.30	7.60	0.12	3.00	0.047	1.2	0.03	0.81	Sn/Cu
30R400U	0.55	14.00	0.87	22.00	0.20	5.10	0.30	7.60	0.12	3.00	0.047	1.2	0.03	0.81	Sn/Cu
30R500U	0.55	14.00	1.01	25.60	0.40	10.20	0.30	7.60	0.12	3.00	0.047	1.2	0.03	0.81	Sn/Cu
30R600U	0.65	16.50	1.06	26.80	0.40	10.20	0.30	7.60	0.12	3.00	0.047	1.2	0.03	0.81	Sn/Cu
30R700U	0.75	19.10	1.13	28.60	0.40	10.20	0.30	7.60	0.12	3.00	0.047	1.2	0.03	0.81	Sn/Cu
30R800U	0.85	21.60	1.22	31.10	0.40	10.20	0.30	7.60	0.12	3.00	0.047	1.2	0.03	0.81	Sn/Cu
30R900U	0.95	24.10	1.24	31.60	0.40	10.20	0.30	7.60	0.12	3.00	0.047	1.2	0.03	0.81	Sn/Cu

Part Ordering Number System

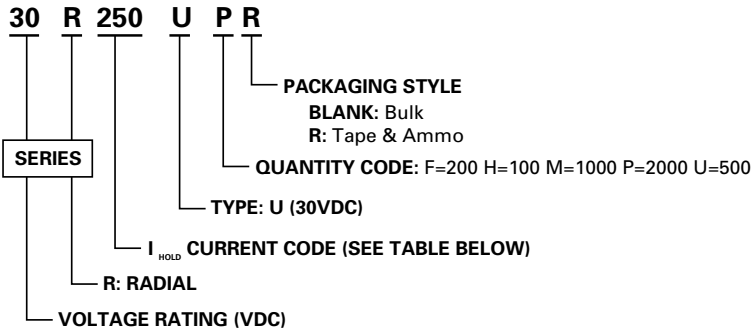

Packaging

Part Number	Ordering Number	I _{hold} (A)	I _{hold} Code	Packaging Option	Quantity	Quantity & Packaging Codes
30R090U	30R090UU	0.90	090	Bulk	500	U
	30R090UPR			Tape and Ammo	2000	PR
30R110U	30R110UU	1.10	110	Bulk	500	U
	30R110UPR			Tape and Ammo	2000	PR
30R135U	30R135UU	1.35	135	Bulk	500	U
	30R135UPR			Tape and Ammo	2000	PR
30R160U	30R160UU	1.60	160	Bulk	500	U
	30R160UPR			Tape and Ammo	2000	PR
30R185U	30R185UU	1.85	185	Bulk	500	U
	30R185UPR			Tape and Ammo	2000	PR
30R250U	30R250UU	2.50	250	Bulk	500	U
	30R250UPR			Tape and Ammo	2000	PR
30R300U	30R300UU	3.00	300	Bulk	500	U
	30R300UPR			Tape and Ammo	2000	PR
30R400U	30R400UF	4.00	400	Bulk	200	F
	30R400UMR			Tape and Ammo	1000	MR
30R500U	30R500UF	5.00	500	Bulk	200	F
	30R500UMR			Tape and Ammo	1000	MR
30R600U	30R600UF	6.00	600	Bulk	200	F
	30R600UMR			Tape and Ammo	1000	MR
30R700U	30R700UF	7.00	700	Bulk	200	F
	30R700UMR			Tape and Ammo	1000	MR
30R800U	30R800UH	8.00	800	Bulk	100	H
30R900U	30R900UH	9.00	900	Bulk	100	H

Tape and Ammo Specifications

Devices taped using EIA468-B/IE286-2 standards. See table below and Figure 1 for details.

Dimension	EIA Mark	IEC Mark	Dimensions	
			Dim. (mm)	Tol. (mm)
Carrier tape width	W	W	18	-0.5 / +1.0
Hold down tape width:	W₄	W₀	11	min.
Top distance between tape edges	W₆	W₂	3	max.
Sprocket hole position	W₅	W₁	9	-0.5 / +0.75
Sprocket hole diameter*	D₀	D₀	4	-0.32 / +0.2
Abscissa to plane(straight lead)	H	H	18.5	-/+ 3.0
Abscissa to plane(kinked lead)	H₀	H₀	16	-/+ 0.5
Abscissa to top: 30R090-30R185	H₁	H₁	32.2	max.
Abscissa to top: 30R250-30R900			45.0	max.
Overall width w/o lead protrusion: 30R090-30R185	C₁		42.5	max.
Overall width w/o lead protrusion: 30R250-30R900			56	max.
Overall width w/ lead protrusion: 30R090-30R185	C₂		43.2	max.
Overall width w/ lead protrusion: 30R250-30R900			57	max.
Lead protrusion	L₁	L₁	1.0	max.
Protrusion of cut out	L	L	11	max.
Protrusion beyond hold-down tape	L₂	L₂	Not specified	
Sprocket hole pitch: 30R090-30R300	P₀	P₀	12.7	-/+ 0.3
Sprocket hole pitch on: 30R400-30R900	P₀	P₀	25.4	-/+ 0.5
Device pitch: 30R090-30R300			12.7	
Device pitch: 30R400-30R900			25.4	
Pitch tolerance			20 consecutive.	-/+ 1
Tape thickness	t	t	0.9	max.
Tape thickness with splice: 30R090-30R250	t₁		1.5	max.
Tape thickness with splice: 30R300-30R900	t₁		2.0	max.
Splice sprocket hole alignment			0	-/+ 0.3
Body lateral deviation	Δh	Δh	0	-/+ 1.0
Body tape plane deviation	Δp	Δp	0	-/+ 1.3
Ordinate to adjacent component lead*	P₁	P₁	3.81	-/+ 0.7
Ordinate to adjacent component lead*			7.62	-/+ 0.7
Lead spacing: 30R090-30R400	F	F	5.08	-/+ 0.8
Lead spacing: 30R500-30R900	F	F	10.18	-/+ 0.8

*Differs from EIA Specification

WARNING

- Users shall independently assess the suitability of these devices for each of their applications
- Operation of these devices beyond the stated maximum ratings could result in damage to the devices and lead to electrical arcing and/or fire
- These devices are intended to protect against the effects of temporary over-current or over-temperature conditions and are not intended to perform as protective devices where such conditions are expected to be repetitive or prolonged in duration
- Exposure to silicon-based oils, solvents, electrolytes, acids, and similar materials can adversely affect the performance of these PPTC devices
- These devices undergo thermal expansion under fault conditions, and thus shall be provided with adequate space and be protected against mechanical stresses
- Circuits with inductance may generate a voltage (L di/dt) above the rated voltage of the PPTC device.

Tape and Ammo Diagram

Figure 1

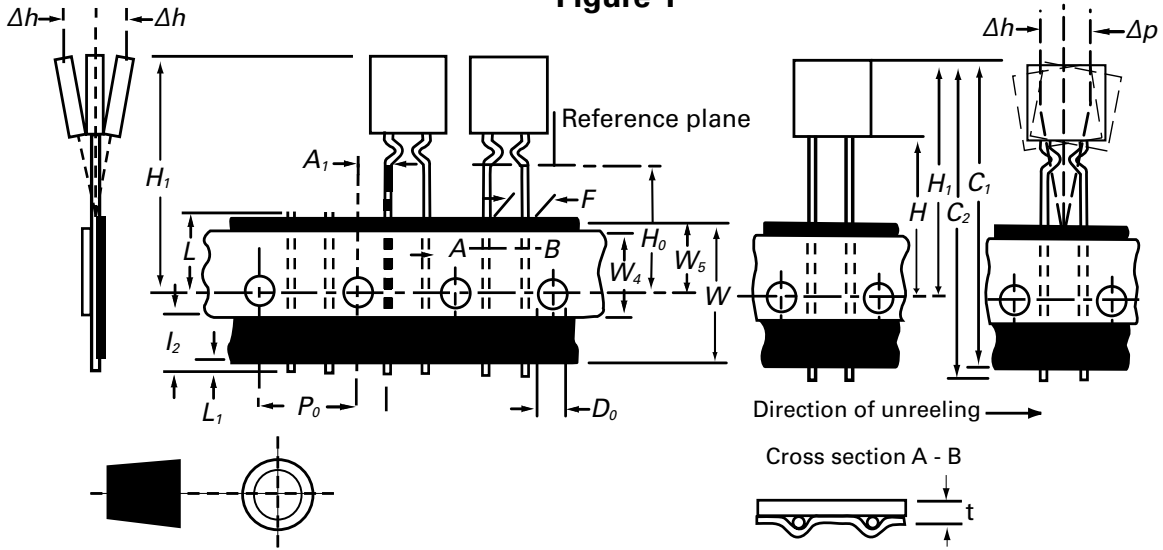



Disclaimer Notice - Information furnished is believed to be accurate and reliable. However, users should independently evaluate the suitability of and test each product selected for their own applications. Littelfuse products are not designed for, and may not be used in, all applications. Read complete Disclaimer Notice at www.littelfuse.com/disclaimer-electronics.

60R Series



Agency Approvals

AGENCY	AGENCY FILE NUMBER	60R010X & 60R017X
	E183209	E183209
	R50119318	N/A

Description

The 60R Series radial leaded device is designed to provide overcurrent protection for ($\leq 60V$) applications where space is not a concern and resettable protection is preferred.



Features

- Cured, flame retardant epoxy polymer insulating material meets UL 94V-0 requirements
- Fast time-to-trip
- RoHS compliant, Lead-Free and Halogen-Free*

Applications

- USB hubs, ports and peripherals
- IEEE1394 ports
- Computers & peripherals
- Motor protection
- General electronics
- Automotive applications
- Industrial controls
- Transformers

Electrical Characteristics

Part Number	I_{hold} (A)	I_{trip} (A)	V_{max} (Vdc)	I_{max} (A)	$P_{d,typ.}$ (W)	Maximum Time To Trip		Resistance		Agency Approvals	
						Current (A)	Time (Sec.)	R_{min} (Ω)	R_{1max} (Ω)		
60R010X	0.10	0.20	60	40	0.38	0.50	4.00	2.500	7.500	X	
60R017X	0.17	0.34	60	40	0.48	0.85	3.00	3.300	8.000	X	
60R020X	0.20	0.40	60	40	0.41	1.00	2.20	1.830	4.400	X	X
60R025X	0.25	0.50	60	40	0.45	1.25	2.50	1.250	3.000	X	X
60R030X	0.30	0.60	60	40	0.49	1.50	3.00	0.880	2.100	X	X
60R040X	0.40	0.80	60	40	0.56	2.00	3.80	0.550	1.290	X	X
60R050X	0.50	1.00	60	40	0.77	2.50	4.00	0.500	1.170	X	X
60R065X	0.65	1.30	60	40	0.88	3.25	5.30	0.310	0.720	X	X
60R075X	0.75	1.50	60	40	0.92	3.75	6.30	0.250	0.600	X	X
60R090X	0.90	1.80	60	40	0.99	4.50	7.20	0.200	0.470	X	X
60R110X	1.10	2.20	60	40	1.50	5.50	8.20	0.150	0.380	X	X
60R135X	1.35	2.70	60	40	1.70	6.75	9.60	0.120	0.300	X	X
60R160X	1.60	3.20	60	40	1.90	8.00	11.40	0.090	0.220	X	X
60R185X	1.85	3.70	60	40	2.10	9.25	12.60	0.080	0.190	X	X
60R250X	2.50	5.00	60	40	2.50	12.50	15.60	0.050	0.130	X	X
60R300X	3.00	6.00	60	40	2.80	15.00	19.80	0.040	0.100	X	X
60R375X	3.75	7.50	60	40	3.20	18.75	24.00	0.030	0.080	X	X

I_{hold} = Hold current: maximum current device will pass without tripping in 20°C still air.
 I_{trip} = Trip current: minimum current at which the device will trip in 20°C still air.
 V_{max} = Maximum voltage device can withstand without damage at rated current (I_{max})
 I_{max} = Maximum fault current device can withstand without damage at rated voltage (V_{max})
 P_d = Power dissipated from device when in the tripped state at 20°C still air.

R_{min} = Minimum resistance of device in initial (un-soldered) state.
 R_{typ} = Typical resistance of device in initial (un-soldered) state.
 R_{1max} = Maximum resistance of device at 20°C measured one hour after tripping or reflow soldering of 260°C for 20 sec.

Caution: Operation beyond the specified rating may result in damage and possible arcing and flame.

* Effective January 1, 2010, all 60R PTC products will be manufactured Halogen Free (HF). Existing Non-Halogen Free 60R PTC products may continue to be sold, until supplies are depleted.

Temperature Derating

Part Number	Ambient Operation Temperature								
	-40°C	-20°C	0°C	20°C	40°C	50°C	60°C	70°C	85°C
	Hold Current (A)								
60R010X	0.16	0.14	0.12	0.10	0.08	0.07	0.06	0.05	0.04
60R017X	0.26	0.23	0.20	0.17	0.14	0.12	0.11	0.09	0.07
60R020X	0.31	0.27	0.24	0.20	0.16	0.14	0.13	0.11	0.08
60R025X	0.39	0.34	0.30	0.25	0.20	0.18	0.16	0.14	0.10
60R030X	0.47	0.41	0.36	0.30	0.24	0.22	0.19	0.16	0.12
60R040X	0.62	0.54	0.48	0.40	0.32	0.29	0.25	0.22	0.16
60R050X	0.78	0.68	0.60	0.50	0.41	0.36	0.32	0.27	0.20
60R065X	1.01	0.88	0.77	0.65	0.53	0.47	0.41	0.35	0.26
60R075X	1.16	1.02	0.89	0.75	0.61	0.54	0.47	0.41	0.30
60R090X	1.40	1.22	1.07	0.90	0.73	0.65	0.57	0.49	0.36
60R110X	1.71	1.50	1.31	1.10	0.89	0.79	0.69	0.59	0.44
60R135X	2.09	1.84	1.61	1.35	1.09	0.97	0.85	0.73	0.54
60R160X	2.48	2.18	1.90	1.60	1.30	1.15	1.01	0.86	0.64
60R185X	2.87	2.52	2.20	1.85	1.50	1.33	1.17	1.00	0.74
60R250X	3.88	3.40	2.98	2.50	2.03	1.80	1.58	1.35	1.00
60R300X	4.65	4.08	3.57	3.00	2.43	2.16	1.89	1.62	1.20
60R375X	5.81	5.10	4.46	3.75	3.04	2.70	2.36	2.03	1.50

Average Time Current Curves

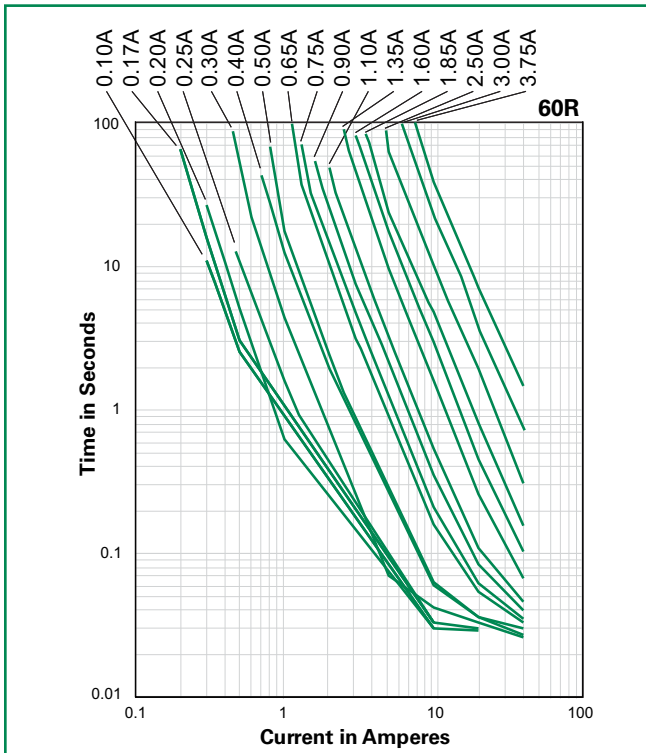

The average time current curves and Temperature Derating curve performance is affected by a number of variables, and these curves provided as guidance only. Customer must verify the performance in their application.

Temperature Derating Curve

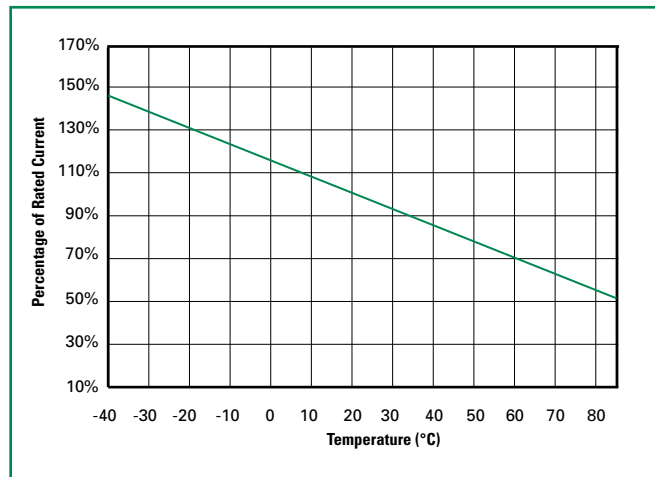

Note:
Typical Temperature derating curve, refer to table for derating data

Soldering Parameters - Wave Soldering

Pre-Heating Zone	Refer to the condition recommended by the flux manufacturer. Max. ramping rate should not exceed 4°C/Sec.
Soldering Zone	Max. solder temperature should not exceed 260°C Time within 5°C of actual Max. solder temperature within 3 - 5 seconds Total time from 25°C room to Max. solder temperature within 5 minutes including Pre-Heating time
Cooling Zone	Cooling by natural convection in air. Max. ramping down rate should not exceed 6°C/Sec.

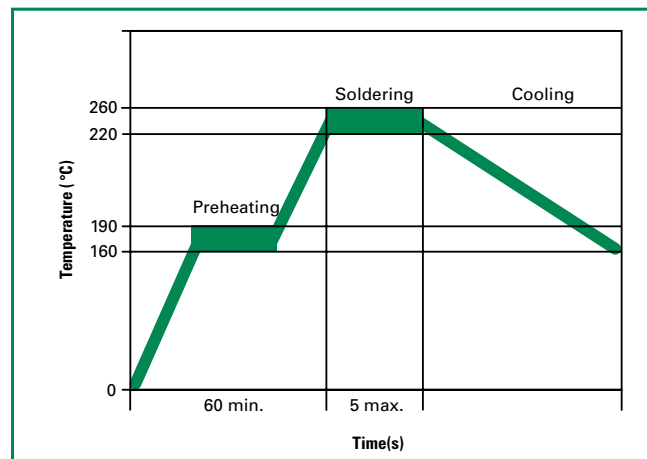

Physical Specifications

Lead Material	.20-.40A: Tin-plated Copper clad steel .50-3.75A: Tin-plated Copper
Soldering Characteristics	Solderability per MIL-STD-202, Method 208
Insulating Material	Cured, flame retardant epoxy polymer meets UL94V-0 requirements.
Device Labeling	Marked with 'LF', voltage, current rating, and date code.

Environmental Specifications

Operating/Storage Temperature	-40°C to +85°C
Maximum Device Surface Temperature in Tripped State	125°C
Passive Aging	+85°C, 1000 hours -/+ 5% typical resistance change
Humidity Aging	+85°C, 85% R.H., 1000 hours -/+ 5% typical resistance change
Thermal Shock	+85°C to -40°C 10 times -/+ 5% typical resistance change
Solvent Resistance	MIL-STD-202, Method 215
Moisture Resistance Level	Level 1, J-STD-020

Additional Information



Datasheet



Resources



Samples

Dimensions

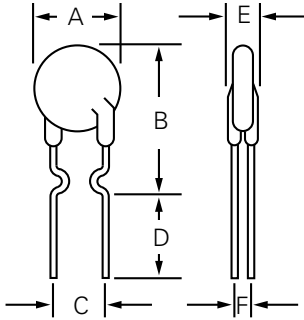

Part Marking System

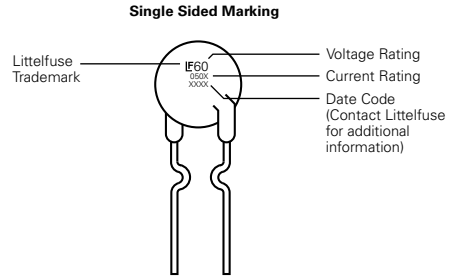

Part Number	A		B		C		D		E		F		Physical Characteristics		
	Inches	mm	Inches	mm	Inches	mm	Inches	mm	Inches	mm	Inches	mm	Lead (dia)		Material
	Max.	Max.	Max.	Max.	Typ.	Typ.	Min.	Min.	Max.	Max.	Typ.	Typ.	Inches	mm	
60R010X	0.29	7.4	0.50	12.7	0.20	5.1	0.30	7.6	0.12	3.1	0.047	1.2	0.02	0.51	Sn/CuFe
60R017X	0.29	7.4	0.50	12.7	0.20	5.1	0.30	7.6	0.12	3.1	0.047	1.2	0.02	0.51	Sn/CuFe
60R020X	0.29	7.4	0.46	11.7	0.20	5.1	0.30	7.6	0.12	3.1	0.047	1.2	0.02	0.51	Sn/CuFe
60R025X	0.29	7.4	0.50	12.7	0.20	5.1	0.30	7.6	0.12	3.1	0.047	1.2	0.02	0.51	Sn/CuFe
60R030X	0.29	7.4	0.50	12.7	0.20	5.1	0.30	7.6	0.12	3.1	0.047	1.2	0.02	0.51	Sn/CuFe
60R040X	0.30	7.6	0.53	13.5	0.20	5.1	0.30	7.6	0.12	3.1	0.047	1.2	0.02	0.51	Sn/CuFe
60R050X	0.31	7.9	0.54	13.7	0.20	5.1	0.30	7.6	0.12	3.1	0.047	1.2	0.02	0.51	Sn/Cu
60R065X	0.37	9.4	0.57	14.5	0.20	5.1	0.30	7.6	0.12	3.1	0.047	1.2	0.02	0.51	Sn/Cu
60R075X	0.40	10.2	0.59	15	0.20	5.1	0.30	7.6	0.12	3.1	0.047	1.2	0.02	0.51	Sn/Cu
60R090X	0.44	11.2	0.62	15.8	0.20	5.1	0.30	7.6	0.12	3.1	0.047	1.2	0.02	0.51	Sn/Cu
60R110X	0.51	13	0.72	18.2	0.20	5.1	0.30	7.6	0.12	3.1	0.055	1.4	0.03	0.81	Sn/Cu
60R135X	0.53	13.58	0.78	19.8	0.20	5.1	0.30	7.6	0.12	3.1	0.055	1.4	0.03	0.81	Sn/Cu
60R160X	0.60	15.36	0.85	21.6	0.20	5.1	0.30	7.6	0.12	3.1	0.055	1.4	0.03	0.81	Sn/Cu
60R185X	0.66	16.76	0.91	23	0.20	5.1	0.30	7.6	0.12	3.1	0.055	1.4	0.03	0.81	Sn/Cu
60R250X	0.78	19.93	1.03	26.2	0.40	10.2	0.30	7.6	0.12	3.1	0.055	1.4	0.03	0.81	Sn/Cu
60R300X	0.91	23.11	1.15	29.3	0.40	10.2	0.30	7.6	0.12	3.1	0.055	1.4	0.03	0.81	Sn/Cu
60R375X	1.04	26.3	1.22	31.1	0.40	10.2	0.30	7.6	0.12	3.1	0.055	1.4	0.03	0.81	Sn/Cu

Part Ordering Number System

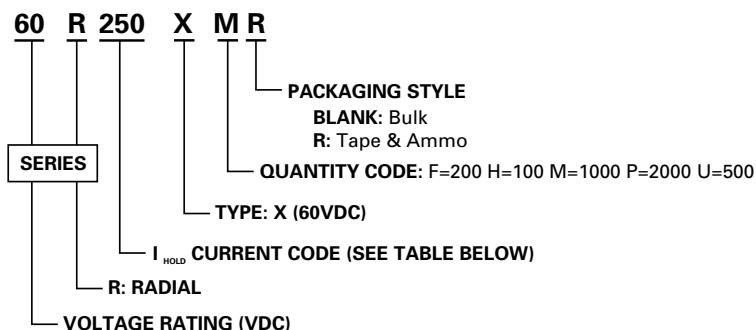

Packaging

Part Number	Ordering Number	I _{hold} (A)	I _{hold} Code	Packaging Option	Quantity	Quantity & Packaging Codes
60R010X	60R010XU	0.10	010	Bulk	500	U
	60R010XPR			Tape and Ammo	2000	PR
60R017X	60R017XU	0.20	020	Bulk	500	U
	60R017XPR			Tape and Ammo	2000	PR
60R020X	60R020XU	0.20	020	Bulk	500	U
	60R020XPR			Tape and Ammo	2000	PR
60R025X	60R025XU	0.25	025	Bulk	500	U
	60R025XPR			Tape and Ammo	2000	PR
60R030X	60R030XU	0.30	030	Bulk	500	U
	60R030XPR			Tape and Ammo	2000	PR
60R040X	60R040XU	0.40	040	Bulk	500	U
	60R040XPR			Tape and Ammo	2000	PR
60R050X	60R050XU	0.50	050	Bulk	500	U
	60R050XPR			Tape and Ammo	2000	PR
60R065X	60R065XU	0.65	065	Bulk	500	U
	60R065XPR			Tape and Ammo	2000	PR
60R075X	60R075XU	0.75	075	Bulk	500	U
	60R075XPR			Tape and Ammo	2000	PR
60R090X	60R090XU	0.90	090	Bulk	500	U
	60R090XPR			Tape and Ammo	2000	PR
60R110X	60R110XU	1.10	110	Bulk	500	U
	60R110XMR			Tape and Ammo	1000	MR
60R135X	60R135XF	1.35	135	Bulk	200	F
	60R135XMR			Tape and Ammo	1000	MR
60R160X	60R160XF	1.60	160	Bulk	200	F
	60R160XMR			Tape and Ammo	1000	MR
60R185X	60R185XF	1.85	185	Bulk	200	F
	60R185XMR			Tape and Ammo	1000	MR
60R250X	60R250XF	2.50	250	Bulk	200	F
	60R250XMR			Tape and Ammo	1000	MR
60R300X	60R300XF	3.00	300	Bulk	200	F
60R375X	60R375XH	3.75	375	Bulk	100	H

Tape and Ammo Specifications

Devices taped using EIA468-B/IE286-2 standards. See table below and Figure 1 for details.

Dimension	EIA Mark	IEC Mark	Dimensions	
			Dim. (mm)	Tol. (mm)
Carrier tape width	W	W	18	-0.5 / +1.0
Hold down tape width	W₄	W₀	11	min.
Top distance between tape edges	W₆	W₂	3	max.
Sprocket hole position	W₅	W₁	9	-0.5 / +0.75
Sprocket hole diameter*	D₀	D₀	4	-0.32 / +0.2
Abscissa to plane(straight lead)	H	H	18.5	-/+ 3.0
Abscissa to plane(kinked lead)	H₀	H₀	16	-/+ 0.5
Abscissa to top 60R010-60R090	H₁	H₁	32.2	max.
Abscissa to top 60R110-60R300	H₁		47.5	max.
Overall width without lead protrusion:60R010-60R090	C₁		42.5	max.
Overall width without lead protrusion:60R110-60R300			57	
Overall width with lead protrusion:60R010-60R090	C2		43.2	max.
Overall width with lead protrusion:60R110-60R300			58	
Lead protrusion	L₁	I₁	1.0	max.
Protrusion of cut out	L	L	11	max.
Protrusion beyond hold-down tape	I₂	I₂	Not specified	
Sprocket hole pitch:60R010-60R090	P₀	P₀	12.7	-/+ 0.3
Sprocket hole pitch:60R110-60R300	P₀	P₀	25.4	-/+ 0.5
Pitch tolerance			20 consecutive.	-/+ 1
Device pitch:60R010-60R090			12.7	
Device pitch:60R110-60R300			25.4	
Tape thickness	t	t	0.9	max.
Tape thickness with splice	t₁		2.0	max.
Splice sprocket hole alignment			0	-/+ 0.3
Body lateral deviation	Δh	Δh	0	-/+ 1.0
Body tape plane deviation	Δp	Δp	0	-/+ 1.3
Ordinate to adjacent component lead*:60R010-60R090	P₁	P₁	3.81	-/+ 0.7
Ordinate to adjacent component lead*:60R110-60R300			7.62	-/+ 0.7
Lead spacing:60R010-60R185	F	F	5.08	-/+ 0.8
Lead spacing:60R250-60R300	F	F	10.18	-/+ 0.8

*Differs from EIA Specification

Tape and Ammo Diagram

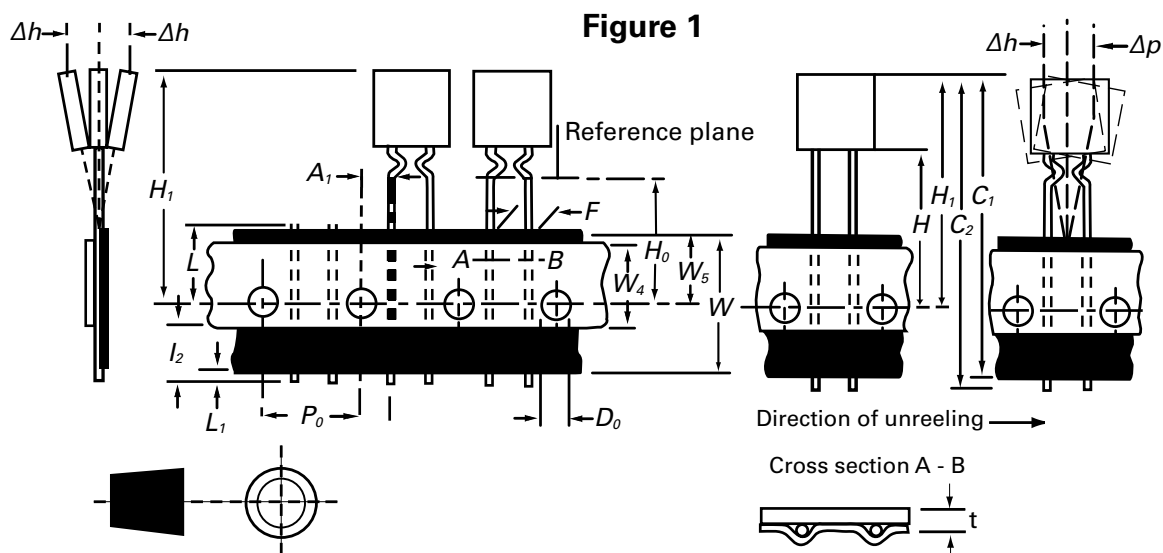

WARNING

- Users shall independently assess the suitability of these devices for each of their applications
- Operation of these devices beyond the stated maximum ratings could result in damage to the devices and lead to electrical arcing and/or fire
- These devices are intended to protect against the effects of temporary over-current or over-temperature conditions and are not intended to perform as protective devices where such conditions are expected to be repetitive or prolonged in duration
- Exposure to silicon-based oils, solvents, electrolytes, acids, and similar materials can adversely affect the performance of these PPTC devices
- These devices undergo thermal expansion under fault conditions, and thus shall be provided with adequate space and be protected against mechanical stresses
- Circuits with inductance may generate a voltage (L di/dt) above the rated voltage of the PPTC device.

Disclaimer Notice - Information furnished is believed to be accurate and reliable. However, users should independently evaluate the suitability of and test each product selected for their own applications. Littelfuse products are not designed for, and may not be used in, all applications. Read complete Disclaimer Notice at www.littelfuse.com/disclaimer-electronics.

72R Series



Description

The 72R Series is designed to provide overcurrent protection to 72Vdc maximum voltage with a maximum 40A short circuit rating.

Features

- 72Vdc max voltage w/max 40A short circuit rating
- RoHS compliant, Lead-Free and Halogen Free*
- Resettable feature
- Ideal for a broad range of general electronics using a low voltage power supply

Applications

- Load protection on wide range of low voltage power supplies
- Computers
- Computer peripherals
- General electronics

Agency Approvals

AGENCY	AGENCY FILE NUMBER
	E183209
	R50119318

Electrical Characteristics

Part Number	I _{hold} (A)	I _{trip} (A)	V _{max} (Vdc)	I _{max} (A)	P _d typ. (W)	Maximum Time To Trip		Resistance		Agency Approvals	
						Current (A)	Time (Sec.)	R _{min} (Ω)	R _{1max} (Ω)		
72R020X	0.20	0.40	72	40	0.41	1.00	2.20	1.830	4.400	X	X
72R025X	0.25	0.50	72	40	0.45	1.25	2.50	1.250	3.000	X	X
72R030X	0.30	0.60	72	40	0.49	1.50	3.00	0.880	2.100	X	X
72R040X	0.40	0.80	72	40	0.56	2.00	3.80	0.550	1.290	X	X
72R050X	0.50	1.00	72	40	0.77	2.50	4.00	0.500	1.170	X	X
72R065X	0.65	1.30	72	40	0.88	3.25	5.30	0.310	0.720	X	X
72R075X	0.75	1.50	72	40	0.92	3.75	6.30	0.250	0.600	X	X
72R090X	0.90	1.80	72	40	0.99	4.50	7.20	0.200	0.470	X	X
72R110X	1.10	2.20	72	40	1.50	5.50	8.20	0.150	0.380	X	X
72R135X	1.35	2.70	72	40	1.70	6.75	9.60	0.120	0.300	X	X
72R160X	1.60	3.20	72	40	1.90	8.00	11.40	0.090	0.220	X	X
72R185X	1.85	3.70	72	40	2.10	9.25	12.60	0.080	0.190	X	X
72R250X	2.50	5.00	72	40	2.50	12.50	15.60	0.050	0.130	X	X
72R300X	3.00	6.00	72	40	2.80	15.00	19.80	0.040	0.100	X	X
72R375X	3.75	7.50	72	40	3.20	18.75	24.00	0.030	0.080	X	X

I_{hold} = Hold current: maximum current device will pass without tripping in 20°C still air.

I_{trip} = Trip current: minimum current at which the device will trip in 20°C still air.

V_{max} = Maximum voltage device can withstand without damage at rated current (I_{max})

I_{max} = Maximum fault current device can withstand without damage at rated voltage (V_{max})

P_d = Power dissipated from device when in the tripped state at 20°C still air.

R_{min} = Minimum resistance of device in initial (un-soldered) state.

R_{1max} = Maximum resistance of device at 20°C measured one hour after tripping or reflow soldering of 260°C for 20 sec.

Caution: Operation beyond the specified rating may result in damage and possible arcing and flame.

* Effective January 1, 2010, all 72R PTC products will be manufactured Halogen Free (HF). Existing Non-Halogen Free 72R PTC products may continue to be sold, until supplies are depleted.

Temperature Derating

Part Number	Ambient Operation Temperature								
	-40°C	-20°C	0°C	20°C	40°C	50°C	60°C	70°C	85°C
72R020X	0.31	0.27	0.24	0.20	0.16	0.14	0.13	0.11	0.08
72R025X	0.39	0.34	0.30	0.25	0.20	0.18	0.16	0.14	0.10
72R030X	0.47	0.41	0.36	0.30	0.24	0.22	0.19	0.16	0.12
72R040X	0.62	0.54	0.48	0.40	0.32	0.29	0.25	0.22	0.16
72R050X	0.78	0.68	0.60	0.50	0.41	0.36	0.32	0.27	0.20
72R065X	1.01	0.88	0.77	0.65	0.53	0.47	0.41	0.35	0.26
72R075X	1.16	1.02	0.89	0.75	0.61	0.54	0.47	0.41	0.30
72R090X	1.40	1.22	1.07	0.90	0.73	0.65	0.57	0.49	0.36
72R110X	1.71	1.50	1.31	1.10	0.89	0.79	0.69	0.59	0.44
72R135X	2.09	1.84	1.61	1.35	1.09	0.97	0.85	0.73	0.54
72R160X	2.48	2.18	1.90	1.60	1.30	1.15	1.01	0.86	0.64
72R185X	2.87	2.52	2.20	1.85	1.50	1.33	1.17	1.00	0.74
72R250X	3.88	3.40	2.98	2.50	2.03	1.80	1.58	1.35	1.00
72R300X	4.65	4.08	3.57	3.00	2.43	2.16	1.89	1.62	1.20
72R375X	5.81	5.10	4.46	3.75	3.04	2.70	2.36	2.03	1.50

Average Time Current Curves

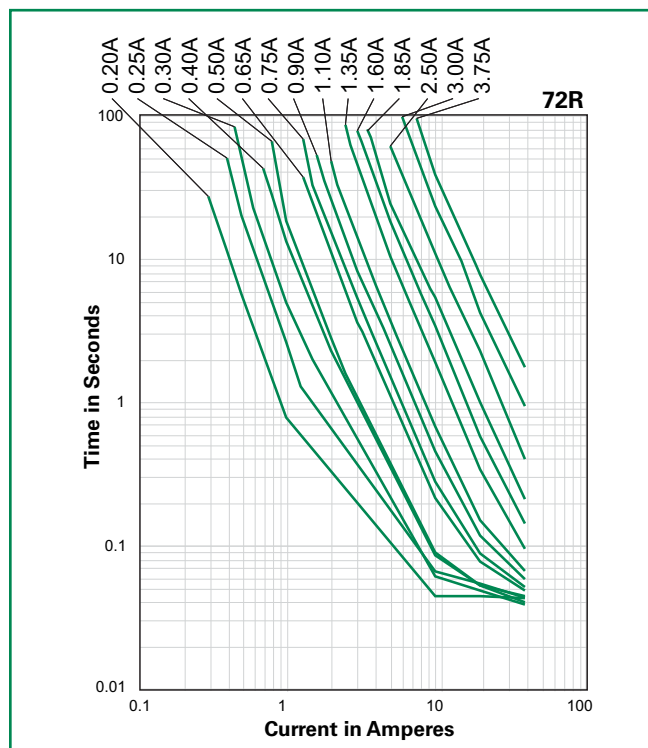

The average time current curves and Temperature Derating curve performance is affected by a number of variables, and these curves provided as guidance only. Customer must verify the performance in their application.

Temperature Derating Curve

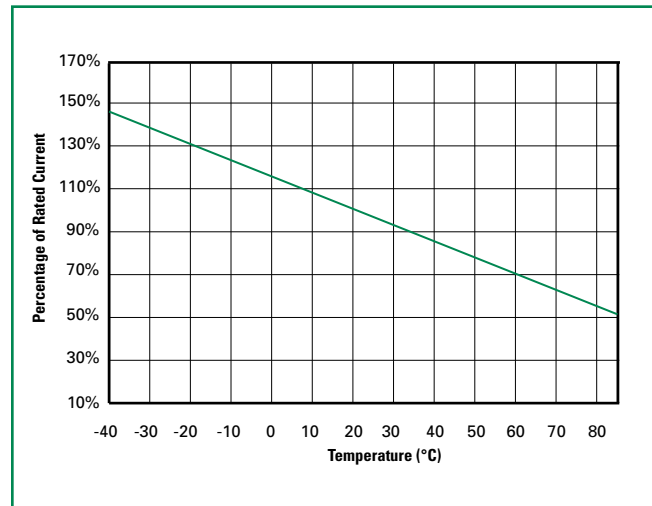

Note:
Typical Temperature derating curve, refer to table for derating data

Soldering Parameters - Wave Soldering

Pre-Heating Zone	Refer to the condition recommended by the flux manufacturer. Max. ramping rate should not exceed 4°C/Sec.
Soldering Zone	Max. solder temperature should not exceed 260°C Time within 5°C of actual Max. solder temperature within 3 - 5 seconds Total time from 25°C room to Max. solder temperature within 5 minutes including Pre-Heating time
Cooling Zone	Cooling by natural convection in air. Max. ramping down rate should not exceed 6°C/Sec.

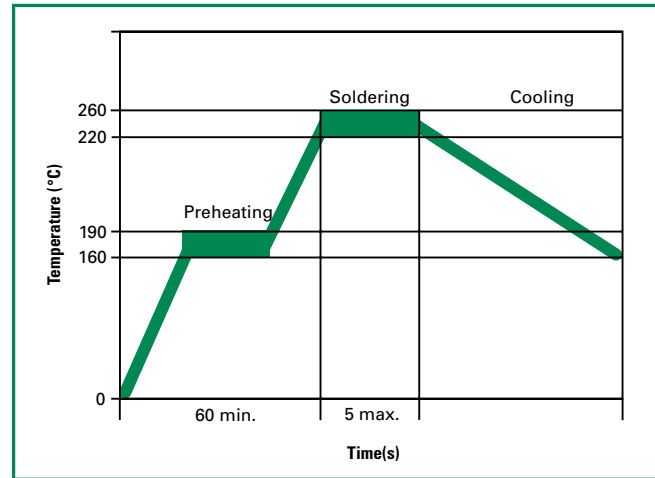

Physical Specifications

Lead Material	0.20-0.40A: Tin-plated Copper clad steel 0.50-3.75A: Tin-plated Copper
Soldering Characteristics	Solderability per MIL-STD-202, Method 208
Insulating Material	Cured, flame retardant epoxy polymer meets UL 94V-0 requirements.
Lead Solderability	Marked with 'LF', voltage, current rating, and date code.

Environmental Specifications

Operating/Storage Temperature	-40°C to +85°C
Maximum Device Surface Temperature in Tripped State	125°C
Passive Aging	+85°C, 1000 hours -/+5% typical resistance change
Humidity Aging	+85°C, 85% R.H. 1000 hours -/+5% typical resistance change
Thermal Shock	+85°C to -40°C 10 times -/+5% typical resistance change
Solvent Resistance	MIL-STD-202, Method 215
Moisture Sensitivity Level	Level 1, J-STD-020

Additional Information



Datasheet



Resources



Samples

Dimensions

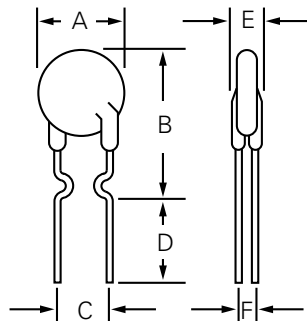

Part Marking System

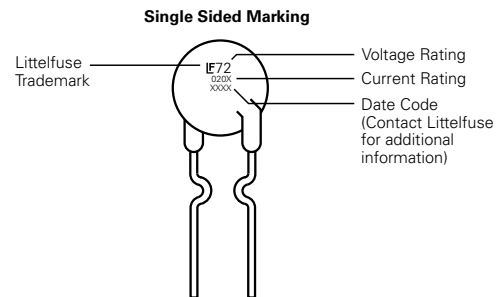

Part Number	A		B		C		D		E		F		Physical Characteristics		
	Inches	mm	Inches	mm	Inches	mm	Inches	mm	Inches	mm	Inches	mm	Lead (dia)		Material
	Max.	Max.	Max.	Max.	Typ.	Typ.	Min.	Min.	Max.	Max.	Typ.	Typ.	Inches	mm	
72R020X	0.29	7.4	0.46	11.7	0.20	5.1	0.30	7.6	0.12	3.1	0.047	1.2	0.02	0.51	Sn/CuFe
72R025X	0.29	7.4	0.50	12.7	0.20	5.1	0.30	7.6	0.12	3.1	0.047	1.2	0.02	0.51	Sn/CuFe
72R030X	0.29	7.4	0.50	12.7	0.20	5.1	0.30	7.6	0.12	3.1	0.047	1.2	0.02	0.51	Sn/CuFe
72R040X	0.30	7.6	0.53	13.5	0.20	5.1	0.30	7.6	0.12	3.1	0.047	1.2	0.02	0.51	Sn/CuFe
72R050X	0.31	7.9	0.54	13.7	0.20	5.1	0.30	7.6	0.12	3.1	0.047	1.2	0.02	0.51	Sn/Cu
72R065X	0.37	9.4	0.57	14.5	0.20	5.1	0.30	7.6	0.12	3.1	0.047	1.2	0.02	0.51	Sn/Cu
72R075X	0.40	10.2	0.60	15.2	0.20	5.1	0.30	7.6	0.12	3.1	0.047	1.2	0.02	0.51	Sn/Cu
72R090X	0.44	11.2	0.62	15.8	0.20	5.1	0.30	7.6	0.12	3.1	0.047	1.2	0.02	0.51	Sn/Cu
72R110X	0.51	13.0	0.72	18.2	0.20	5.1	0.30	7.6	0.12	3.1	0.055	1.4	0.03	0.81	Sn/Cu
72R135X	0.53	13.58	0.78	19.8	0.20	5.1	0.30	7.6	0.12	3.1	0.055	1.4	0.03	0.81	Sn/Cu
72R160X	0.60	15.36	0.85	21.6	0.20	5.1	0.30	7.6	0.12	3.1	0.055	1.4	0.03	0.81	Sn/Cu
72R185X	0.66	16.76	0.91	23.0	0.20	5.1	0.30	7.6	0.12	3.1	0.055	1.4	0.03	0.81	Sn/Cu
72R250X	0.78	19.93	1.03	26.2	0.40	10.2	0.30	7.6	0.12	3.1	0.055	1.4	0.03	0.81	Sn/Cu
72R300X	0.91	23.11	1.15	29.3	0.40	10.2	0.30	7.6	0.12	3.1	0.055	1.4	0.03	0.81	Sn/Cu
72R375X	1.04	26.3	1.22	31.1	0.40	10.2	0.30	7.6	0.12	3.1	0.055	1.4	0.03	0.81	Sn/Cu

Part Ordering Number System

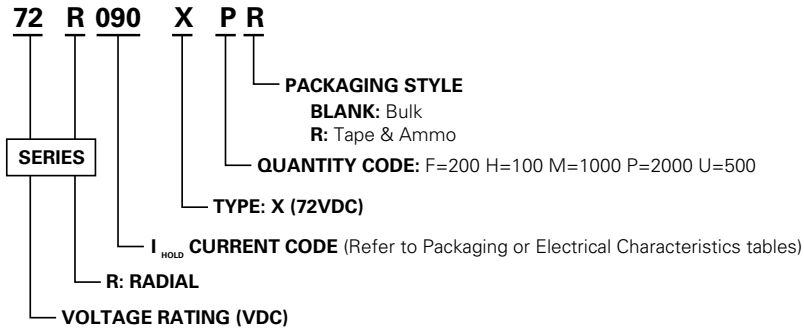

Packaging

Part Number	Ordering Part Number	I_{hold} (A)	I_{hold} Code	Packaging Option	Quantity	Quantity & Packaging Codes
72R020X	72R020XU	0.20	020	Bulk	500	U
	72R020XPR			Tape and Ammo	2000	PR
72R025X	72R025XU	0.25	025	Bulk	500	U
	72R025XPR			Tape and Ammo	2000	PR
72R030X	72R030XU	0.30	030	Bulk	500	U
	72R030XPR			Tape and Ammo	2000	PR
72R040X	72R040XU	0.40	040	Bulk	500	U
	72R040XPR			Tape and Ammo	2000	PR
72R050X	72R050XU	0.50	050	Bulk	500	U
	72R050XPR			Tape and Ammo	2000	PR
72R065X	72R065XU	0.65	065	Bulk	500	U
	72R065XPR			Tape and Ammo	2000	PR
72R075X	72R075XU	0.75	075	Bulk	500	U
	72R075XPR			Tape and Ammo	2000	PR
72R090X	72R090XU	0.90	090	Bulk	500	U
	72R090XPR			Tape and Ammo	2000	PR
72R110X	72R110XU	1.10	110	Bulk	500	U
	72R110XMR			Tape and Ammo	1000	MR
72R135X	72R135XF	1.35	135	Bulk	200	F
	72R135XMR			Tape and Ammo	1000	MR
72R160X	72R160XF	1.60	160	Bulk	200	F
	72R160XMR			Tape and Ammo	1000	MR
72R185X	72R185XF	1.85	185	Bulk	200	F
	72R185XMR			Tape and Ammo	1000	MR
72R250X	72R250XF	2.50	250	Bulk	200	F
	72R250XMR			Tape and Ammo	1000	MR
72R300X	72R300XF	3.00	300	Bulk	200	F
	72R300XMR			Tape and Ammo	1000	MR
72R375X	72R375XH	3.75	375	Bulk	100	H

Tape and Ammo Specifications

Devices taped using EIA468-B/IE286-2 standards. See table below and Figure 1 for details.

Dimension	EIA Mark	IEC Mark	Dimensions	
			Dim. (mm)	Tol. (mm)
Carrier tape width	W	W	18	-0.5 / +1.0
Hold down tape width	W₄	W₀	11	min.
Top distance between tape edges	W₆	W₂	3	max.
Sprocket hole position	W₅	W₁	9	-0.5 / +0.75
Sprocket hole diameter*	D₀	D₀	4	-0.32 / +0.2
Abscissa to plane (straight lead)	H	H	18.5	-/+ 3.0
Abscissa to plane (kinked lead)	H₀	H₀	16	-/+ 0.5
Abscissa to top 72R020X-72R090X	H₁	H₁	32.2	max.
Abscissa to top 72R110X-72R300X	H₁		47.5	max.
Overall width without lead protrusion: 72R020X-72R090X	C₁		42.5	max.
Overall width without lead protrusion: 72R110X-72R300X			57	
Overall width with lead protrusion: 72R020X-72R090X	C₂		43.2	max.
Overall width with lead protrusion: 72R110X-72R300X		58		
Lead protrusion	L₁	I₁	1.0	max.
Protrusion of cut out	L	L	11	max.
Protrusion beyond hold-down tape	I₂	I₂	Not specified	
Sprocket hole pitch: 72R020X-72R090X	P₀	P₀	12.7	-/+ 0.3
Sprocket hole pitch: 72R110X-72R300X	P₀	P₀	25.4	-/+ 0.5
Pitch tolerance			20 consecutive.	-/+ 1
Device pitch: 72R020X-72R090X			12.7	
Device pitch: 72R110X-72R300X			25.4	
Tape thickness	t	t	0.9	max.
Tape thickness with splice	t₁		2.0	max.
Splice sprocket hole alignment			0	-/+ 0.3
Body lateral deviation	Δh	Δh	0	-/+ 1.0
Body tape plane deviation	Δp	Δp	0	-/+ 1.3
Ordinate to adjacent component lead*: 72R020X-72R090X	P₁	P₁	3.81	-/+ 0.7
Ordinate to adjacent component lead*: 72R110X-72R300X			7.62	-/+ 0.7
Lead spacing: 72R020X-72R185X	F	F	5.08	-/+ 0.8
Lead spacing: 72R250X-72R300X	F	F	10.18	-/+ 0.8

*Differs from EIA Specification

Tape and Ammo Diagram

Figure 1

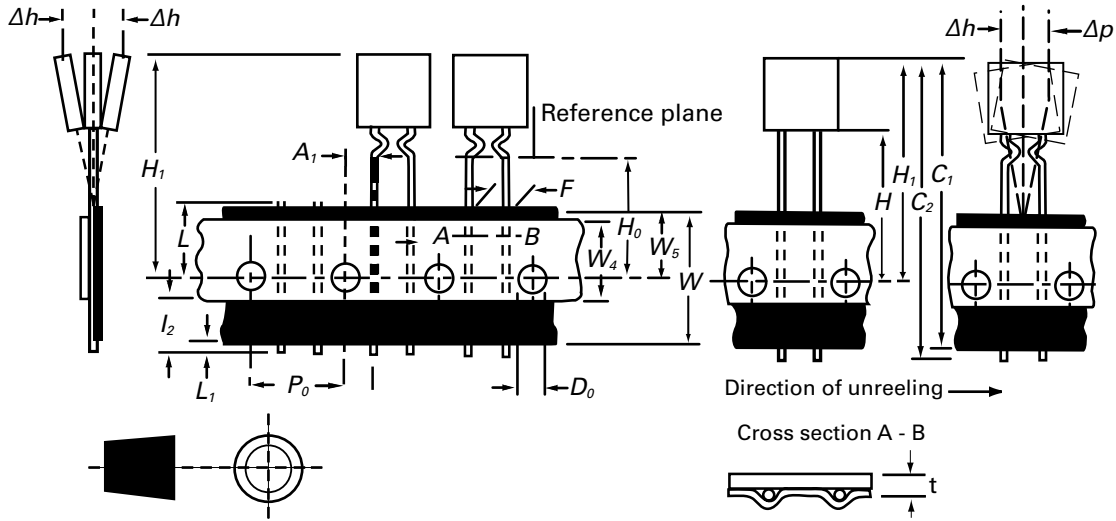

WARNING

- Users shall independently assess the suitability of these devices for each of their applications
- Operation of these devices beyond the stated maximum ratings could result in damage to the devices and lead to electrical arcing and/or fire
- These devices are intended to protect against the effects of temporary over-current or over-temperature conditions and are not intended to perform as protective devices where such conditions are expected to be repetitive or prolonged in duration
- Exposure to silicon-based oils, solvents, electrolytes, acids, and similar materials can adversely affect the performance of these PPTC devices
- These devices undergo thermal expansion under fault conditions, and thus shall be provided with adequate space and be protected against mechanical stresses
- Circuits with inductance may generate a voltage (L di/dt) above the rated voltage of the PPTC device.

Disclaimer Notice - Information furnished is believed to be accurate and reliable. However, users should independently evaluate the suitability of and test each product selected for their own applications. Littelfuse products are not designed for, and may not be used in, all applications. Read complete Disclaimer Notice at www.littelfuse.com/disclaimer-electronics.

135R Series

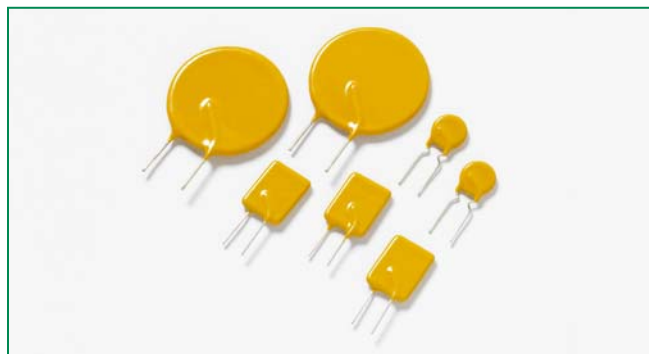

Description

The 135R Series is designed to protect against short duration high voltage fault currents (power cross or power induction surge) typically found in telecom applications (265Vrms). The series can be used to help telecom networking equipment meet the protection requirements specified in ITU K.20 and K.21.



Features

- Designed for line voltage applications.
- Protection against both overcurrent and overtemperature
- Fast time-to-trip
- .05–2.0 hold current range
- 135VAC interrupt rating
- Binned and sorted narrow resistance ranges available
- RoHS compliant, Lead-Free and Halogen-Free*



Applications

- Customer Premises Equipment (CPE)
- Central Office (CO)/telecom centers
- LAN/WAN equipment
- Access equipment

Agency Approvals



AGENCY	AGENCY FILE NUMBER
	PENDING
	PENDING

Electrical Characteristics

Part Number	I _{hold} (A)	I _{trip} (A)	V _{max} (V _{int})	I _{max} (A)	Maximum Time To Trip		Resistance			Agency Approvals	
					Current (A)	Time (Sec.)	R _{min} (Ω)	R _{typ} (Ω)	R _{1max} (Ω)		
135R050	0.05	0.12	135	1.0	0.25	10.0	18.50	31.00	65.00	Pending	
135R080	0.08	0.19	135	1.2	0.40	10.0	7.40	12.00	26.00		
135R100	0.10	0.20	135	2.0	0.50	3.6	5.60	10.00	20.10		
135R120	0.12	0.30	135	1.2	0.60	15.0	3.00	6.50	12.00		
135R150	0.15	0.30	135	2.0	0.75	3.2	2.30	6.50	10.70		
135R160	0.16	0.37	135	2.0	0.80	15.0	2.50	4.10	7.80		
135R170	0.17	0.34	135	2.0	0.85	10.0	2.00	7.00	10.80		
135R200	0.20	0.40	135	2.0	1.00	3.0	1.70	3.40	6.10		
135R250	0.25	0.50	135	3.0	1.25	8.0	1.25	1.65	3.45		
135R300	0.30	0.60	135	3.0	1.50	5.8	0.90	1.55	2.95		
135R330	0.33	0.74	135	4.5	1.65	21.0	0.77	1.24	2.60		
135R350	0.35	0.70	135	3.0	1.75	7.0	0.85	1.20	2.45		
135R400	0.40	0.80	135	3.0	2.00	5.0	0.72	1.25	2.36		
135R500	0.50	1.00	135	3.0	2.50	5.3	0.55	0.85	1.68		
135R550	0.55	1.25	135	7.0	2.75	26.0	0.45	0.73	1.45		
135R650	0.65	1.30	135	5.0	3.25	6.5	0.40	0.65	1.26		
135R700	0.70	1.50	135	5.0	3.75	6.3	0.25	0.60	1.05		
135R750	0.75	1.50	135	7.5	3.75	14.0	0.25	0.40	0.69		
135R800	0.80	1.60	135	5.0	4.00	7.0	0.30	0.59	0.93		
135R900	0.90	1.80	135	5.0	4.50	7.2	0.20	0.47	0.70		
135R1000	1.00	1.00	135	10.0	5.00	13.6	0.18	0.27	0.47		
135R1100	1.10	2.20	135	8.0	5.50	7.3	0.15	0.50	0.68		
135R1250	1.25	2.50	135	12.5	6.25	18.0	0.12	0.18	0.32		

List Continues on Next Page

Electrical Characteristics (continued)

Part Number	I _{hold} (A)	I _{trip} (A)	V _{max} (V _{int})	I _{max} (A)	Maximum Time To Trip		Resistance			Agency Approvals	
					Current (A)	Time (Sec.)	R _{min} (Ω)	R _{typ} (Ω)	R _{1max} (Ω)		
135R1300	1.30	2.70	135	10.0	6.75	9.6	0.12	0.30	0.44	Pending	
135R1350	1.35	2.70	135	13.5	6.75	7.5	0.11	0.38	0.52		
135R1600	1.60	3.20	135	12.0	8.00	11.4	0.09	0.22	0.33		
135R1850	1.85	3.70	135	12.0	9.25	12.6	0.08	0.19	0.29		
135R2000	2.00	4.20	135	20.0	10.00	36.0	0.08	0.12	0.21		
135R2500	2.50	5.00	135	15.0	12.50	15.6	0.05	0.13	0.19		
135R3000	3.00	6.00	135	17.0	15.00	19.8	0.04	0.10	0.15		
135R3750	3.75	7.50	135	20.0	18.75	24.0	0.03	0.08	0.12		

I_{hold} = Hold current: maximum current device will pass without tripping in 25°C still air.
 I_{trip} = Trip current: minimum current at which the device will trip in 25°C still air.
 V_{int} = Maximum voltage the device can withstand without damage at rated current (I_{max})
 V_{op} = The device regular operation voltage
 I_{max} = Maximum fault current device can withstand without damage at rated voltage (V_{max})

P_d = Power dissipated from device when in the tripped state at 25°C still air.
 R_{min} = Minimum resistance of device in initial (un-soldered) state.
 R_{typ} = Typical resistance of device in initial (un-soldered) state.
 R_{1max} = Maximum resistance of device at 25°C measured one hour after tripping.
Caution: Operation beyond specified rating may result in damage, possible arcing and fire.

Average Time Current Curves

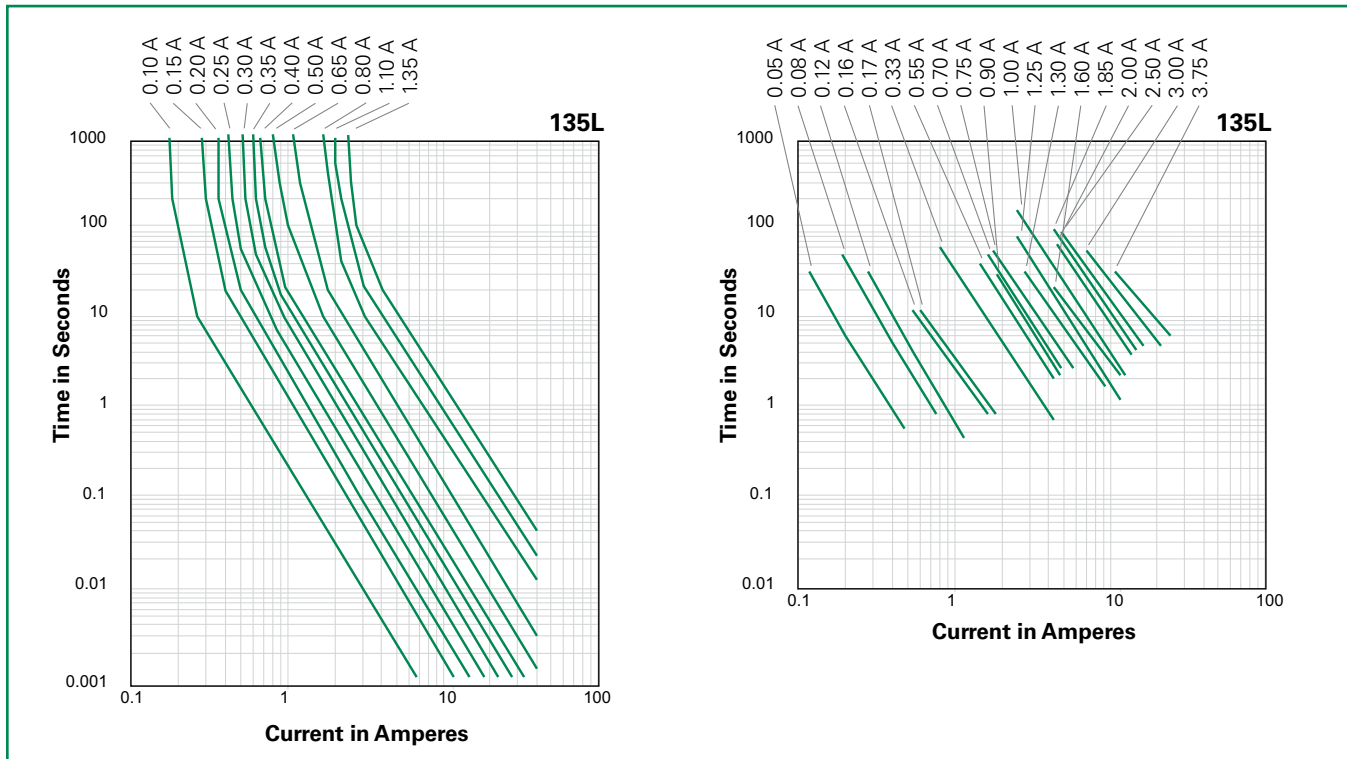

The average time current curves and Temperature Rerating curve performance is affected by a number of variables, and these curves provided as guidance only. Customer must verify the performance in their application.

Temperature Derating

Part Number	Ambient Operation Temperature								
	-40°C	-20°C	0°C	20°C	40°C	50°C	60°C	70°C	85°C
	Hold Current (A)								
135R050	0.08	0.07	0.06	0.05	0.04	0.03	0.03	0.02	0.02
135R080	0.13	0.12	0.10	0.08	0.06	0.05	0.05	0.04	0.03
135R100	0.23	0.19	0.15	0.10	0.08	0.06	0.05	0.04	0.02
135R120	0.25	0.18	0.15	0.12	0.10	0.09	0.07	0.06	0.04
135R150	0.28	0.24	0.20	0.15	0.13	0.11	0.09	0.07	0.05
135R160	0.30	0.25	0.21	0.16	0.14	0.12	0.10	0.08	0.06
135R170	0.31	0.26	0.22	0.17	0.15	0.13	0.11	0.09	0.07
135R200	0.33	0.29	0.25	0.20	0.18	0.16	0.14	0.12	0.10
135R250	0.38	0.34	0.30	0.25	0.22	0.20	0.18	0.16	0.14
135R300	0.43	0.39	0.35	0.30	0.27	0.25	0.23	0.21	0.18
135R330	0.58	0.50	0.42	0.33	0.27	0.23	0.20	0.17	0.11
135R350	0.48	0.44	0.40	0.35	0.32	0.30	0.28	0.26	0.23
135R400	0.53	0.49	0.45	0.40	0.37	0.35	0.33	0.31	0.28
135R500	0.63	0.59	0.55	0.50	0.47	0.45	0.43	0.41	0.38
135R550	0.91	0.80	0.69	0.55	0.45	0.39	0.34	0.28	0.21
135R650	0.78	0.74	0.70	0.65	0.62	0.60	0.58	0.56	0.53
135R700	1.42	1.21	0.96	0.70	0.63	0.56	0.50	0.43	0.34
135R750	1.45	1.24	0.99	0.75	0.65	0.58	0.52	0.45	0.36
135R800	0.93	0.89	0.85	0.80	0.77	0.75	0.73	0.71	0.68
135R900	1.48	1.23	1.12	0.90	0.72	0.64	0.56	0.50	0.37
135R1000	1.60	1.42	1.23	1.00	0.78	0.69	0.61	0.54	0.42
135R1100	1.23	1.19	1.15	1.10	1.07	1.05	1.03	1.01	0.98
135R1250	2.03	1.81	1.58	1.25	1.08	0.98	0.86	0.75	0.63
135R1300	2.06	1.84	1.62	1.30	1.11	1.00	0.89	0.77	0.64
135R1350	1.48	1.44	1.40	1.35	1.32	1.30	1.28	1.26	1.23
135R1600	2.34	2.12	1.91	1.60	1.40	1.29	1.29	1.08	0.94
135R1850	2.60	2.38	2.16	1.85	1.56	1.46	1.46	1.23	1.09
135R2000	2.76	2.54	2.32	2.00	1.71	1.60	1.49	1.39	1.25
135R2500	3.27	3.05	2.83	2.50	2.22	2.11	1.99	1.87	1.73
135R3000	3.75	3.53	3.32	3.00	2.69	2.58	2.49	2.38	2.24
135R3750	4.51	4.29	4.07	3.75	3.45	3.34	3.24	3.12	2.98

WARNING

- Users shall independently assess the suitability of these devices for each of their applications
- Operation of these devices beyond the stated maximum ratings could result in damage to the devices and lead to electrical arcing and/or fire
- These devices are intended to protect against the effects of temporary over-current or over-temperature conditions and are not intended to perform as protective devices where such conditions are expected to be repetitive or prolonged in duration
- Exposure to silicon-based oils, solvents, electrolytes, acids, and similar materials can adversely affect the performance of these PPTC devices
- These devices undergo thermal expansion under fault conditions, and thus shall be provided with adequate space and be protected against mechanical stresses
- Circuits with inductance may generate a voltage ($L di/dt$) above the rated voltage of the PPTC device.

Soldering Parameters - Wave Soldering

Condition	Wave Soldering
Peak Temp/ DurationTime	260°C ≤ 5 Sec
≥ 220°C	2 Sec ~ 20 Sec
Preheat 140°C ~ 180°C	180 Sec ~ 210 Sec
Storage Condition	0°C~35°C ≤ 70%RH

- Recommended soldering methods: heat element oven or N₂ environment for lead-free.
- Devices are designed to be wave soldered to the bottom side of the board.
- Devices can be cleaned using standard industry methods and solvents.
- This profile can be used for lead-free device

Note: If soldering temperatures exceed the recommended profile, devices may not meet the performance requirements.

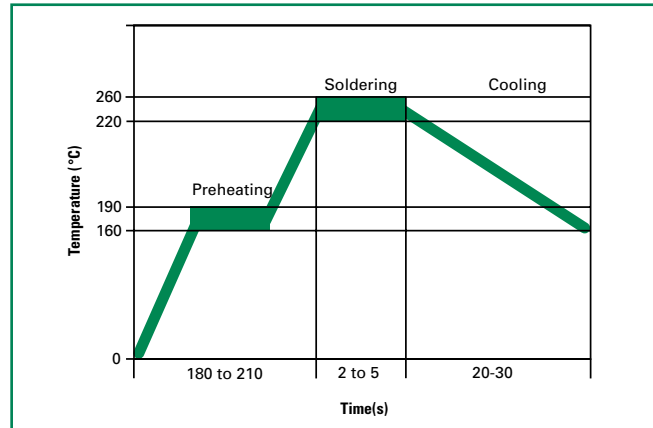

Physical Specifications

Lead Material	Tin-plated Copper
Soldering Characteristics	Solderability per MIL-STD-202, Method 208E
Insulating Material	Cured, flame retardant epoxy polymer meets UL94V-0 requirements.
Device Labeling	Marked with 'LF', voltage, current rating, and date code.

Environmental Specifications

Operating/Storage Temperature	-40°C to +85°C
Maximum Device Surface Temperature in Tripped State	125°C
Passive Aging	65°C/85°C, 1000 hours
Humidity Aging	+85°C, 85% R.H., 1000 hours
Thermal Shock	MIL-STD-202, Method 107 +125°C to -55°C 10 times
Solvent Resistance	MIL-STD-202, Method 215
Moisture Sensitivity Level	Level 1, J-STD-020C

Dimensions

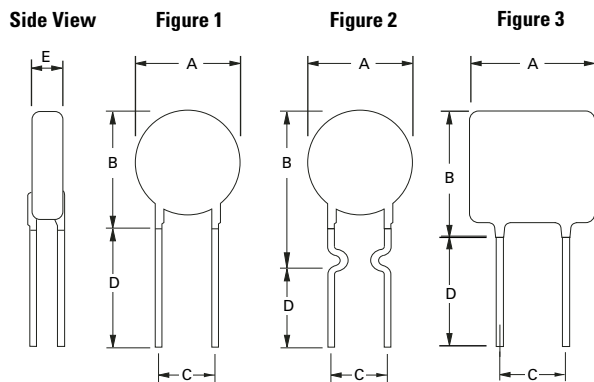

Part Marking System

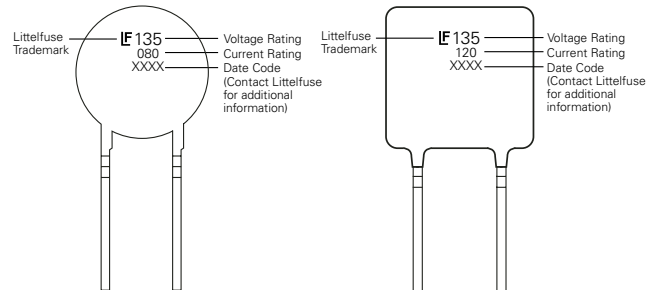

Part Number	Figure	A		B		C		D		E		Physical Characteristics		
		Inches	mm	Inches	mm	Inches	mm	Inches	mm	Inches	mm	Lead (dia)		Material
		Max.	Max.	Max.	Max.	Typ.	Typ.	Min.	Min.	Max.	Max.	Inches	mm	
135R050	2	0.272	6.9	0.390	9.9	0.201	5.1	0.299	7.6	0.181	4.6	0.020	0.5	Sn/Cu
135R080	2	0.283	7.2	0.402	10.2	0.201	5.1	0.299	7.6	0.181	4.6	0.020	0.5	Sn/Cu
135R100	1	0.217	5.5	0.402	10.2	0.201	5.1	0.299	7.6	0.122	3.1	0.024	0.6	Sn/Cu
135R120	2	0.327	8.3	0.421	10.7	0.201	5.1	0.299	7.6	0.150	3.8	0.020	0.5	Sn/Cu
135R150	1	0.236	6	0.449	11.4	0.201	5.1	0.299	7.6	0.122	3.1	0.024	0.6	Sn/Cu
135R160	2	0.390	9.9	0.492	12.5	0.201	5.1	0.299	7.6	0.150	3.8	0.020	0.5	Sn/Cu
135R170	1	0.311	7.9	0.512	13	0.201	5.1	0.299	7.6	0.150	3.8	0.020	0.5	Sn/Cu
135R200	1	0.256	6.5	0.457	11.6	0.201	5.1	0.299	7.6	0.122	3.1	0.024	0.6	Sn/Cu
135R250	1	0.307	7.8	0.492	12.5	0.201	5.1	0.299	7.6	0.122	3.1	0.024	0.6	Sn/Cu
135R300	1	0.335	8.5	0.492	12.5	0.201	5.1	0.299	7.6	0.122	3.1	0.024	0.6	Sn/Cu
135R330	2	0.449	11.4	0.650	16.5	0.201	5.1	0.299	7.6	0.150	3.8	0.024	0.6	Sn/Cu
135R350	1	0.343	8.7	0.512	13	0.201	5.1	0.299	7.6	0.122	3.1	0.024	0.6	Sn/Cu
135R400	1	0.374	9.5	0.571	14.5	0.201	5.1	0.299	7.6	0.122	3.1	0.024	0.6	Sn/Cu
135R500	1	0.406	10.3	0.650	16.5	0.201	5.1	0.299	7.6	0.122	3.1	0.024	0.6	Sn/Cu
135R550	3	0.551	14	0.854	21.7	0.201	5.1	0.299	7.6	0.161	4.1	0.031	0.8	Sn/Cu
135R650	1	0.472	12	0.689	17.5	0.201	5.1	0.299	7.6	0.122	3.1	0.024	0.6	Sn/Cu
135R700	1	0.417	10.6	0.610	15.5	0.201	5.1	0.299	7.6	0.150	3.8	0.024	0.6	Sn/Cu
135R750	3	0.429	10.9	0.669	17	0.201	5.1	0.299	7.6	0.161	4.1	0.031	0.8	Sn/Cu
135R800	1	0.551	14	0.693	17.6	0.201	5.1	0.299	7.6	0.122	3.1	0.024	0.6	Sn/Cu
135R900	1	0.469	11.9	0.626	15.9	0.201	5.1	0.299	7.6	0.150	3.8	0.024	0.6	Sn/Cu
135R1000	3	0.453	11.5	0.791	20.1	0.201	5.1	0.299	7.6	0.161	4.1	0.031	0.8	Sn/Cu
135R1100	1	0.547	13.9	0.776	19.7	0.201	5.1	0.299	7.6	0.122	3.1	0.024	0.6	Sn/Cu
135R1250	3	0.551	14	0.854	21.7	0.201	5.1	0.299	7.6	0.161	4.1	0.031	0.8	Sn/Cu
135R1300	2	0.610	15.5	0.811	20.6	0.201	5.1	0.299	7.6	0.161	4.1	0.024	0.6	Sn/Cu
135R1350	1	0.634	16.1	0.862	21.9	0.201	5.1	0.299	7.6	0.122	3.1	0.031	0.8	Sn/Cu
135R1600	2	0.693	17.6	0.886	22.5	0.201	5.1	0.299	7.6	0.161	4.1	0.031	0.8	Sn/Cu
135R1850	2	0.783	19.9	0.980	24.9	0.201	5.1	0.299	7.6	0.161	4.1	0.031	0.8	Sn/Cu
135R2000	3	0.925	23.5	1.252	31.8	0.402	10.2	0.299	7.6	0.161	4.1	0.031	0.8	Sn/Cu
135R2500	2	0.886	22.5	1.083	27.5	0.402	10.2	0.299	7.6	0.161	4.1	0.031	0.8	Sn/Cu
135R3000	2	1.004	25.5	1.181	30	0.402	10.2	0.299	7.6	0.161	4.1	0.031	0.8	Sn/Cu
135R3750	2	1.161	29.5	1.339	34	0.402	10.2	0.299	7.6	0.161	4.1	0.031	0.8	Sn/Cu

Part Ordering Number System

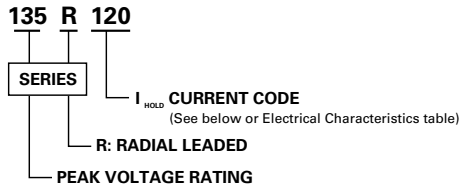

Product is supplied bulk; Please refer to Packaging section for quantity information.
For additional packaging options please contact Littelfuse.

Packaging



Ordering Number	I _{hold} (A)	I _{hold} Code	Packaging Option	Quantity
135R050	0.05	005	Bulk	1000
135R080	0.08	008		
135R100	0.10	010		
135R120	0.12	012		
135R150	0.15	015		
135R160	0.16	016		
135R170	0.17	017		
135R200	0.20	020		
135R250	0.25	025		
135R300	0.30	030		
135R330	0.33	033		
135R350	0.35	035		
135R400	0.40	040		
135R500	0.50	050		
135R550	0.55	055		
135R650	0.65	065		
135R700	0.70	070		
135R750	0.75	075		
135R800	0.80	080		
135R900	0.90	090		
135R1000	1.00	100	500	
135R1100	1.10	110		
135R1250	1.25	125		
135R1300	1.30	130		
135R1350	1.35	135		
135R1600	1.60	160		
135R1850	1.85	185		
135R2000	2.00	200		
135R2500	2.50	250		
135R3000	3.00	300		
135R3750	3.75	375		

Disclaimer Notice - Information furnished is believed to be accurate and reliable. However, users should independently evaluate the suitability of and test each product selected for their own applications. Littelfuse products are not designed for, and may not be used in, all applications. Read complete Disclaimer Notice at www.littelfuse.com/disclaimer-electronics.

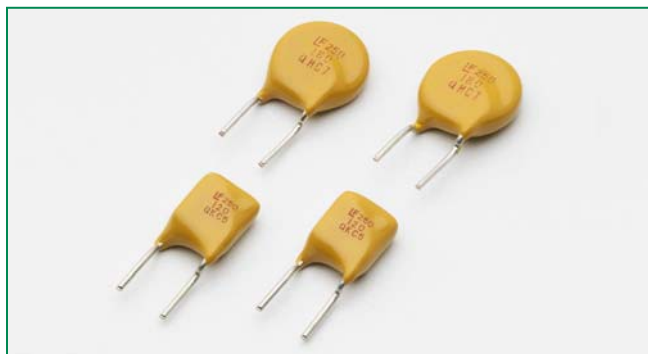
250R Series



Agency Approvals

AGENCY	AGENCY FILE NUMBER
	E183209
	R50120008

Description

The 250R Series is designed to protect against short duration high voltage fault currents (power cross or power induction surge) typically found in telecom applications (250Vrms). The series can be used to help telecom networking equipment meet the protection requirements specified in ITU K.20 and K.21.



Features

- 0.08 – 0.18 hold current range, 60VDC operating voltage
- 250VAC interrupt rating
- Fast time-to-trip
- Binned and sorted narrow resistance ranges available
- RoHS compliant, Lead-Free and Halogen-Free*

Applications

- Customer Premises Equipment (CPE)
- Central Office (CO)/telecom centers
- LAN/WAN equipment
- Access equipment

Electrical Characteristics

Part Number	I _{hold} (A)	I _{trip} (A)	V _{max} V _{int} / V _{op}	I _{max} (A)	P _d typ. (W)	Maximum Time To Trip		Resistance			Agency Approvals	
						Current (A)	Time (Sec.)	R _{min} (Ω)	R _{typ} (Ω)	R _{1max} (Ω)		
250R080	0.08	0.16	250/60	3	1	0.35	4.0	14	22	33	X	X
250R080T	0.08	0.16	250/60	3	1	0.35	4.0	15	22	33	X	X
250R120	0.12	0.24	250/60	3	1	1	2.5	4	8	16	X	X
250R120-RA	0.12	0.24	250/60	3	1	1	2.5	7	9	16	X	X
250R120-RC	0.12	0.24	250/60	3	1	1	3.0	5.4	7.5	14	X	X
250R120-RF	0.12	0.24	250/60	3	1	1	2.5	6	10.5	16	X	X
250R120-R1	0.12	0.24	250/60	3	1	1	2.5	6	9	16	X	X
250R120-R2	0.12	0.24	250/60	3	1	1	2.5	8	10.5	16	X	X
250R120-R3	0.12	0.24	250/60	3	1	1	2.5	8	10	16	X	X
250R120T	0.12	0.24	250/60	3	1	1	2.5	7	12	16	X	X
250R145	0.145	0.29	250/60	3	1	1	2.5	3	6	14	X	X
250R145-RA	0.145	0.29	250/60	3	1	1	2.5	3	5.5	12	X	X
250R145-RB	0.145	0.29	250/60	3	1	1	2.5	4.5	6	14	X	X
250R145T	0.145	0.29	250/60	3	1	1	2.5	5.4	7.5	14	X	X
250R180	0.18	0.65	250/60	10	1.8	1	20	0.8	2.2	4	X	X
250R180T	0.18	0.65	250/60	10	1.8	1	21	1.4	3.9	4.5	X	X

Items with T at end of part number = pre-tripped device. See Part Ordering Number System section of this data sheet for additional information.

I_{hold} = Hold current: maximum current device will pass without tripping in 20°C still air.
 I_{trip} = Trip current: minimum current at which the device will trip in 20°C still air.
 V_{max} = Maximum voltage the device can withstand without damage at rated current (I_{max})
 V_{op} = The device regular operation voltage
 I_{max} = Maximum fault current device can withstand without damage at rated voltage (V_{max})
 P_d = Power dissipated from device when in the tripped state at 20°C still air.

R_{min} = Minimum resistance of device in initial (un-soldered) state.
 R_{typ} = Typical resistance of device in initial (un-soldered) state.
 R_{1max} = Maximum resistance of device at 20°C measured one hour after tripping.

Caution: Operation beyond the specified rating may result in damage and possible arcing and flame.

* Effective January 1, 2010, all 250R PTC products will be manufactured Halogen Free (HF). Existing Non-Halogen Free 250R PTC products may continue to be sold, until supplies are depleted.

Temperature Rating

Part Number	Ambient Operation Temperature								
	-40°C	-20°C	0°C	20°C	40°C	50°C	60°C	70°C	85°C
	Hold Current (A)								
250R080	0.12	0.11	0.09	0.08	0.06	0.05	0.05	0.04	0.03
250R080T	0.12	0.11	0.09	0.08	0.06	0.05	0.05	0.04	0.03
250R120	0.18	0.16	0.14	0.12	0.10	0.09	0.08	0.06	0.05
250R120T	0.18	0.16	0.14	0.12	0.10	0.09	0.08	0.06	0.05
250R145	0.26	0.20	0.17	0.145	0.12	0.11	0.09	0.08	0.06
250R145T	0.26	0.20	0.17	0.145	0.12	0.11	0.09	0.08	0.06
250R180	0.28	0.23	0.21	0.18	0.16	0.13	0.10	0.11	0.083
250R180T	0.28	0.23	0.21	0.18	0.16	0.13	0.10	0.11	0.083

Average Time Current Curves

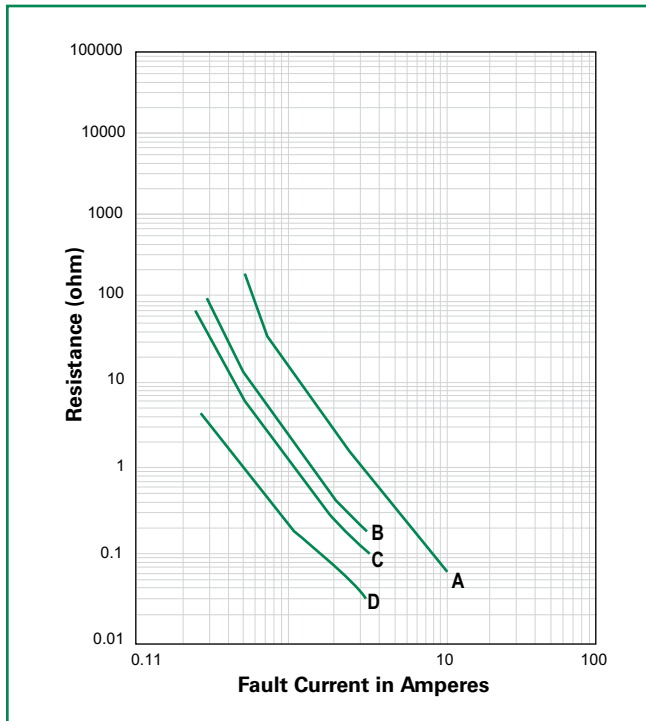

The average time current curves and Temperature Rating curve performance is affected by a number of variables, and these curves provided as guidance only. Customer must verify the performance in their application.

Curve Designation	I_{hold} (A)
A	0.18
B	0.145
C	0.12
D	0.080

Temperature Rating Curve

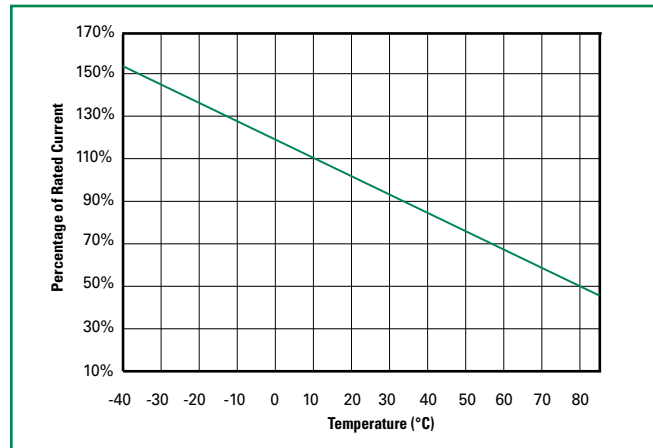

Note:
Typical Temperature rating curve, refer to table for derating data

Additional Information



Datasheet



Resources



Samples

Agency Specification Selection Guide For Telecom and Networking Applications

Product	Lightning	Power Cross
250R120	ITU K.20/21/45 – 1.5kV 10/700µs	ITU K.20/21/45 – 230Vac, 10Ω
250R145	ITU K.20/21/45 – 4kV 10/700µs*	ITU K.20/21/45 – 600Vac, 600Ω
250R180	ITU K.20/21/45 – 1.5kV 10/700µs ITU K.20/21/45 – 4kV 10/700µs* Telcordia GR – 974 – 1.0kV 10/1000µs	ITU K.20/21/45 – 230Vac, 10Ω ITU K.20/21/45 – 600Vac, 600Ω Telcordia GR – 974- 283Vac, 10A

*Devices should be independently evaluated and tested for use in any specific application

Protection Application Guide

Region/Specification	Application	Device Selection
South America/Asia/Europe ITU K.45	*Access network equipment Remote terminal Repeaters WAN equipment Cross –connect	250R180 250R180T 250R145 250R145T 250R120 250R120T
South America/Asia/Europe ITU K.21	Customer and IT equipment Analog modems ADSL, xDSL Phone sets, PBX systems Internet appliances POS terminals	250R180 250R180T 250R145 250R145T 250R120 250R120T
South America/Asia/Europe ITU K.20	Central Office POTS/ISDN linecards T1/E1/J1 linecards ADSL/VDSL splitters CSU/DSU	250R180 250R180T 250R145 250R145T 250R120 250R120T
North America Telcordia GR-974	*Primary protection modules MDF modules Network interface	250R180 250R180T 250R145 250R145T 250R120 250R120T
South America/Asia/Europe ITU K.20		
North America Telcordia GR-1089	*Intrabuilding communication systems LAN, VOIP cards Local loop handsets	250R180 250R180T 250R145 250R145T 250R120 250R120T
South America/Asia/Europe ITU K.20 and K.21		
	LAN Intrabuilding power cross Protection LAN equipment, IP phone	250R080

*Resistance binned parts are recommended

Soldering Parameters - Wave Soldering

Condition	Wave Soldering
Peak Temp/ DurationTime	260°C ≤ 5 Sec
≥ 220°C	2 Sec ~ 20 Sec
Preheat 140°C ~ 180°C	180 Sec ~ 210 Sec
Storage Condition	0°C~35°C ≤ 70%RH

- Recommended soldering methods: heat element oven or N₂ environment for lead-free.
- Devices are designed to be wave soldered to the bottom side of the board.
- Devices can be cleaned using standard industry methods and solvents.
- This profile can be used for lead-free device

Note: If soldering temperatures exceed the recommended profile, devices may not meet the performance requirements.

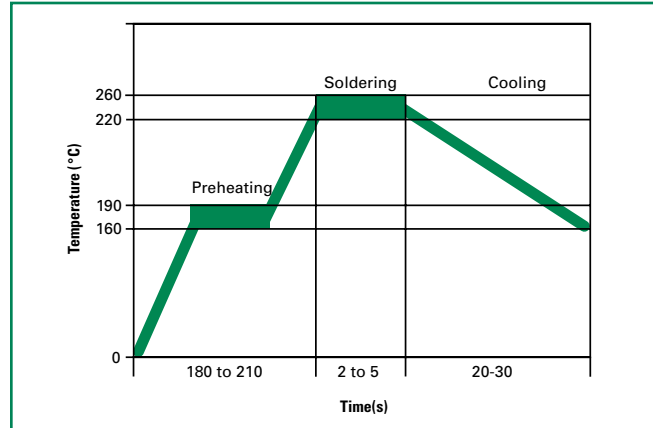

Physical Specifications

Lead Material	Tin-plated Copper
Soldering Characteristics	Solderability per MIL-STD-202, Method 208
Insulating Material	Cured, flame retardant epoxy polymer meets UL94V-0 requirements.
Device Labeling	Marked with 'LF', voltage, current rating, and date code.

Environmental Specifications

Operating/Storage Temperature	-40°C to +85°C
Maximum Device Surface Temperature in Tripped State	125°C
Passive Aging	65°C/85°C, 1000 hours
Humidity Aging	+85°C, 85% R.H., 1000 hours
Thermal Shock	MIL-STD-202, Method 107 +125°C to -55°C 10 times
Solvent Resistance	MIL-STD-202, Method 215
Moisture Sensitivity Level	Level 1, J-STD-020

Disclaimer Notice - Information furnished is believed to be accurate and reliable. However, users should independently evaluate the suitability of and test each product selected for their own applications. Littelfuse products are not designed for, and may not be used in, all applications. Read complete Disclaimer Notice at www.littelfuse.com/disclaimer-electronics.

Dimensions

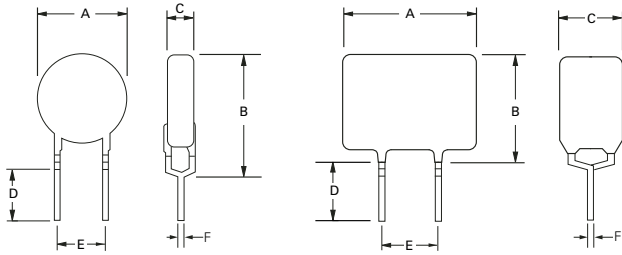
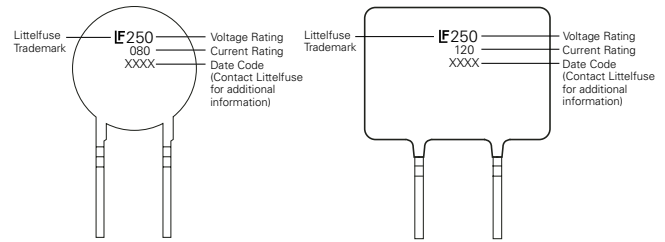

Figure 1

Figure 2

Part Marking System



Part Number	Figure	A		B		C		D		E		Physical Characteristics		
		Inches	mm	Inches	mm	Inches	mm	Inches	mm	Inches	mm	Lead (dia)		Material
		Max.	Max.	Max.	Max.	Max.	Max.	Min.	Min.	Typ.	Typ.	Inches	mm	
250R080	1	0.23	5.8	0.39	9.9	0.18	4.6	0.19	4.7	0.20	5.1	0.026	0.65	Sn/Cu
250R080T	1	0.23	5.8	0.39	9.9	0.18	4.6	0.19	4.7	0.20	5.1	0.026	0.65	Sn/Cu
250R120	2	0.27	6.8	0.43	11	0.18	4.6	0.19	4.7	0.20	5.1	0.026	0.65	Sn/Cu
250R120-RA	2	0.27	6.8	0.43	11	0.18	4.6	0.19	4.7	0.20	5.1	0.026	0.65	Sn/Cu
250R120-RC	2	0.27	6.8	0.43	11	0.18	4.6	0.19	4.7	0.20	5.1	0.026	0.65	Sn/Cu
250R120-RF	2	0.27	6.8	0.43	11	0.18	4.6	0.19	4.7	0.20	5.1	0.026	0.65	Sn/Cu
250R120-R1	2	0.27	6.8	0.43	11	0.18	4.6	0.19	4.7	0.20	5.1	0.026	0.65	Sn/Cu
250R120-R2	2	0.27	6.8	0.43	11	0.18	4.6	0.19	4.7	0.20	5.1	0.026	0.65	Sn/Cu
250R120-R3	2	0.27	6.8	0.43	11	0.18	4.6	0.19	4.7	0.20	5.1	0.026	0.65	Sn/Cu
250R120T	2	0.27	6.8	0.43	11	0.18	4.6	0.19	4.7	0.20	5.1	0.026	0.65	Sn/Cu
250R145	2	0.27	6.8	0.43	11	0.18	4.6	0.19	4.7	0.20	5.1	0.026	0.65	Sn/Cu
250R145-RA	2	0.27	6.8	0.43	11	0.18	4.6	0.19	4.7	0.20	5.1	0.026	0.65	Sn/Cu
250R145-RB	2	0.27	6.8	0.43	11	0.18	4.6	0.19	4.7	0.20	5.1	0.026	0.65	Sn/Cu
250R145T	2	0.27	6.8	0.43	11	0.18	4.6	0.19	4.7	0.20	5.1	0.026	0.65	Sn/Cu
250R180	1	0.37	9.5	0.47	12	0.18	4.6	0.19	4.7	0.20	5.1	0.026	0.65	Sn/Cu
250R180T	1	0.37	9.5	0.47	12	0.18	4.6	0.19	4.7	0.20	5.1	0.026	0.65	Sn/Cu

WARNING

- Users shall independently assess the suitability of these devices for each of their applications
- Operation of these devices beyond the stated maximum ratings could result in damage to the devices and lead to electrical arcing and/or fire
- These devices are intended to protect against the effects of temporary over-current or over-temperature conditions and are not intended to perform as protective devices where such conditions are expected to be repetitive or prolonged in duration
- Exposure to silicon-based oils, solvents, electrolytes, acids, and similar materials can adversely affect the performance of these PPTC devices
- These devices undergo thermal expansion under fault conditions, and thus shall be provided with adequate space and be protected against mechanical stresses
- Circuits with inductance may generate a voltage (L di/dt) above the rated voltage of the PPTC device.

Part Ordering Number System

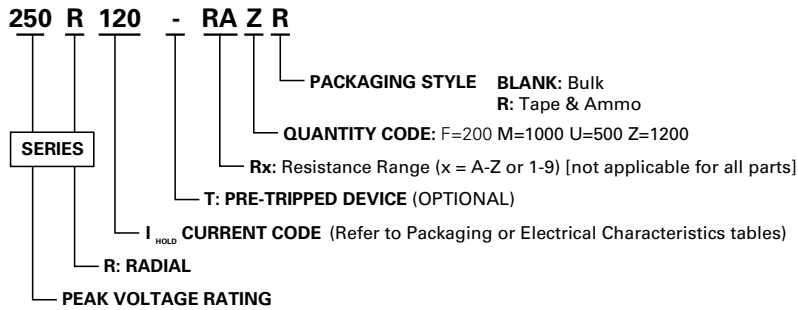

Packaging

Part Number	Ordering Number	I_{hold} (A)	I_{hold} Code	Packaging Option	Quantity	Quantity & Packaging Codes
250R080	250R080U	0.080	080	Bulk	500	U
	250R080ZR			Tape and Ammo	1200	ZR
250R080T	250R080TU	0.080	080	Bulk	500	U
	250R080TZR			Tape and Ammo	1200	ZR
250R120	250R120U	0.120	120	Bulk	500	U
	250R120ZR			Tape and Ammo	1200	ZR
250R120-RA	250R120-RAU	0.120	120	Bulk	500	U
	250R120-RAZR			Tape and Ammo	1200	ZR
250R120-RC	250R120-RCU	0.120	120	Bulk	500	U
	250R120-RCZR			Tape and Ammo	1200	ZR
250R120-RF	250R120-RFU	0.120	120	Bulk	500	U
	250R120-RFZR			Tape and Ammo	1200	ZR
250R120-R1	250R120-R1U	0.120	120	Bulk	500	U
	250R120-R1ZR			Tape and Ammo	1200	ZR
250R120-R2	250R120-R2U	0.120	120	Bulk	500	U
	250R120-R2ZR			Tape and Ammo	1200	ZR
250R120-R3	250R120-R3U	0.120	120	Bulk	500	U
	250R120-R3ZR			Tape and Ammo	1200	ZR
250R120T	250R120TU	0.120	120	Bulk	500	U
	250R120TZR			Tape and Ammo	1200	ZR
250R145	250R145U	0.145	145	Bulk	500	U
	250R145ZR			Tape and Ammo	1200	ZR
250R145-RA	250R145-RAU	0.145	145	Bulk	500	U
	250R145-RAZR			Tape and Ammo	1200	ZR
250R145-RB	250R145-RBU	0.145	145	Bulk	500	U
	250R145-RBZR			Tape and Ammo	1200	ZR
250R145T	250R145TU	0.145	145	Bulk	500	U
	250R145TZR			Tape and Ammo	1200	ZR
250R180	250R180F	0.180	180	Bulk	200	F
	250R180MR			Tape and Ammo	1000	MR
250R180T	250R180TF	0.180	180	Bulk	200	F
	250R180TMR			Tape and Ammo	1000	MR

Tape and Ammo Specifications

Devices taped using EIA468-B/IE286-2 standards. See table below and Figure 1 for details.

Dimension	EIA Mark	IEC Mark	Dimensions	
			Dim. (mm)	Tol. (mm)
Carrier tape width	W	W	18	-0.5 / +1.0
Hold down tape width	W₄	W₀	11	min.
Top distance between tape edges	W₆	W₂	3	max.
Sprocket hole position	W₅	W₁	9	-0.5 / +0.75
Sprocket hole diameter*	D₀	D₀	4	-0.32 / +0.2
Abscissa to plane (straight lead)	H	H	18.5	-/+ 3.0
Abscissa to plane (kinked lead)	H₀	H₀	16	-/+ 0.5
Abscissa to top	H₁	H₁	32.2	max.
Overall width without lead protrusion	C₁		42.5	max.
Overall width with lead protrusion	C₂		43.2	max.
Lead protrusion	L₁	I₁	1.0	max.
Protrusion of cut out	L	L	11	max.
Protrusion beyond hold-down tape	I₂	I₂	Not specified	
Sprocket hole pitch: 250R080-250R145	P₀	P₀	12.7	-/+ 0.3
Sprocket hole pitch: 250R180	P₀	P₀	25.4	-/+ 0.5
Pitch tolerance			20 consecutive.	-/+ 1
Device pitch: 250R080-250R145			12.7	
Device pitch: 250R180			25.4	
Tape thickness	t	t	0.9	max.
Tape thickness with splice	t₁		2.0	max.
Splice sprocket hole alignment			0	-/+ 0.3
Body lateral deviation	Δh	Δh	0	-/+ 1.0
Body tape plane deviation	Δp	Δp	0	-/+ 1.3
Ordinate to adjacent component lead*	P₁	P₁	3.81	-/+ 0.7
Lead spacing	F	F	5.1	-/+ 0.7

*Differs from EIA Specification

Tape and Ammo Diagram

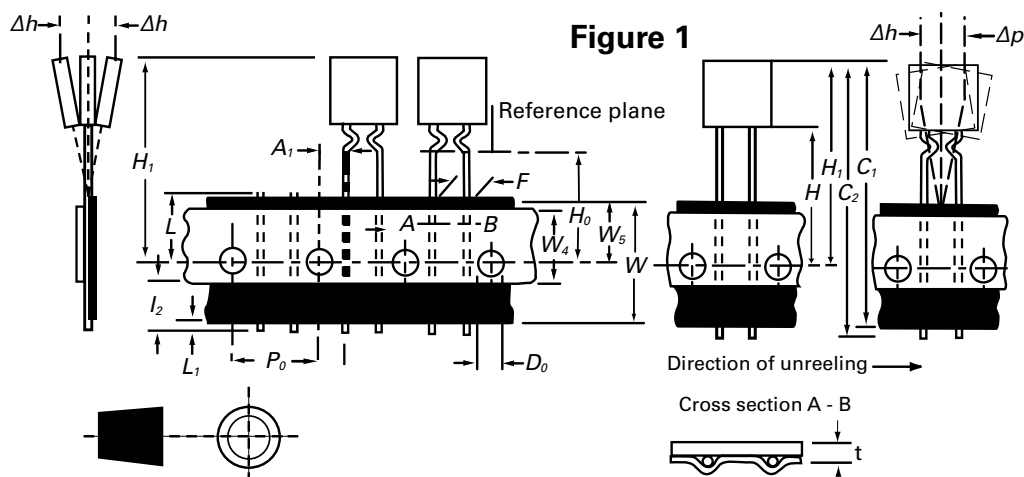

265R Series

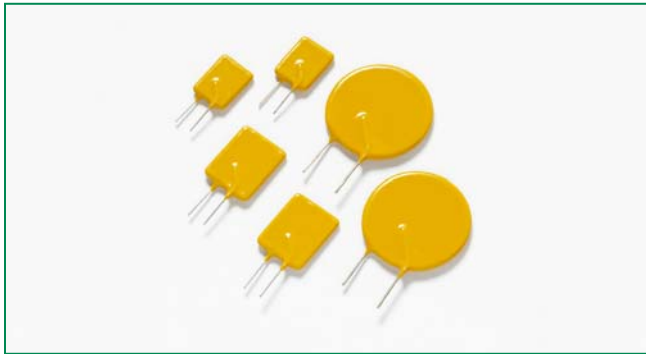

Description

The 265R Series is designed to protect against short duration high voltage fault currents (power cross or power induction surge) typically found in telecom applications (265Vrms). The series can be used to help telecom networking equipment meet the protection requirements specified in ITU K.20 and K.21.



Features

- Designed for line voltage applications
- Protection against both over-current and over-temperature
- Fast time-to-trip
- .05–2.0 hold current range
- 265VAC interrupt rating
- Binned and sorted narrow resistance ranges available
- RoHS compliant, Lead-Free and Halogen-Free*



Applications

- Customer Premises Equipment (CPE)
- Central Office (CO)/telecom centers
- LAN/WAN equipment
- Access equipment

Agency Approvals

AGENCY	AGENCY FILE NUMBER
	PENDING
	PENDING

Electrical Characteristics

Part Number	I _{hold} (A)	I _{trip} (A)	V _{max} (V _{int})	I _{max} (A)	Maximum Time To Trip		Resistance			Agency Approvals	
					Current (A)	Time (Sec.)	R _{min} (Ω)	R _{typ} (Ω)	R _{1max} (Ω)		
265R050	0.05	0.12	265	1.0	0.25	15.0	18.50	31.00	65.00	Pending	
265R080	0.08	0.19	265	1.2	0.40	15.0	7.40	12.00	26.00		
265R120	0.12	0.30	265	1.2	0.60	15.0	3.00	6.50	12.00		
265R160	0.16	0.37	265	2.0	0.80	15.0	2.50	4.10	7.80		
265R250	0.25	0.56	265	3.5	1.25	18.5	1.30	2.10	3.80		
265R330	0.33	0.80	265	4.5	1.65	21.0	0.77	1.24	2.60		
265R400	0.40	0.90	265	5.5	2.00	26.0	0.60	0.97	1.90		
265R550	0.55	1.25	265	7.0	2.75	26.0	0.45	0.73	1.45		
265R600	0.60	1.35	265	5.5	3.00	36.0	0.40	0.70	1.42		
265R750	0.75	1.50	265	7.5	3.75	18.0	0.32	0.48	0.84		
265R800	0.80	1.80	265	10.0	4.00	40.0	0.30	0.70	1.32		
265R1000	1.00	2.00	265	10.0	5.00	21.0	0.22	0.33	0.58		
265R1250	1.25	2.50	265	12.5	6.25	23.0	0.17	0.25	0.44		
265R2000	2.00	4.00	265	20.0	10.00	28.0	0.09	0.13	0.22		

I_{hold} = Hold current: maximum current device will pass without tripping in 25°C still air.

I_{trip} = Trip current: minimum current at which the device will trip in 25°C still air.

V_{int} = Maximum voltage the device can withstand without damage at rated current (I_{max})

V_{op} = The device regular operation voltage

I_{max} = Maximum fault current device can withstand without damage at rated voltage (V_{max})

P_g = Power dissipated from device when in the tripped state at 25°C still air.

R_{min} = Minimum resistance of device in initial (un-soldered) state.

R_{typ} = Typical resistance of device in initial (un-soldered) state.

R_{1max} = Maximum resistance of device at 25°C measured one hour after tripping.

Caution: Operation beyond the specified rating may result in damage and possible arcing and flame.

Temperature Derating

Part Number	Ambient Operation Temperature								
	-40°C	-20°C	0°C	20°C	40°C	50°C	60°C	70°C	85°C
265R050	0.080	0.075	0.620	0.050	0.040	0.035	0.030	0.025	0.017
265R080	0.128	0.120	0.100	0.080	0.064	0.056	0.048	0.040	0.028
265R120	0.192	0.180	0.150	0.120	0.096	0.084	0.072	0.060	0.042
265R160	0.256	0.240	0.200	0.160	0.128	0.112	0.096	0.080	0.056
265R250	0.400	0.375	0.315	0.250	0.200	0.175	0.150	0.125	0.087
265R330	0.630	0.500	0.420	0.330	0.270	0.230	0.200	0.170	0.110
265R400	0.640	0.600	0.500	0.400	0.320	0.280	0.240	0.200	0.210
265R550	0.930	0.820	0.690	0.550	0.470	0.410	0.360	0.300	0.230
265R600	0.960	0.900	0.750	0.600	0.480	0.420	0.360	0.300	0.210
265R750	1.450	1.240	0.990	0.750	0.650	0.580	0.520	0.450	0.380
265R800	1.280	1.200	1.000	0.800	0.640	0.560	0.480	0.400	0.280
265R1000	1.600	1.420	1.230	1.000	0.780	0.690	0.610	0.540	0.420
265R1250	2.030	1.810	1.580	1.250	1.080	0.980	0.860	0.750	0.630
265R2000	2.760	2.540	2.320	2.000	1.710	1.600	1.490	1.390	1.250

Average Time Current Curves

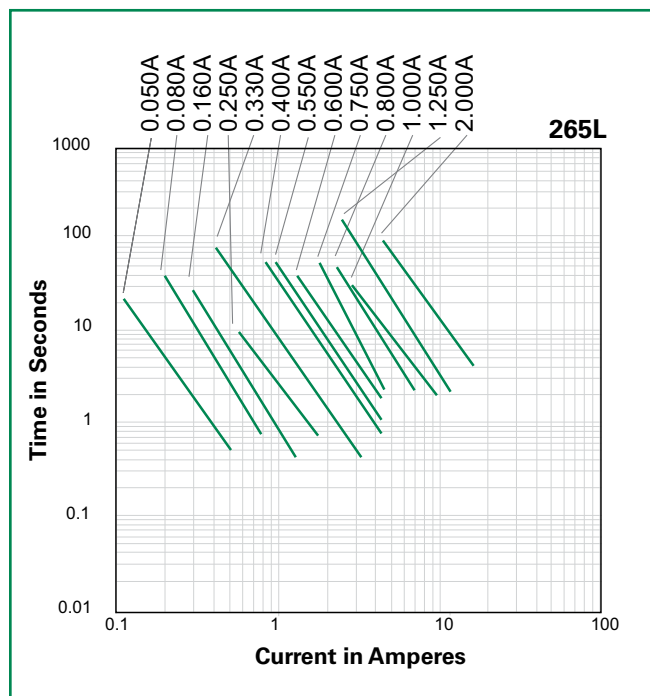

Temperature Derating Curve

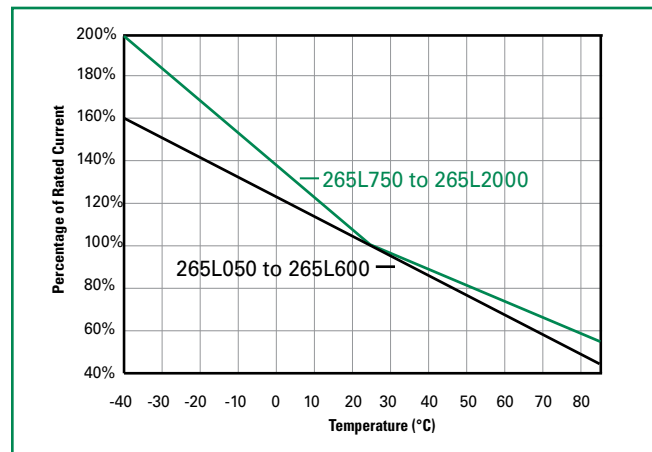

The average time current curves and Temperature Derating curve performance is affected by a number of variables, and these curves provided as guidance only. Customer must verify the performance in their application.

Soldering Parameters - Wave Soldering

Condition	Wave Soldering
Peak Temp/ Duration Time	260°C ≤ 5 Sec
≥ 220°C	2 Sec ~ 20 Sec
Preheat 140°C ~ 180°C	180 Sec ~ 210 Sec
Storage Condition	0°C~35°C ≤ 70%RH

- Recommended soldering methods: heat element oven or N₂ environment for lead-free.
- Devices are designed to be wave soldered to the bottom side of the board.
- Devices can be cleaned using standard industry methods and solvents.
- This profile can be used for lead-free device

Note: If soldering temperatures exceed the recommended profile, devices may not meet the performance requirements.

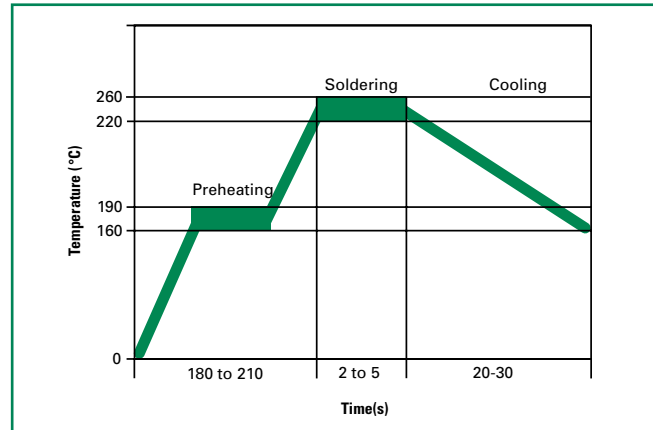

Physical Specifications

Lead Material	Tin-plated Copper
Soldering Characteristics	Solderability per MIL-STD-202, Method 208E
Insulating Material	Cured, flame retardant epoxy polymer meets UL94V-0 requirements.
Device Labeling	Marked with 'LF', voltage, current rating, and date code.

Environmental Specifications

Operating/Storage Temperature	-40°C to +85°C
Maximum Device Surface Temperature in Tripped State	125°C
Passive Aging	65°C/85°C, 1000 hours
Humidity Aging	+85°C, 85% R.H., 1000 hours
Thermal Shock	MIL-STD-202, Method 107 +125°C to -55°C 10 times
Solvent Resistance	MIL-STD-202, Method 215
Moisture Sensitivity Level	Level 1, J-STD-020C

WARNING

- Users shall independently assess the suitability of these devices for each of their applications
- Operation of these devices beyond the stated maximum ratings could result in damage to the devices and lead to electrical arcing and/or fire
- These devices are intended to protect against the effects of temporary over-current or over-temperature conditions and are not intended to perform as protective devices where such conditions are expected to be repetitive or prolonged in duration
- Exposure to silicon-based oils, solvents, electrolytes, acids, and similar materials can adversely affect the performance of these PPTC devices
- These devices undergo thermal expansion under fault conditions, and thus shall be provided with adequate space and be protected against mechanical stresses
- Circuits with inductance may generate a voltage (L di/dt) above the rated voltage of the PPTC device.

Disclaimer Notice - Information furnished is believed to be accurate and reliable. However, users should independently evaluate the suitability of and test each product selected for their own applications. Littelfuse products are not designed for, and may not be used in, all applications. Read complete Disclaimer Notice at www.littelfuse.com/disclaimer-electronics.

Dimensions

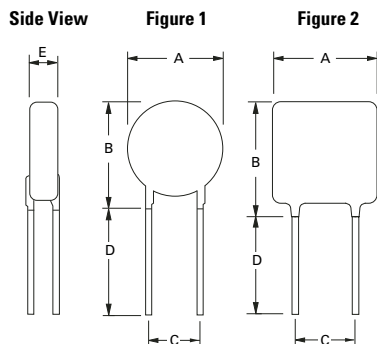

Part Marking System

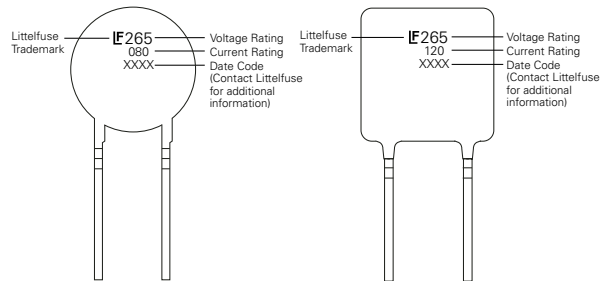

Part Number	Figure	A		B		C		D		E		Physical Characteristics		Material
		Inches	mm	Inches	mm	Inches	mm	Inches	mm	Inches	mm	Lead (dia)		
		Max.	Max.	Max.	Max.	Typ.	Typ.	Min.	Min.	Max.	Max.	Inches	mm	
265R050	1	0.327	8.3	0.421	10.7	0.201	5.1	0.299	7.6	0.150	3.8	0.024	0.6	Sn/Cu
265R080	1	0.327	8.3	0.421	10.7	0.201	5.1	0.299	7.6	0.150	3.8	0.024	0.6	Sn/Cu
265R120	1	0.327	8.3	0.421	10.7	0.201	5.1	0.299	7.6	0.150	3.8	0.024	0.6	Sn/Cu
265R160	1	0.390	9.9	0.492	12.5	0.201	5.1	0.299	7.6	0.150	3.8	0.024	0.6	Sn/Cu
265R250	2	0.378	9.6	0.685	17.4	0.201	5.1	0.299	7.6	0.150	3.8	0.024	0.6	Sn/Cu
265R330	2	0.453	11.5	0.650	16.5	0.201	5.1	0.299	7.6	0.150	3.8	0.024	0.6	Sn/Cu
265R400	2	0.453	11.5	0.768	19.5	0.201	5.1	0.299	7.6	0.150	3.8	0.024	0.6	Sn/Cu
265R550	2	0.551	14	0.854	21.7	0.201	5.1	0.299	7.6	0.161	4.1	0.031	0.8	Sn/Cu
265R600	2	0.453	11.5	0.768	19.5	0.201	5.1	0.299	7.6	0.150	3.8	0.024	0.6	Sn/Cu
265R750	2	0.453	11.5	0.921	23.4	0.201	5.1	0.201	5.1	0.189	4.8	0.031	0.8	Sn/Cu
265R800	2	0.512	13	0.886	22.5	0.201	5.1	0.299	7.6	0.150	3.8	0.024	0.6	Sn/Cu
265R1000	1	0.736	18.7	0.961	24.4	0.402	10.2	0.201	5.1	0.201	5.1	0.031	0.8	Sn/Cu
265R1250	1	0.835	21.2	1.079	27.4	0.402	10.2	0.201	5.1	0.209	5.3	0.031	0.8	Sn/Cu
250L2000	2	0.980	24.9	1.331	33.8	0.402	10.2	0.201	5.1	0.240	6.1	0.031	0.8	Sn/Cu

Part Ordering Number System

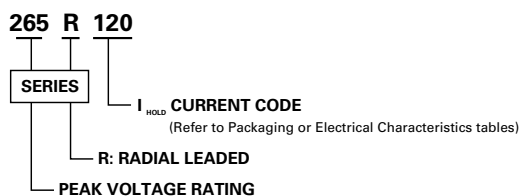

Packaging

Ordering Number	I _{hold} (A)	I _{hold} Code	Packaging Option	Quantity
265R050	0.05	050	Bulk	1000
265R080	0.08	080	Bulk	1000
265R120	0.12	120	Bulk	1000
265R160	0.16	160	Bulk	1000
265R250	0.25	250	Bulk	1000
265R330	0.33	330	Bulk	1000
265R400	0.40	400	Bulk	1000
265R550	0.55	550	Bulk	500
265R600	0.60	600	Bulk	500
265R750	0.75	750	Bulk	500
265R800	0.80	800	Bulk	500
265R1000	1.00	1000	Bulk	500
265R1250	1.25	1250	Bulk	500
265R2000	2.00	2000	Bulk	500

Additional Information



Datasheet



Resources



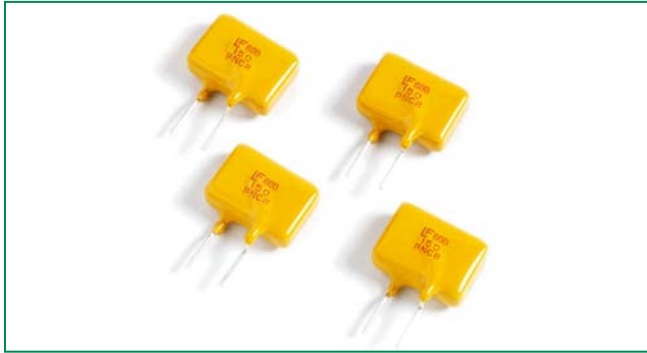

Samples

600R Series



Agency Approvals

AGENCY	AGENCY FILE NUMBER
	E183209
	R50120008

Description

The 600R Series is designed to protect against power fault events typically found in telecom applications. This series is designed to be used in applications that need to meet the requirements of GR-1089-CORE and UL60950/EN60950/IEC60950. These resettable devices also help to meet the requirements of ITU K.20, K.21 and K.44.



Features

- 0.15 – 0.16A hold current range, 60VDC operating voltage
- 600VAC interrupt rating
- Fast time-to-trip
- Binned and sorted narrow resistance ranges available
- RoHS compliant, Lead-Free and Halogen-Free*

Applications

- Secondary overcurrent protection for:
- Central Office Equipment (CO)
 - Customer Premises Equipment (CE)
 - Alarm systems
 - Set Top Boxes (STB)
 - Voice over IP (VOIP)
 - Subscriber Line Interface Circuit (SLIC)

Electrical Characteristics

Part Number	I _{hold} (A)	I _{trip} (A)	V _{max} V _{int} / V _{op}	I _{max} (A)	P _d typ. (W)	Maximum Time To Trip		Resistance			Agency Approvals	
						Current (A)	Time (Sec.)	R _{min} (Ω)	R _{typ} (Ω)	R _{1max} (Ω)		
600R150	0.15	0.30	600/60	3	1.00	1	4	6	10	17	X	X
600R150-RA	0.15	0.30	600/60	3	1.00	1	4	7	10	20	X	X
600R150-RB	0.15	0.30	600/60	3	1.00	1	3	9	12	22	X	X
600R160	0.16	0.32	600/60	3	1.00	1	10	4	10	18	X	X
600R160-RA	0.16	0.32	600/60	3	1.00	1	10	4	7	16	X	X
600R160-R1	0.16	0.32	600/60	3	1.00	1	10	4	8	17	X	X

I_{hold} = Hold current: maximum current device will pass without tripping in 20°C still air.

I_{trip} = Trip current: minimum current at which the device will trip in 20°C still air.

V_{max} = Maximum voltage the device can withstand without damage at rated current (I_{max})

V_{op} = The device regular operation voltage

I_{max} = Maximum fault current device can withstand without damage at rated voltage (V_{max})

P_d = Power dissipated from device when in the tripped state at 20°C still air.

R_{min} = Minimum resistance of device in initial (un-soldered) state.

R_{typ} = Typical resistance of device in initial (un-soldered) state.

R_{1max} = Maximum resistance of device at 20°C measured one hour after tripping.

Caution: Operation beyond the specified rating may result in damage and possible arcing and flame.

* Effective February 11, 2010 onward, all 600R PTC products will be manufactured Halogen Free (HF). Existing Non-Halogen Free 600R PTC products may continue to be sold, until supplies are depleted. This change will have no effect on 600R product specifications or performance.

WARNING

- Users shall independently assess the suitability of these devices for each of their applications
- Operation of these devices beyond the stated maximum ratings could result in damage to the devices and lead to electrical arcing and/or fire
- These devices are intended to protect against the effects of temporary over-current or over-temperature conditions and are not intended to perform as protective devices where such conditions are expected to be repetitive or prolonged in duration
- Exposure to silicon-based oils, solvents, electrolytes, acids, and similar materials can adversely affect the performance of these PPTC devices
- These devices undergo thermal expansion under fault conditions, and thus shall be provided with adequate space and be protected against mechanical stresses
- Circuits with inductance may generate a voltage (L di/dt) above the rated voltage of the PPTC device.

Temperature Derating

Part Number	Ambient Operation Temperature						
	-40°C	-20°C	0°C	23°C	40°C	60°C	85°C
600R150	0.241	0.219	0.183	0.150	0.129	0.102	0.74
600R160	0.274	0.244	0.206	0.160	0.135	0.093	0.44

Average Time Current Curves

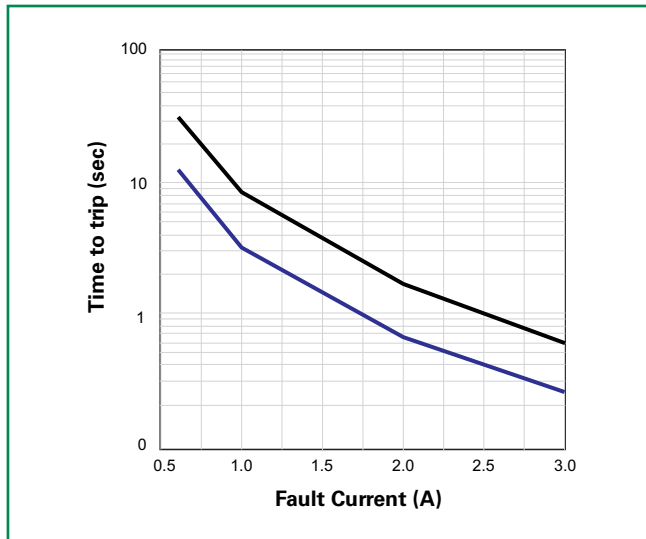

The average time current curves and Temperature Derating curve performance is affected by a number of variables, and these curves provided as guidance only. Customer must verify the performance in their application.

Temperature Derating Curve

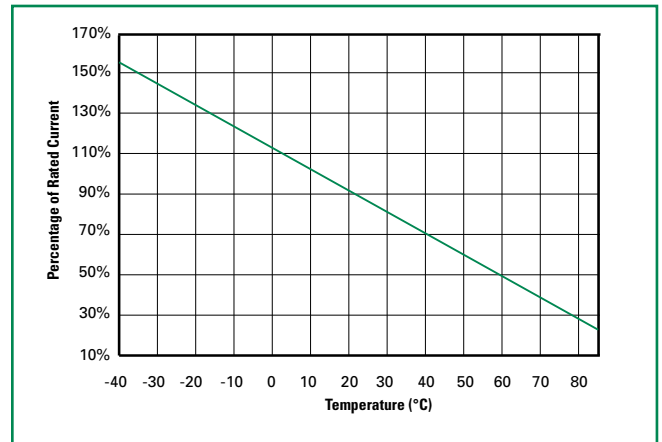

Note:
Typical Temperature derating curve, refer to table for derating data

Agency Specification Selection Guide For Telecom and Networking Applications

Part Number	Lightning	Power Cross
600R150 600R160	TIA-968-A – 1.5kV 10/160µs 800V 10/560µs Telcordia GR 1089 – 1.0kV 10/1000µs 2.5kV 2/10µs	UL60950, 3rd Ed – 600Vac, 40A Telcordia GR – 1089 – 600Vac, 60A

Devices should be independently evaluated and tested for use in any specific application

Protection Application Guide

Region/Specification	Application	Device Selection
North America Telcordia GR-1089	*Access network equipment Remote terminal Repeaters WAN equipment Cross-connect	600R150 600R160
North America TIA-968-A, UL60950	Customer and IT equipment Analog modems ADSL, XDSL modems Phone sets, PBX systems Internet appliances POS terminals	600R150 600R160
North America Telcordia GR-1089	Central Office POTS/ISDN linecards T1/E1/J1 linecards ADSL/VDSL splitters CSU/DSU	600R150 600R160
North America Telcordia GR-1089	*Intrabuilding communication systems LAN, VOIP cards Local loop handsets	600R150 600R160
South America/Asia/Europe ITU K.20 and K.21		

*Resistance binned parts are recommended

Soldering Parameters - Wave Soldering

Condition	Wave Soldering
Peak Temp/ DurationTime	260°C ≤ 5 Sec
≥ 220°C	2 Sec ~ 20 Sec
Preheat 140°C~ 180°C	180 Sec ~ 210 Sec
Storage Condition	0°C~35°C, ≤ 70%RH

- Recommended soldering methods: heat element oven or N₂ environment for lead-free
- Devices are designed to be wave soldered to the bottom side of the board.
- Devices can be cleaned using standard industry methods and solvents.
- This profile can be used for lead-free device

Note: If soldering temperatures exceed the recommended profile, devices may not meet the performance requirements.

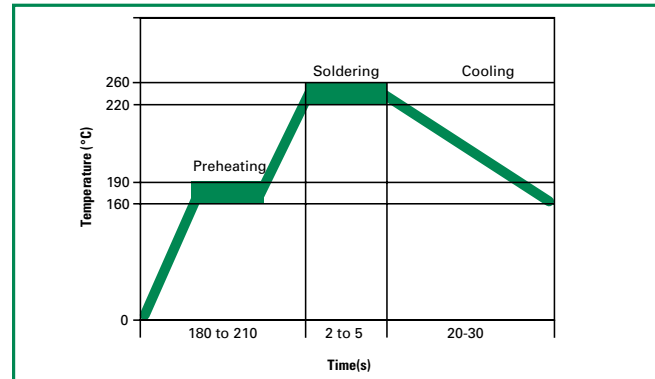

Additional Information



Datasheet



Resources



Samples

Physical Specifications

Lead Material	Tin-plated Copper
Soldering Characteristics	Solderability per MIL-STD-202, Method 208
Insulating Material	Cured, flame retardant epoxy polymer meets UL94V-0 requirements.
Device Labeling	Marked with 'LF', voltage, current rating, and date code.

Part Ordering Number System

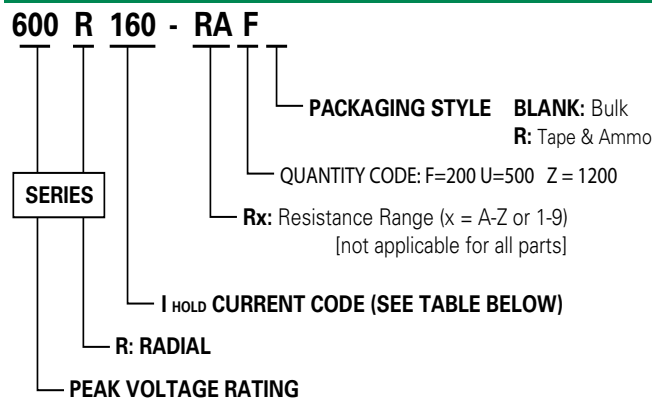

Part Marking System

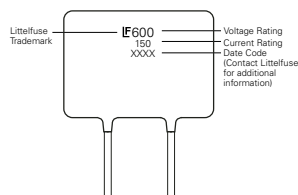

Environmental Specifications

Operating/Storage Temperature	-40°C to +85°C
Maximum Device Surface Temperature in Tripped State	125°C
Passive Aging	85°C/85°C, 1000 hours
Humidity Aging	+85°C, 85% R.H., 1000 hours
Thermal Shock	MIL-STD-202, Method 107 +125°C to -55°C 10 times
Solvent Resistance	MIL-STD-202, Method 215

Dimensions

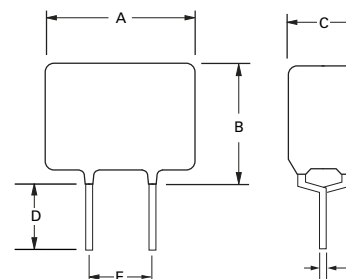

Part Number	A		B		C		D		E		Physical Characteristics		
	Inches	mm	Inches	mm	Inches	mm	Inches	mm	Inches	mm	Lead (dia)		Material
	Max.	Max.	Max.	Max.	Max.	Max.	Min.	Min.	Typ.	Typ.	Inches	mm	
600R150	0.35	9	0.49	12.5	0.18	4.6	0.19	4.7	0.20	5.1	0.026	0.65	Sn/Cu
600R150-RA	0.35	9	0.49	12.5	0.18	4.6	0.19	4.7	0.20	5.1	0.026	0.65	Sn/Cu
600R150-RB	0.35	9	0.49	12.5	0.18	4.6	0.19	4.7	0.20	5.1	0.026	0.65	Sn/Cu
600R160	0.63	16	0.50	12.6	0.24	6	0.19	4.7	0.20	5.1	0.026	0.65	Sn/Cu
600R160-RA	0.63	16	0.50	12.6	0.24	6	0.19	4.7	0.20	5.1	0.026	0.65	Sn/Cu
600R160-R1	0.63	16	0.50	12.6	0.24	6	0.19	4.7	0.20	5.1	0.026	0.65	Sn/Cu

Packaging

Part Number	Ordering Number	I_{hold} (A)	I_{hold} Code	Packaging Option	Quantity	Quantity & Packaging Codes
600R150	600R150F	0.15	150	Bulk	200	F
	600R150ZR			Tape and Ammo	1200	ZR
600R150-RA	600R150-RAF	0.15	150	Bulk	200	F
	600R150-RAZR			Tape and Ammo	1200	ZR
600R150-RB	600R150-RBF	0.15	150	Bulk	200	F
	600R150-RBZR			Tape and Ammo	1200	ZR
600R160	600R160F	0.16	160	Bulk	200	F
	600R160UR			Tape and Ammo	500	UR
600R160-RA	600R160-RAF	0.16	160	Bulk	200	F
	600R160-RAUR			Tape and Ammo	500	UR
600R160-R1	600R160-R1F	0.16	160	Bulk	200	F
	600R160-R1UR			Tape and Ammo	500	UR

Tape and Ammo Specifications

Devices taped using EIA468-B/E286-2 standards. See table below and Figure 1 for details.

Dimension	EIA Mark	IEC Mark	Dimensions	
			Dim. (mm)	Tol. (mm)
Carrier tape width	W	W	18	-0.5 / +1.0
Hold down tape width:	W₄	W₀	11	min.
Top distance between tape edges	W₆	W₂	3	max.
Sprocket hole position	W₅	W₁	9	-0.5 / +0.75
Sprocket hole diameter*	D₀	D₀	4	-0.32 / +0.2
Abscissa to plane(straight lead)	H	H	18.5	-/+ 3.0
Abscissa to plane(kinked lead)	H₀	H₀	16	-/+ 0.5
Abscissa to top	H₁	H₁	32.2	max.
Overall width w/o lead protrusion	C₁		42.5	max.
Overall width w/ lead protrusion	C₂		43.2	max.
Lead protrusion	L₁	I₁	1.0	max.
Protrusion of cut out	L	L	11	max.
Protrusion beyond hold-down tape	I₂	I₂	Not specified	
Sprocket hole pitch: 600R150 & 600R160	P₀	P₀	25.4	-/+ 0.5
Device pitch: 600R150 & 600R160			25.4	
Pitch tolerance			20 consecutive.	-/+ 1
Tape thickness	t	t	0.9	max.
Tape thickness with splice	t₁		2.0	max.
Splice sprocket hole alignment			0	-/+ 0.3
Body lateral deviation	Δh	Δh	0	-/+ 1.0
Body tape plane deviation	Δp	Δp	0	-/+ 1.3
Ordinate to adjacent component lead*	P₁	P₁	3.81	-/+ 0.7
Lead spacing	F	F	5.08	-/+ 0.8

*Differs from EIA Specification

Tape and Ammo Diagram

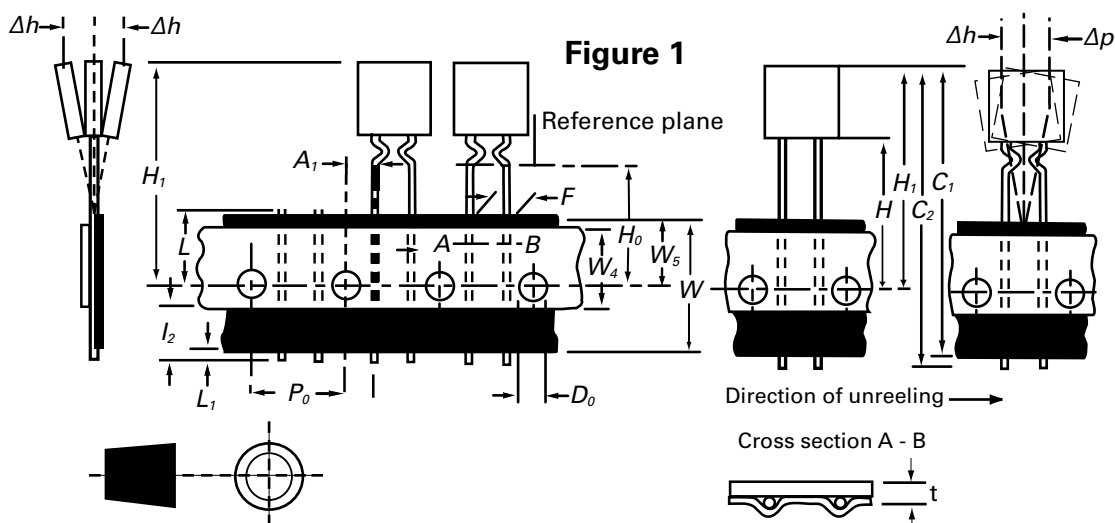

Disclaimer Notice - Information furnished is believed to be accurate and reliable. However, users should independently evaluate the suitability of and test each product selected for their own applications. Littelfuse products are not designed for, and may not be used in, all applications. Read complete Disclaimer Notice at www.littelfuse.com/disclaimer-electronics.

SL LoRho Battery Strap Series

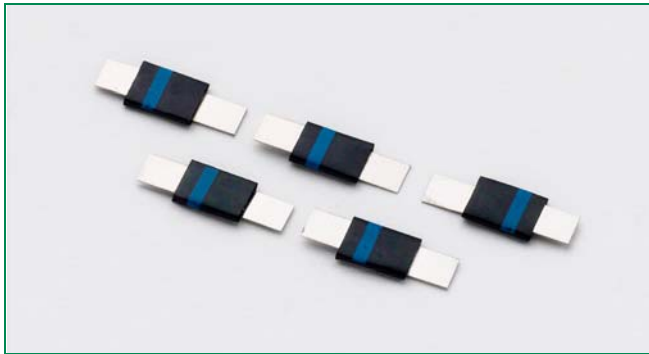

Description

The new Littelfuse SL LoRho Battery Strap Series PPTC (polymer positive temperature coefficient) is designed with a proprietary conductive polymer material, to provide both over-current and over-temperature protection for rechargeable battery cells. This series features a slim, low profile and low resistance design to install directly on the latest generations of battery cells for a longer battery run time.

Features

- Low Profile
- Lo Rho (low resistance at normal operating hold current)
- Installs Directly on battery cell
- RoHS Compliant, lead-free and halogen-free

Applications

- Rechargeable battery cell protection

Agency Approvals

AGENCY	AGENCY FILE NUMBER
	E183209
	R50119583

Electrical Characteristics

Part Number	I _{hold} (A)	I _{trip} (A)	V _{max} (Vdc)	I _{max} (A)	P _{d max.} (W)	Maximum Time To Trip		Resistance			Agency Approvals	
						Current (A)	Time (Sec.)	R _{min} (Ω)	R _{max} (Ω)	R _{1max} (Ω)		
06SL190G	1.9	4.9	6	50	1.0	9.5	3.00	0.006	0.013	0.024	X	X
06SL370G	3.7	9.0	6	50	1.2	18.5	5.00	0.005	0.013	0.020	X	X

I_{hold} = Hold current: maximum current device will pass without tripping in 20°C still air.
 I_{trip} = Trip current: minimum current at which the device will trip in 20°C still air.
 V_{max} = Maximum voltage device can withstand without damage at rated current (I_{max})
 I_{max} = Maximum fault current device can withstand without damage at rated voltage (V_{max})
 P_d = Power dissipated from device when in the tripped state at 20°C still air.

R_{min} = Minimum resistance of device in initial (un-soldered) state.
 R_{max} = Maximum resistance of device in initial (un-soldered) state.
 R_{1max} = Maximum resistance of device at 20°C measured one hour after tripping
Caution: Operation beyond the specified rating may result in damage and possible arcing and flame.

Temperature Derating

Part Number	Ambient Operation Temperature									
	-40°C	-20°C	0°C	20°C	40°C	50°C	60°C	70°C	85°C	
	Hold Current (A)									
06SL190G	3.40	3.00	2.60	1.90	1.70	1.40	1.20	1.00	0.70	
06SL370G	5.90	5.20	4.80	3.70	3.10	2.80	2.20	1.70	1.20	

WARNING

- Users shall independently assess the suitability of these devices for each of their applications
- Operation of these devices beyond the stated maximum ratings could result in damage to the devices and lead to electrical arcing and/or fire
- These devices are intended to protect against the effects of temporary over-current or over-temperature conditions and are not intended to perform as protective devices where such conditions are expected to be repetitive or prolonged in duration
- Exposure to silicon-based oils, solvents, electrolytes, acids, and similar materials can adversely affect the performance of these PPTC devices
- These devices undergo thermal expansion under fault conditions, and thus shall be provided with adequate space and be protected against mechanical stresses
- Circuits with inductance may generate a voltage (L di/dt) above the rated voltage of the PPTC device.

Disclaimer Notice - Information furnished is believed to be accurate and reliable. However, users should independently evaluate the suitability of and test each product selected for their own applications. Littelfuse products are not designed for, and may not be used in, all applications. Read complete Disclaimer Notice at www.littelfuse.com/disclaimer-electronics.

LR Series

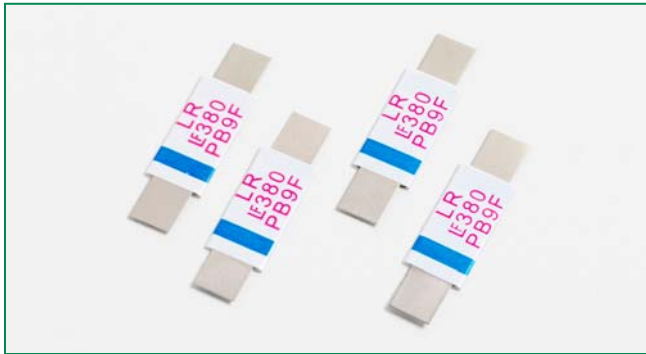

Description

The new LR Series device provides reliable, noncycling protection against overcharging and short circuits events for rechargeable battery cells where resettable protection is desired.

Features

- RoHS compliant and lead-free
- Weldable Nickel terminals
- Slim, low profile design
- Compact design saves board space
- Low resistance
- Fast trip time

Applications

- Rechargeable battery cell protection
- Portable Computers
- Camcorders

Additional Information



Datasheet





Resources





Samples

Agency Approvals

AGENCY	AGENCY FILE NUMBER
	E183209
	R50119583

Electrical Characteristics

Part Number	I _{hold} (A)	I _{trip} (A)	V _{max} (Vdc)	I _{max} (A)	P _d max. (W)	Maximum Time To Trip		Resistance			Agency Approvals	
						Current (A)	Time (Sec.)	R _{min} (Ω)	R _{typ} (Ω)	R _{1max} (Ω)		
15LR260	2.6	5.8	15	100	2.5	13.00	5.00	0.020	0.042	0.063	X	X
15LR380	3.8	8.3	15	100	2.5	19.00	5.00	0.013	0.026	0.037	X	X
20LR450	4.5	8.9	20	100	2.5	22.50	5.00	0.011	0.020	0.028	X	X
20LR730	7.3	14.1	20	100	3.3	30.00	5.00	0.006	0.012	0.015	X	X

I_{hold} = Hold current: maximum current device will pass without tripping in 20°C still air.

I_{trip} = Trip current: minimum current at which the device will trip in 20°C still air.

V_{max} = Maximum voltage device can withstand without damage at rated current (I_{max})

I_{max} = Maximum fault current device can withstand without damage at rated voltage (V_{max})

P_d = Power dissipated from device when in the tripped state at 20°C still air.

R_{min} = Minimum resistance of device in initial (un-soldered) state.

R_{typ} = Typical resistance of device in initial (un-soldered) state.

R_{1max} = Maximum resistance of device at 20°C measured one hour after tripping or reflow soldering of 260°C for 20 sec.

Caution: Operation beyond the specified rating may result in damage and possible arcing and flame.

Temperature Derating

Ambient Operation Temperature

Part Number	-40°C	-20°C	0°C	20°C	40°C	50°C	60°C	70°C	85°C
	Hold Current (A)								
15LR260	3.80	3.40	3.10	2.60	2.20	2.00	1.90	1.70	1.40
15LR380	5.50	4.90	4.40	3.80	3.30	3.00	2.80	2.50	2.10
20LR450	6.50	5.80	5.30	4.50	3.90	3.60	3.30	2.90	2.50
20LR730	10.60	9.50	8.60	7.30	6.30	5.70	5.40	4.70	4.00

Average Time Current Curves

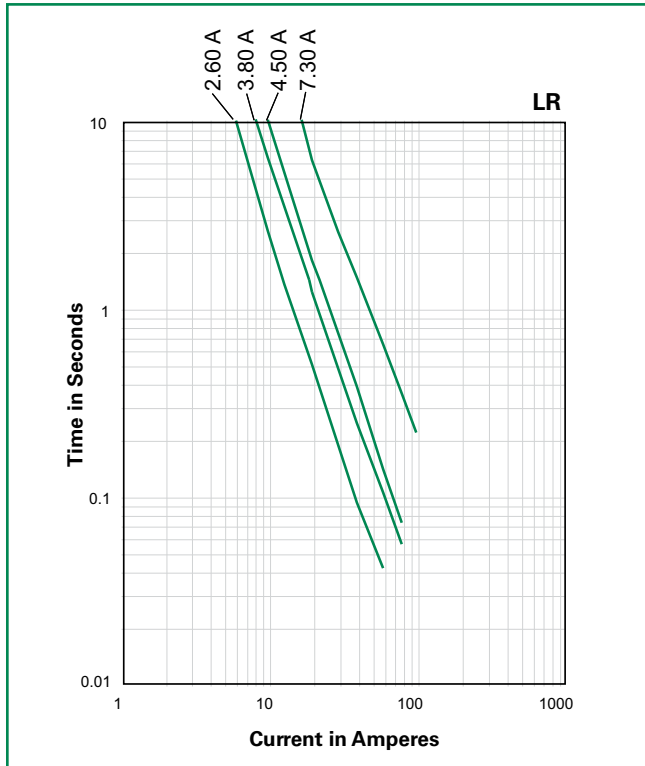

The average time current curves and Temperature Rerating curve performance is affected by a number of variables, and these curves provided as guidance only. Customer must verify the performance in their application.

Temperature Rerating Curve

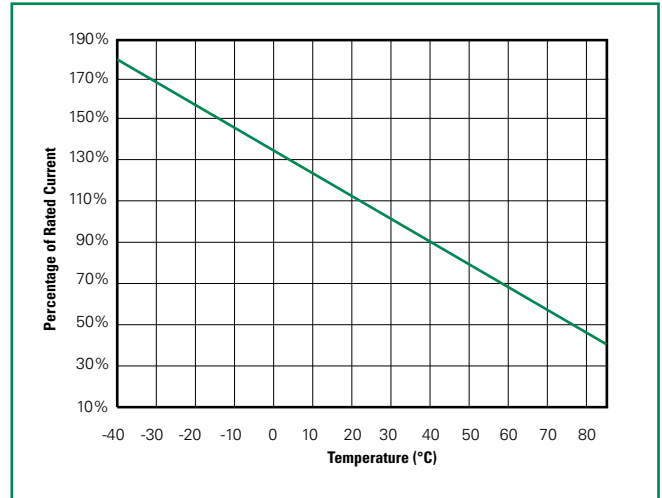

Note:
Typical Temperature rerating curve, refer to table for derating data

Physical Specifications

Terminal Material	0.13mm nominal thickness, quarter-hard Nickel
Insulating Material	Polyester tape

Environmental Specifications

Operating/Storage Temperature	-40°C to +85°C
Maximum Device Surface Temperature in Tripped State	125°C
Passive Aging	+70°C, 1000 hours -/+10% typical resistance change
Humidity Aging	+85°C, 85% R.H., 7 days -/+5% typical resistance change
Vibration	MIL-STD-883, Method 2007, Condition A, No change

WARNING

- Users shall independently assess the suitability of these devices for each of their applications
- Operation of these devices beyond the stated maximum ratings could result in damage to the devices and lead to electrical arcing and/or fire
- These devices are intended to protect against the effects of temporary over-current or over-temperature conditions and are not intended to perform as protective devices where such conditions are expected to be repetitive or prolonged in duration
- Exposure to silicon-based oils, solvents, electrolytes, acids, and similar materials can adversely affect the performance of these PPTC devices
- These devices undergo thermal expansion under fault conditions, and thus shall be provided with adequate space and be protected against mechanical stresses
- Circuits with inductance may generate a voltage (L di/dt) above the rated voltage of the PPTC device.

Dimensions

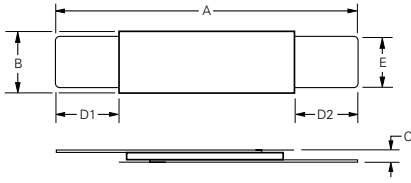

Part Number	A				B				C				D1		D2		E			
	Inches		mm		Inches		mm		Inches		mm		Inches	mm	Inches	mm	Inches		mm	
	Min.	Max.	Min.	Max.	Min.	Max.	Min.	Max.	Min.	Max.	Min.	Max.	Min.	Min.	Min.	Min.	Min.	Max.	Min.	Max.
15LR260	0.82	0.91	20.90	23.10	0.19	0.22	4.90	5.50	0.02	0.04	0.60	1.00	0.16	4.10	0.16	4.10	0.01	0.16	3.90	4.10
15LR380	0.94	1.02	24.00	26.00	0.27	0.30	6.90	7.50	0.02	0.04	0.60	1.00	0.16	4.10	0.16	4.10	0.01	0.16	4.90	5.10
20LR450	0.94	1.02	24.00	26.00	0.39	0.41	9.90	10.50	0.02	0.04	0.60	1.00	0.21	5.30	0.21	5.30	0.01	0.21	5.90	6.10
20LR730	1.07	1.15	27.10	29.10	0.55	0.57	13.90	14.50	0.02	0.04	0.60	1.00	0.16	4.10	0.16	4.10	0.01	0.16	5.90	6.10

Part Marking System

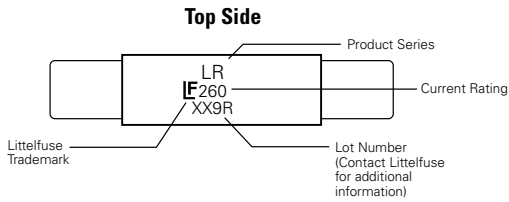

Part Ordering Number System

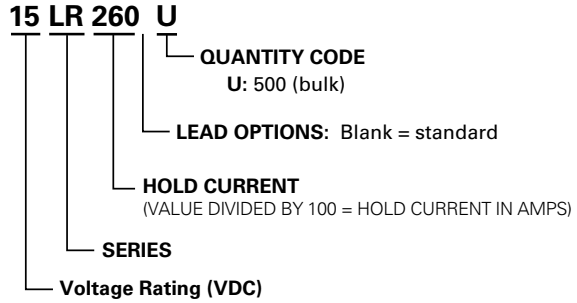

Packaging

Part Number	Ordering Number	I_{hold} (A)	I_{hold} Code	Packaging Option	Quantity	Quantity & Packaging Codes
15LR260	15LR260U	2.6	260	Bulk	500	U
15LR380	15LR380U	3.8	380	Bulk	500	U
20LR450	20LR450U	4.5	450	Bulk	500	U
20LR730	20LR730U	7.3	730	Bulk	500	U

Disclaimer Notice - Information furnished is believed to be accurate and reliable. However, users should independently evaluate the suitability of and test each product selected for their own applications. Littelfuse products are not designed for, and may not be used in, all applications. Read complete Disclaimer Notice at www.littelfuse.com/disclaimer-electronics.

LT Series



Description

The new LT Series device provides reliable, noncycling protection against overcharging and short circuits events for rechargeable battery cells where resettable protection is desired.



Features

- RoHS compliant and lead-free
- Weldable Nickel terminals
- Compact design saves board space
- Low resistance
- Provides overcurrent protection at 100°C trip temperature



Applications

- Rechargeable battery cell protection
 - Mobile phones
 - Laptop computers

Agency Approvals

AGENCY	AGENCY FILE NUMBER
	E183209
	R50119583

Electrical Characteristics

Part Number	I _{hold} (A)	I _{trip} (A)	V _{max} (Vdc)	I _{max} (A)	P _{d max.} (W)	Maximum Time To Trip		Resistance			Agency Approvals	
						Current (A)	Time (Sec.)	R _{min} (Ω)	R _{typ} (Ω)	R _{1max} (Ω)		
24LT100	1.0	2.5	24	100	1.5	5.00	7.00	0.070	0.130	0.260	X	X

I_{hold} = Hold current: maximum current device will pass without tripping in 20°C still air.
 I_{trip} = Trip current: minimum current at which the device will trip in 20°C still air.
 V_{max} = Maximum voltage device can withstand without damage at rated current (I_{max})
 I_{max} = Maximum fault current device can withstand without damage at rated voltage (V_{max})
 P_d = Power dissipated from device when in the tripped state at 20°C still air.
 R_{min} = Minimum resistance of device in initial (un-soldered) state.

R_{typ} = Typical resistance of device in initial (un-soldered) state.
 R_{1max} = Maximum resistance of device at 20°C measured one hour after tripping or reflow soldering of 260°C for 20 sec.
Caution: Operation beyond the specified rating may result in damage and possible arcing and flame.

Temperature Derating

Part Number	Ambient Operation Temperature									
	-40°C	-20°C	0°C	20°C	40°C	50°C	60°C	70°C	85°C	
24LT100	Hold Current (A)									
24LT100	1.86	1.60	1.40	1.00	0.80	0.70	0.60	0.44	0.23	

WARNING

- Users shall independently assess the suitability of these devices for each of their applications
- Operation of these devices beyond the stated maximum ratings could result in damage to the devices and lead to electrical arcing and/or fire
- These devices are intended to protect against the effects of temporary over-current or over-temperature conditions and are not intended to perform as protective devices where such conditions are expected to be repetitive or prolonged in duration
- Exposure to silicon-based oils, solvents, electrolytes, acids, and similar materials can adversely affect the performance of these PPTC devices
- These devices undergo thermal expansion under fault conditions, and thus shall be provided with adequate space and be protected against mechanical stresses
- Circuits with inductance may generate a voltage (L di/dt) above the rated voltage of the PPTC device.

Average Time Current Curves

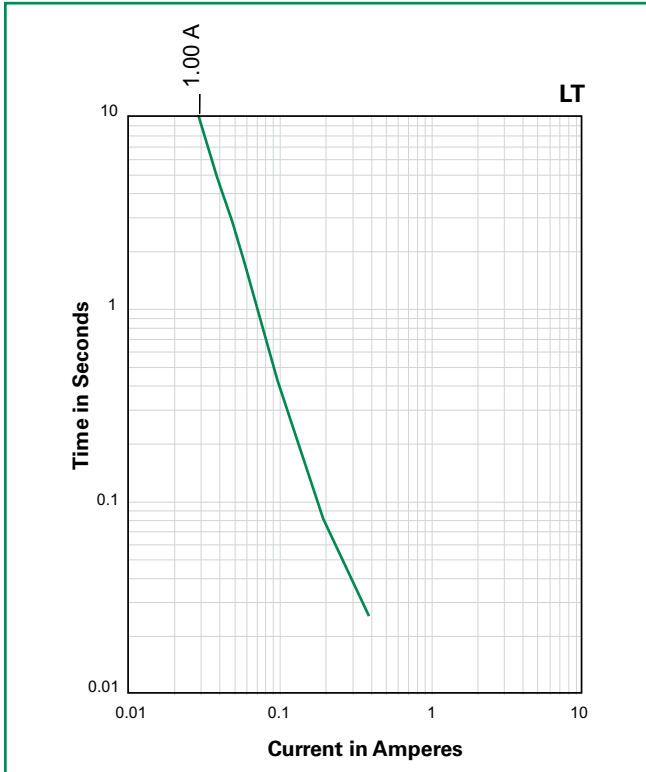

The average time current curves and Temperature Rerating curve performance is affected by a number of variables, and these curves provided as guidance only. Customer must verify the performance in their application.

Temperature Rerating Curve

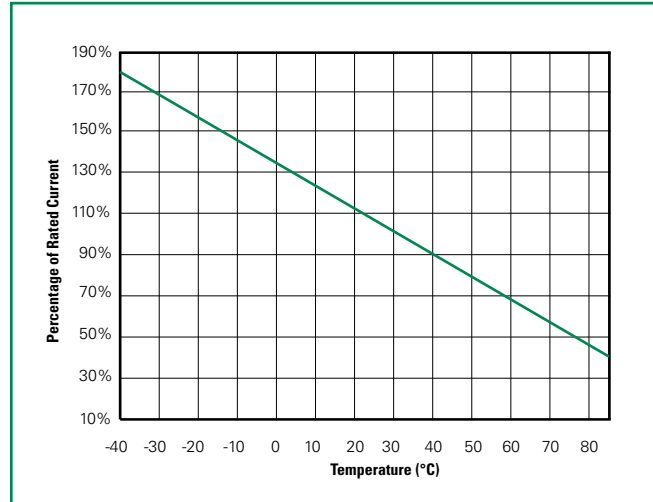

Note:
Typical Temperature rerating curve, refer to table for derating data

Physical Specifications

Terminal Material	0.13mm nominal thickness, quarter-hard Nickel
Insulating Material	Polyester tape

Environmental Specifications

Operating/Storage Temperature	-40°C to +85°C
Maximum Device Surface Temperature in Tripped State	125°C
Passive Aging	+70°C, 1000 hours -/+10% typical resistance change
Humidity Aging	+85°C, 85% R.H., 7 days, -/+5% typical resistance change
Vibration	MIL-STD-883, Condition A, No change

Additional Information



Datasheet



Resources



Samples

Dimensions

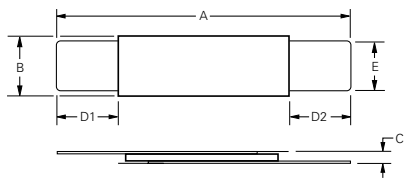

Part Number	A				B				C				D1		D2		E			
	Inches		mm		Inches		mm		Inches		mm		in.	mm	in.	mm	Inches		mm	
	Min.	Max.	Min.	Max.	Min.	Max.	Min.	Max.	Min.	Max.	Min.	Max.	Min.	Min.	Min.	Min.	Min.	Max.	Min.	Max.
24LT100	0.82	0.91	20.9	23.1	0.19	0.20	4.9	5.2	0.02	0.04	0.6	1	0.16	4.1	0.16	4.1	0.01	0.16	3.9	4.1

Part Marking System

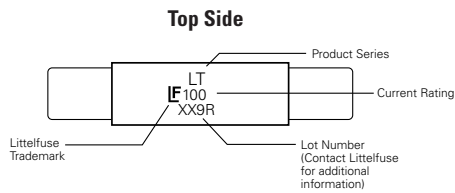

Part Ordering Number System

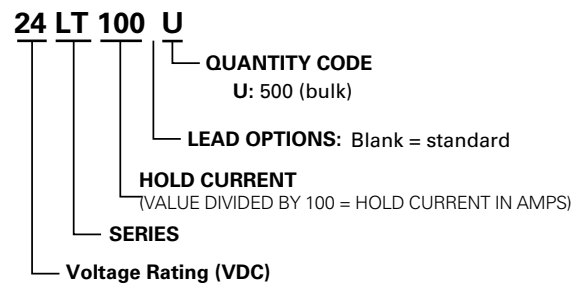

Packaging

Part Number	Ordering Number	I _{hold} (A)	I _{hold} Code	Packaging Option	Quantity	Quantity & Packaging Codes
24LT100	24LT100U	1.0	100	Bulk	500	U

Disclaimer Notice - Information furnished is believed to be accurate and reliable. However, users should independently evaluate the suitability of and test each product selected for their own applications. Littelfuse products are not designed for, and may not be used in, all applications. Read complete Disclaimer Notice at www.littelfuse.com/disclaimer-electronics.

ST Series

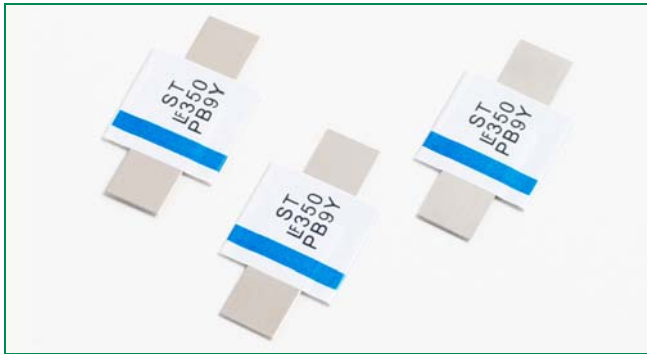

Description

The new ST Series device provides reliable, noncycling protection against overcharging and short circuits events for rechargeable battery cells where resettable protection is desired.

Features

- RoHS compliant and lead-free
- Weldable Nickel terminals
- Low resistance
- Provides overcurrent protection at 125°C trip temperature

Applications

- Rechargeable battery cell protection

Agency Approvals

AGENCY	AGENCY FILE NUMBER
	E183209
	R50119583

Electrical Characteristics

Part Number	I _{hold} (A)	I _{trip} (A)	V _{max} (Vdc)	I _{max} (A)	P _{d max.} (W)	Maximum Time To Trip		Resistance			Agency Approvals	
						Current (A)	Time (Sec.)	R _{min} (Ω)	R _{typ} (Ω)	R _{1max} (Ω)		
15ST175	1.75	3.8	15	100	2.5	8.75	5.00	0.050	0.090	0.120	X	X

I_{hold} = Hold current: maximum current device will pass without tripping in 20°C still air.
 I_{trip} = Trip current: minimum current at which the device will trip in 20°C still air.
 V_{max} = Maximum voltage device can withstand without damage at rated current (I_{max})
 I_{max} = Maximum fault current device can withstand without damage at rated voltage (V_{max})
 P_d = Power dissipated from device when in the tripped state at 20°C still air.
 R_{min} = Minimum resistance of device in initial (un-soldered) state.

R_{typ} = Typical resistance of device in initial (un-soldered) state.
 R_{1max} = Maximum resistance of device at 20°C measured one hour after tripping or reflow soldering of 260°C for 20 sec.
Caution: Operation beyond the specified rating may result in damage and possible arcing and flame.

Temperature Rating

Ambient Operation Temperature									
	-40°C	-20°C	0°C	20°C	40°C	50°C	60°C	70°C	85°C
Part Number	Hold Current (A)								
15ST175	2.50	2.30	2.00	1.75	1.50	1.30	1.20	1.10	0.90

WARNING

- Users shall independently assess the suitability of these devices for each of their applications
- Operation of these devices beyond the stated maximum ratings could result in damage to the devices and lead to electrical arcing and/or fire
- These devices are intended to protect against the effects of temporary over-current or over-temperature conditions and are not intended to perform as protective devices where such conditions are expected to be repetitive or prolonged in duration
- Exposure to silicon-based oils, solvents, electrolytes, acids, and similar materials can adversely affect the performance of these PPTC devices
- These devices undergo thermal expansion under fault conditions, and thus shall be provided with adequate space and be protected against mechanical stresses
- Circuits with inductance may generate a voltage (L di/dt) above the rated voltage of the PPTC device.

Average Time Current Curves

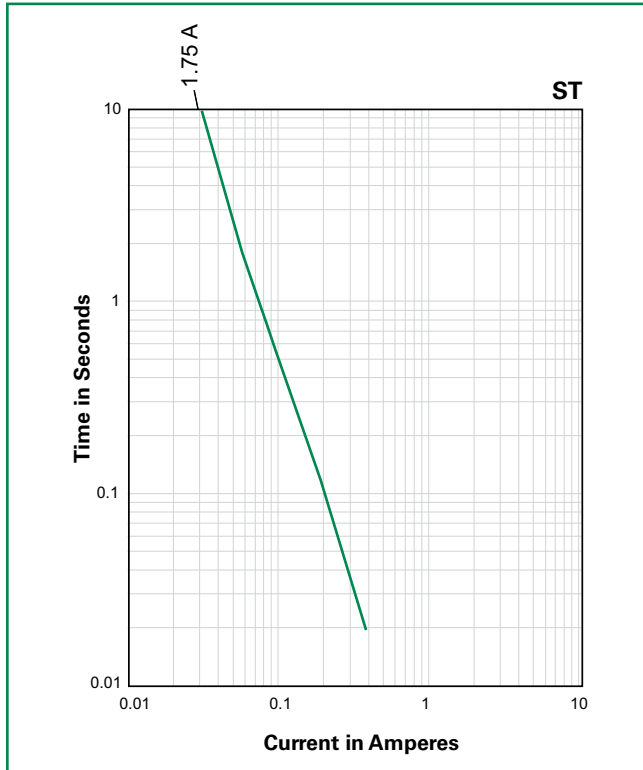

The average time current curves and Temperature Rerating curve performance is affected by a number of variables, and these curves provided as guidance only. Customer must verify the performance in their application.

Temperature Rerating Curve

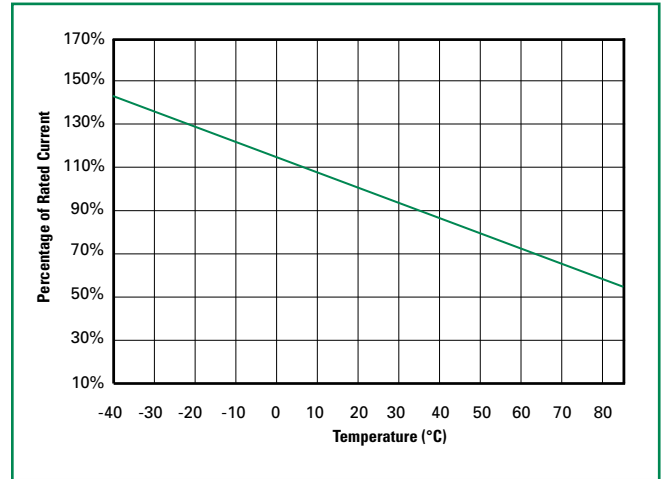

Note:
Typical Temperature rerating curve, refer to table for derating data

Physical Specifications

Lead Material	0.13mm nominal thickness, quarter-hard Nickel
Insulating Material	Polyester tape

Additional Information



Datasheet



Resources



Samples

Environmental Specifications

Operating/Storage Temperature	-40°C to +85°C
Maximum Device Surface Temperature in Tripped State	125°C
Passive Aging	+70°C, 1000 hours -/+5% typical resistance change
Humidity Aging	+85°C, 85% R.H., 7 days, -/+5% typical resistance change
Vibration	MIL-STD-883, Condition A, No change

Dimensions

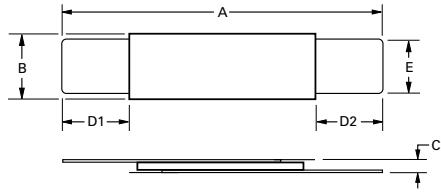

Part Number	A				B				C				D1		D2		E			
	Inches		mm		Inches		mm		Inches		mm		Inches	mm	Inches	mm	Inches		mm	
	Min.	Max.	Min.	Max.	Min.	Max.	Min.	Max.	Min.	Max.	Min.	Max.	Min.	Min.	Min.	Min.	Min.	Max.	Min.	Max.
15ST175	0.82	0.91	20.9	23.1	0.19	0.20	4.9	5.2	0.02	0.04	0.6	1.0	0.16	4.1	0.16	4.1	0.01	0.16	3.9	4.1

Part Marking System

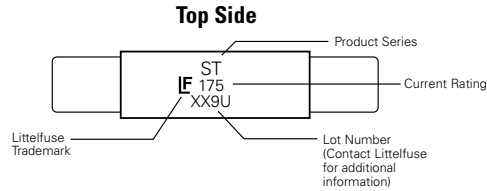

Part Ordering Number System

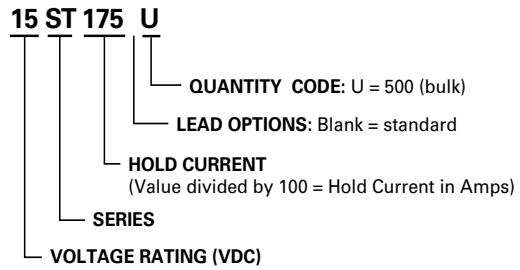

Packaging

Part Number	Ordering Number	I_{hold} (A)	I_{hold} Code	Packaging Option	Quantity	Quantity & Packaging Codes
15ST175	15ST175U	1.75	175	Bulk	500	U

Disclaimer Notice - Information furnished is believed to be accurate and reliable. However, users should independently evaluate the suitability of and test each product selected for their own applications. Littelfuse products are not designed for, and may not be used in, all applications. Read complete Disclaimer Notice at www.littelfuse.com/disclaimer-electronics.

VL Series



Description

The new VL Series device provides reliable, noncycling protection against overcharging and short circuits events for rechargeable battery cells where resettable protection is desired.

Features

- RoHS compliant and lead-free
- Compact design saves board space
- Weldable Nickel terminals
- Low resistance
- Slim, low profile design

Applications

- Rechargeable battery cell protection

Agency Approvals

AGENCY	AGENCY FILE NUMBER
	E183209
	R50119583

Electrical Characteristics

Part Number	I _{hold} (A)	I _{trip} (A)	V _{max} (Vdc)	I _{max} (A)	P _{d max.} (W)	Maximum Time To Trip		Resistance			Agency Approvals	
						Current (A)	Time (Sec.)	R _{min} (Ω)	R _{typ} (Ω)	R _{1max} (Ω)		
12VL175XL	1.75	4.20	12	100	1.4	8.75	5.00	0.017	0.031	0.062	X	X

I_{hold} = Hold current: maximum current device will pass without tripping in 20°C still air.
 I_{trip} = Trip current: minimum current at which the device will trip in 20°C still air.
 V_{max} = Maximum voltage device can withstand without damage at rated current (I_{max})
 I_{max} = Maximum fault current device can withstand without damage at rated voltage (V_{max})
 P_d = Power dissipated from device when in the tripped state at 20°C still air.
 R_{min} = Minimum resistance of device in initial (un-soldered) state.

R_{typ} = Typical resistance of device in initial (un-soldered) state.
 R_{1max} = Maximum resistance of device at 20°C measured one hour after tripping or reflow soldering of 260°C for 20 sec.
Caution: Operation beyond the specified rating may result in damage and possible arcing and flame.

Temperature Rerating

Part Number	Ambient Operation Temperature							
	-40°C	-20°C	0°C	20°C	40°C	50°C	60°C	70°C
12VL175XL	Hold Current (A)							
	3.5	2.9	2.4	1.75	1.3	1.0	0.8	0.3

WARNING

- Users shall independently assess the suitability of these devices for each of their applications
- Operation of these devices beyond the stated maximum ratings could result in damage to the devices and lead to electrical arcing and/or fire
- These devices are intended to protect against the effects of temporary over-current or over-temperature conditions and are not intended to perform as protective devices where such conditions are expected to be repetitive or prolonged in duration
- Exposure to silicon-based oils, solvents, electrolytes, acids, and similar materials can adversely affect the performance of these PPTC devices
- These devices undergo thermal expansion under fault conditions, and thus shall be provided with adequate space and be protected against mechanical stresses
- Circuits with inductance may generate a voltage (L di/dt) above the rated voltage of the PPTC device.

Average Time Current Curves

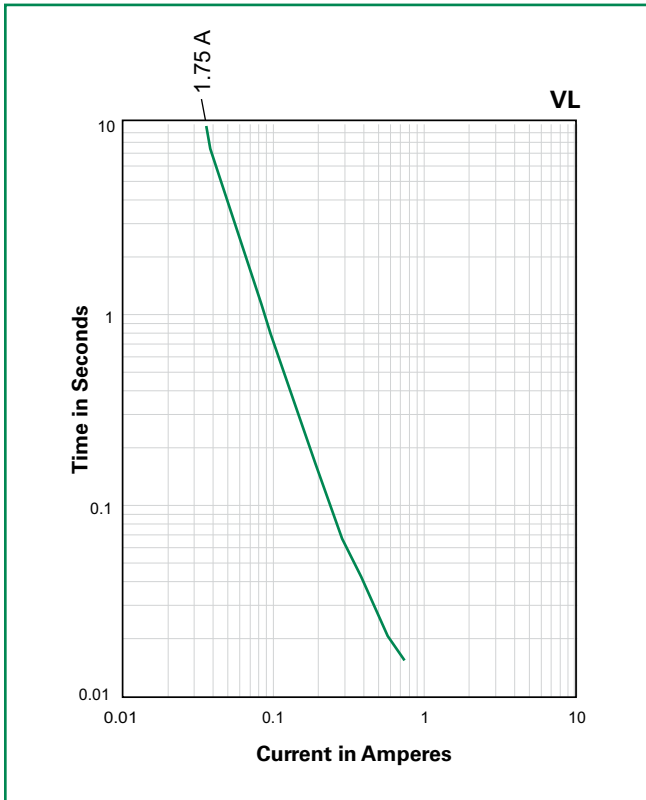

The average time current curves and Temperature Rerating curve performance is affected by a number of variables, and these curves provided as guidance only. Customer must verify the performance in their application.

Temperature Rerating Curve

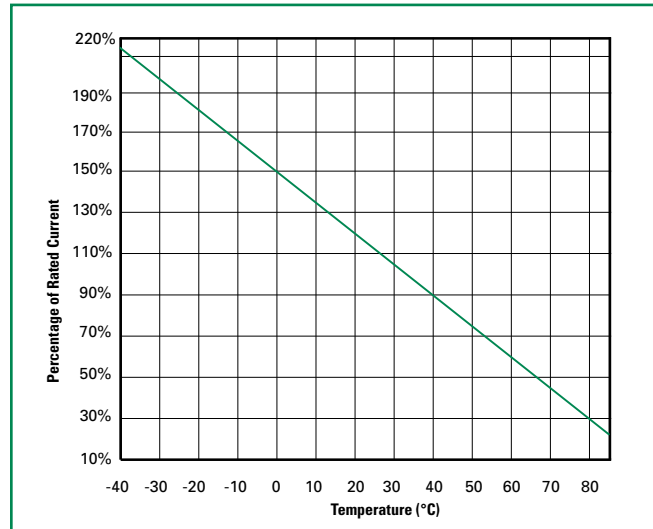

Note:
Typical Temperature rerating curve, refer to table for derating data

Physical Specifications

Terminal Material	0.13mm nominal thickness, quarter-hard Nickel
Insulating Material	Polyester tape

Environmental Specifications

Operating/Storage Temperature	-40°C to +85°C
Passive Aging	+60°C, 1000 hours -/+20% typical resistance change -40°C, 1000 hours -/+5% typical resistance change
Humidity Aging	+60°C, 95% R.H., 1000 hours, -/+10% typical resistance change
Thermal Shock	MIL-STD-202, Method 107, +85°C to -40°C 10 times -/+5% typical resistance change
Vibration	MIL-STD-883, Method 202, No change

Additional Information



Datasheet



Resources



Samples

Dimensions

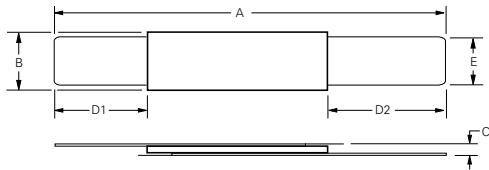

Part Number	Figure	A				B				C				D1		D2		E							
		Inches		mm		Inches		mm		Inches		mm		Inches	mm	Inches	mm	Inches	mm	Inches	mm				
		Min.	Max.	Min.	Max.	Min.	Max.	Min.	Max.	Min.	Max.	Min.	Max.	Min.	Max.	Min.	Max.	Min.	Max.	Min.	Max.				
12VL175XL	2	1.00	1.11	25.50	28.20	0.14	0.15	3.50	3.90	--	0.03	--	0.80	0.34	0.41	8.70	10.30	0.22	0.29	5.70	7.30	0.09	0.10	2.40	2.60

Part Marking System

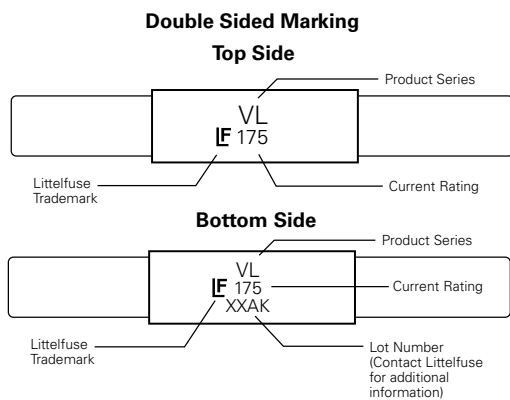

Part Ordering Number System

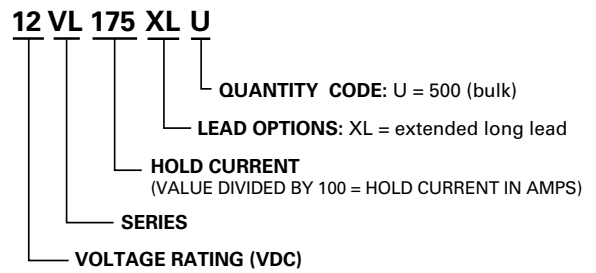

Packaging

Part Number	Ordering Number	I_{hold} (A)	I_{hold} Codes	Packaging Option	Quantity	Quantity & Packaging Codes
12VL175XL	12VL175XLU	1.75	175	Bulk	500	U

Disclaimer Notice - Information furnished is believed to be accurate and reliable. However, users should independently evaluate the suitability of and test each product selected for their own applications. Littelfuse products are not designed for, and may not be used in, all applications. Read complete Disclaimer Notice at www.littelfuse.com/disclaimer-electronics.

VT Series



Description

The new VT Series device provides reliable, noncycling protection against overcharging and short circuits events for rechargeable battery cells where resettable protection is desired.

Features

- RoHS compliant and lead-free
- Weldable Nickel terminals
- Slim, low profile design
- Compact design saves board space
- Low resistance

Applications

- Rechargeable battery cell protection
 - Mobile phones
 - Laptop computers

Agency Approvals

AGENCY	AGENCY FILE NUMBER
	E183209
	R50119583

Electrical Characteristics

Part Number	I _{hold} (A)	I _{trip} (A)	V _{max} (Vdc)	I _{max} (A)	P _d max. (W)	Maximum Time To Trip		Resistance			Agency Approvals	
						Current (A)	Time (Sec.)	R _{min} (Ω)	R _{typ} (Ω)	R _{1max} (Ω)		
16VT210S	2.10	4.70	16	100	1.5	10.00	5.00	0.018	0.030	0.060	X	X

I_{hold} = Hold current: maximum current device will pass without tripping in 20°C still air.
 I_{trip} = Trip current: minimum current at which the device will trip in 20°C still air.
 V_{max} = Maximum voltage device can withstand without damage at rated current (I_{max})
 I_{max} = Maximum fault current device can withstand without damage at rated voltage (V_{max})
 P_d = Power dissipated from device when in the tripped state at 20°C still air.
 R_{min} = Minimum resistance of device in initial (un-soldered) state.

R_{typ} = Typical resistance of device in initial (un-soldered) state.
 R_{1max} = Maximum resistance of device at 20°C measured one hour after tripping or reflow soldering of 260°C for 20 sec.
Caution: Operation beyond the specified rating may result in damage and possible arcing and flame.

Temperature Rating

Part Number	Ambient Operation Temperature									
	-40°C	-20°C	0°C	25°C	40°C	50°C	60°C	70°C	85°C	
16VT210S	Hold Current (A)									
16VT210S	4.10	3.50	2.90	2.10	1.60	1.30	1.00	0.70	0.10	

WARNING

- Users shall independently assess the suitability of these devices for each of their applications
- Operation of these devices beyond the stated maximum ratings could result in damage to the devices and lead to electrical arcing and/or fire
- These devices are intended to protect against the effects of temporary over-current or over-temperature conditions and are not intended to perform as protective devices where such conditions are expected to be repetitive or prolonged in duration
- Exposure to silicon-based oils, solvents, electrolytes, acids, and similar materials can adversely affect the performance of these PPTC devices
- These devices undergo thermal expansion under fault conditions, and thus shall be provided with adequate space and be protected against mechanical stresses
- Circuits with inductance may generate a voltage (L di/dt) above the rated voltage of the PPTC device.

Average Time Current Curves

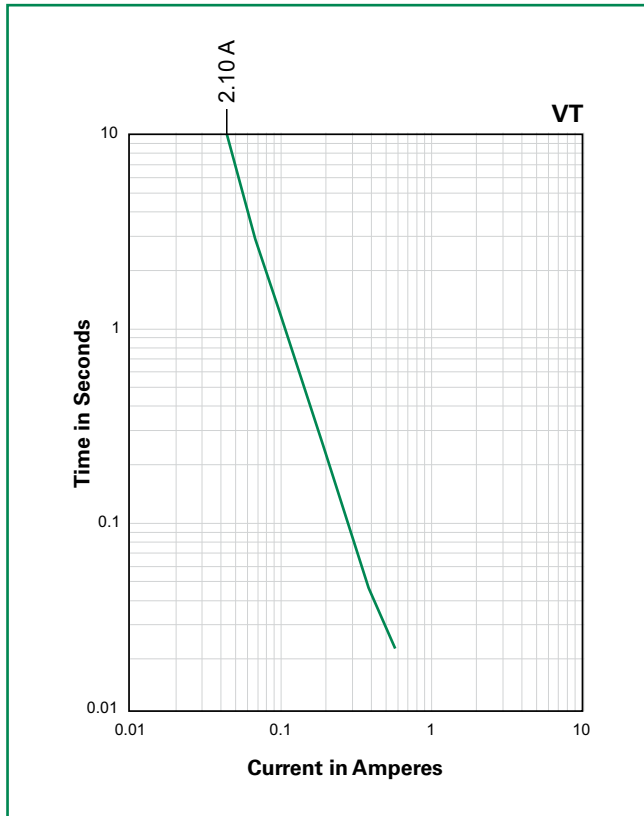

The average time current curves and Temperature Rerating curve performance is affected by a number of variables, and these curves provided as guidance only. Customer must verify the performance in their application.

Temperature Rerating Curve

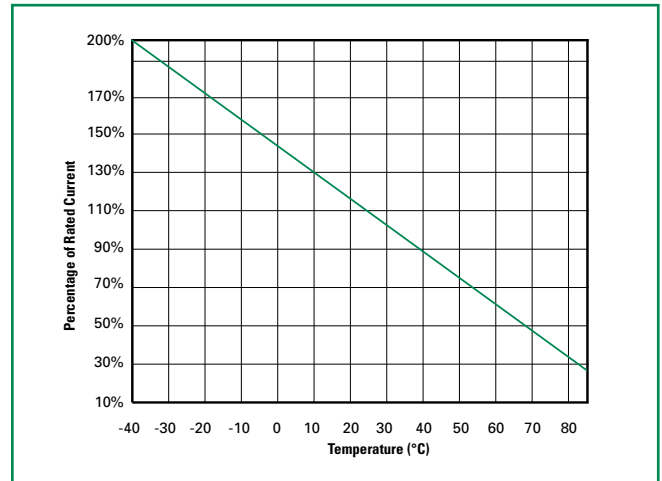

Note:
Typical Temperature rerating curve, refer to table for derating data

Physical Specifications

Terminal Material	0.13mm nominal thickness, quarter-hard Nickel
Insulating Material	Polyester tape

Environmental Specifications

Operating/Storage Temperature	-40°C to +85°C
Passive Aging	+70°C, 1000 hours, +/-10% typical resistance change
Humidity Aging	+85°C, 85% R.H., 7 days, +/-5% typical resistance change
Thermal Shock	MIL-STD-202, Method 107, +85°C/-40°C 20 times -30% typical resistance change
Vibration	MIL-STD-883, Method 2007, Condition A, No change

Additional Information



Datasheet



Resources



Samples

Dimensions

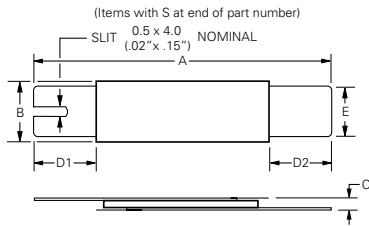

Part Number	A				B				C				D1		D2		E							
	Inches		mm		Inches		mm		Inches		mm		Inches	mm	Inches	mm	Inches	mm	Inches	mm				
	Min.	Max.	Min.	Max.	Min.	Max.	Min.	Max.	Min.	Max.	Min.	Max.	Min.	Max.	Min.	Max.	Min.	Max.	Min.	Max.				
16VT210S	0.82	0.91	20.90	23.10	0.19	0.21	4.90	5.30	0.02	0.03	0.60	0.80	0.16	0.23	4.1	5.8	0.16	0.23	4.1	5.8	0.15	0.16	3.90	4.10

Part Marking System

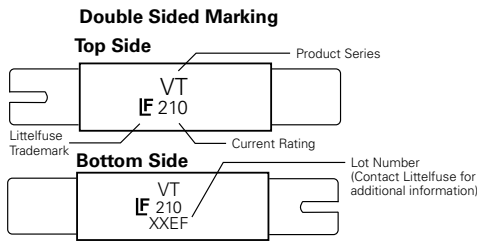

Part Ordering Number System

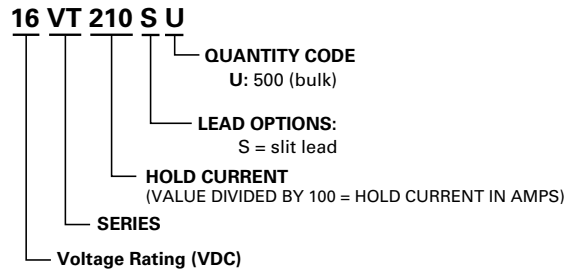

Packaging

Part Number	Ordering Number	I_{hold} (A)	I_{hold} Code	Packaging Option	Quantity	Quantity & Packaging Codes
16VT210S	16VT210SU	2.10	210	Bulk	500	U

Disclaimer Notice - Information furnished is believed to be accurate and reliable. However, users should independently evaluate the suitability of and test each product selected for their own applications. Littelfuse products are not designed for, and may not be used in, all applications. Read complete Disclaimer Notice at www.littelfuse.com/disclaimer-electronics.



Expertise Applied | Answers Delivered

littelfuse.com
circuitprotection@littelfuse.com