

The initial stage of solid state electronics into the automobile began with discrete power devices and IC components. These were to be found in the alternator rectifier, the electronic ignition system and the voltage regulator. This was followed by digital ICs and microprocessors, which are common in engine controls and trip computers. The usage of intelligent power devices and memories is common, benefiting improved electronic controls and shared visual displays. With the extensive use of electronic modules in today's vehicles, protection from transient overvoltages is essential to ensure reliable operation.

## Transient Environment

As the control circuitry in the automobile continues to develop, there is a greater need to consider the capability of new technology in terms of survivability to the commonly encountered transients in the automotive environment. The circuit designer must ensure reliable circuit operation in this severe transient environment. The transients on the automobile power supply range from the severe, high energy, transients generated by the alternator/regulator system to the low-level "noise" generated by the ignition system and various accessories. A standard automotive electrical system has all of these elements necessary to generate undesirable transients (Figure 1).

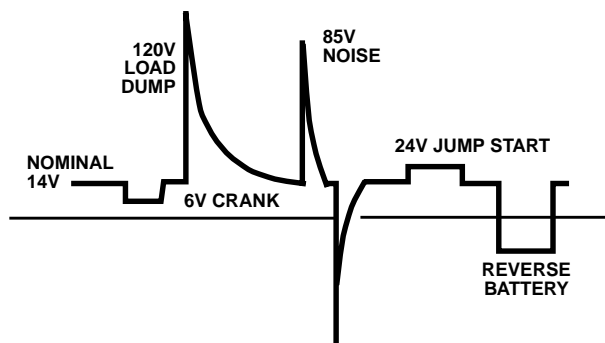

FIGURE 1. TYPICAL AUTOMOTIVE TRANSIENTS

Unlike other transient environments where external influences have the greatest impact, the transient environment of the automobile is one of the best understood. The severest transients result from either a load dump condition or a jump start overvoltage condition. Other transients may also result from relays and solenoids switching on and off, and from fuses opening.

### Load Dump

The load dump overvoltage is the most formidable transient encountered in the automotive environment. It is an exponentially decaying positive voltage which occurs in the

event of a battery disconnect while the alternator is still generating charging current with other loads remaining on the alternator circuit at the time of battery disconnect. The load dump amplitude depends on the alternator speed and the level of the alternator field excitation at the moment of battery disconnection. A load dump may result from a battery disconnect resulting from cable corrosion, poor connection or an intentional battery disconnect while the car is still running.

Independent studies by the Society of Automotive Engineers (SAE) have shown that voltage spikes from 25V to 125V can easily be generated [1], and they may last anywhere from 40ms to 400ms. The internal resistance of an alternator is mainly a function of the alternator rotational speed and excitation current. This resistance is typically between 0.5Ω and 4Ω (Figure 2).

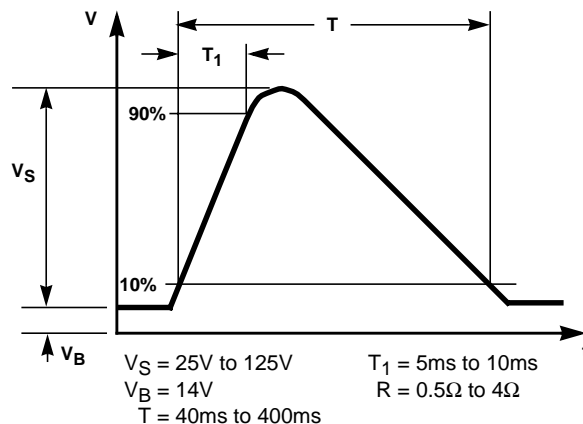

FIGURE 2. LOAD DUMP TRANSIENT

### Jump Start

The jump start transient results from the temporary application of an overvoltage in excess of the rated battery voltage. The circuit power supply may be subjected to a temporary overvoltage condition due to the voltage regulator failing or it may be deliberately generated when it becomes necessary to boost start the car. Unfortunately, under such an application, the majority of repair vehicles use 24V "battery" jump to start the car. Automotive specifications call out an extreme condition of jump start overvoltage application of up to 5 minutes.

The Society of Automotive Engineers (SAE) has defined the automotive power supply transients which are present in the system.

Table 1 shows some sources, amplitudes, polarity, and energy levels of the generated transients found in the automotive electrical system [4].

TABLE 1. TYPICAL AUTOMOTIVE TRANSIENTS

| LENGTH OF TRANSIENT | CAUSE  | ENERGY CAPABILITY    | FREQUENCY OF OCCURRENCE                  |
|---------------------|--|----------------------|--|
|                     |  | VOLTAGE AMPLITUDE    |  |
| Steady State        | Failed voltage regulator                                   | •<br>+18V            | Infrequent                               |
| 5 Minutes           | Jump starts with 24V battery                               | •<br>±24V            | Infrequent                               |
| 200ms to 400ms      | Load dump; disconnection of battery while at high charging | >10J<br><125V        | Infrequent                               |
| < 320µs             | Inductive-load switching transient                         | <1J<br>300V to +80V  | Often                                    |
| 200ms               | Alternator field decay                                     | <1J<br>-100V to -40V | Each Turn-Off                            |
| 90ms                | Ignition pulse, battery disconnected                       | <0.5J<br><75V        | < 500Hz<br>Several Times in Vehicle Life |
| 1ms                 | Mutual coupling in harness                                 | <1J<br><200V         | Often                                    |
| 15µs                | Ignition pulse, normal                                     | <0.001J<br>3V        | < 500Hz<br>Continuous                    |
| Burst               | Accessory noise  | <1.5V                | 50Hz to 10kHz                            |
| Burst               | Transceiver feedback                                       | ≈20mV                | R.F.                                     |
| <50ns               | ESD  | <10mJ<br>15kV        | Infrequent/Rand<br>om                    |

The achievement of maximum transient protection involves many factors. First, consequences of a failure should be determined. Current limiting impedances and noise immunities need to be considered. The state of the circuit under transient conditions (on, off, unknown) and the availability of low cost components capable of withstanding the transients are other factors. Furthermore, the interaction of other parts of the automotive electrical system with the circuit under transient conditions may require definition.

**Protection by a Central Suppressor**

A central suppressor was the principal transient suppression device in a motor vehicle. As such, it is connected directly across the main power supply line without any intervening load resistance. It must absorb the entire available load dump energy, and withstand the full jump-start voltage. To be cost effective, it usually is best located in the most critical electronic module. In newer applications additional suppressors may be placed at other sites for further suppression and to control locally-generated transients.

The load dump energy available to the central suppressor in the worst case depends on variables such as the alternator size, the response of the sampled-data regulator system, and the loads that share the surge current and energy. Each application therefore tends to be somewhat different. However, by combining several applications, it is possible to construct a representative example. The key fact is the alternator surge power available to be dissipated in the suppressor. Figure 3A is suggested as a starting point for analysis. Since a peak surge power of 1600W is available, a suppressor with a clamping voltage of 40V would draw a peak current of 40A. The surge energy rating needed for the suppressor can be found by taking the integral of the surge power over time, resulting in approximately 85J. A jump-start rating of 24V is also needed.

Evaluating central suppressor devices can be simplified with the aid of a load dump simulator as shown in Figure 3B. The inductor L, which simulates the alternator inductance, slows the surge rise time but does not materially affect the analysis. In the absence of a suppressor or load, the output waveform will be similar to that of Figure 1B. If a suppressor is inserted, the operating characteristics can be estimated as follows:

Assume  $V_C = 40V$ , then  $I_P = (80 - 40V)/R_1 = 40A$

The energy W dissipated in the varistor may be estimated by:  $W = 1.4V_C I_P \tau$  (see AN9771 on Energy). The impulse duration  $\tau$ , of the surge current (see AN9767, Figure 21) can be estimated from the delay time as:

$\tau = 0.7RC_1$

where R is the series-parallel combination of the effective resistance of the varistor and simulator components  $R_1$  and  $R_2$ . To facilitate this calculation, assume that the effective resistance is given by  $V_C / 0.7 I_P = 1.4\Omega$ . The delay time constant with the suppressor in the circuit then becomes:

$RC_1 = \left(\frac{2.4 \times 7}{2.4 + 7}\right)(0.03) = 0.054s$

and the surge impulse duration:

$\tau = 0.7 RC_1 = 0.038s$

The deposited energy now can be estimated by:

$W = 1.4 V_C I_P \tau = (1.4)(40)(40)(.038) = 85J$

Hence, the simulator produces unprotected and protected circuit conditions similar to those expected in the vehicle itself.

A suppressor with the needed high energy capability has been developed and already is in use. This improved Harris Varistor model V24ZA50 has a load dump rating of 100J. A narrow-tolerance selection can satisfy the clamping requirement of 40V maximum at 40A, with a jumpstart rating of 24V. The protective performance of this suppressor can be measured conveniently using the simulator circuit shown in Figure 3B.

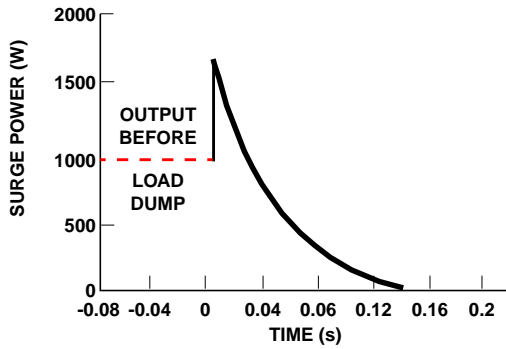

FIGURE 2A. ALTERNATOR POWER OUTPUT INTO A CENTRAL SUPPRESSOR

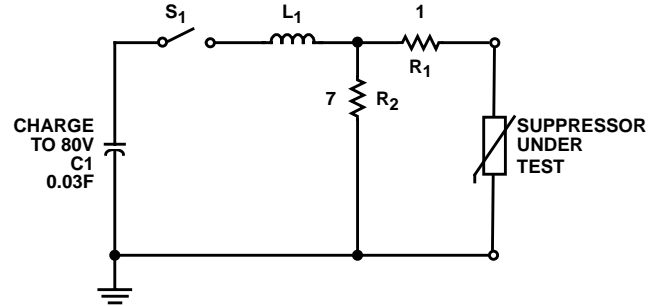

FIGURE 2B. LOAD DUMP SIMULATOR CIRCUIT

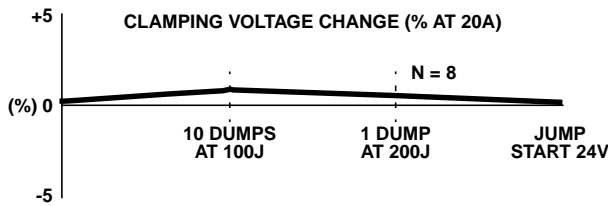

FIGURE 2C. STABILITY OF CLAMPING VOLTAGE

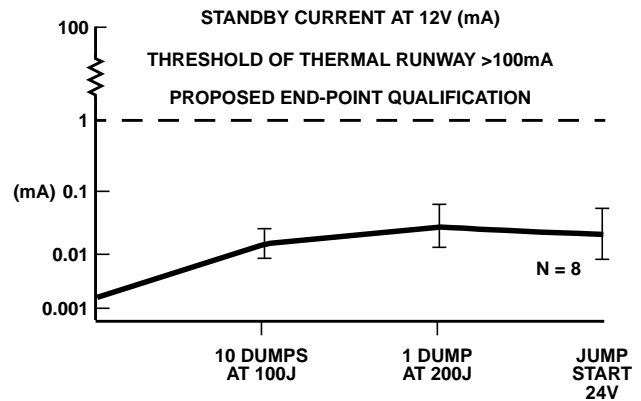

FIGURE 2D. STABILITY OF STANDBY CURRENT

### Suppressor Applications [3]

The sensitive electronics of the automobile need to be protected from both repetitive and random transients. In an environment of random transients, the dominating constraints are energy and clamping voltage vs standby power dissipation. For repetitive transients, transient power dissipation places an additional constraint on the choice of suppression device.

It must also be noted that the worst case transient scenarios, load dump and jump start, place conflicting constraints on the automotive suppressor. The high energy content of the load dump transient must be clamped to a worst case voltage of 40V, while the leakage current/power dissipation drawn under a jump start condition must also be kept to a minimum.

A centrally located suppressor is the principal transient suppression device used in most automobiles. It is connected directly across the main power supply line without any intervening load resistance. It must be capable of absorbing the entire available load dump energy, and must also withstand the full jump start voltage. To be cost effective, it is usually located in the most critical electronic module. Additional secondary suppression is also employed

at other locations in the system for further suppression and to control locally generated transients.

As previously mentioned, the maximum load dump energy available to the central suppressor depends on a combination of the alternator size and the loads that share the surge current and energy which are thus generated. It must be remembered that there are many different automotive electronic configurations which result in a variety of diverse load dumps.

### Multilayer Transient Voltage Surge Suppressor (AUML) [4, 5]

The new automotive multilayer (AUML) transient voltage suppressor is a voltage dependent, nonlinear device. It has an electrical behavior similar to that of a back-to-back zener diodes and it is inherently bidirectional. It offers protection from transients in both the forward and reverse directions. When exposed to high voltage transients, the AUML undergoes a nonlinear impedance change which is many orders of magnitude, from approximately  $10^9$  to  $10\Omega$ .

The crystalline structure of the AUML transient voltage suppressor consists of a matrix of fine, conductive grains separated by uniform grain boundaries, forming P-N

junctions (Figure 4). These boundaries are responsible for blocking conduction at low voltages, and are the source of the nonlinear electrical conduction at higher voltages. Conduction of the transient energy takes place between the millions of P-N junctions present in the device. The uniform crystalline grains act as heat sinks for the energy absorbed by the device under a transient condition, and ensures an even distribution of the transient energy (heat) throughout the device. This even distribution results in enhanced transient energy capability and long term reliability.

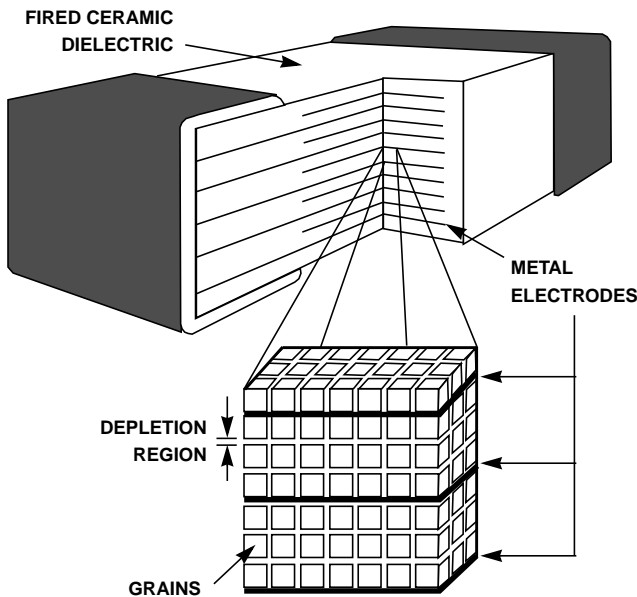

FIGURE 3. AUML TRANSIENT VOLTAGE SUPPRESSOR

The AUML is constructed by forming a combination of alternating electrode layers and semiconducting ceramic layers into a rectangular block. Each alternate layer of electrode material, separated by ceramic semiconducting material, is connected to opposite end terminations of the device.

The paralleled arrangement of the inner electrode layers represents significantly more active surface area than the small outline of the package may suggest (Figure 5). This increased active surface area, combined with an interdigitated block formation, results in proportionally higher peak energy capability.

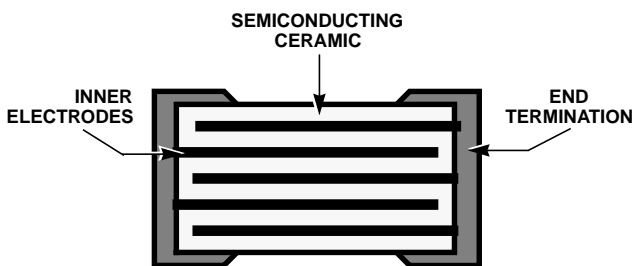

FIGURE 4. AUML INNER CONSTRUCTION

The AUML surge suppressor is a surface mountable device that is much smaller in size than the components it is designed to protect. The present size offerings for suppression in the automotive environment are "1210" (0.120 x 0.100 inches), "1812" (0.180 x 0.120 inches) and "2220" (0.220 x 0.200 inches). The correct device to use depends on the location of the suppressor in the overall electronics system.

## Device Ratings and Characteristics

### Package Outline

The present size offerings of the AUML series are the industry 2220, 1812 and 1210 standard form factors. Since the AUML device is inherently bidirectional, symmetrical orientation for placement on a printed circuit board is not a concern. Its robust construction makes it ideally suitable to endure the thermal stresses involved in the soldering, assembling and manufacturing steps involved in surface mount technology. The AUML device is inherently passivated by means of the fired ceramic material. They will not support combustion and are thus immune to the risk of flammability which may be present in the plastic or epoxy molded diode devices.

### Load Dump Energy Capability

The most damaging classification of transients an automobile must survive is a load dump discharge occurrence. A load dump transient occurs when the alternator load in the automobile is abruptly reduced and the battery clamping effect is thus removed. The worst case scenario of the load dump occurs when the battery is disconnected while operating at full rated load. The resultant load dump energy handling capability serves as an excellent figure of merit for the AUML suppressor.

Standard load dump specifications require a device capability of 10 pulses at rated energy, across a temperature range of -40°C to 125°C. This capability requirement is well within the ratings of all of the AUML series.

Due to the assortment of electronic applications in an automotive circuit, there is a need for a wide range of surge suppressors. The transient environment can generally be divided into three distinct sections and there will be a need for a different type of suppressor within each section. The 2220 size was designed for operation in the primary transient area, i.e., directly across the alternator. The 1812 size for secondary protection and the 1210 size for tertiary protection. A typically load dump transient results in an energy discharge of approximately 100J (depending on the size of the alternator). The deciding factor in the selection of the correct size suppressor is the amount of energy which is dissipated in the series and parallel loads in the circuit. The higher the impedance between the battery and the system requiring suppression, the smaller is the suppressor required.

Random samples of the 1210, 1812 and 2220 devices were subjected to repetitive load dump pulses at their rated energy level. This testing was performed across a temperature

spectrum from -40°C to 125°C. This temperature range simulates both passenger compartment and under the hood operation. There was virtually no change in the device characteristics of any of the units tested (Figure 6).

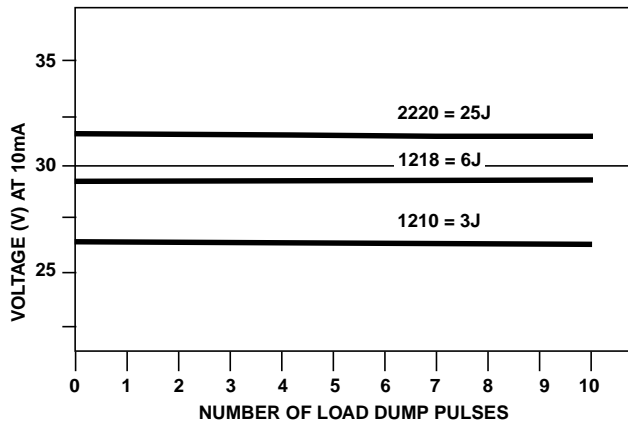

FIGURE 5. LOAD DUMP PULSING OVER A TEMPERATURE RANGE OF - 55°C TO 125°C

Further testing on the AUML series has resulted in the extension the number of load dump pulses, at rated energy, which are applied to the devices. The reliability information thus generated gives an indication of the inherent capability of the series of devices. The V18AUMLA1210 sample has been subjected to over 2000 pulses at its rated energy of 3J; the V18AUMLA1812 sample over 1000 times at 6J. The V18AUMLA2220 sample has been pulsed at 25J over 300 times (Figure 7). In all cases there has been little or no change in the device characteristics.

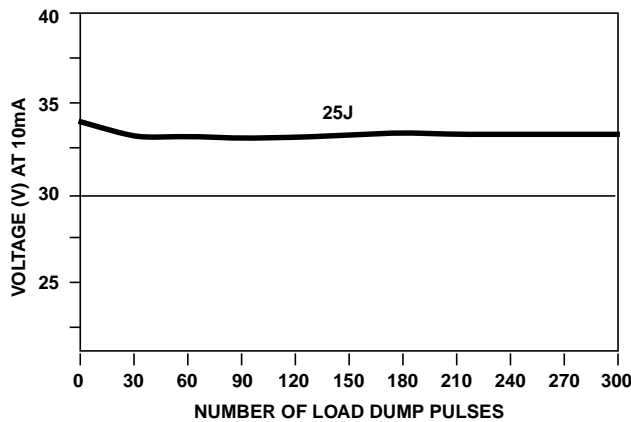

FIGURE 6. REPETITIVE LOAD DUMP PULSING AT RATED LOAD DUMP ENERGY

As previously discussed, the very high energy absorption capability of the AUML suppressor series is achieved by means of a new, highly controlled manufacturing process. This new multilayer technology ensures that a large volume of suppressor material, with an interdigitated layer construction, is available in an extremely small package.

Unlike equivalent rated silicon TVS diodes, all of the AUML device package is available to act as an effective, uniform heat sink. Hence, the peak temperatures generated by the load dump transient are evenly dissipated throughout the complete device. This even energy dissipation ensures that there are lower peak temperatures generated at the P-N grain boundaries of the AUML suppressor.

Experience has shown that while the effects of a load dump transient are of real concern, its frequency of occurrence is much less than that of localized low energy inductive spikes. Such low energy spikes may be generated as a result of motors turning on and off, from ESD occurrences, or from any number of other sources. It is essential that the suppression technology selected also has the capability to suppress such transients. Testing on the V18AUMLA2220 has shown that after being subjected to a repetitive energy pulse of 2J, over 6000 times, no characteristic changes have occurred (Figure 8).

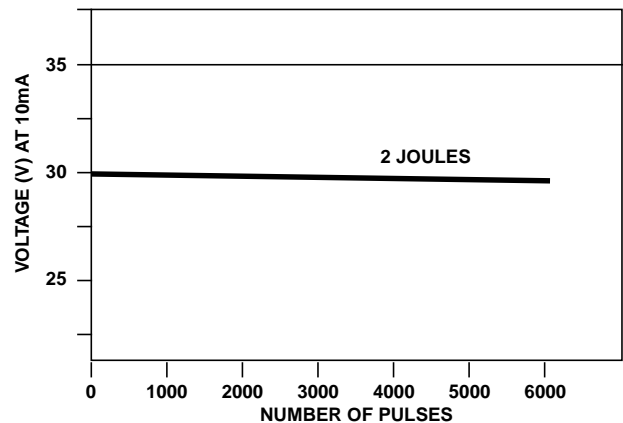

FIGURE 7. REPETITIVE ENERGY TESTING OF THE V18AUMLA2220 AT LOW ENERGY LEVELS

### Clamping Voltage

The clamping voltage of a suppressor is the peak voltage appearing across the device when measured under conditions of a specified current pulse waveform. The industry recommended waveform for clamping voltage is the 8/20µs pulse which has been endorsed by UL, IEEE and ANSI. The maximum clamping voltage of the AUML should be below the system or component failure level. Shunt type suppressors like the AUML are used in parallel to the systems they protect. Their effectiveness can be increased by understanding the important influence that source and line impedance play in the overall system (Figure 9).

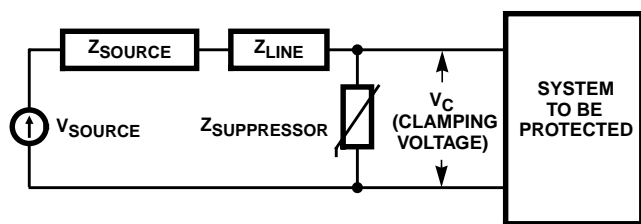

FIGURE 8. VOLTAGE DIVISIONS BETWEEN SOURCE, LINE AND SUPPRESSOR IMPEDANCE

To obtain the lowest clamping voltage ( $V_C$ ) possible, it is desirable to use the lowest suppressor impedance ( $Z_{SUPPRESSOR}$ ) and the highest line impedance ( $Z_{LINE}$ ). The suppressor impedance is an inherent feature used to select the device, but the line impedance can become an important factor in selecting the location of the suppressor by adding resistances or inductances in series.

$$V_C = \frac{V_{SUPPRESSOR} \times V_{SOURCE}}{Z_{SUPPRESSOR} + Z_{LINE} + Z_{SOURCE}}$$

### Speed of Response

The clamping action of the AUML suppressor depends on a conduction mechanism similar to that of other semiconductor devices (i.e., the P-N Junction). The apparent slow response time often associated with transient suppressors is due to parasitic inductance in the package and leads of the device, and is independent of the conducting material. The most critical element affecting the response time of a suppressor is the inductance of the lead material and hence the lead length.

The AUML suppressor is a surface mount device with no leads or external packaging, and thus, virtually zero inductance. The response time of a AUML surge suppressor is in the 1ns to 5ns range, which is more than sufficient for the transients which are encountered in the automotive environment.

### Temperature Effects

In the off-state (leakage) region of the multilayer suppressor, the device characteristics approach a linear (ohmic) relationship and shows a temperature dependent affect. In this region the suppressor is in a very high resistance mode (approaching  $10^6\Omega$ ) and appears as a near open circuit. Leakage currents at maximum rated voltage are in the low microamp range. When suppressing transients at higher currents (at and above the ten milliamp range), the AUML suppressor approaches a near short-circuit. In this region the characteristics of the AUML are virtually temperature independent. The clamping voltage of a multilayer transient voltage suppressor are the same at  $-55^\circ\text{C}$  and  $125^\circ\text{C}$  (Figure 10).

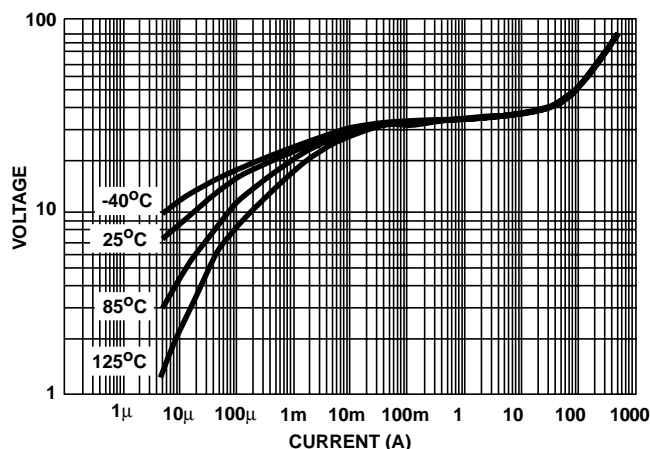

FIGURE 9. TYPICAL V - I CHARACTERISTICS OF THE V18AUMLA2220 AT  $-40^\circ\text{C}$ ,  $25^\circ\text{C}$ ,  $85^\circ\text{C}$  AND  $125^\circ\text{C}$

### Soldering Recommendations for Multilayer Surge Suppressors [6]

When soldering all surface mount components onto printed circuit boards there are certain materials, parameters and processes which must be considered. These include:

1. Printed Circuit Board Material
2. Flux used
3. Land Pad Size
4. Soldering Methods
  - 4.1 Infrared Reflow Solder
  - 4.2 Vapor Phase Solder
  - 4.3 Wave Solder
5. Cleaning Methods and Fluids Employed

### Substrates

There are a wide choice of substrate materials available for use as printed circuit boards in a surface mount application. The main factors which determine the choice of material to use are:

1. Electrical Performance
2. Size and Weight Limitations
3. Thermal Characteristics
4. Mechanical Characteristics
5. Cost

When choosing a substrate material, the coefficient of thermal expansion for the ML surface mountable suppressor of  $6\text{ppm}/^\circ\text{C}$  is an important consideration. Non-organic materials (ceramic based substrates), like aluminum or beryllia, which have coefficients of thermal expansion of  $5\text{ppm} - 7\text{ppm}/^\circ\text{C}$ , are a good match. Table 2 below outlines some of the other materials used, and also there more important properties pertinent to surface mounting.

While the choice of substrate material should take note of the coefficient of expansion of the devices, this may not be the determining factor in whether a device can be used or not. Obviously the environment of the finished circuit board will determine what level of temperature cycling will occur. It is this which will dictate the critically of the match between device and printed circuit board. Currently for most applications the ML series use FR4 boards without issue.

**TABLE 2. SUBSTRATE MATERIAL PROPERTIES**

| SUBSTRATE STRUCTURE         | MATERIAL PROPERTIES               |  |                              |
|-----------------------------|-----------------------------------|--|------------------------------|
|                             | GLASS TRANSITION TEMPERATURE (°C) | XY COEFFICIENT OF THERMAL EXPANSION (PPM/°C) | THERMAL CONDUCTIVITY (W/M°C) |
| Epoxy Fiberglass FR4        | 125                               | 14 - 18                                      | 0.16                         |
| Polyamide Fiberglass        | 250                               | 12 - 16                                      | 0.35                         |
| Epoxy Aramid Fiber          | 125                               | 6 - 8  | 0.12                         |
| Fiber/Teflon Laminates      | 75                                | 20   | 0.26                         |
| Aluminum-Beryllia (Ceramic) | Not Available                     | 5 - 7  | 21.0                         |

### Fluxes

Fluxes are used for the chemical cleaning of a substrate surface. They will remove any surface oxides, and will also prevent reoxidation. They can contain active ingredients such as solvents for removing soils and greases. Nonactivated fluxes ("R" type) are relatively effective in reducing oxides of copper or palladium/silver metallizations and are recommended for use with the Harris surface mount suppressor range.

Mildly activated fluxes ("RMA" type) have natural and synthetic resins, which reduce oxides to metal or soluble salts. These "RMA" fluxes are generally not conductive nor corrosive at room temperature and are the most commonly used in the mounting of electronic components.

The "RA" type (fully activated) fluxes are corrosive, difficult to remove, and can lead to circuit failures and other problems. Other nonresin fluxes depend on organic acids to reduce oxides. They are also corrosive after soldering and also can damage sensitive components. Water soluble types in particular must be thoroughly cleaned from the assembly.

Environmental concerns, and associated legislation, has led to a growing interest in fluxes with residues that can be removed with water or water and detergents (semiaqueous cleaning). Many RMA fluxes can be converted to water soluble forms by adding saponifiers. There are detergents and semiaqueous cleaning apparatus available that

effectively remove most RMA type fluxes. Semiaqueous cleaning also tends to be less expensive than solvent cleaning in operations where large amounts of cleaning are needed.

For the Harris Suppression Products range of surface mount varistors, nonactivated "R" type fluxes such as Alpha 100 or equivalent are recommended.

### Land Pad Patterns

Land pad size and patterns are one of the most important aspects of surface mounting. They influence thermal, humidity, power and vibration cycling test results. Minimal changes (even as small as 0.005 inches) in the land pad pattern have proven to make substantial differences in reliability.

This design /reliability relationship has been shown to exist for all types of designs such as in J-lead, quadpacks, chip resistors, capacitors and small outline integrated circuit (SOIC) packages. Optimum and tested land pad dimensions are provided for some surface mounted devices along with formulas which can be applied to different size varistors. Figure 11 gives optimum land patterns for the direct mount multilayer devices, while Table 3 outlines the optimum size of the land pad for each device size.

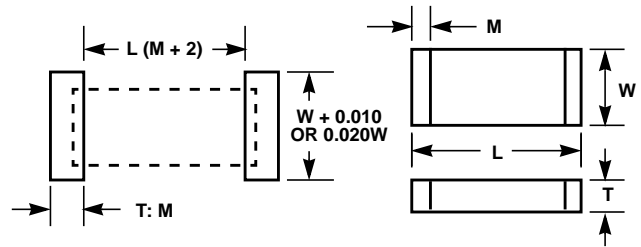

**FIGURE 10. LAND PAD PATTERNS FOR MULTILAYER SUPPRESSORS**

**TABLE 3. RECOMMENDED MOUNTING PAD OUTLINE**

| SUPPRESSOR SIZE | DIMENSION |        |                  |
|-----------------|-----------|--------|------------------|
|                 | T + M     | L - 2M | W+0.01 OR 0.02*W |
| 1206            | 1.65      | 1.85   | 2.62             |
| 1210            | 1.85      | 1.85   | 3.73             |
| 1812            | 1.85      | 3.20   | 4.36             |
| 2220            | 1.84      | 4.29   | 6.19             |

### Solder Materials and Soldering Temperatures

No varistor should be held longer than necessary at an elevated temperature. Exceeding the temperature and time limits can result in excessive leakage and alterations of the I-V characteristics.

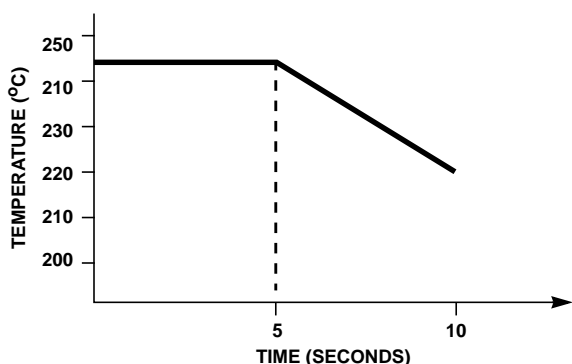

FIGURE 11. RECOMMENDED TIME AND SOLDER TEMPERATURE

To ensure that there is no leeching of the silver electrode on the varistor, solders with at least 2% silver content are recommended (62 Sn / 36 Pb / 2 Ag). Examples of silver bearing solders and their associated melting temperatures are per Table 4.

TABLE 4. SILVER BEARING SOLDERS (ALPHA METALS)

| ALLOY         | MELTING TEMPERATURE |           |
|---------------|---------------------|-----------|
|               | °F                  | °C        |
| 62Sn/36Pb/2Ag | 355                 | 179       |
| 96.5Sn/3.5Ag  | 430                 | 221       |
| 95Sn/5Ag      | 430 - 473           | 221 - 245 |
| 20Sn/88Pb/2Ag | 514 - 576           | 268 - 302 |

**Soldering Methods**

There are a number of different soldering techniques used in the surface mount process. The most common soldering processes are infra red reflow, vapor phase reflow and wave soldering.

For the Harris surface mount suppressor range, the solder paste recommended is a 62/36/2 silver solder. While this configuration is best, other silver solder pastes can also be used. In all soldering applications, the time at peak temperature should be kept to a minimum. Any temperature steps employed in the solder process must, in broad terms, not exceed 70°C to 80°C. In the preheat stage of the reflow process, care should be taken to ensure that the chip is never subjected to a thermal gradient of greater than 4°C per second; the ideal gradient being 2°C per second. For optimum soldering, preheating to within 100°C of the peak soldering temperature is recommended; with a short dwell at the preheat temperature to help minimize the possibility of thermal shock. The dwell time at this preheat temperature should be for a time greater than 10T<sup>2</sup> seconds, where T is the chip thickness in millimeters. Once the soldering process has been completed, it is still necessary to protect against further effects of thermal shocks. One possible cause of thermal shock at the post solder stage is when the hot printed circuit boards are removed from the solder bath and immediately subjected to cleaning solvents at room

temperature. To avoid this thermal shock affect, the boards must first be allowed to cool to less than 50°C prior to cleaning.

Two different resistance to solder heat tests are routinely performed by Harris Suppression Products to simulate any possible effects that the high temperatures of the solder processes may have on the surface mount chip. These tests consist of the complete immersion of the chip in to a solder bath at 260°C for 5 seconds and also in to a solder bath at 220°C for 10 seconds. These soldering conditions were chosen to replicate the peak temperatures expected in a typical wave soldering operation and a typical reflow operation.

**Reflow Soldering**

There are two major reflow soldering techniques used in SMT today:

1. InfraRed (IR) Reflow
2. Vapor Phase Reflow

The only difference between these two methods is the process of applying heat to melt the solder. In each of these methods precise amounts of solder paste are applied to the circuit board at points where the component terminals will be located. Screen or stencil printing, allowing simultaneous application of paste on all required points, is the most commonly used method for applying solder for a reflow process. Components are then placed in the solder paste. The solder pastes are a viscous mixture of spherical solder powder, thixotropic vehicle, flux and in some cases, flux activators.

During the reflow process, the completed assembly is heated to cause the flux to activate, then heated further, causing the solder to melt and bond the components to the board. As reflow occurs, components whose terminations displace more weight, in solder, than the components weight will float in the molten solder. Surface tension forces work toward establishing the smallest possible surface area for the molten solder. Solder surface area is minimized when the component termination is in the center of the land pad and the solder forms an even fillet up the end termination. Provided the boards pads are properly designed and good wetting occurs, solder surface tension works to center component terminations on the boards connection pads. This centering action is directly proportional to the solder surface tension. Therefore, it is often advantageous to engineer reflow processes to achieve the highest possible solder surface tension, in direct contrast to the desire of minimizing surface tension in wave soldering.

In designing a reflow temperature profile, it is important that the temperature be raised at least 20°C above the melting or liquid temperature to ensure complete solder melting, flux activation, joint formation and the avoidance of cold melts. The time the parts are held above the melting point must be long enough to allow the alloy to wet, to become homogenous and to level, but not enough to cause leeching of solder, metallization or flux charring.



A fast heating rate may not always be advantageous. The parts or components may act as heat sinks, decreasing the rate of rise. If the coefficients of expansion of the substrate and components are too diverse or if the application of heat is uneven, fast breaking or cooling rates may result in poor solder joints or board strengths and loss of electrical conductivity. As stated previously, thermal shock can also damage components. Very rapid heating may evaporate low boiling point organic solvents in the flux so quickly that it causes solder spattering or displacement of devices. If this occurs, removal of these solvents before reflow may be required. A slower heating rate can have similar beneficial effects.

**InfraRed (IR) Reflow**

InfraRed (IR) reflow is the method used for the reflowing of solder paste by the medium of a focused or unfocused infra red light. Its primary advantage is its ability to heat very localized areas.

The IR process consists of a conveyor belt passing through a tunnel, with the substrate to be soldered sitting on the belt. The tunnel consists of three main zones; a non-focused preheat, a focused reflow area and a cooling area. The unfocused infrared areas generally use two or more emitter zones, thereby providing a wide range of heating profiles for solder reflow. As the assembly passes through the oven on the belt, the time/temperature profile is controlled by the speed of the belt, the energy levels of the infrared sources, the distance of the substrate from the emitters and the absorptive qualities of the components on the assembly.

The peak temperature of the infrared soldering operation should not exceed 220°C. The rate of temperature rise from the ambient condition to the peak temperature must be carefully controlled. It is recommended that no individual temperature step is greater than 80°C. A preheat dwell at approximately 150°C for 60 seconds will help to alleviate potential stresses resulting from sudden temperature changes. The temperature ramp up rate from the ambient condition to the peak temperature should not exceed 4°C per second; the ideal gradient being 2°C per second. The dwell time that the chip encounters at the peak temperature should not exceed 10 seconds. Any longer exposure to the peak temperature may result in deterioration of the device protection properties. Cooling of the substrate assembly after solder reflow is complete should be by natural cooling and not by forced air.

The advantages of IR Reflow are its ease of setup and that double sided substrates can easily be assembled. Its biggest disadvantage is that temperature control is indirect and is dependent on the IR absorption characteristics of the component and substrate materials.

On emergence from the solder chamber, cooling to ambient should be allowed to occur naturally. Natural cooling allows a gradual relaxation of thermal mismatch stresses in the

solder joints. Forced air cooling should be avoided as it can induce thermal breakage.

The recommended temperature profile for the IR reflow soldering process is as Figure 13 and Table 5.

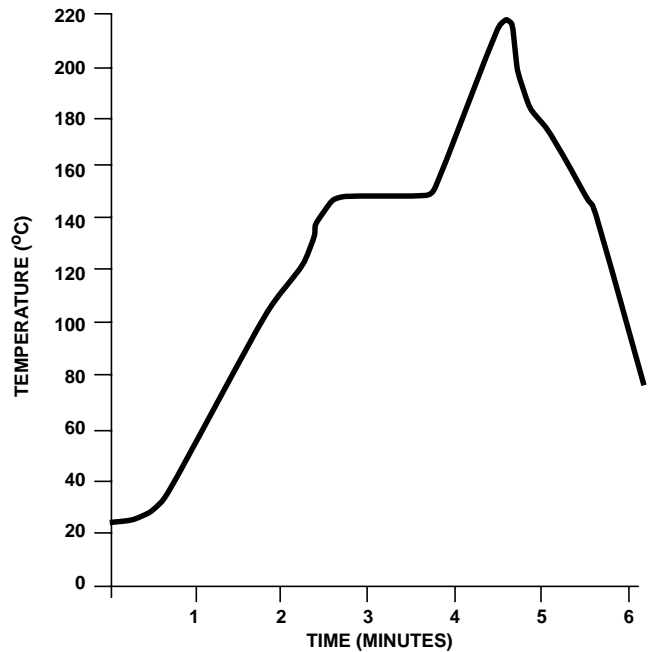

FIGURE 12. TYPICAL TEMPERATURE PROFILE FOR IR REFLOW SOLDER PROCESS

TABLE 5. RECOMMENDED TEMPERATURE PROFILE

| INFRARED (IR) REFLOW |                |
|----------------------|----------------|
| TEMPERATURE (°C)     | TIME (SECONDS) |
| 25-60                | 60             |
| 60-120               | 60             |
| 120-155              | 30             |
| 155-155              | 60             |
| 155-220              | 60             |
| 220-220              | 10             |
| 220-50               | 60             |

**Vapor Phase Reflow**

Vapor phase reflow soldering involves exposing the assembly and joints to be soldered to a vapor atmosphere of an inert heated solvent. The solvent is vaporized by heating coils or a molten alloy, in the sump or bath. Heat is released and transferred to the assembly where the vapor comes in contact with the colder parts of the substrate and then condenses. In this process all cold areas are heated evenly and no areas can be heated higher than the boiling point of the solvent, thus preventing charring of the flux. This method gives a very rapid and even heating affect. Further advantages of vapor phase soldering is the excellent control

of temperature and that the soldering operation is performed in an inert atmosphere.

The liquids used in this process are relatively expensive and so, to overcome this a secondary less expensive solvent is often used. This solvent has a boiling temperature below 50°C. Assemblies are passed through the secondary vapor and into the primary vapor. The rate of flow through the vapors is determined by the mass of the substrate. As in the case of all soldering operations, the time the components sit at the peak temperature should be kept to a minimum. In the case of Harris surface mount suppressors a dwell of no more than 10 seconds at 222°C is recommended.

On emergence from the solder system, cooling to ambient should be allowed to occur naturally. Natural cooling allows a gradual relaxation of thermal mismatch stresses in the solder joints. Forced air cooling should be avoided as it can induce thermal breakage.

The recommended temperature profile for the vapor phase soldering process is as Figure 14 and Table 6.

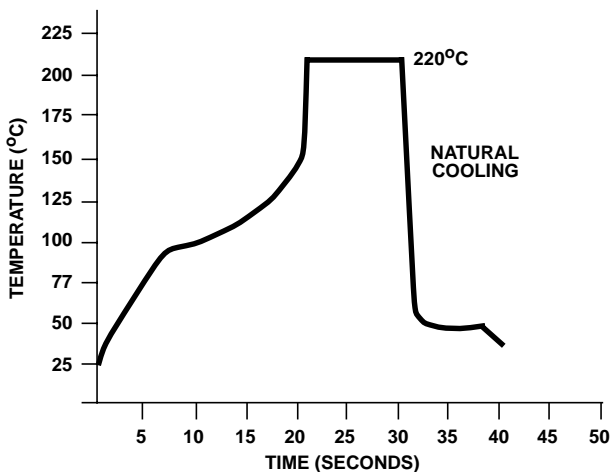

FIGURE 13. TYPICAL TEMPERATURE PROFILE FOR VAPOR PHASE REFLOW SOLDERING

TABLE 6. RECOMMENDED TEMPERATURE PROFILE

| INFRARED (IR) REFLOW |                |
|----------------------|----------------|
| TEMPERATURE (°C)     | TIME (SECONDS) |
| 25-90                | 8              |
| 90-150               | 13             |
| 150-222              | 3              |
| 222-222              | 10             |
| 222-80               | 7              |
| 80-25                | 10             |

**Wave Solder**

This technique, while primarily used for soldering thru hole or leaded devices inserted into printed circuit boards, has also been successfully adapted to accommodate a hybrid technology where leaded, inserted components and adhesive bonded surface mount components populate the same circuit board.

The components to be soldered are first bonded to the substrate by means of a temporary adhesive. The board is then fluxed, preheated and dipped or dragged through two waves of solder. The preheating stage serves many functions. It evaporates most of the flux solvent, increases the activity of the flux and accelerates the solder wetting. It also reduces the magnitude of the temperature change experienced by the substrate and components.

The first wave in the solder process is a high velocity turbulent wave that deposits large quantities of solder on all wettable surfaces it contacts. This turbulent wave is aimed at solving one of the two problems inherent in wave soldering surface mount components, a defect called voiding (i.e., skipped areas). One disadvantage of the high velocity turbulent wave is that it gives rise to a second defect known as bridging, where the excess solder thrown at the board by the turbulent wave spans between adjacent pads or circuit elements thus creating unwanted interconnects and shorts.

The second, smooth wave accomplishes a clean up operation, melting and removing any bridges created by the turbulent wave. The smooth wave also subjects all previous soldered and wetted surfaces to a sufficiently high temperature to ensure good solder bonding to the circuit and component metallizations. In wave soldering, it is important that the solder have low surface tension to improve its surface wetting characteristics. Therefore, the molten solder bath is maintained at temperatures above its liquid point.

On emergence from the solder wave, cooling to ambient should be allowed to occur naturally. Natural cooling allows a gradual relaxation of thermal mismatch stresses in the solder joints. Forced air cooling should be avoided as it can induce thermal breakage.

The recommended temperature profile for the wave soldering process is as Table 7.

TABLE 7. RECOMMENDED TEMPERATURE PROFILE

| WAVE SOLDER      |                |
|------------------|----------------|
| TEMPERATURE (°C) | TIME (SECONDS) |
| 25-125           | 60             |
| 125-180          | 60             |
| 180-260          | 60             |
| 260-260          | 5              |
| 260-180          | 60             |
| 180-80           | 60             |
| 80-25            | 60             |

**Cleaning Methods and Cleaning Fluids**

The objective of the cleaning process is to remove any contamination, from the board, which may affect the chemical, physical or electrical performance of the circuit in its working environment.

There are a wide variety of cleaning processes which can be used, including aqueous based, solvent based or a mixture of both, tailored to meet specific applications. After the soldering of surface mount components there is less residue to remove than in conventional through hole soldering. The cleaning process selected must be capable of removing any contaminants from beneath the surface mount assemblies. Optimum cleaning is achieved by avoiding undue delays between the cleaning and soldering operations; by a minimum substrate to component clearance of 0.15mm and by avoiding the high temperatures at which oxidation occurs.

Harris recommends 1,1,1 trichloroethane solvent in an ultrasonic bath, with a cleaning time of between two and five minutes. Other solvents which may be better suited to a particular application and can also be used may include those outlined in Table 8.

TABLE 8. CLEANING FLUIDS

|                          |                  |
|--------------------------|------------------|
| Water                    | Acetone          |
| Isopropyl Alcohol        | Fluorocarbon 113 |
| Fluorocarbon 113 Alcohol | N-Butyl          |
| 1,1,1, Trichloroethane   | Trichloroethane  |
| Toluene                  | Methane          |

**Comparison to Other Device Technologies**

There are many design considerations involved when selecting the correct transient suppressor for an automotive application. One obvious consideration is cost. Other factors such as load dump energy capability, clamping voltage, temperature dependence, and size must also be weighed. Each of these factors will now be discussed.

**Energy Capability**

The large active electrode area available to the AURL suppressor ensures that load dump energy handling capability is one of it's best features. By virtue of its interdigitated construction, the AURL suppressor is capable of dissipating significant amounts of energy over a very small volume of material. The interdigitated construction also ensures that the very high temperatures resulting from a load dump transient will be evenly dissipated through millions of P-N junctions.

Silicon surge suppressors may also be used for the suppression of transients in an automotive environment. In the case of a silicon suppressor, only one P-N junction is available to handle the energy of the load transient. It should be noted that many different materials, with varying thermal coefficients of expansion, are employed in the construction

of a silicon suppressor. This may result in extreme thermal stresses being created in the body of the suppressor during a load dump condition.

Comparing the typical peak current, energy and power derating curves of the Harris multilayer to an equivalent silicon suppressor at 125°C, the AURL has 100% of rated value while the zener diode has only 35% (Figure 15).

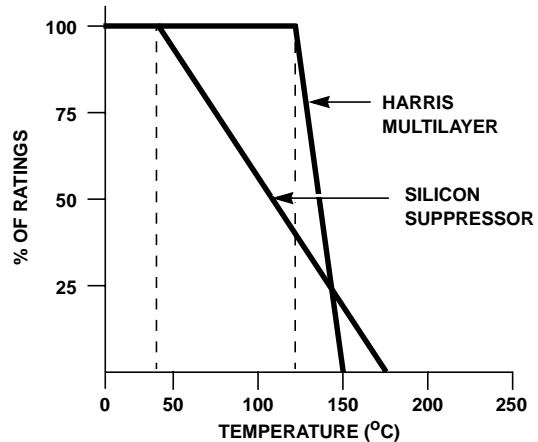

FIGURE 14. AURL AND SILICON SUPPRESSORS CURRENT, ENERGY AND POWER DERATING CURVE

**Clamping Voltage**

In the majority of automotive applications, the maximum clamping voltage requirement for the primary surge suppressor is 40V at 40A (8/20µs current waveform). Both the AURL and silicon suppressors easily meet this requirement.

The V-I characteristic for a silicon diode is defined over a small current range (1 decade). The AURL current range is extended over a few more decades, which illustrates it's large peak current and energy handling capability.

**Temperature Effects**

Both the AURL and the silicon diode have a temperature dependence with respect to off state leakage current - leakage current increases as temperature increases. However, beyond the breakdown point, the clamping voltage of the AURL will remain constant between 25°C and 125°C, while the clamping voltage for the zener diode at 125°C is higher than that specified at 25°C.

**Size**

Common surface mount surge suppressors available are leaded gull-wing and j-bend silicon diodes or a relatively large surface mount metal oxide varistor. In these cases a large area of the PC board is needed for mounting. As previously mentioned, electrically equivalent AURL suppressors are much smaller than their silicon counterparts, resulting in significant surface mount PC board area savings (Figure 16).

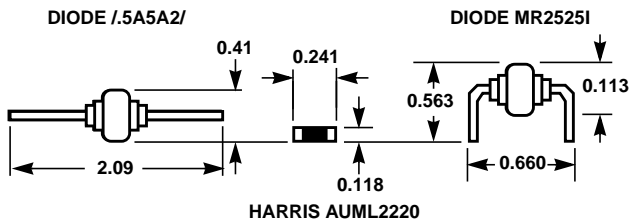

FIGURE 15. SIZE COMPARISONS OF AUTOMOTIVE SURGE SUPPRESSORS

The compact size of the AUML suppressor is obtained by the paralleled stacking manufacturing process. This results in a high density energy absorber where the device volume is not taken up by lead frames, headers, external leads, and epoxy. Additional board area savings are also realized with the smaller solder mounting area required by the AUML.

### Description of AUML Ratings and Characteristics

**Maximum Continuous DC Working Voltage ( $V_{M(DC)}$ ):** This is the maximum continuous DC voltage which may be applied, up to the maximum operating temperature (125°C), to the AUML suppressor. This voltage is used as the reference test point for leakage current and is always less than the breakdown voltage of the device.

**Load Dump Energy Rating ( $W_{ld}$ ):** A load dump occurs when the alternator load is suddenly reduced. The worst case load dump is caused by disconnecting a discharged battery when the alternator is running at full load. The load dump energy discharge occurs with the rated battery voltage also applied and must not cause device failure. This pulse can be applied to the AUML suppressor in either polarity.

**Maximum Clamping Voltage ( $V_C$ ):** This is the peak voltage appearing across the AUML suppressor when measured with an 8/20µs pulse current (Figure 17).

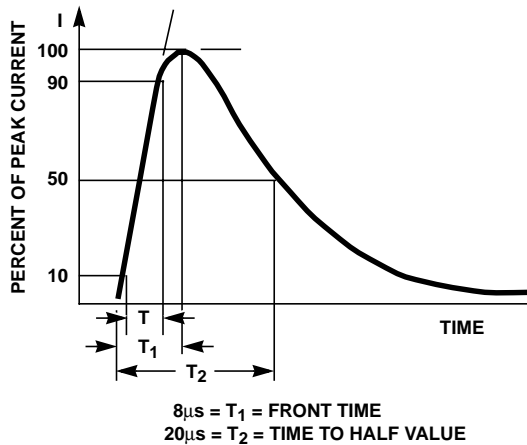

FIGURE 16.

**Leakage Current ( $I_L$ ):** This is the amount of current drawn by the AUML suppressor in its non-operational mode, i.e., when the voltage applied across the AUML does not exceed the rated  $V_{M(DC)}$  voltage of the device.

**Nominal Voltage ( $V_{N(DC)}$ ):** This is the voltage at which the AUML enters its conduction state and begins to suppress transients. In the automotive environment this voltage is defined at the 10mA point and has a minimum and maximum voltage specified.

### References

For Harris documents available on the web, see <http://www.semi.harris.com/>  
Harris AnswerFAX (407) 724-7800.

- [1] *Electromagnetic Susceptibility Measurement Procedures for Vehicle Components - SAE J1113*, August, 1987.
- [2] *Soldering Recommendations for Surface Mount Metal Oxide Varistors and Multilayer Transient Voltage Suppressors*, AN9211, Harris Suppression Products, AnswerFAX Doc. No. 99211.
- [3] *Transient Voltage Suppression Devices*, Harris Suppression Products DB450.
- [4] "Transient Suppression in the Automotive Environment", Corbett, M. and McCambridge, P., *Automotive Electronic Design*, October, 1991.
- [5] "Harris "ML" Multilayer Surface Mount Surge Suppressors", Application Note AN9108, Harris Suppression Products, AnswerFAX Doc. No. 99108.
- [6] *CANE SMT 2588*, Syfer Technology Limited, UK.

---

All Harris semiconductor products are manufactured, assembled and tested under **ISO9000** quality systems certification.

*Harris semiconductor products are sold by description only. Harris Corporation, Semiconductor Communications Division, reserves the right to make changes in circuit design and/or specifications at any time without notice. Accordingly, the reader is cautioned to verify that data sheets are current before placing orders. Information furnished by Harris is believed to be accurate and reliable. However, no responsibility is assumed by Harris or its subsidiaries for its use; nor for any infringements of patents or other rights of third parties which may result from its use. No license is granted by implication or otherwise under any patent or patent rights of Harris or its subsidiaries.*

For information regarding Harris Corporation's Semiconductor Communications Division and its products, call **1-800-4-HARRIS** or see web site <http://www.semi.harris.com>