

**ILLUSTRATED
PARTS CATALOG
FOR
O-470 AND IO-470 SERIES
AIRCRAFT ENGINES**

NOTICE

**Part numbers appearing herein are trademarks of
Teledyne Continental Motors.**

**Courtesy of Bomar Flying Service
www.bomar.biz**

CURRENT STATUS OF PAGES AS OF NOVEMBER 1975

INSERT LATEST PAGES

DESTROY SUPERSEDED PAGES

THE PAGES IN THIS PUBLICATION CONSIST OF THE FOLLOWING:

MODELS O-470-A,B,E,G,J,K,L,M,P,R & S

And

MODELS O-470-C,D,E,F,G,H,J,K,L,M,N,P,R,S,U & V

PAGE	ISSUE	PAGE	ISSUE
i thru x	Original		
1-1 thru 1-17	Original		
2-1 thru 2-114	Original		
3-1 thru 3-4	Original		
4-1 thru 4-6	Original		
5-1 thru 5-16	Original		
6-1 thru 6-24	Original		

* THE ASTERISK INDICATES PAGES CHANGED, ADDED, OR DELETED BY THE CURRENT CHANGE.

TABLE OF CONTENTS

SECTION I

INTRODUCTION	1-1
ABBREVIATIONS AND SYMBOLS	1-2
ACCESSORY MANUFACTURERS	1-2

SECTION II – GROUP ASSEMBLY PARTS LIST

Figure 1 – Crankcase Studding Assembly Models O-470-A, B, E, G, J, K, L, M, P, R, S	2-2
Figure 2 – Crankcase Studding Assembly Models IO-470-C, D, E, F, G, H, J, K, L, M, N, P, R, S, U, V	2-4
Figure 3 – Crankcase Attaching Parts Models O-470-A, B, E, G, J, K, L, M, P, R, S	2-6
Figure 4 – Crankcase Attaching Parts Models IO-470-C, D, E, F, G, H, J, K, L, M, N, P, R, S, U, V	2-8
Figure 5 – Crankcase Associated Parts Models O-470-A, B, E, G, J, K, L, M, P, R, S	2-10
Figure 6 – Crankcase Associated Parts Models IO-470-C, D, E, F, G, H, J, K, L, M, N, P, R, S, U, V	2-12
Figure 7 – Crankcase and Crankshaft Extension Assemblies Model IO-470-P	2-14
Figure 8 – Crankshaft Assembly Models O-470-A, B, E, G, J, K, L, M, P, R, S	2-16
Figure 9 – Crankshaft Assembly Models IO-470-C, D, E, F, G, H, J, K, L, M, N, P, R, S, U, V	2-18
Figure 10 – Camshaft Assembly Models O-470-A, B, E, G, J, K, L, M, P, R, S	2-20
Figure 11 – Camshaft Assembly Models IO-470-C, D, E, F, G, H, J, K, L, M, N, P, R, S, U, V	2-21
Figure 12 – Piston and Ring Assembly Models O-470-A, B, E, G, J, M, P and IO-470-C, G, J, K, P, R	2-22

SECTION II – GROUP ASSEMBLY PARTS LIST (CONTINUED)

Figure 13 – Piston and Ring Assembly Models O-470-K, L, R, S	2-23
Figure 13A – Piston and Ring Assembly Models IO-470-D, E, F, H, L, M, N, S, U, V	2-23B
Figure 14 – Cylinder Assembly Models O-470-A, E, J	2-24
Figure 15 – Cylinder Assembly Models IO-470-J, K	2-26
Figure 16 – Cylinder Assembly Models O-470-B, G, K, L, M, P, R, S	2-28
Figure 17 – Cylinder Assembly Models IO-470-C, D, E, F, G, H, L, M, N, P, R, S, U, V	2-30
Figure 18 – Connecting Rod Assembly All Models	2-32
Figure 19 – Fuel Pump, Adapter and Drive Gear Models O-470-B, E, G, M, P	2-33
Figure 20 – Oil Sump Models O-470-A, B, E, J, K, L, M, R, S and IO-470-D, E, F, G, L, M, P, R, S, U, V	2-34
Figure 21 – Oil Sump Models O-470-G, P and IO-470-C, H, J, N	2-36
Figure 22 – Oil Pump Assembly Models O-470-A, B, E, G, J, K, L, M, P, R, S	2-38
Figure 23 – Oil Pump Cover and Tachometer Drive Models O-470-A, B, E, G, J, K, L, M, P, R, S	2-40
Figure 24 – Oil Pump Assembly Models IO-470-C, D, E, F, G, H, J, K, L, M, N, P, R, S, U, V	2-42
Figure 25 – Oil Pump Cover and Tachometer Drive Models IO-470-C, D, E, F, G, H, J, K, L, M, N, P, R, S, U, V	2-44
Figure 26 – Starter and Starter Adapter Models O-470-A, B, E, G, J, K, L, M, P, R, S	2-46
Figure 27 – Starter and Starter Adapter Models IO-470-C, D, E, F, G, H, J, K, L, M, N, P, R, S, U, V	2-48
Figure 28 – Generator and Mounting Brackets Models O-470-A, B, E, G, J, K, M, P, R	2-50
Figure 29 – Generator and Mounting Brackets Models IO-470-C, D, E, F, G, H, J, K, L, N, P, R, S	2-51

SECTION II – GROUP ASSEMBLY PARTS LIST (CONTINUED)

Figure 30 – Generator and Mounting Brackets
 Model IO-470-M 2-52

Figure 31 – Generator and Mounting Brackets
 Models IO-470-U, V 2-53

Figure 32 – Alternator (Optional Equipment)
 All Models 2-54

Figure 33 – Oil Cooler
 Models O-470-A, E, J, K, and IO-470-F 2-55

Figure 34 – Oil Cooler
 Models O-470-G, L, P, R, S 2-56

Figure 35 – Oil Cooler
 Models IO-470-C, E, G, H, J, K, N, R, S 2-57

Figure 36 – Oil Cooler
 Models O-470-B, M and IO-470-D, L, M, U, V 2-58

Figure 37 – Magneto and Accessory Drives
 Models O-470-A, B, E, G, J, K, L, M, P, R, S 2-60

Figure 38 – Magneto and Accessory Drives
 Models IO-470-C, D, E, F, G, H, J, K, L, M, N, P, R, S, U, V 2-61

Figure 39 – Ignition System
 Models O-470-A, B, E, G, J, K, L, M, P, R 2-62

Figure 40 – Ignition System
 Model O-470-S 2-64

Figure 41 – Ignition System
 Models IO-470-C, E, E, F, G, H, L, M, N, P, R 2-66

Figure 42 – Ignition System
 Models IO-470-S, U, V 2-68

Figure 43 – Ignition System
 Models IO-470-J, K 2-70

Figure 44 – Ignition Cable Lead Lengths
 Models O-470-A, B, E, G, J, K, L, M, P and IO-470-C, D, E, F, G, H, L, M, N, P, R 2-72

Figure 45 – Ignition Cable, Spark Plug End
 Models O-470-A, G, P 2-73

Figure 46 – Ignition Cable, Spark Plug End
 Models O-470-B, E, J, K, L, M, R 2-74

Figure 47 – Ignition Cable, Spark Plug End
 Models IO-470-C, D, E, F, G, H, L, M, N, P, R 2-75

SECTION II – GROUP ASSEMBLY PARTS LIST (CONTINUED)

Figure 48 – Ignition Cable, Spark Plug End Models IO-470-J, K, S, U, V	2-76
Figure 49 – Priming System Models O-470-B, G, M, P	2-77
Figure 50 – Induction System Models O-470-A, J, K, L, R, S	2-78
Figure 51 – Induction System Models O-470-B, E, M	2-80
Figure 52 – Induction System Models O-470-G, P	2-82
Figure 53 – Induction System Models IO-470-C, H, J, K, N	2-84
Figure 54 – Induction System Models IO-470-D, E, G, L, P, R, U, V	2-86
Figure 55 – Induction System Models IO-470-F, S	2-88
Figure 56 – Induction System Model IO-470-M	2-90
Figure 57 – Fuel Injection System Models IO-470-C, H, J	2-92
Figure 58 – Fuel Injection System Model IO-470-F	2-94
Figure 59 – Fuel Injection System Models IO-470-K, N	2-96
Figure 60 – Fuel Injection System Model IO-470-L	2-98
Figure 61 – Fuel Injection System Model IO-470-M	2-100
Figure 62 – Fuel Injection System Model IO-470-S	2-102
Figure 63 – Fuel Injection System Models IO-470-U, V	2-104
Figure 64 – Fuel Injection System Models IO-470-D, E, G, P, R	2-106
Figure 65 – Throttle and Lever Assembly Models IO-470-C, D, E, F, G, H, J, K, L, M, N, P, R, S, U, V	2-108

SECTION II – GROUP ASSEMBLY PARTS LIST (CONTINUED)

Figure 66 – Fuel Manifold Valve
Models IO-470-C, D, E, F, G, H, J, K, L, M, N, P, R, S, U, V 2-110

Figure 67 – Fuel Pump and Vapor Separator Fitting Locations
Models IO-470-C, D, E, F, G, H, J, K, L, M, N, P, R, S, U, V 2-111

Figure 68 – Fuel Manifold Valve Fitting Locations
Models IO-470-C, D, E, F, G, H, J, K, L, M, N, P, R, S, U, V 2-112

Figure 69 – Fuel Control Fitting Locations
Models IO-470-C, D, E, F, G, H, J, K, L, M, N, P, R, S, U, V 2-113

SECTION III – OVERSIZE AND UNDERSIZE PARTS LIST (ALL MODELS) 3-1

SECTION IV – REPAIR PARTS SETS AND MATERIALS (ALL MODELS) 4-1

SECTION V – NUMERICAL PARTS LIST (ALL MODELS) 5-1

SECTION VI – CUSTOMER SPECIFICATIONS (IO-470)

INTRODUCTION 6-1

IO-470-C 6-2

IO-470-D 6-3

IO-470-E 6-4

IO-470-F 6-5

IO-470-H 6-6

IO-470-J 6-7

IO-470-K 6-8

IO-470-L 6-9

IO-470-M 6-10

IO-470-N 6-11

IO-470-S 6-12

IO-470-U 6-13

IO-470-V 6-14

SECTION VI – CUSTOMER SPECIFICATIONS (O-470)

O-470-B 6-15

O-470-E 6-16

O-470-G 6-17

O-470-J 6-18

O-470-K 6-19

O-470-L 6-20

O-470-M 6-21

O-470-R 6-22

O-470-S 6-23

TABLE 1 6-24

SECTION I

INTRODUCTION

1-1. This parts catalog is presented in looseleaf form so changes can be made to the affected pages only. A registration card is included. Those purchasers who register their catalog will be advised of changes as they occur, at a price to be determined at that time. The registrants will also be advised which pages are affected by the change.

1-2. Page iii of this publication depicts the current status of pages as of the date listed. Each page in the catalog is also dated. To be current, the date on the page should match the date listed for that page on the Status Page. With each change to the catalog issued, a change to the current Status Page will necessarily be issued.

1-3. In this edition, currently available parts are listed for all O-470 and IO-470 engines. If accessories or parts attached to any engine installed in an aircraft manufactured in the United States under a production model number do not appear in this catalog, determine whether they are available from the aircraft manufacturer before placing an order with a Teledyne Continental Authorized Distributor.

1-4. Section II contains 69 figures, in each of which one of the major assemblies or groups of the engine is illustrated in "exploded" form. Each figure has its own set of index numbers to indicate the sub-parts. The list of parts in the assembly or group appears on the same page with the illustration or on an adjacent page. The first column of each assembly group list contains the figure number (not repeated on all lines) and, following a dash, the index numbers of the sub-parts in numerical order. Do not order parts by index number. Use the part number, which appears in the second column. Use the name of the part which appears in the column under the title "DESCRIPTION."

1-5. Do not order any parts listed herein when "NO NUMBER" appears on the same line in the part number column or when "NOT SOLD" herein abbreviated as "NS" appears in the "UNITS PER ASSEM" column, because these parts are not suitable for installation without factory equipment, or they are major parts of assemblies and are more economically supplied in the assembled condition, or they are assemblies which would have to be disassembled for installation. To replace any detail part

"NOT SOLD" order the smallest assembly containing the part (listed above, with name beginning one column to left). To replace any assembly "NOT SOLD," order whatever subassemblies and detail parts (listed below it, with names indented) that are in need of replacement.

1-6. Oversize and undersize parts are listed in Section III. These parts must be ordered by the numbers listed herein, with correct descriptions, to avoid errors. Corresponding standard size part numbers in Section II are preceded by a symbol (+) to indicate the availability of the non-standard size. (Refer to list of abbreviations and symbols.)

1-7. Sets of parts listed in Section IV are usually wanted in such groups for overhaul work and should be ordered by set part numbers.

1-8. Section V contains a list of part numbers arranged in numerical order in the first column. If the number of any desired part is known, the name may be located by referring to the figure and index number in Section II, which is listed opposite the part number in Section V.

1-9. Section VI contains a list of customer specifications of each engine model. The major accessories of each spec is listed, as well as the parts differences between the spec and the basic engine described in Section II. When the customer specification number does not appear on the engine nameplate, refer to the serial number to customer specification cross reference list, Section I.

NOTE . . . The aircraft manufacturer occasionally changes certain accessories per customer request.

LIST OF ABBREVIATIONS AND SYMBOLS

SYMBOL	DEFINITION	SYMBOL	DEFINITION
AR	As Required	RF	Refer to
Dia.	Diameter	NPT	National Pipe Tap (or thread)
ID	Inside Diameter	US	Undersize
In.	Inches	No.	Number
mm	Millimeters	†	Oversize parts available
OD	Outside Diameter	†	Undersize parts available
Opt.	Optional	* * * *	End of group of attaching parts
OS	Oversize	NS	Not Sold
PD	Pitch Diameter (thread)	&	Parts included in a set

ACCESSORY MANUFACTURERS

AC	AC Spark Plug Division General Motors Corporation Flint, Michigan	Harrison	Harrison Radiator Division General Motors Corporation Lockport, New York
Air-Maze	Air-Maze Division Rockwell-Standard Corporation Cleveland, Ohio	Marvel	Marvel-Schebler Products Division Borg-Warner Corporation Decatur, Illinois
Bendix	Bendix Products Division Bendix Corporation South Bend, Indiana	Modine	Modine Manufacturing Company Racine, Wisconsin
Bendix- Scintilla	Bendix Corporation Scintilla Division Sidney, New York	Prestolite	The Prestolite Company Division of Eltra Corporation Toledo, Ohio
Champion	Champion Spark Plug Company Detroit, Michigan	Slick	Slick Electro Incorporated Rockford, Illinois
Delco-Remy	United Motors Service General Motors Building Detroit 2, Michigan		

CUSTOMER SPECIFICATION TO SERIAL NUMBER CROSS REFERENCE

O-470-A

SPEC. 1 40001 thru 40004, 40006, 40009 thru 40026, 40028 thru 40624, 40626 thru 40656, 40658, 40659, 40661 thru 40663, 40665, 40666, 40668 thru 40673, 41001 thru 41043, 41045 thru 41050, 41052 thru 41054, 41056 thru 41062, 41064, 41066 thru 41090, 41093 thru 41136, 41138 thru 41203, 41205 thru 41215, 41217 thru 41221, 41223, 41224, 41226, 41229, 41231 thru 41233, 41235 thru 41259, 41261 thru 41357, 41359 thru 41366, 41368, 41370 thru 41387, 41389 thru 41392, 41394, 41396 thru 41438, 41440 thru 41470, 41472 thru 41483, 41485 thru 41487, 41490 thru 41501, 41503 thru 41508, 41510 thru 41512, 41514 thru 41519, 41521, 41522, 41524, 41527 thru 41534, 41536 thru 41539, 41541 thru 41543, 41545 thru 41547, 41549 thru 41572, 41574 thru 41576, 41578, 41579, 41581 thru 41587, 41589, 41590, 41592 thru 41616, 41618, 41620, 41621, 41624, 41629, 41630, 41632 thru 41640, 41642 thru 41667, 41672 thru 41674

SPEC. 7 41204, 41216, 41222, 41225, 41227, 41228, 41230, 41234, 41260, 41358, 41367, 41369, 41388, 41393, 41395, 41439, 41471, 41484, 41502, 41509, 41513, 41520, 41523, 41525, 41535, 41540, 41544, 41548, 41573, 41577, 41580, 41588, 41591, 41617, 41619, 41622, 41625 thru 41627, 41631, 41641, 41668

O-470-B

SPEC. 6 50001, 50002, 50005 thru 50022, 50025 thru 50031, 50034 thru 50040, 50045, 50046, 50048 thru 50051, 50053 thru 50070, 50073 thru 50091, 50093, 50099 thru 50131, 50139 thru 50178, 50181 thru 50188, 50190 thru 50211, 50216 thru 50231, 50233 thru 50236, 50238 thru 50251, 50253 thru 50256, 50258 thru 50294, 50296 thru 50324, 50336 thru 50343, 50345 thru 50372, 50375, 50381 thru 50399, 50401 thru 50430, 50433 thru 50436, 50438, 50448 thru 50452, 50454 thru 50482, 50489, 50492 thru 50515, 50517 thru 50537, 50542 thru 50592, 50594 thru 50617, 50624 thru 50628, 50643 thru 50652, 50654, 50660 thru 50663, 50668, 50685, 50686, 50691, 50813, 50814, 50817

SPEC. 7 50003, 50004, 50023, 50024, 50041 thru 50044, 50072, 50092, 50094 thru 50098, 50132 thru 50138, 50329 thru 50335, 50376 thru 50380, 50432, 50437, 50439 thru 50447, 50453, 50483 thru 50485, 50629 thru 50638, 50664 thru 50666, 50669, 50671 thru 50677, 50679, 50680, 50682, 50683

SPEC. 17 50189, 50232, 50237, 50252, 50257, 50295, 50344, 50400, 50431, 50516, 50538 thru 50541, 50593, 50619 thru 50623, 50640 thru 50642, 50653, 50655 thru 50659, 50667, 50670, 50678, 50681, 50684, 50687 thru 50690, 50802 thru 50806, 50808 thru 50812

O-470-E

SPEC. 3 60001 thru 60026, 60028 thru 60042, 60045 thru 60074, 60078, 60079, 60081 thru 60087, 60089, 60092, 60093, 60095, 60098, 60099, 60103

O-470-G

SPEC. 1 70001 thru 70067, 70069 thru 70110, 70112 thru 70164, 70166 thru 70492, 70494 thru 70500, 85504, 85505, 85514, 85515, 85524

O-470-J

SPEC. 1 45001 thru 45175, 45177 thru 45239, 45214 thru 45329, 45331 thru 45335, 45337 thru 45353, 45356 thru 45367, 45369 thru 45372, 45374 thru 45377, 45379 thru 45386, 45388 thru 45399, 45401 thru 45423, 45425 thru 45438, 45441 thru 45448, 45450, 45451, 45453 thru 45458, 45460 thru 45481, 45483 thru 45500, 45503 thru 45514, 45516 thru 45520, 45523 thru 45535, 45537 thru 45553, 45555 thru 45557, 45559 thru 45561, 45563 thru 45570, 45576, 45579 thru 45600, 45602 thru 45632, 45634 thru 45656, 45658 thru 45670, 45672 thru 45686, 45688 thru 45704, 45706, 45707, 45726, 45731, 45732, 45734 thru 45752, 45754 thru 45799, 45801 thru 45836, 45838 thru 45841, 45843 thru 45860, 45862, 45863, 45865 thru 45873, 45875 thru 45878, 45880 thru 45892, 45895 thru 45926, 45928 thru 45931, 45933 thru 45941, 45943 thru 45945, 45965 thru 45975, 45977 thru 45981, 46002, 46004, 46007 thru 46009, 46074, 46075, 46163, 46164, 46170 thru 46175, 46186, 46198, 46215, 46221, 46236 thru 46238, 46255, 46271, 46278

SPEC. 3 45176, 45240, 45330, 45336, 45354, 45355, 45368, 45378, 45400, 45424, 45439, 45440, 45482, 45515, 45521, 45522, 45562, 45571, 45572, 45578, 45601, 45657, 45671, 45687, 45708, 45842, 45864, 45879, 45927, 45942, 45946 thru 45949, 45953 thru 45955, 45960, 45962, 45976, 45982 thru 45987, 45989 thru 45991, 45994 thru 45996, 45999 thru 46001, 46003, 46005, 46010, 46018, 46019, 46025 thru 46028, 46030 thru 46034, 46039, 46045, 46049 thru 46052, 46063 thru 46068, 46073, 46077 thru 46079, 46082, 46088 thru 46091, 46104, 46105, 46107, 46116, 46122, 46124, 46127, 46132 thru 46145, 46149 thru 46152, 46154 thru 46158, 46160 thru 46162, 46165, 46166, 46168, 46176 thru 46178, 46192, 46225, 46239

SPEC. 4 45387, 45536, 45554, 45558, 45573 thru 45575, 45577, 45723 thru 45725, 45727 thru 45730, 45733, 45753, 45837, 45874, 45932, 45959, 45993, 45997, 45998, 46006, 46014, 46020 thru 46023, 46035, 46046, 46053, 46059, 46061, 46062, 46081, 46083 thru 46086, 46117 thru 46121, 46123, 46125, 46128 thru 46130, 46146 thru 46148, 46153, 46159, 46169, 46181, 46183 thru 46186, 46188, 46190, 46194, 46195, 46199, 46200, 46203 thru 46205, 46208, 46209, 46211, 46213, 46217 thru 46219, 46222 thru 46224, 46227 thru 46230, 46272, 46276, 46279 thru 46282

SPEC. 6 45459, 45861, 45893, 45894, 45958, 45961, 45963, 45964, 46011, 46024, 46029, 46036 thru 46038, 46041 thru 46044, 46055 thru 46058, 46060, 46069 thru 46072, 46102, 46103

O-470-K

SPEC. 1 47001 thru 47271, 47273 thru 47292, 47294 thru 47323, 47325 thru 47375, 47377 thru 47473, 47475 thru 47487, 47489 thru 47512, 47514, 47515, 47517 thru 47579, 47581 thru 47601, 47604 thru 47608, 47610 thru 47614, 47617, 47619 thru 47623, 47625 thru 47643, 47645 thru 47671, 47674 thru 47740, 47742 thru 47760, 47762 thru 47799, 47801 thru 47808, 47812, 47813, 47815, 47817 thru 47851, 47853 thru 47858, 47861, 47864, 47870 thru 47873, 47900, 47902 thru 47919, 47921, 47922, 47929, 47957 thru 47959, 47961 thru 47986, 48013 thru 48026, 48033 thru 48048, 48050, 48054 thru 48056, 48065 thru 48083, 48088 thru 48091, 48093, 48094, 48096 thru 48098, 48100, 48124, 48154 thru 48157, 48159, 48160, 48162 thru 48198, 48201, 48211, 48219, 48220, 48222, 48228, 48230 thru 48238, 48240 thru 48242, 48244, 48247, 48250, 48320, 48349, 48369 thru 48371, 48396, 48403, 48405, 48407, 48415, 48416, 48418, 48421, 48422, 48437 thru 48440, 48444, 48453, 48454, 48465, 48466, 48499, 48500, 48508, 48530, 48590, 48621, 48643, 48689, 48696, 48701 thru 48750, 48791 thru 48793, 48811, 48823, 48833, 48836, 48837, 48839, 48844, 48847, 48848, 48850, 48859, 48862, 48864, 48866, 48895, 48896, 48927, 48950, 48963, 48967, 48970, 48971, 48973, 48976, 48978, 48980, 48983, 48985, 48991, 48996 thru 48998, 55102, 55103

SPEC. 3 47293, 47474, 47516, 47609, 47615, 47616, 47618, 47624, 47644, 47741, 47761, 47816, 47859, 47860, 47865, 47866, 47874, 47875, 47901, 47950 thru 47955, 48031, 48032, 48049, 48051, 48057, 48058, 48061 thru 48064, 48099, 48153, 48161, 48214, 48216 thru 48218, 48221, 48239, 48282, 48321, 48327, 48348, 48401, 48402, 48417, 48455, 48479, 48483, 48488, 48502, 48503, 48507, 48509, 48539 thru 48541, 48566, 48592, 48613, 48616 thru 48618, 48664, 48666 thru 48668, 48677, 48688, 48690, 48695, 48789, 48840 thru 48842, 48851 thru 48854, 48856 thru 48858, 48860, 48865, 48867, 48875 thru 48877, 48883, 48886, 48887, 48893, 48898, 48899, 48903, 48905, 48908 thru 48910, 48914, 48915, 48919, 48922, 48924 thru 48926, 48928 thru 48930, 48932, 48935, 48936, 48939, 48940, 48943, 48945 thru 48949, 48951, 48953, 48958 thru 48960, 48965, 48974, 48975, 48979, 55111,

SPEC. 5 47488, 47513, 47602, 47603, 47800, 47809 thru 47811, 47814, 47852, 47862, 47863, 47867, 47868, 47876 thru 47878, 47946, 47949, 47956, 47960, 47997, 47998, 48027 thru 48030, 48052, 48053, 48059, 48060, 48084 thru 48086, 48095, 48100, 48101 thru 48106, 48199, 48202 thru 48206, 48223 thru 48225, 48245, 48249, 48276 thru 48281, 48283, 48315 thru 48319, 48330 thru 48333, 48344 thru 48347, 48350 thru 48352, 48372 thru 48381, 48408 thru 48414, 48423 thru 48429, 48458 thru 48461, 48542

SPEC. 9 47880 thru 47899, 47925 thru 47928, 47930 thru 47945, 47987 thru 47996, 47999 thru 48012, 48108 thru 48123, 48125, thru 48152, 48158, 48207 thru 48210, 48212, 48213, 48215, 48248, 48254, 48258, 48285 thru 48295, 48382 thru 48395, 48404, 48556 thru 48565, 48631, 48633 thru 48642, 48644 thru 48663, 48665, 48710, 48712, 48714 thru 48732, 48743 thru 48764, 48768 thru 48770, 48790, 48796 thru 48810, 48814 thru 48816, 48818 thru 48822, 48824 thru 48831, 48834, 48835

SPEC. 14 48226, 48227, 48229, 48243, 48246, 48250, 48251 thru 48253, 48255 thru 48257, 48259 thru 48275, 48430 thru 48436, 48441 thru 48443, 48445 thru 48452, 48456, 48462 thru 48464, 48467 thru 48477, 48480 thru 48482, 48484 thru 48487, 48489 thru 48498, 48504 thru 48506, 48510 thru 48529, 48531 thru 48538, 48543 thru 48555, 48567 thru 48582, 48586, 48593 thru 48595, 48597 thru 48612, 48614, 48615, 48619, 48620, 48622 thru 48630, 48632, 48669 thru 48676, 48678, 48681 thru 48687, 48691 thru 48693, 48699 thru 48709, 48711, 48713, 48734 thru 48741, 48765 thru 48767, 48771 thru 48786, 48788, 48794, 48812, 48813

SPEC. 15 48296 thru 48314, 48322 thru 48326, 48328, 48329, 48334 thru 48343, 48353 thru 48368

O-470-L

SPEC. 1 66001 thru 66520, 66522 thru 66705, 66707 thru 66893, 66899 thru 66937, 66939 thru 67086, 67088 thru 67096, 67098 thru 67220, 67222 thru 67327, 67330 thru 67341 67343 thru 67349, 67356, 67359, 67367, 67368, 67370 thru 67706, 67740, 67741, 67743, 67764, 67766 thru 67779, 67859, 67869, 67871, 67889 thru 67926, 67928 thru 67935, 67937 thru 67952, 67955 thru 68206, 68208 thru 68234, 68236 thru 68252, 68326, 68361 thru 68400, 68438, 68443 thru 68456, 68458 thru 68500, 68502 thru 68628, 68630 thru 68764, 68766 thru 68790, 68810 thru 68829, 68831 thru 69005, 69015, 69038, 69059, 69060, 80001 thru 80023, 80025 thru 80067, 80083 thru 80149, 80171 thru 80178, 80202, 80222, 80224, 80227, 80228, 80231 thru 80259, 80292, 80299, 80305, 80308 thru 80312, 80314, 80316 thru 80342, 80344 thru 80388, 80390 thru 80516, 80650, 80667, 80671, 80682, 80685 thru 80735, 80737, 80771 thru 80780, 80783 thru 80793, 80795, 80796, 80801 thru 80810, 80812 thru 80918, 80920 thru 81049, 81071, 81073 thru 81093, 81095 thru 81097, 81099 thru 81102, 81125, 81132, 81137, 81188, 81190 thru 81195, 81206 thru 81224, 81238, 81383, 81776, 81871, 81933, 81983, 82046, 82083, 82098, 82119, 82124, 82125, 82128, 82132, 82138, 82149, 82151, 82162, 82163, 82165 thru 82167, 82173, 82180, 82182, 82189, 82195, 82197, 82202, 82203, 82207, 82235, 82244, 82266, 82267, 82274

SPEC. 2 66894 thru 66898, 66938, 67087, 67221, 67369, 67875, 67953, 67954, 68207, 68235, 68501, 68629, 80343, 80389, 80781, 80782, 80811, 80919, 81070, 81145, 81147, 81149, 81150, 81198, 81237, 81239, 81340, 81432, 81550, 81719, 81788, 81789, 81872, 81873, 81906, 81932, 81982, 82039, 82042, 82043, 82049, 82065, 82071 thru 82073, 82075 thru 82080, 82085, 82087, 82089 thru 82091, 82093, 82094, 82096, 82101 thru 82106, 82108, 82109, 82114, 82120 thru 82123, 82127, 82133 thru 82137, 82139 thru 82142, 82145, 82146, 82150, 82153, 82154, 82156, 82159 thru 82161, 82170, 82177, 82193, 82199, 82222, 82224, 82230, 22234, 82241, 82242, 82243, 82272

SPEC. 5 67707, 67725, 67729 thru 67739, 67744 thru 67763, 67765, 67780 thru 67807, 68253 thru 68284, 68296, 80542 thru 80600, 81050 thru 81069, 81123, 81124, 81139 thru 81141

SPEC. 6 67708 thru 67724, 67726 thru 67728, 67742, 67808 thru 67858, 67860 thru 67868, 67870, 67872 thru 67874, 67876 thru 67888, 67927, 68285 thru 68295, 68297 thru 68325, 68327 thru 68360, 68401 thru 68437, 68439 thru 68442, 68457, 68765, 68791 thru 68805, 68807 thru 68809, 69006 thru 69014, 69016 thru 69037, 69039 thru 69058, 80024, 80068 thru 80082, 80150 thru 80159, 80161 thru 80169, 80179 thru 80201, 80203 thru 80221, 80223, 80225, 80226, 80229, 80230, 80260 thru 80280, 80282 thru 80291, 80293 thru 80298, 80300 thru 80304, 80306, 80307, 80313, 80315, 80517 thru 80541, 80601 thru 80666, 80668 thru 80670, 80672, 80673, 80675 thru 80681, 80683, 80684, 80736, 80738 thru 80771, 80794, 80797 thru 80800, 81094, 81098, 81103 thru 81122, 81126 thru 81131, 81133 thru 81136, 81138, 81142 thru 81144, 81146, 81148, 81151 thru 81169, 81171 thru 81187, 81189, 81199 thru 81205, 81225 thru 81231, 81236, 81240 thru 81299

SPEC. 10 81072, 81196, 81197, 81232 thru 81235, 81300 thru 81339, 81341 thru 81364, 81394 thru 81399, 81461 thru 81543, 81545, 81547 thru 81549, 81643 thru 81675, 81785 thru 81787, 81791 thru 81793, 81821 thru 81823, 81836, 81842 thru 81849, 81851 thru 81861, 81895 thru 81905, 81907, 81909 thru 81931, 81934 thru 81952, 81958 thru 81981, 81984 thru 81998, 82007 thru 82036, 82041, 82048, 82050 thru 82064, 82066 thru 82070, 82074

SPEC. 12 81747 thru 81775, 81777 thru 81784, 81790, 81794 thru 81817, 81819, 81824, 81827, 81828, 81837 thru 81841, 81862 thru 81870, 81874, 81875, 81877 thru 81895, 81952 thru 81957

SPEC. 13 81365 thru 81382, 81384 thru 81393, 81400 thru 81431, 81433 thru 81460, 81544, 81546, 81551 thru 81615, 81618 thru 81642, 81676 thru 81718, 81720 thru 81746, 81818, 81825, 81826, 81829 thru 81835, 81850

O-470-M

SPEC. 1 51001 thru 51077, 51079 thru 51179, 51181 thru 51204, 51206 thru 51212, 51217 thru 51286, 51289 thru 51354, 51356, 51358 thru 51407, 51410 thru 51471, 51475 thru 51477, 51480, 51481, 51489 thru 51519, 51521, 51523 thru 51607, 51609 thru 51612, 51615, 51617 thru 51633, 51650, 51653, 51656, 51659, 51671, 51674, 51675, 51677, 51685, 51686, 51688, 51690, 51692, 51695 thru 51697, 51700, 51707, 51733, 51737, 51759, 51760, 51762, 51763, 51768, 51773 thru 51779, 51781, 51782, 51790, 51792, 51816, 51832 thru 51851, 51853 thru 51856, 51863, 51871 thru 51873, 51875 thru 51905, 51927 thru 51937, 51939 thru 51958, 51960 thru 51967, 51987 thru 51998, 52000, 52002 thru 52005, 52007 thru 52023, 52027, 52032, 52035 thru 52043, 52048 thru 52102, 52104, 52105, 52108 thru 52128, 52130 thru 52132, 52138 thru 52142, 52144, 52145, 52149, 51151 thru 52157, 52159 thru 52176, 52179, 52181 thru 52214, 52236 thru 52273, 52278 thru 52281, 52298 thru 52312, 52367 thru 52388, 52390, 52391, 52429, 52436 thru 52453, 52456, 52464 thru 52467, 52494, 52496, 52517 thru 52536, 52547, 52548, 52559, 52563, 52567, 52569, 52571, 52580, 52583, 52612 thru 52615, 52617, 52619 thru 52621, 52630, 52643, 52643, 52645 thru 52647, 52650, 52673, 52674, 52695 thru 52699, 52800, 52805, 52808, 52809, 52810, 52811, 52812, 52814, 52815, 52820,, 53700, 53708, 53711, 53721, 53723 thru 53725, 53728 thru 53734, 53744, 53747, 53748, 53753 thru 53755, 53757, 53766, 53767, 53771 thru 53774, 53781, 53782, 53787, 53788, 53791, 53797, 53798

SPEC. 8 51634 thru 51645, 51648, 51651, 51652, 51654, 51655, 51657, 51658, 51660 thru 51668, 51670, 51672, 51673, 51678, 51682, 51684, 51687, 51689, 51693, 51694, 51699, 51702, 51706, 51708 thru 51710, 51712 thru 51732, 51734 thru 51736, 51741 thru 51755, 51772, 51784 thru 51789, 51791, 51793 thru 51811, 51830, 51831, 51852, 51857 thru 51862, 51864 thru 51866, 51868 thru 51871, 51874, 51906 thru 51916, 51919 thru 51926, 51938, 51968 thru 51986, 52024 thru 52026, 52133 thru 52135, 52137, 52143, 52146 thru 52148, 52150, 52274 thru 52277, 52282, 52284, 52285, 52287, 52288, 52290 thru 52293, 52295, 52296, 52317 thru 52346, 52362 thru 52366, 52389, 52392 thru 52403, 52407 thru 52428, 52430 thru 52435, 52454, 52455, 52457 thru 52463, 52468 thru 52482, 52511 thru 52516, 52538 thru 52543, 52545, 52550 thru 52558, 52560 thru 52562, 52566, 52568, 52570, 52573 thru 52579, 52581, 52582, 52584 thru 52601, 52749, 52750, 52765

SPEC. 10 51680, 51681, 51769, 51999, 52001, 52006, 52177, 52495, 52670, 52671, 52801, 52807, 52813, 52816, 52817, 53726, 53727, 53746, 53752, 53757 thru 53760, 53768, 53769, 53777 thru 53780

SPEC. 11 51738, 51739, 51764 thru 51767, 51770, 51771, 51783, 51813 thru 51815, 51817 thru 51825, 51829, 52215 thru 52235, 52313 thru 52316, 52404 thru 52406

SPEC. 12 51669, 51676, 51679, 51683, 51698, 51700, 51701, 51703 thru 51705, 51756 thru 51758, 51827, 51828, 52283, 52286, 52289, 52294, 52297, 52347 thru 52361, 52483 thru 52492, 52497 thru 52510, 52537, 52544, 52546, 52549, 52564, 52565, 52602 thru 52611, 52622 thru 52629, 52631 thru 52642, 52644, 52651 thru 52669, 52672, 52675 thru 52694, 53701 thru 53707, 53709, 53710, 53712 thru 53720, 53722, 53735 thru 53743, 53745

O-470-P

SPEC. 1 75001 thru 75015

O-470-R

SPEC. 1 83001 thru 83004, 83006 thru 83237, 83240 to 83281, 83315, 83316, 83318, 83319, 83322 thru 83355, 83358 thru 83360, 83362 thru 83386, 83391 thru 83600, 83602 thru 83632, 83635, 83637, 83669, 83671 thru 83699, 83715 thru 83837, 83848 thru 83850, 83852 thru 83857, 83859 thru 83862, 84100, 84158, 84161, 84162, 84164, 84408, 84671, 84673, 84964, 130164, 130354 thru 130356, 130406, 130577, 131187

SPEC. 2 83238, 83239, 83282 thru 83314, 83317, 83320, 83321, 83356, 83357, 83361, 83387 thru 83390, 83633, 83634, 83636, 83638 thru 83668, 83670, 83700 thru 83714, 83838 thru 83847, 83851, 83858, 83863 thru 83894, 83896 thru 83914, 83930 thru 83936, 83938, 83942 thru 83946, 83948, 83950 thru 83964, 83990, 84086, 130052

SPEC. 3 83895, 83915 thru 83925, 83937, 83939 thru 83941, 83947, 83949, 83965 thru 83989, 83991 thru 84085, 84087 thru 84099, 84101 thru 84113, 84144 thru 84153, 84155 thru 84157, 84159, 84160, 84163, 84165 thru 84179, 84181 thru 84253, 84255 thru 84288, 84311 thru 84407, 84409 thru 84478, 84480 thru 84633, 84635 thru 84658, 84660 thru 84670, 84672, 84675 thru 84746, 84748 thru 84760, 84762 thru 84765, 84767 thru 84813, 84815, 84826, 84827, 84838 thru 84840, 84842, 84866, 84915 thru 84945, 84950 thru 84963, 84965 thru 84967, 84969 thru 84990, 84992 thru 84999, 130000, 130001, 130008 thru 130036, 130038 thru 130042, 130044 thru 130049, 130051, 130053, 130094, 130095, 130106, 130109 thru 130136, 130138 thru 130161, 130163, 130165 thru 130172, 130174 thru 130190, 130192, 130195, 130208, 130210, 130212, 130214, 130216 thru 130221, 130223, 130225, 130227, 130229, 130231, 130233 thru 130235, 130237, 130239, 130243 thru 130257, 130259 thru 130269, 130271 thru 130277, 130279 thru 130331, 130334 thru 130353, 130357 thru 130359, 130361 thru 130368, 130370 thru 130402, 130404, 130407 thru 130428, 130448, 130449, 130451 thru 130455, 130458, 130480, 130486 thru 130488, 130515, 130519, 130520, 130523 thru 130529, 130531 thru 130543, 130545 thru 130557, 130561, 130567, 130573, 130575, 130576, 130579, 130580, 130583, 130585, 130586, 130589, 130591, 130593 thru 130595, 130597 thru 130605, 130607 thru 130609, 130611 thru 130613, 130615 thru 130624, 130627 thru 130632, 130634 thru 130639, 130646, 130648, 130650, 130652 thru 130654, 130656, 130657, 130659, 130661 thru 130677, 130680, 130684, 130698, 130783, 130786, 130807, 130839, 130858, 130881, 130884, 131207, 131213, 131241, 131372, 131430, 131501, 131502, 131633, 131852, 131853, 131930, 132355, 132359, 132360, 132498, 132765, 133096 thru 133098, 133459 thru 133461, 133559, 133590, 133591, 133750, 133751, 133762, 133912, 133914, 133947, 133948, 191047, 191049, 191125, 191126, 191130, 191131, 191236, 191343, 191577, 191578

SPEC. 4 84114 thru 84143, 84289 thru 84309, 84814, 84841, 84848 thru 84858, 84860 thru 84865, 84867 thru 84873, 84875 thru 84878, 84880 thru 84914, 84947 thru 84949, 130096, 130191, 130193, 130194, 130196 thru 130207, 130209, 130211, 130213, 130215, 130222, 130224, 130226, 130228, 130230, 130232, 130236, 130238, 130240 thru 130242, 130403, 130429 thru 130436, 130440 thru 130443, 130445, 130446, 130456, 130460 thru 130463, 130465, 130467, 130469, 130471, 130473, 130475, 130477, 130479, 130481, 130483, 130501, 130503, 130513, 130687 thru 130697, 130699 thru 130707, 130709 thru 130727, 130747, 133104

SPEC. 9 84816 thru 84825, 84828 thru 84837, 84843 thru 84847, 84991, 130007, 130037, 130043, 130050, 130054 thru 130081, 130083 thru 130093, 130099 thru 130105, 130107, 130108, 130437 thru 130439, 130444, 130447, 130457, 130459, 130464, 130466, 130468, 130470, 130472, 130474, 130476, 130478, 130482, 130484, 130485, 130489 thru 130492, 130494 thru 130500, 130502, 130504 thru 130512, 130514, 130516 thru 130518, 130521, 130522, 130558 thru 130560, 130562 thru 130566, 130568 thru 130572, 130574, 130581, 130582, 130584, 130587, 130588, 130590, 130596, 130606

SPEC. 11 130082, 130098, 130258, 130332, 130333, 130405, 130450, 130493, 130544, 130644, 130708, 130811, 130879, 130883, 130327, 130328, 131438, 133731, 191051, 200023, 200034 thru 200036

SPEC. 15 130530, 130610, 130614, 130625, 130626, 130633, 130640 thru 130643, 130645, 130647, 130649, 130651, 130655, 130658, 130660, 130678, 130679, 130681 thru 130683, 130685, 130686, 130729 thru 130746, 130748, 130749, 130751 thru 130782, 130784, 130785, 130787 thru 130806, 130808 thru 130810, 130812 thru 130838, 130840 thru 130857, 130859, 130861 thru 130878, 130885 thru 130892, 130894 thru 130966, 130971 thru 131135, 131137 thru 131186, 131188 thru 131206, 131209 thru 131212, 131214 thru 131240, 131242 thru 131319, 131321 thru 131326, 131329 thru 131356, 131358 thru 131371, 131373 thru 131407, 131409 thru 131429, 131431 thru 131437, 131439 thru 131471, 131473 thru 131500, 131503 thru 131600, 131613 thru 131623, 131626 thru 131632, 131634 thru 131762, 131764 thru 131851, 131855 thru 131909, 131916 thru 131929, 131931 thru 132312, 132314, 132319, 132639 thru 132641, 133117, 133118, 133250, 133462, 133463, 133735, 133949, 191053, 191176, 191426, 191782

SPEC. 20 132313, 132315 thru 132318, 132320 thru 132354, 132361 thru 132447, 132449 thru 132530, 132532, 132534 thru 132554, 132556 thru 132615, 132618 thru 132634, 132636, 132637, 132645 thru 132764, 132772 thru 132927, 132929 thru 132931, 132933 thru 133066, 133068, 133069, 133071 thru 133093, 133104 thru 133116, 133119 thru 133127, 133129 thru 133136, 133138, 133140, 133141, 133144, 133145, 133147, 133149 thru 133151, 133153, 133155 thru 133249, 133251 thru 133294, 133314, 133315, 133321 thru 133339, 133341 thru 133348, 133350 thru 133372, 133398 thru 133457, 133476, 133479, 133484, 133485, 133497, 133498, 133500, 133505, 133508, 133510 thru 133558, 133560 thru 133589, 133592 thru 133730, 133732 thru 133734, 133738 thru 133740, 133752 thru 133758, 133761, 133763, 133766 thru 133876, 133883 thru 133911, 133913, 133919 thru 133946, 133951 thru 133999, 191001 thru 191009, 191011 thru 191046, 191048, 191054 thru 191124, 191127 thru 191129, 191132 thru 191174, 191177 thru 191234, 191237 thru 191342, 191352 thru 191356, 131371 thru 191388, 191390 thru 191394, 191397 thru 191422, 191432 thru 191480, 191485, 191489 thru 191494, 191496 thru 191503, 191505 thru 191507, 191509, 191510, 191514 thru 191519, 191521 thru 191526, 191528 thru 191560, 191585, 191587 thru 191781, 191783 thru 191851, 191856 thru 191912, 191914 thru 191957, 191963 thru 191999, 194551 thru 194580, 194587 thru 194613, 194619 thru 194659, 194662 thru 194709, 194711 thru 194720, 194726, 194729, 194732, 194735 thru 194737, 194739, 202619

SPEC. 23 132531, 132533, 132555, 132616, 132617, 132635, 132638, 132642 thru 132644, 132766 thru 132771, 132928, 132932, 133067, 133070, 133128, 133137, 133139, 133142, 133143, 133146, 133148, 133152, 133154, 133295 thru 133298, 133300 thru 133313, 133316 thru 133320, 133373 thru 133397, 133464 thru 133475, 133477, 133478, 133480 thru 133483, 133486 thru 133496, 133498, 133501 thru 133504, 133506, 133507, 133509, 133744 thru 133749, 133877 thru 133882, 191175, 191179, 191344 thru 191351, 191357 thru 191370, 191389, 191481 thru 191484, 191486 thru 191488, 191495, 191504, 191508, 191511 thru 191513, 191520, 191527, 191561 thru 191576, 191579 thru 191581, 191583, 191852 thru 191855, 194618, 202970, 203098, 222419, 222636, 222637, 222638

SPEC. 25 194742, 194750 thru 194758, 194760 thru 194919, 194921 thru 194924, 194926 thru 195000, 200000 thru 200019, 200030, 200038 thru 200134, 200136 thru 200138, 200140 thru 200199, 202501 thru 202555, 202557, 202558, 202560 thru 202565, 202568 thru 202618, 202620 thru 202790, 202793 thru 202812, 202814 thru 202888, 202892 thru 202931, 202933, 202938, 202941 thru 202947, 202950, 202952, 202962 thru 202969, 202971 thru 203067, 203069 thru 203096, 203099, 203100, 203102 thru 203170, 203172 thru 203178, 203181 thru 203200, 203202 thru 203296, 203299 thru 203329, 203331, 203332, 203333, 203335 thru 203342, 203344 thru 203355, 203357 thru 203374, 203388 thru 203391, 203395 thru 203440, 203442 thru 203500, 211000 thru 211029, 211031 thru 211111, 211113 thru 211120, 211124 thru 211145, 211147, 211150, 211151, 211152, 211154, 211156, 211158, 211159, 211160, 211168, 211171 thru 211189, 211191 thru 211198, 211200 thru 211232, 211234 thru 211245, 211247 thru 211262, 211266 thru 211301, 211306, 211309, 211310, 211314, 211316 thru 211369, 211371 thru 211384, 211386 thru 211407, 211410 thru 211418, 211420 thru 211424, 211426, 211428, 211430 thru 211467, 211469 thru 211474, 211476 thru 211480, 211483, 211484, 211485, 211487 thru 211495, 211497, 211498, 211500 thru 211510, 211512, 211513, 211516 thru 211535, 211539 thru 211547, 211550 thru 211554, 211556 thru 211564, 211567, 211568, 211574 thru 211583, 211585, 211588 thru 211593, 211596 thru 211606, 211609 thru 211613, 211618 thru 211623, 211625 thru 211635, 211638, 211639, 211640, 211642, 211643, 211644, 211646, 211647, 211654 thru 211664, 211669 thru 211676, 211678 thru 211687, 211689, 211691 thru 211697, 211699 thru 211704, 211707, 211714 thru 211730, 211732, 211734 thru 211747, 211754, 211755, 211757 thru 211763, 211765 thru 211771, 211777, 211778, 211779, 211784 thru 211793, 211798, 211800, 211801, 211802 thru 211809, 211811 thru 211821, 211823, 211826, 211828, 211830, 211832, 211834, 211836, 211837, 211839, 211841, 211843, 211848 thru 211864, 211866 thru 211879, 211881, 211883 thru 211890, 211892 thru 211908, 211910, 211912 thru 211919, 211921, 211923 thru 211927, 211929 thru 211935, 211939 thru 211944, 211946, 211947, 211948, 211952 thru 211962, 211964, 211966 thru 211983, 211986 thru 211200, 222401 thru 222404, 222406, 222410, 222412 thru 222415, 222420 thru 222429, 222432 thru 222440, 222443 thru 222458, 222462 thru 222478, 222480, 222482, 222484 thru 222489, 222492 thru 222499, 222501 thru 222503, 222505 thru 222545, 222547 thru 222556, 222559, 222568 thru 222570, 222572 thru 222575, 222578 thru 222589, 222591 thru 222600, 222642 thru 222667, 222670 thru 222691, 222693, 222695 thru 222712, 222714 thru 222716, 222720 thru 222737, 222739, 222741 thru 222744, 222747 thru 222797, 222800 thru 222816, 222819 thru 222829, 222831 thru 222834, 222836 thru 222840, 222842 thru 222849, 222851 thru 222859, 222871, 222873 thru 222898, 222900 thru 222902, 222904, 222907, 222909, 222911, 222912, 222927 thru 222949, 222951, 222953 thru 222954, 222957, 222959 thru 222966, 222968 thru 223000, 223500 thru 223521, 223524 thru 223528, 223534 thru 223552, 223554 thru 223556, 223560 thru 223595, 223599 thru 223618

SPEC. 35 211408, 211409, 211419, 211468, 211475, 211481, 211482, 211486, 211496, 211499, 211511, 211514, 211515, 211536, 211537, 211538, 211548, 211549, 211555, 211566, 211570 thru 211573, 211584, 211586, 211587, 211594, 211595, 211607, 211608, 211645, 211648, 211649, 211651, 211652, 211653, 211665 thru 211668, 211690 211698, 211701 thru 211705, 211708 thru 211713, 211733, 211748 thru 211751, 211753, 211756, 211764, 211772 thru 211776, 211780 thru 211783, 211794, 211795, 211799, 211801, 211810, 211822, 211824, 211825, 211827, 211829, 211831, 211833, 211835, 211838, 211840, 211842, 211844, 211845, 211846, 211865, 211880, 211882, 211891, 211905, 211909, 211911, 211920, 211922, 211928, 211936, 211937, 211938, 211945, 222984, 222985, 222405, 222407 thru 222409, 222411, 222430, 222431, 222441, 222442, 222459 thru 222461, 222483, 222490, 222491, 222500, 222546, 222560 thru 222562, 222571, 222576, 222577, 222590, 222601 thru 222635, 222638, 222639, 222669, 222692, 222694, 222713, 222717 thru 222719, 222738, 222740, 222745, 222746, 222798, 222799, 222817, 222835, 222868 thru 222870, 222872, 222899, 222908, 222910, 222913 thru 222926, 222950, 222952, 222955, 222956, 222958, 222967, 223522, 223529 thru 223533, 223553, 223557 thru 223559, 223596 thru 223598

IO-470-C

SPEC. 1 71005 thru 71020, 71022 thru 71117, 71119 thru 71121, 71123 thru 71159, 71161 thru 71315, 71317 thru 71385, 71387 thru 71496, 71498 thru 71678, 71681 thru 71749, 71751 thru 71801, 71803 thru 71807, 71809 thru 71870, 71872 thru 71911, 71913 thru 71946, 71948 thru 72033, 72036 thru 72257, 72259 thru 72299, 72301, 72302, 72303, 72306 thru 72314, 72317 thru 72333, 72335 thru 72342, 72345 thru 72349, 72351 thru 72364.

IO-470-D

SPEC. 1 75001 thru 75011, 75013 thru 75077, 75079 thru 75081, 75084 thru 75118, 75120 thru 75129, 75131 thru 75135, 75142, 75160 thru 75184, 75186 thru 75235, 75238, 75241 thru 75264, 75266 thru 75339, 75341 thru 75344, 75346 thru 75355, 75357, 75367, 75370, 75453 thru 75460, 75464 thru 75471, 75473 thru 75476, 75478, 75481, 75492, 75493, 75495 thru 75502, 75506 thru 75510, 75512 thru 75518, 75520 thru 75524, 75526, 75527, 75529 thru 75532, 75535 thru 75549, 75551 thru 75553, 75555, 75557 thru 75563, 75566 thru 75568, 75570, 75575 thru 75578, 75664 thru 75669, 75722, 75741, 75743 thru 75749, 75772, 75954, 75955, 75964, 75965, 79011, 79040, 79043, 79050, 79055, 79134, 79145, 79158, 79159, 79191, 79275, 79391, 79476, 79616, 79618, 79622, 79626, 79644, 79645, 79683, 79687, 104047, 104136, 104137, 104180, 104181

SPEC. 4 75130, 75136 thru 75141, 75143 thru 75159, 75340, 75345, 75356, 75358 thru 75366, 75368, 75369, 75371 thru 75377, 75380 thru 75392, 75394 thru 75417, 75419, 75420, 75422 thru 75425, 75427, 75428, 75461 thru 75463, 79112, 79114, 104362, 104363

SPEC. 5 75236, 75237, 75239, 75240, 75443, 75451, 75482, 75483, 75511, 75519, 75528, 75550, 75600, 75601, 79205, 79209, 79236, 79237, 79338, 79625, 79627

SPEC. 7 75421, 75426, 75429 thru 75442, 75444 thru 75450, 75452, 75472, 75477, 75479, 75480, 75484 thru 75488, 75490, 75494, 75503 thru 75505

SPEC. 9 75525, 75533, 75534, 75554, 75556, 75564, 75565, 75571 thru 75574, 75579 thru 75599, 75602 thru 75612, 75620 thru 75637, 75642, 75651, 75717 thru 75721, 75723 thru 75740, 75742, 75750 thru 75770, 75773, 75774, 75776 thru 75859, 75861 thru 75874, 75876 thru 75953, 75956 thru 75963, 75966 thru 75991, 79001, 79016 thru 79039, 79041, 79042, 79044 thru 79049, 79051 thru 79054, 79056 thru 79064, 79072 thru 79083, 79102 thru 79111, 79174, 79176 thru 79178, 79195, 79198, 79272, 79273, 79381, 79382, 79438, 79491, 79521, 79562, 79578, 79601, 79614, 79659 thru 79662, 79684, 79711 thru 79713, 79785, 79830, 104021, 104022, 104036, 104038, 104048, 104100, 104108, 104145, 104358, 104371

- SPEC. 12** 75613 thru 75617, 75638 thru 75641, 75643 thru 75648, 75650, 75653 thru 75655, 75657 thru 75663, 75670 thru 75690, 75692 thru 75716, 75992 thru 75999, 79002 thru 79010, 79013 thru 79015, 79084 thru 79100, 79113, 79115 thru 79126, 79128 thru 79133, 79135 thru 79144, 79146 thru 79157, 79160, 79161, 79166, 79170 thru 79173, 79175, 79179 thru 79190, 79192 thru 79194, 79196, 79197, 79200, 79202 thru 79204, 79206, 79208, 79229, 79628, 79641, 79658, 79685, 79686, 79710, 79932, 79933, 104020, 104060, 104086, 104187, 104188, 104288 thru 104291, 104317, 104318, 104407, 104412, 104413, 104432, 104447, 104450, 104451, 104453, 104605, 104637, 104638
- SPEC. 15** 79162 thru 79165, 79168, 79169, 79199, 79201, 79207, 79210 thru 79227, 79238 thru 79242, 79244 thru 79271, 79274, 79276 thru 79278, 79285 thru 79337, 79339 thru 79343, 79345 thru 79365, 79368, 79369, 79383 thru 79390, 79392 thru 79413, 79415, 79419 thru 79421, 79426, 79427, 79429 thru 79437, 79439 thru 79475, 79477 thru 79489, 79492, 79493, 79495 thru 79520, 79522 thru 79526, 79528 thru 79538, 79540 thru 79542, 79544, 79546 thru 79551, 79553, 79556 thru 79558, 79560, 79564, 79566 thru 79577, 79579, 79581 thru 79600, 79603 thru 79609, 79613, 79615, 79617, 79619, 79808, 79809, 79811, 79831, 79850, 79851, 79854, 79855, 79857, 79879, 79880, 104465, 104494, 104514, 104539, 104540
- SPEC. 19** 79629 thru 79640, 79642, 79646, 79649 thru 79654, 79663 thru 79682, 79688 thru 79694, 79697, 79700 thru 79709, 79714 thru 79743, 79747 thru 79750, 79752 thru 79757, 79760, 79761, 79763 thru 79765, 79767 thru 79784, 79786 thru 79807, 79810, 79812 thru 79817, 79819 thru 79823, 79825 thru 79828, 79832 thru 79846, 79852, 79853, 79856, 79858 thru 79878, 79881 thru 79901, 79904 thru 79906, 79908 thru 79925, 79934 thru 79965, 79967, 79968, 79971, 79973 thru 79999, 104000 thru 104008, 104010 thru 104017, 104023 thru 104029, 104033, 104037, 104039 thru 104044, 104046, 104049 thru 104052, 104056, 104058, 104063 thru 104065, 104068, 104448, 104486, 104487, 104527, 104528, 104536 thru 104538, 104556 thru 104559, 104569, 104570, 104587, 104588, 104610, 104611, 104628, 104629, 104634, 104642, 104657 thru 104660, 104683, 104686
- SPEC. 25** 79766, 79818, 104009, 104218, 104244, 104245, 104294, 104295, 104380, 104405, 104436, 104437, 104442, 104466 thru 104468, 104492, 104495 thru 104497, 104501 thru 104508
- SPEC. 27** 104053 thru 104055, 104057, 104059, 104061, 104062, 104069 thru 104082, 104084, 104087 thru 104093, 104095, 104097 thru 104099, 104101 thru 104107, 104109 thru 104115, 104117, 104119 thru 104135, 104138 thru 104144, 104146 thru 104152, 104158 thru 104168, 104171 thru 104179, 104182 thru 104186, 104190 thru 104207, 104209 thru 104214, 104216, 104217, 104219, 104220, 104223, 104226, 104228 thru 104243, 104246 thru 104267, 104269 thru 104284, 104287, 104292, 104293, 104299 thru 104309, 104311 thru 104316, 104319 thru 104341, 104343 thru 104352, 104354 thru 104357, 104364 thru 104369, 104372 thru 104379, 104381, 104382, 104384 thru 104387, 104389 thru 104399, 104402 thru 104404, 104418 thru 104421, 104423 thru 104430, 104457, 104488, 104489, 104526, 104560 thru 104562, 104572, 104573, 104575, 104576, 104591, 104592, 104598, 104601, 104609, 104613 thru 104617, 104630, 104632, 104645 thru 104650, 104665, 104666, 104684, 104685
- SPEC. 30** 79966, 79972, 104034, 104035, 104094, 104096, 104154, 104221, 104222, 104310, 104401, 104414, 104440, 104460, 104461, 104462, 104469, 104474, 104481, 104483, 104490, 104491, 104512, 104513, 104520, 104532, 104533, 104567, 104568, 104571, 104574, 104581, 104582, 104585, 104586, 104594, 104602, 104607, 104619, 104620, 104621, 104631, 104633, 104636, 104639, 104640, 104641, 104643, 104644, 104653, 104654, 104663, 104664
- SPEC. 42** 104477, 104478, 104510, 104511, 104550, 104551, 104564, 104565, 104577 thru 104580, 104593, 104595 thru 104597, 104599, 104600, 104608, 104612, 104622 thru 104627, 104655, 104656, 104667, 104668, 104671 thru 104682, 104687 thru 104702
- SPEC. 50** 104635, 104651, 104652

IO-470-E

- SPEC. 1** 77001, 77006 thru 77325, 77346, 77387 thru 77389, 77393 thru 77526, 77573 thru 77580, 77582, 77585 thru 77587, 77591, 77592, 77610, 77621, 77639, 77643, 77772, 77866, 77898, 77907, 77911, 77922, 77929
- SPEC. 5** 77347 thru 77386, 77390 thru 77392, 77532 thru 77560, 77562 thru 77572, 77622, 77623
- SPEC. 6** 77581, 77583, 77584, 77589, 77590, 77595 thru 77609, 77611 thru 77620, 77624 thru 77638, 77640 thru 77642, 77645 thru 77706, 77708 thru 77747, 77749 thru 77771, 77773 thru 77784, 77786, 77789, 77835 thru 77851, 77862 thru 77865, 77867 thru 77877, 77879, 77883, 77885, 77895, 77897, 77899, 77900, 77903, 77905, 77906, 77910
- SPEC. 7** 77785, 77787, 77788, 77790 thru 77816, 77818 thru 77829

IO-470-F

- SPEC. 1** 76001 thru 76088, 76090 thru 76124, 76126, 76128 thru 76135, 76938, 135103, 135125, 135126, 135140, 135155, 135162, 135165, 135187, 135203, 135204, 135218, 135219, 135277, 135281 thru 135284, 135287, 135299, 135303, 135305 thru 135309, 135311, 135318, 135319, 135324, 135326, 135345, 135368 thru 135370, 135372, 135389 thru 135401, 135421 thru 135425, 135448, 135450, 135451, 135453, 135459 thru 135461, 135463 thru 135467, 135472 thru 135481, 135496 thru 135501, 135508, 135533 thru 135535, 135545 thru 135549, 135555, 135556, 135560, 135562, 135564, 135567, 135578, 135588 thru 135590, 135592 thru 135599, 135616, 135618, 135619, 135644, 135646, 135647, 135662, 135668, 135672, 135710, 135711, 135717, 135732, 135733, 135750, 135752
- SPEC. 3** 76125, 76127, 76136 thru 76385, 76387 thru 76436, 76438 thru 76450, 76452 thru 76570, 76577 thru 76606, 76612 thru 76661, 76663, 76664, 76668, 76673 thru 76677, 76679 thru 76684, 76728, 76730, 76736, 76737, 76741, 76756, 76790, 76802, 76804, 76807, 76824, 76835, 76857, 76862, 76863, 76907, 76913, 76917, 76966, 135021, 135041, 135045, 135061, 135065, 135067, 135096, 135099, 135113, 135133, 135139, 135145, 135160, 135213 thru 135215, 135260, 135261, 135294, 135310, 135371, 135377, 135384 thru 135386, 135426, 135452, 135470, 135471, 135484 thru 135488, 135505, 135506, 135520, 135538 thru 135540, 135563, 135569, 135570, 135577, 135579 thru 135586, 135611, 135612, 135622, 135623, 135649, 135657, 135658, 135663, 135674, 135675, 135677, 135702, 135709, 135712, 135713, 135715, 135716
- SPEC. 5** 76437, 76751 thru 76576, 76607 thru 76609, 76611, 76662, 76665 thru 76667, 76669, 76671, 76678, 76696, 76697, 76703, 76707, 76713, 76720, 76727, 76729, 76738, 76744, 76749, 76757, 76758, 76765, 76769, 76789, 76801, 76803, 76806, 76808, 76810, 76815, 76827, 76861, 76871, 76878, 76906, 76908, 76911, 76914 thru 76916, 76929, 76941, 76945, 76946, 76983, 76984, 135022, 135038 thru 135040, 135057, 135063, 135064, 135066, 135068 thru 135071, 135074, 135101, 135102, 135109 thru 135112, 135127 thru 135130, 135137, 135138, 135142, 135158, 135161, 135179, 135211, 135212, 135246, 135293, 135374, 135402, 135405 thru 135412, 135483, 135521, 135757, 135762, 135782, 135797
- SPEC. 7** 76670, 76672, 76685 thru 76695, 76698 thru 76702, 76704 thru 76706, 76722 thru 76724, 76731 thru 76735, 76751 thru 76755, 76759 thru 76764, 76766 thru 76768, 76770 thru 76778, 76780 thru 76788, 76791 thru 76800, 76809, 76811 thru 76814, 76816 thru 76821, 76829, 76836 thru 76839, 76848 thru 76856, 76901 thru 76905, 76912, 76918 thru 76928, 76930 thru 76936, 76939, 76940, 76942 thru 76944, 76947 thru 76964, 76968 thru 76970, 76974, 76977, 76981, 76982, 76985 thru 76993, 135012 thru 135020, 135023 thru 135026, 135028 thru 135037, 135042 thru 135044, 135051 thru 135056, 135058, 135059, 135107, 135108, 135132, 135494, 135495, 135518, 135519, 135613, 135634, 135653 thru 135656, 135660, 135673, 135745, 135761, 135763 thru 135770, 135774, 135776, 135799, 135801
- SPEC. 8** 76708 thru 76712, 76739, 76740, 76742, 76743, 76745 thru 76748, 76750, 135542

SPEC. 9 76714 thru 76719, 76779 thru 76785, 76965, 76967, 76972, 76973, 76975, 76976, 76978 thru 76980, 76995 thru 76999, 135004 thru 135011, 135046 thru 135050, 135131, 135134 thru 135136, 135457

SPEC. 11 76822, 76823, 76826, 76828, 76830 thru 76834, 76840 thru 76847, 76859, 76860, 76864, 76870, 76886 thru 76900, 76910, 76994, 135072, 135073, 135141, 135143, 135144, 135146 thru 135154, 135163, 135164, 135168, 135169, 135171 thru 135176, 135180, 135186, 135189, 135192, 135194, 135195, 135201, 135205

SPEC. 17 135060, 135062, 135075 thru 135095, 135097, 135098, 135100, 135104 thru 135106, 135114 thru 135124, 135157, 135159, 135166, 135167, 135170, 135177, 135178, 135181 thru 135184, 135206 thru 135210, 135232, 135237, 135238, 135241, 135242, 135244, 135248, 135249, 135251, 135256 thru 135258, 135262, 135264, 135266, 135268, 135270 thru 135276, 135278 thru 135280, 135285, 135286, 135288, 135290, 135291, 135297, 135300 thru 135302, 135304, 135312 thru 135317, 135327, 135332 thru 135339, 135351 thru 135367, 135373, 135375, 135376, 135378 thru 135383, 135388, 135456, 135708, 135718 thru 135721

SPEC. 18 135216, 135217, 135220 thru 135227, 135229 thru 135231, 135233, 135239, 135240, 135243, 135245, 135247, 135250, 135252, 135253, 135259, 135263, 135265, 135267, 135269, 135289, 135292, 135295, 135296, 135298, 135328 thru 135331, 135341 thru 135344, 135348 thru 135351, 135403, 135404, 135414, 135416 thru 135420, 135428, 135430 thru 135443, 135446, 135449, 135454, 135455, 135458, 135462, 135482, 135502, 135503, 135507, 135512 thru 135517, 135522, 135524 thru 135532, 135536, 135541, 135543, 135544, 135550 thru 135554, 135557 thru 135559, 135561, 135565, 135566, 135568, 135571 thru 135576, 135600 thru 135606, 135608, 135609, 135610, 135615, 135620, 135621, 135624 thru 135633, 135635, 135636, 135638, 135640, 135641, 135643, 135652, 135669, 135722, 135753, 135754, 135759, 135760, 135779, 135780, 135781, 135785, 135786, 135796, 135798

IO-470-H

SPEC. 1 87002 thru 87009, 87011 thru 87099, 87100 thru 87169

IO-470-J

SPEC. 1 85101 thru 85270, 85272 thru 85399, 85400 thru 85416, 85420, 85421, 85424, 85426, 85427, 85432, 85433, 85434

IO-470-K

SPEC. 3 86001 thru 86258, 86260 thru 86310, 86313 thru 86532, 86534 thru 86583, 86585 thru 86611, 86613 thru 86716, 86718 thru 86741, 86744 thru 86798, 86800 thru 86805, 86809 thru 86851, 86854, 86856 thru 86946, 86949 thru 86969, 86971, 86972, 86974, 86975, 86977 thru 86980, 86984, 86985, 86986, 86989

SPEC. 11 86981, 86982, 86996 thru 87000, 203501 thru 203505, 203508 thru 203511, 203518 thru 203536

IO-470-L

SPEC. 1 90001 thru 90060, 90063 thru 90252, 91236, 91237, 91242, 91674, 91675, 155268

SPEC. 3 90253 thru 90422, 90424 thru 90458, 90460 thru 90522, 90524 thru 90551, 90553 thru 90559, 90564, 90722, 90918, 91673, 91768, 91954, 91955, 155056, 155528, 155529, 155547, 155894, 155895

- SPEC. 5** 90552, 90560 thru 90563, 90565 thru 90596, 90598 thru 90606, 90609 thru 90645, 90647 thru 90668, 90670 thru 90713, 90715, 90718 thru 90721, 90723 thru 90740, 90742 thru 90763, 90766 thru 90833, 90835 thru 90912, 90914, 90916, 90917, 90919 thru 90942, 90944 thru 91043, 91045 thru 91071, 91073 thru 91098, 91100 thru 91153, 91155 thru 91235, 91238 thru 91241, 91243 thru 91260, 91262 thru 91265, 91267, 91268, 91270 thru 91304, 91306 thru 91320, 91322 thru 91355, 91357 thru 91457, 91459 thru 91515, 91518 thru 91564, 91566 thru 91672, 91676 thru 91702, 91704 thru 91716, 91746, 91747, 91790, 91836, 91854 thru 91857, 91872, 91886, 91926, 91930, 91931, 91934, 91939, 91940, 91956, 155011, 155017, 155019, 155020, 155093, 155106, 155108, 155120, 155233, 155236 thru 155238, 155267, 155285, 155530, 155557, 155877
- SPEC. 8** 91703, 91718 thru 91745, 91748 thru 91767, 91769 thru 91789, 91791 thru 91795, 91798, 91800 thru 91810, 91812 thru 91835, 91837 thru 91853, 91858 thru 91871, 91873 thru 91885, 91887 thru 91925, 91932, 91933, 91935, 91937, 91938, 91941 thru 91953, 91957 thru 91984, 91986 thru 91999, 155001 thru 155010, 155012 thru 155016, 155018, 155021 thru 155045, 155048 thru 155055, 155057 thru 155087, 155089 thru 155092, 155094 thru 155105, 155109 thru 155112, 155192, 155195, 155230, 155231, 155263 thru 155265, 155293, 155295, 155300, 155373 thru 155378, 155415, 155418, 155421, 155438 thru 155440, 155471, 155473, 155477 thru 155481, 155485, 155537, 155539, 155541, 155542, 155582, 155586, 155587, 155596, 155597, 155684 thru 155687, 155975, 155976, 201076, 201155
- SPEC. 9** 155118, 155121 thru 155156, 155159, 155162 thru 155170, 155176 thru 155191, 155193, 155194, 155196 thru 155199, 155202 thru 155229, 155232, 155234, 155235, 155239 thru 155262, 155269 thru 155284, 155286 thru 155292, 155294, 155296 thru 155333, 155336, 155338 thru 155349, 155352, 155353, 155355 thru 155372, 155386, 155388 thru 155414, 155416, 155417, 155419, 155420, 155423 thru 155437, 155441 thru 155449, 155452, 155453, 155472, 155482, 155486, 155488, 155491 thru 155493, 155495, 155497 thru 155501, 155509, 155511, 155512, 155514 thru 155516, 155519, 155525, 155534 thru 155536, 155538, 155540, 155543 thru 155546, 155573 thru 155580, 155590 thru 155595, 155598 thru 155603, 155606 thru 155617, 155620 thru 155630, 155635 thru 155677, 155688 thru 155762, 155764 thru 155767, 155769 thru 155782, 155784 thru 155789, 155792 thru 155876, 155879 thru 155883, 155885 thru 155888
- SPEC. 13** 155379 thru 155384, 155387, 155422, 155454 thru 155468, 155483, 155484, 155502 thru 155508, 155510, 155517, 155518, 155526, 155527, 155531 thru 155533, 155548 thru 155554, 155558 thru 155572, 155583, 155588, 155589, 155604, 155605, 155618, 155619, 155631 thru 155634, 155783
- SPEC. 15** 155878, 155884, 155889 thru 155893, 155896 thru 155942, 155944 thru 155973, 155977, 155979 thru 15600, 201001 thru 201021, 201023, 201025 thru 201028, 201031 thru 201052, 201056 thru 201060, 201150, 201156, 201377, 201458
- SPEC. 18** 155790, 155791, 201147, 201148, 201153, 201168, 201351, 201425, 201426, 201434, 201459, 201551, 201552
- SPEC. 19** 201063 thru 201075, 201077 thru 201082, 201085 thru 201146, 201157 thru 201167, 201171 thru 201199, 201200 thru 201215, 201218, 201219, 201222 thru 201269, 201272 thru 201305, 201308 thru 201347, 201349, 201350, 201352 thru 201357, 201359 thru 201366, 201378 thru 201393, 201395, 201404 thru 201424, 201429 thru 201433, 201435 thru 201453, 201455, 201456, 201465 thru 201505, 201508 thru 201521, 201532, 201533, 201534, 201550, 201604, 201678, 201679
- SPEC. 21** 201523 thru 201527, 201529, 201530, 201535, 201536 thru 201549, 201553 thru 201575, 201577 thru 201595, 201597, 201598, 201600 thru 201602, 201605 thru 201671, 201674, 201675, 201677, 201680 thru 201724

IO-470-M

- SPEC. 1** 93001 thru 93028, 93031 thru 93199, 93200 thru 93216, 93228 thru 93232, 93235

IO-470-N

- SPEC. 1** 95001 thru 95251, 95253 thru 95446, 95453 thru 95455, 95458 thru 95491, 95493, 95494, 95496 thru 95502, 95504 thru 95512, 95514 thru 95625, 95627 thru 95649, 95651 thru 95780, 95784 thru 95789, 95792 thru 95799, 95800, 95801, 95802, 95809, 95810, 95811, 95813 thru 95832, 95834, 95835, 95836, 95838
- SPEC. 7** 95650, 95839 thru 95850, 95898, 95901, 95912
- SPEC. 10** 95851 thru 95894, 95813
- SPEC. 11** 95895, 95896, 95897, 96899, 95900, 95902 thru 95911, 95913 thru 95916

IO-470-S

- SPEC. 1** 102001 thru 102275, 102532, 102997
- SPEC. 2** 102276 thru 102297, 102301 thru 102323, 102329 thru 102357, 102360 thru 102363, 102365, 102368 thru 102425, 102427, 102428, 102433, 102434, 102440, 102443, 102444, 102446, 102449, 102451, 102452, 102454, 102456, 102457, 102461 thru 102472, 102477 thru 102482, 102492 thru 102497, 102503 thru 102507, 102510 thru 102528, 102530, 102531, 102533 thru 102535, 102537 thru 102539, 102541 thru 102544, 102546, 102547, 102555 thru 102569, 102589 thru 102610, 102619 thru 102632, 102635, 102644 thru 102664, 102668 thru 102671, 102675, 102677 thru 102695, 102700 thru 102707, 102709, 102712, 102714 thru 102755, 102761 thru 102768, 102774 thru 102785, 102792, 102794, 102796, 102798, 102800 thru 102820, 102822 thru 102825, 102827, 102836 thru 102842, 102844 thru 102870, 102872 thru 102879, 102881 thru 102883, 102886 thru 102901, 102912, 102914, 102919 thru 102937, 102939 thru 102959, 102961 thru 102967, 102969, 102970, 102994, 102995, 102999, 103002, 103005 thru 103009, 103011, 103013 thru 103018, 103020, 103021, 103023, 103025 thru 103028
- SPEC. 3** 102298 thru 102300, 102324 thru 102328, 102358, 102359, 102364, 102366, 102367, 102426, 102429, 102430, 102432, 102441, 102442, 102445, 102447, 102448, 102449, 102450, 102453, 102455, 102458 thru 102460, 102473 thru 102476, 102483 thru 102491, 102508, 102509, 102536, 102578 thru 102586, 102611 thru 102618, 102633, 102634, 102636 thru 102643, 102665 thru 102667, 102672 thru 102674, 102708, 102710, 102711, 102713, 102756 thru 102760, 102769 thru 102773, 102786 thru 102791, 102793, 102795, 102797, 102799, 102821, 102826, 102828 thru 102835, 102843, 102871, 102880, 102990, 102996, 103001, 103003, 103004, 103010, 103019, 103022, 103024, 103030
- SPEC. 4** 102435 thru 102439, 102498 thru 102502, 102529, 102540, 102545, 102548 thru 102554, 102570 thru 102577, 102587, 102588, 102884, 102885, 102902 thru 102911, 102913, 102915 thru 102918

IO-470-U

- SPEC. 1** 115001 thru 115738, 115740 thru 115742, 115744 thru 115792, 115808 thru 115836, 115839 thru 115847, 115854 thru 115864, 115866 thru 115873, 115875, 115884, 115886, 115888, 115890 thru 115907, 115909 thru 115912, 115915, 115916, 115918 thru 115929, 115933 thru 115936

IO-470-V

- SPEC. 1** 147001 thru 147099, 147101 thru 147360, 147362 thru 147493, 147497, 147498, 147511, 147519, 147562 thru 147564, 147846, 147851, 147937, 147938, 147948, 147949, 147951, 147953, 147956, 147971, 147977, 148906
- SPEC. 2** 147494 thru 147496, 147499 thru 147510, 147512 thru 147518, 147520 thru 147561, 147565 thru 147706, 147708 thru 147845, 147847 thru 147850, 147852 thru 147936, 147939 thru 147947, 147950, 147952, 147954, 147955, 147957 thru 147970, 147972 thru 147976, 147978 thru 147987, 147990 thru 148001, 148877, 148898
- SPEC. 6** 149235, 149301, 149395, 149579
- SPEC. 8** 147988, 147989, 148002 thru 148093, 148095 thru 148386, 148391 thru 148395, 148398 thru 148403, 148405, 148406, 148417, 148420 thru 148422, 148427 thru 148433, 148468, 148511, 148512
- SPEC. 9** 148900 thru 148905, 148907 thru 148974, 148976 thru 148997, 148999 thru 149079, 149083 thru 149118, 149121 thru 149234, 149236 thru 149299, 149302 thru 149328, 149331 thru 149359, 149362 thru 149394, 149397 thru 149445, 149447 thru 149450, 149452 thru 149501, 149503 thru 149555, 149558 thru 149578, 149580 thru 149647
- SPEC. 10** 148975, 148998, 149080 thru 149082, 149119, 149120, 149300, 149329, 149330, 149360, 149361, 149396, 149446, 149451, 149502, 149556, 149557

SECTION II
GROUP ASSEMBLY PARTS LIST

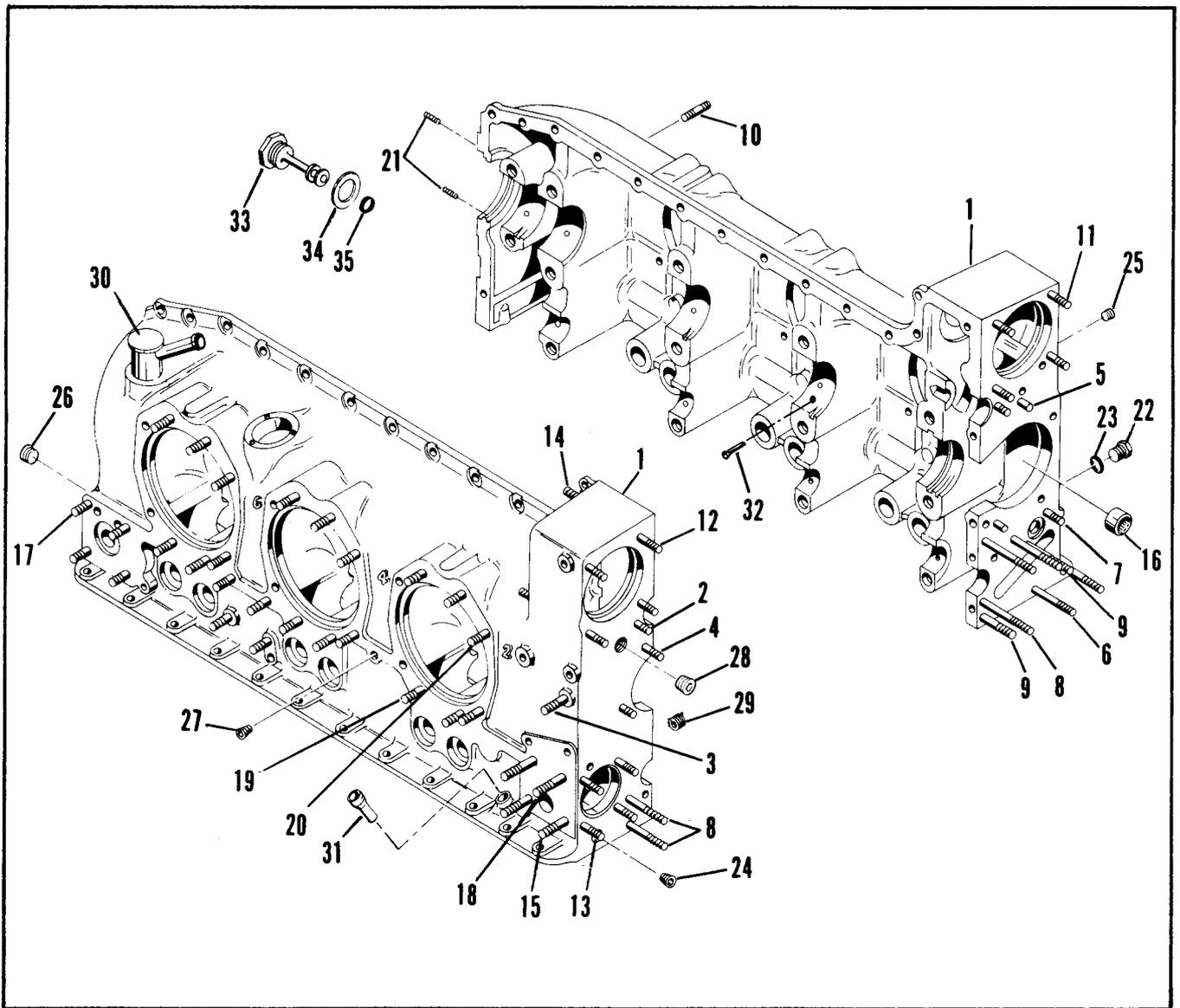

FIGURE 1. CRANKCASE STUDDING ASSEMBLY
 MODELS O-470-A,B,E,G,J,K,L,M,P,R,S

FIG. & INDEX	PART NUMBER	DESCRIPTION	QUANTITY PER ASSEMBLY																	
			A	B	E	G	J	K	L	M	P	R	S							
1-	539501	* Crankcase Studding Assembly		1																
	539734	* Crankcase Studding Assembly			1															
	641213	** Crankcase Studding Assembly				1							1							
	641186	@ * Crankcase Studding Assembly	1					1	1											
	641226	Crankcase Studding Assembly								1										
	641270	Crankcase Studding Assembly										1								
	641185	Crankcase Studding Assembly																	1	
	641373	Crankcase Studding Assembly																		1
- 1	No Number	. Crankcase Assembly	ns	ns	ns	ns	ns	ns	ns	ns	ns	ns	ns	ns	ns	ns	ns	ns	ns	ns
- 2	401963	† . Stud, 1/4 X 1 Inch Long	2		2	2	2	2	2	2	2	2	2	2	2	2	2	2	2	2
- 2	401870	† . Stud, 1/4 X 1-1/8 Inch Long		2									2							
- 3	402042	† . Stud, 5/16 X 1 Inch Long			1		1						1	1						
- 4	401885	† . Stud, 5/16 X 1-5/16 Inch Long	2	2	2	2	2	2	2	2	2	2	2	2	2	2	2	2	2	2
- 5	531548	. Dowel	2	2	2	2	2	2	2	2	2	2	2	2	2	2	2	2	2	2

FIG. & INDEX	PART NUMBER	DESCRIPTION	QUANTITY PER ASSEMBLY													
			A	B	E	G	J	K	L	M	P	R	S			
1- 6	402129	† . Stud, 1/4 X 2-3/4 Inch Long	2	2	2	2	2	2	2	2	2	2	2	2	2	2
- 7	401893	† . Stud, 1/4 X 1-1/4 Inch Long	1	1	1	1	1	1	1	1	1	1	1	1	1	2
- 8	402056	† . Stud, 1/4 X 3-9/16 Inch Long	5	5		5	5	5	5	5	5	5	5	5	5	5
- 8	537422	† . Stud, 1/4 X 3-9/16 Inch Long			5											
- 9	531649	† . Stud, 1/4 X 3-1/4 Inch Long		2												
- 9	401886	† . Stud, 1/4 X 3-3/16 Inch Long	2		2	2	2	2	2	2	2	2	2	2	2	2
-10	22320	† . Stud, 1/4 X 2-1/16 Inch Long			5											
-10	401841	† . Stud, 1/4 X 2-3/32 Inch Long	5			3	5	5	3			3	3	3	3	3
-10	401870	† . Stud, 1/4 X 1-1/8 Inch Long				2			2			2	2	2	2	2
-10	401808	† . Stud, 1/4 X 1-5/16 Inch Long		5							5					
-11	401885	† . Stud, 5/16 X 1-5/15 Inch Long	6	6	6	6	6	6	6	6	6	6	6	6	6	6
-12	401965	† . Stud, 3/8 X 1-13/32 Inch Long		2												
-12	402153	† . Stud, 3/8 X 1-5/16 Inch Long	2		2	2	2	2	2	2	2	2	2	2	2	2
-13	401814	† . Stud, 5/16 X 1-7/8 Inch Long			4											4
-13	532507	† . Stud, 5/16 X 1-7/8 Inch Long		4		4					4	4				
-13	22324	† . Stud, 5/16 X 1-3/8 Inch Long	4				4	4								
-13	401809	† . Stud, 5/16 X 1-3/8 Inch Long							4					4	4	4
-14	401885	† . Stud, 5/16 X 1-5/16 Inch Long	4	4	4	4	4	4	4	4	4	4	4	4	4	4
-15	401861	† . Stud, 3/8 X 1-25/32 Inch Long	15	15	15		15	15	15		7		15	15	15	15
-15	401945	† . Stud, 3/8 X 1-5/8 Inch Long									8					
-16	537721	. Bearing, Needle	1	1	1	1	1	1	1	1	1	1	1	1	1	1
-17	401814	† . Stud, 5/16 X 1-7/8 Inch Long	4	4	4	4	4	4	4	4	4	4	4	4	4	4
-18	401861	† . Stud, 3/8 X 1-25/32 Inch Long	1	1	1		1	1	1	1	1	1	1	1	1	1
-19	639418-2	† . Stud, 7/16 X 1-19/32 Inch Long	12	24	12	12	12	12	12	12	12	12	12	12	12	12
-20	639418-1	† . Stud, 7/16 X 2-1/16 Inch Long	24	12	24	24	24	24	24	24	24	24	24	24	24	24
-21	535956	† . Stud, No. 10 X 5/8 Inch Long				4	4	4	4	4	4	4	4	4	4	4
-22	532432	. Plug, Drilled Hex Head, 5/8-18	1	1	1	1	1	1	1	1	1	1	1	1	1	1
-23	AN900-10	& . Gasket, Annular	1	1	1	1	1	1	1	1	1	1	1	1	1	1
-24	629518-1	. Plug, Pipe, 1/8 NPT	1	1	1	1	1	1	1	1	1	1	1	1	1	1
-25	629518-1	. Plug, Pipe, 1/8 NPT	1	1	1	1	1	1	1	1	1	1	1	1	1	1
-26	2025	. Plug, Pipe, 3/8 NPT	7	4	6	4	4	4	4	4	4	4	4	4	4	4
-27	629518-3	. Plug, Pipe, 3/8 NPT		1	1	1	1	1	1	1	1	1	1	1	1	1
-28	629518-3	. Plug, Pipe, 3/8 NPT	1	1	1	1	1	1	1	1	1	1	1	1	1	1
-29	MS122162	. Insert,	4	4	4	4	4	4	4	4	4	4	4	4	4	4
-29	MS122122	. Insert	1	1	1	1	1	1	1	1	1	1	1	1	1	1
-30	537505	. Breather Assembly, Crankcase	1	1	1	1	1	1	1	1	1	1	1	1	1	1
-31	537297	. Guide, Oil Gauge Rod	1	1	1		1	1	1	1						
-31	631927	. Guide, Oil Gauge Rod													1	
-32	629847	. Nozzle, Squirt														6
-33	626334	Plug, Special									1	1				
-34	625966	& Gasket									1	1				
-35	AN123866	& Seal, O-Ring									1	1				

NOTE: * Crankcases for Models O-470-A, -B, -E, -J can be supplied with 1/2" thru bolts by ordering 625566A1 Crankcase Kit if engine model is specified on your order.

** For early model O-470-G engines not equipped with oil transfer collars, order 628783A1 Crankcase and Collar Kit.

@ See Section VI For Specification Applications.

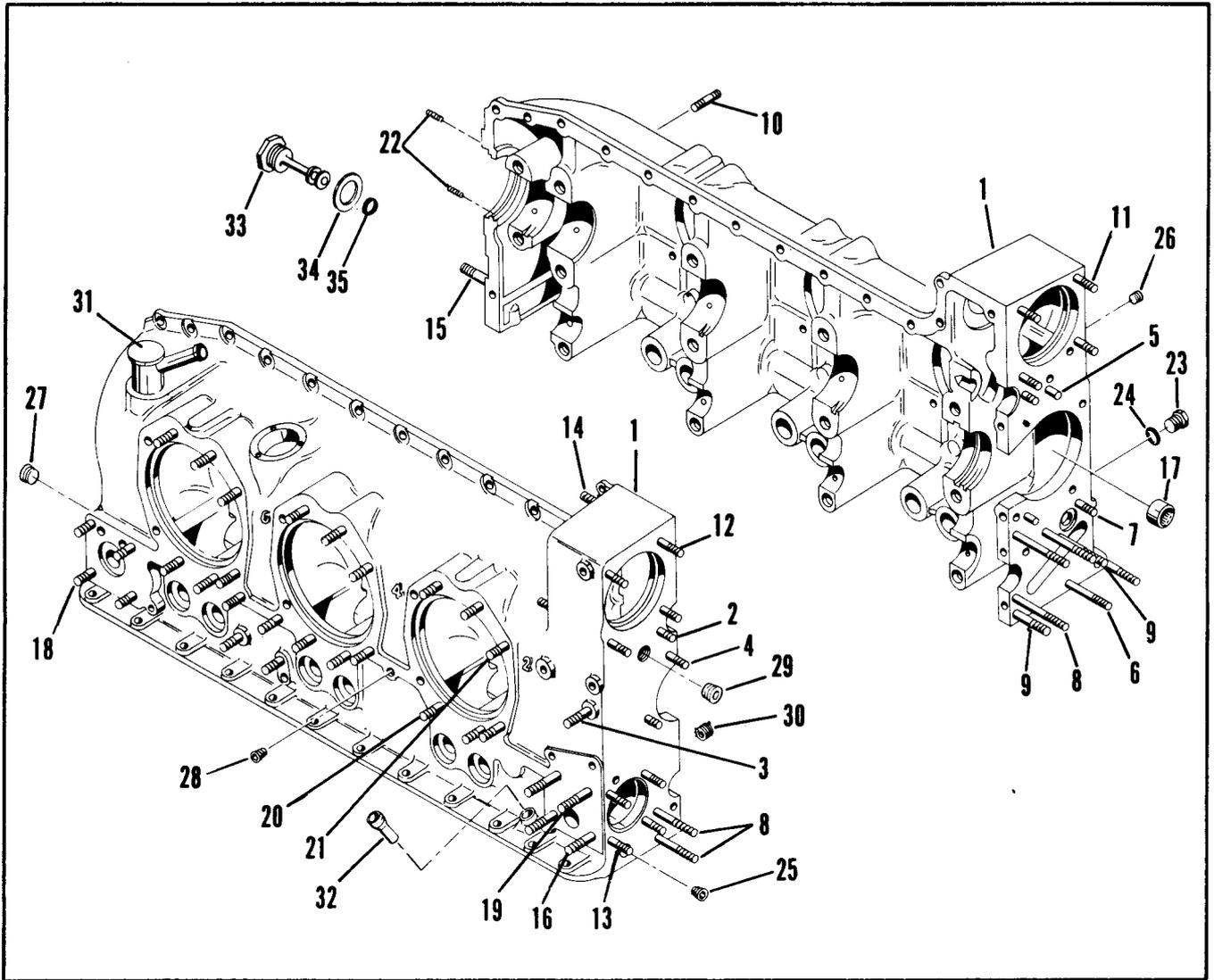

FIGURE 2. CRANKCASE STUDDING ASSEMBLY
 MODELS 10-470-C, D, E, F, G, H, J, K, L, M, N, P, R, S, U, V

FIG. & INDEX	PART NUMBER	DESCRIPTION	QUANTITY PER ASSEMBLY															
			C	D	E	F	G	H	J	K	L	M	N	P	R	S	U	V
2-	641213	Crankcase Studding Assembly	1	1						1								1
	641192	Crankcase Studding Assembly			1		1										1	1
	641191	@ Crankcase Studding Assembly				1												
	641273	Crankcase Studding Assembly						1						1				
	641214	Crankcase Studding Assembly							1									
	641189	@ Crankcase Studding Assembly									1							
	641197	Crankcase Studding Assembly										1						
	629887	Crankcase Studding Assembly												1				
	641206	@ Crankcase Studding Assembly																1
- 1	No Number	. Crankcase Assembly	ns	ns	ns	ns	ns	ns	ns	ns	ns	ns	ns	ns	ns	ns	ns	ns
- 2	401963	† . Stud, 1/4 X 1 Inch Long	2			2		2	2	2		2	2					
- 2	401870	† . Stud, 1/4 X 1-1/8 Inch Long		2	2		2				2			2	2	2	2	2
- 3	402042	† . Stud, 5/16 X 1 Inch Long	1			1		1	1	1			1					
- 3	401881	† . Stud, 5/16 X 1-1/8 Inch Long		1	1		1							1	1	1	1	1

FIG. & INDEX	PART NUMBER	DESCRIPTION	QUANTITY PER ASSEMBLY															
			C	D	E	F	G	H	J	K	L	M	N	P	R	S	U	V
2- 4	401885	† . Stud, 5/16 X 1-5/16 Inch Long	2	2	2	2	2	2	2	2	2	2	2	2	2	2	2	2
- 5	531548	. Dowel	2	2	2	2	2	2	2	2	2	2	2	2	2	2	2	2
- 6	402129	† . Stud, 1/4 X 2-3/4 Inch Long	2	2	2	2	2	2	2	2	2	2	2	2	2	2	2	2
- 7	401893	† . Stud, 1/4 X 1-1/4 Inch Long	1	1		1		1	1	1	1		1		1	1	1	1
- 7	22319	† . Stud, 1/4 X 1-1/4 Inch Long			1		1					1		1	1		1	1
- 8	402056	† . Stud, 1/4 X 3-9/16 Inch Long	5	5		5		5	5	5	5		5		5	5		5
- 8	537422	† . Stud, 1/4 X 3-9/16 Inch Long			5		5					5		5	5		5	5
- 9	AN126132	† . Stud, 1/4 X 3-3/8 Inch Long			2		2					2		2	2		2	2
- 9	401886	† . Stud, 1/4 X 3-3/16 Inch Long	2	2		2		2	2	2	2		2		2	2		2
-10	401841	† . Stud, 1/4 X 2-3/32 Inch Long	3		3	5	3	3	3	3			3	3	3	3		3
-10	401870	† . Stud, 1/4 X 1-1/8 Inch long	2		2		2		2	2				2	2		2	2
-10	401808	† . Stud, 1/4 X 1-5/16 Inch Long		5								5	5				5	5
-10	401801	† . Stud, 1/4 X 1-3/16 Inch Long						2										2
-11	401885	† . Stud, 5/16 X 1-5/16 Inch Long	6	6	6	6	6	6	6	6	6	6	4	6	6	6	6	6
-11	401895	† . Stud, 5/16 X 2-7/16 Inch Long											2					2
-12	401965	† . Stud, 3/8 X 1-13/32 Inch Long			2		2	2					2	2	2	2		2
-12	402153	† . Stud, 3/8 X 1-5/16 Inch Long	2	2		2			2	2	2						2	2
-13	401814	† . Stud, 5/16 X 1-7/8 Inch Long														4		4
-13	532507	† . Stud, 5/16 X 1-7/8 Inch Long	4	4	4	4	4	4	4	4	4	4	4	4	4			4
-13	402151	† . Stud, 5/16 X 1-1/4 Inch Long																2
-14	401885	† . Stud, 5/16 X 1-5/16 Inch Long	4	4	4	4	4	4	4	4	4	4	4	4	4	4	4	4
-15	402162	† . Stud, 7/16 X 3-1/4 Inch Long														2		2
-16	401861	† . Stud, 3/8 X 1-25/32 Inch Long		7	15	15	15					14	15		15	15	7	7
-16	401945	† . Stud, 3/8 X 1-5/8 Inch Long		8													8	8
-16	402066	† . Stud, 3/8 X 1-7/8 Inch Long										1						1
-17	537721	. Bearing, Needle	1	1	1	1	1	1	1	1	1	1	1	1	1	1	1	1
-18	401814	† . Stud, 5/16 X 1-7/8 Inch Long	4	4		4		4		4	4		4		4	4		4
-18	401809	† . Stud, 5/16 X 1-3/8 Inch Long							4									4
-18	532507	† . Stud, 5/16 X 1-3/8 Inch Long			4		4					4		4	4			4
-19	401861	† . Stud, 3/8 X 1-25/32 Inch Long		1	1	1	1					1		1	1	1	1	1
-19	401819	† . Stud, 3/8 X 1-15/16 Inch Long									1							1
-20	639418-2	† . Stud, 7/16 X 1-19/32 Inch Long	12	12	12	12	12	12	12	12	12	12	12	12	24	12	12	12
-21	639418-1	† . Stud, 7/16 X 2-1/16 Inch Long	24	24	24	24	24	24	24	24	24	24	24	24	12	24	24	24
-22	535956	† . Stud, No. 10 X 5/8 Inch Long	4	4	4	4	4	4	4	4	4	4	4	4	4		4	4
-23	532432	† . Plug, Drilled Hex Head, 5/8-18	1	1	1	1	1	1	1	1	1	1	1	1	1	1	1	1
-24	AN900-10	& . Gasket, Annular	1	1	1	1	1	1	1	1	1	1	1	1	1	1	1	1
-25	629518-1	. Plug, Drilled Sq.Hd. Pipe, 1/8 NPT	1	1	1	1	1	1	1	1	1	1	1	1	1	1	1	1
-26	629518-1	. Plug, Drilled Sq.Hd.Pipe, 1/8 NPT	1	1	1	1	1	1	1	1	1	1	1	1	1	1	1	1
-27	2025	. Plug, Pipe, 3/8 NPT	4	4	4	4	4	4	4	4	4	4	4	4	4	4	4	4
-28	629518-3	. Plug, Pipe, 3/8 NPT	1	1	1	1	1	1	1	1	1	1	1	1	1	1	1	1
-29	629518-3	. Plug, Pipe, 3/8 NPT	1	1	1	1	1	1	1	1	1	1	1	1	1	1	1	1
-30	MS122162	. Insert	4	4	4	4	4	4	4	4	4	4	4	4	4	4	4	4
-30	MS122122	. Insert	1	1	1	1	1	1	1	1	1	1	1	1	1	1	1	1
-31	537505	. Breather Assembly, Crankcase	1	1	1	1	1	1	1	1	1	1	1	1	1	1	1	1
-32	537297	. Guide, Oil Gauge Rod		1	1	1	1					1		1	1	1	1	1
-33	626334	Plug, Special		1								1	1					1
-34	625966	& Gasket, Special		1								1	1					1
-35	AN123866	& Seal, O-Ring		1								1	1					1

@ See Section VI For Specification Applications.

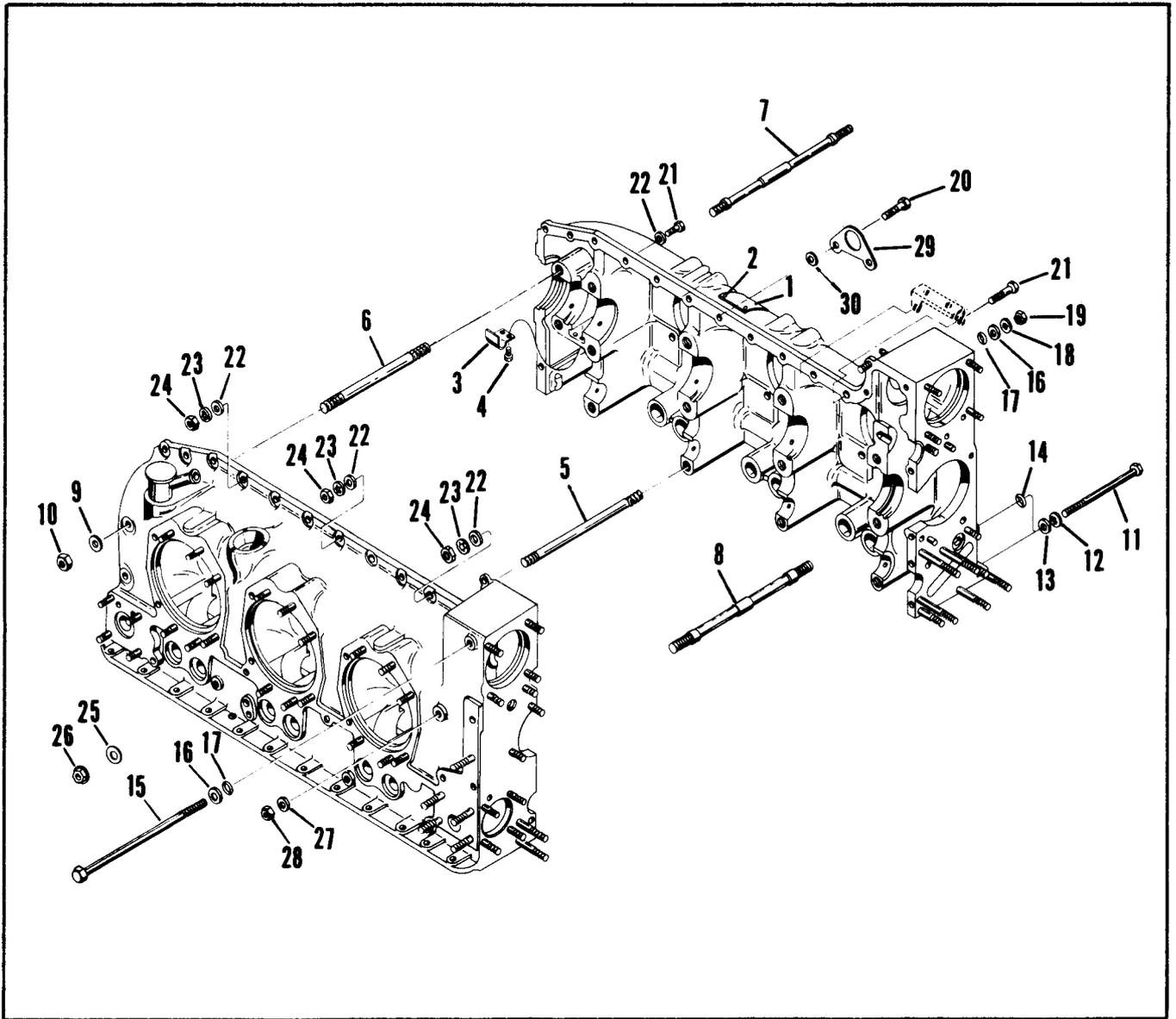

FIGURE 3. CRANKCASE ATTACHING PARTS
 MODELS O-470-A, B, E, G, J, K, L, M, P, R, S

FIG. & INDEX	PART NUMBER	DESCRIPTION	QUANTITY PER ASSEMBLY																	
			A	B	E	G	J	K	L	M	P	R	S							
3- 1	629939	* Plate, Identification			1															
- 1	534947	* Plate, Identification	1																	
- 1	534948	* Plate, Identification		1																
- 1	634958	* Plate, Identification					1													
- 1	634956	* Plate, Identification				1														
- 1	634959	* Plate, Identification						1												
- 1	634960	* Plate, Identification							1											
- 1	634961	* Plate, Identification								1										
- 1	626640	* Plate, Identification									1									
- 1	634964	* Plate, Identification										1								
- 1	641390	* Plate, Identification																		1
ATTACHING PARTS																				
- 2	24764	Screw, Drive * * * *	6	6	6	6	6	6	6	6	6	6	6	6	6	6	6	6	6	6
- 3	626990	Clip, Spring ATTACHING PARTS				1							1							
- 4	AN500A10-4	Screw * * * *				2							2							
- 5	538944-10.50	Bolt, Crankcase Through	4	4	4	4	4	4	4	4	4	4	4	4	4	4	4	4	4	4
- 6	538944-8.88	Bolt, Crankcase Through	2	2	2	2	2	2	2	2	2	2	2	2	2	2	2	2	2	2
- 7	539050-9.81	Bolt, Crankcase Through	1	1	1	1	1	1	1	1	1	1	1	1	1	1	1	1	1	1
- 8	539050-10.75	Bolt, Crankcase Through	7	7	7	7	7	7	7	7	7	7	7	7	7	7	7	7	7	7
- 9	25171	Spacer, Crankcase Through Bolt	4	4	4	4	4	4	4	4	4	4	4	4	4	4	4	4	4	4
-10	531001	Nut, Flanged	4	4	4	4	4	4	4	4	4	4	4	4	4	4	4	4	4	4
-11	535709	Bolt	3	3	3	3	3	3	3	3	3	3	3	3	3	3	3	3	3	5
-12	MS35338-45	Washer, Lock	3	3	3	3	3	3	3	3	3	3	3	3	3	3	3	3	3	3
-13	2473	Washer, Plain, 5/16 Inch	3	3	3	3	3	3	3	3	3	3	3	3	3	3	3	3	3	4
-14	25328	& O-Ring	1	1	1	1	1	1	1	1	1	1	1	1	1	1	1	1	1	1
-14	AN123961	& O-Ring																		1
-15	535810	Bolt	1	1	1	1	1	1	1	1	1	1	1	1	1	1	1	1	1	1
-15	630693-10.44	Bolt																		1
-16	24239	Washer, Plain	2	2	2	2	2	2	2	2	2	2	2	2	2	2	2	2	2	2
-17	AN123862	& O-Ring	2	2	2	2	2	2	2	2	2	2	2	2	2	2	2	2	2	2
-18	MS35338-46	Washer, Lock	1	1	1	1	1	1	1	1	1	1	1	1	1	1	1	1	1	1
-19	2441	Nut, Plain Hex, 3/8	1	1	1	1	1	1	1	1	1	1	1	1	1	1	1	1	1	2
-20	AN5-13A	Bolt	2	1	1	1														
-21	AN5-14A	Bolt	2	2	2	2	2	2	2	2	3	2	2	2	2	2	2	2	2	2
-21	AN5-12A	Bolt	11	11	10	9	10	10	10	10	10	11	10	10	10	10	10	10	10	10
-22	2473	Washer, Flat	22	22	23	23	23	23	23	23	23	22	23	23	23	23	23	23	23	23
-23	MS35338-45	Washer, Lock	13	13	13	13	13	13	13	13	13	13	13	13	13	13	13	13	13	13
-24	2439	Nut, Plain Hex	13	13	13	13	13	13	13	13	13	13	13	13	13	13	13	13	13	13
-25	25171	Spacer	8	8	8	8	8	8	8	8	8	8	8	8	8	8	8	8	8	8
-26	531001	Nut, Flanged, 7/16	8	8	8	8	8	8	8	8	8	8	8	8	8	8	8	8	8	8
-27	538989	Washer, Plain		4	4	4	4	3	4	4	4	4	4	4	4	4	4	4	4	4
-28	634511	Nut, Plain	4	4	4	4	4	3	4	4	4	4	4	4	4	4	4	4	4	4
-29	538650	Lifting Eye	1	1	1	1	1	1	1	1	1	1	1	1	1	1	1	1	1	1
-30	538949	Spacer, Crankcase-to-Lifting Eye	2	2	2	2	2	2	2	2	2	2	2	2	2	2	2	2	2	2

* Orders for Identification Plates must be accompanied by old plate.

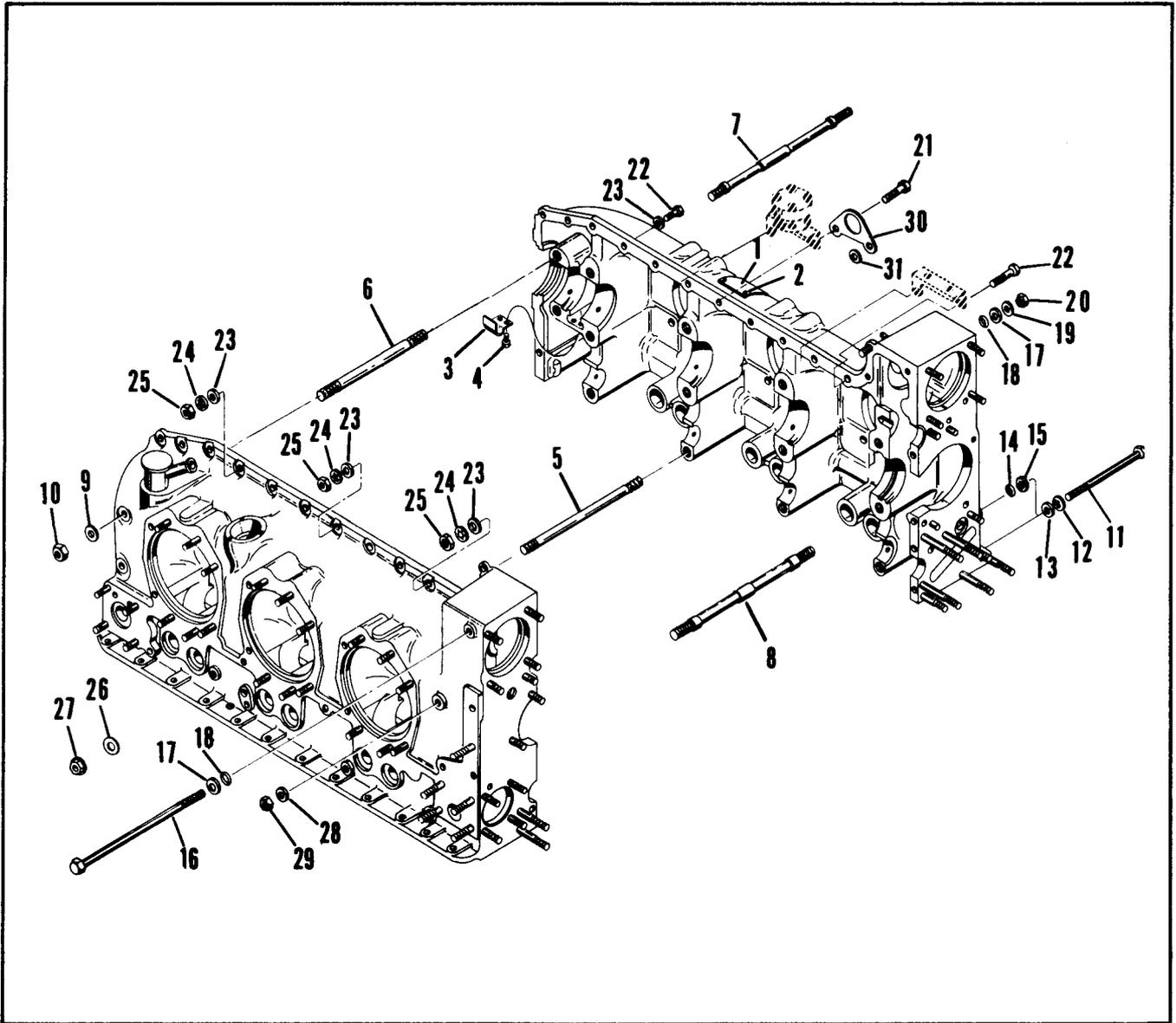

FIGURE 4. CRANKCASE ATTACHING PARTS
 MODELS 10-470-C, D, E, F, G, H, J, K, L, M, N, P, R, S, U, V

FIG. & INDEX	PART NUMBER	DESCRIPTION	QUANTITY PER ASSEMBLY																							
			C	D	E	F	G	H	J	K	L	M	N	P	R	S	U	V								
4- 1	634919	* Plate, Identification	1																							
- 1	634920	* Plate, Identification		1																						
- 1	634921	* Plate, Identification			1																					
- 1	634922	* Plate, Identification				1																				
- 1	634924	* Plate, Identification					1																			
- 1	628207	* Plate, Identification						1																		
- 1	634964	* Plate, Identification																							1	
- 1	634925	* Plate, Identification									1															
- 1	634926	* Plate, Identification										1														
- 1	634927	* Plate, Identification											1													
- 1	634928	* Plate, Identification												1												
- 1	634929	* Plate, Identification													1											
- 1	629511	* Plate, Identification																						1		

FIG. & INDEX	PART NUMBER	DESCRIPTION	QUANTITY PER ASSEMBLY																
			C	D	E	F	G	H	J	K	L	M	N	P	R	S	U	V	
4- 1	634932	* Plate, Identification																1	
- 1	634934	* Plate, Identification																	1
- 1	634935	* Plate, Identification																	1
		ATTACHING PARTS																	
- 2	24764	Screw, Drive * * * *	6	6	6	6	6	6	6	6	6	6	6	6	6	6	6	6	6
- 3	626990	Clip, Spring ATTACHING PARTS	1	1	1	1	1	1	1	1	1	1	1	1	1	1	1	1	1
- 4	AN500A10-4	Screw * * * *	2	2	2	2	2	2	2	2	2	2	2	2	2	2	2	2	2
- 5	538944-10.50	Bolt, Crankcase Through	4	4	4	4	4	4	4	4	4	4	4	4	4	4	4	4	4
- 6	538944-8.88	Bolt, Crankcase Through	2	2	2	2	2	2	2	2	2	2	2	2	2	2	2	2	2
- 7	539050-9.81	Bolt, Crankcase Through	1	1	1	1	1	1	1	1	1	1	1	1	1	1	1	1	1
- 8	634504-10.75	Bolt, Crankcase Through	7	7	7	7	7	7	7	7	7	7	7	7	7	7	7	7	7
- 9	25171	Spacer, Crankcase Through Bolt	4	4	4	4	4	4	4	4	4	4	4	4	4	4	4	4	4
-10	531001	Nut, Flanged	4	4	4	4	4	4	4	4	4	4	4	4	4	4	4	4	4
-11	535709	Bolt	4						4	4									
-12	627433	Bolt, Drilled Hex Head		4	4	4	4	4			4	4	4	5	4	4	4	4	
-12	MS35338-45	Washer, Lock	4	4	4	4	4	4	4	4	4	4	4	5	4	4	4	4	
-13	2473	Washer, Plain	3	3	3	3	3	3	3	3	3	3	3	3	3	3	3	3	4
-14	25328	& O-Ring	1	1	1	1	1	1	1	1	1	1	1	1	1	1	1	1	1
-15	401506	Washer	1	1	1	1	1	1	1	1	1	1	1	1	1	1	1	1	1
-16	535810	Bolt	1	1	1	1	1	1	1	1	1	1	1	1	1	1	1	1	1
-17	24239	Washer, Plain	2	2	2	2	2	2	2	2	2	2	2	2	2	2	2	2	2
-18	AN123862	& O-Ring	2	2	2	2	2	2	2	2	2	2	2	2	2	2	2	2	2
-19	MS35338-46	Washer, Lock	1	1	1	1	1	1	1	1	1	1	1	1	1	1	1	1	1
-20	2441	Nut, Plain Hex, 3/8 Inch	1	1	1	1	1	1	1	1	1	1	1	1	1	1	1	1	1
-21	AN5-13A	Bolt	1	1	1	1	1	1	1	1	1	1	1	1	1	1	1	1	1
-22	AN5-14A	Bolt	2	2	2	2	2	2	2	2	2	2	2	2	2	2	2	2	2
-22	AN5-12A	Bolt	9	9	9	9	9	9	9	10	9	9	9	10	9	9	9	9	9
-23	2473	Washer, Flat	23	23	23	23	23	23	23	23	23	23	23	23	23	23	23	23	23
-24	MS35338-45	Washer, Lock	13	13	13	13	13	13	13	13	13	13	13	13	13	13	13	13	13
-25	2439	Nut, Plain Hex	13	13	13	13	13	13	13	13	13	13	13	13	13	13	13	13	13
-26	25171	Spacer	8	8	8	8	8	8	8	8	8	8	8	8	8	8	8	8	8
-27	531001	Nut, Flanged	8	8	8	8	8	8	8	8	8	8	8	8	8	8	8	8	8
-28	538989	Washer, Plain	4	4	4	4	4	4	4	4	4	4	4	4	4	4	4	5	4
-29	539952	Nut, Plain	4	4	4	4	4	4	4	4	4	4	4	4	4	4	4	5	4
-30	538650	Lifting Eye	1	1	1	1	1	1	1	1	1	1	1	1	1	1	1	1	1
-31	538949	Spacer, Crankcase-to-Lifting Eye	1	1	1	1	1	1	1	1	1	1	1	1	1	1	1	1	1

* Orders for Identification Plates must be accompanied by old plate.

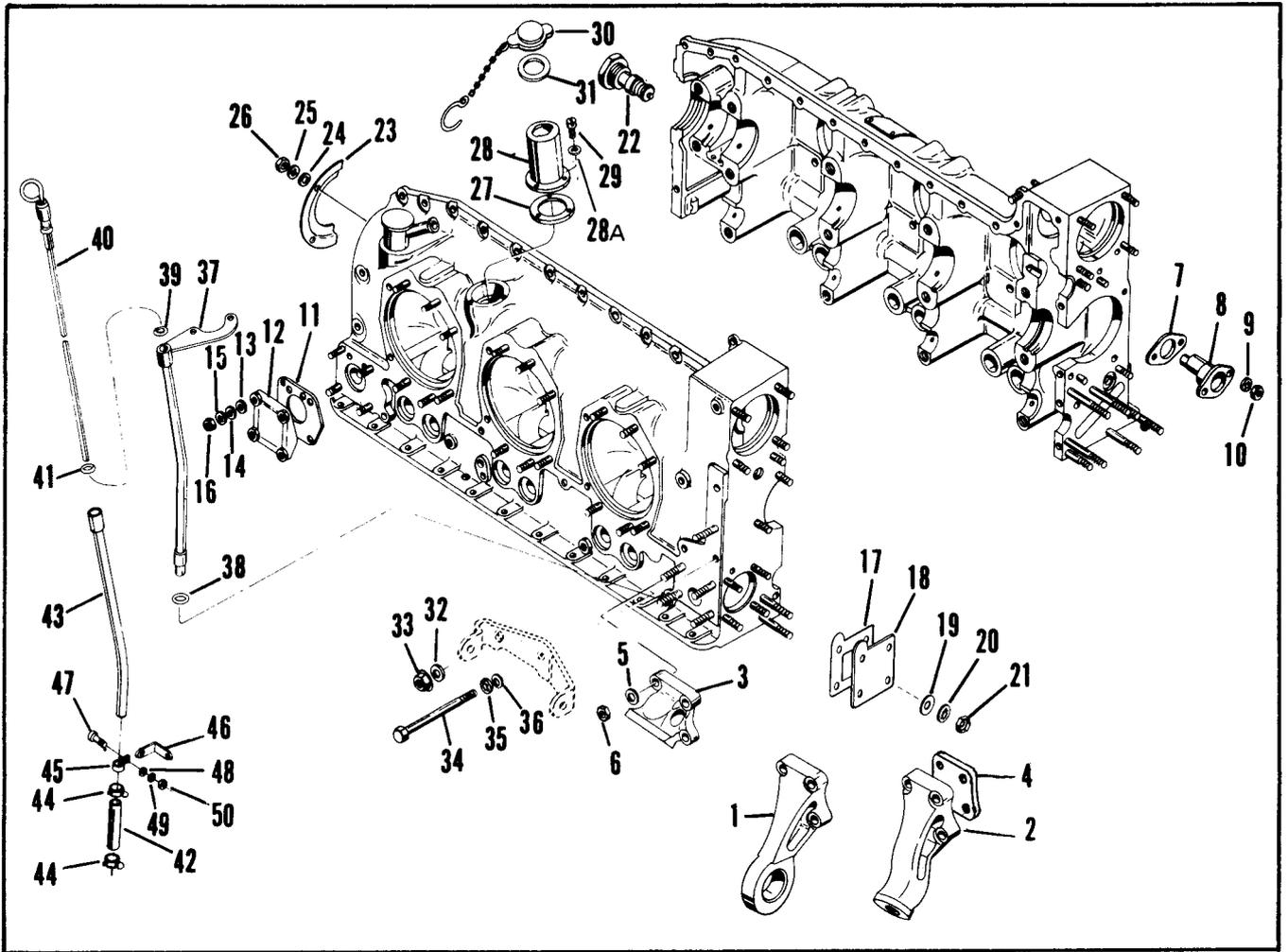

FIGURE 5. CRANKCASE ASSOCIATED PARTS
 MODELS O-470-A, B, E, G, J, K, L, M, P, R, S

FIG. & INDEX	PART NUMBER	DESCRIPTION	QUANTITY PER ASSEMBLY																	
			A	B	E	G	J	K	L	M	P	R	S							
5- 1	534470	@ Bracket, Engine Mounting	4	4	4		4													
- 2	539518	@ Bracket, Engine Mounting								4	4									4
- 2	628257	@ Bracket, Engine Mounting, Cyl. #2																		3
- 3	539914	@ Bracket, Engine Mounting											4							1
		ATTACHING PARTS																		
- 4	632357	Spacer																		1
- 5	539058	Washer, Plain	16	16	16		16	16	16	16	16	16	16	16	16	16	16	16	16	16
- 6	2441	Nut, Plain Hex	16	16	16		16	16	16	16	16	16	16	16	16	16	16	16	16	16
		* * * *																		
- 7	534740	& Gasket	1	1	1	1	1	1	1	1	1	1	1	1	1	1	1	1	1	1
- 8	534728	Pin, Idler Gear Support	1	1	1	1	1	1	1	1	1	1	1	1	1	1	1	1	1	1
		ATTACHING PARTS																		
- 9	MS35338-44	Washer, Lock	2	2	2	2	2	2	2	2	2	2	2	2	2	2	2	2	2	2
-10	2437	Nut, Plain	2	2	2	2	2	2	2	2	2	2	2	2	2	2	2	2	2	2
		* * * *																		
-11	531083	& Gasket	1	1	1	1	1	1	1	1	1	1	1	1	1	1	1	1	1	1
-12	639997	Cover, Governor Pad	1	1	1	1	1	1	1	1	1	1	1	1	1	1	1	1	1	1
		ATTACHING PARTS																		
-13	22535	Washer, 5/16 Inch	4	4	4	4	4	4	4	4	4	4	4	4	4	4	4	4	4	4
-14	2473	Washer, Flat	4	4	4	4	4	4	4	4	4	4	4	4	4	4	4	4	4	4
-15	MS35338-45	Washer, Lock	4	4	4	4	4	4	4	4	4	4	4	4	4	4	4	4	4	4

FIG. & INDEX	PART NUMBER	DESCRIPTION	QUANTITY PER ASSEMBLY												
			A	B	E	G	J	K	L	M	P	R	S		
5-16	2439	Nut, Plain * * * *	4	4	4	4	4	4	4	4	4	4	4	4	4
-17	534941	& Gasket	1				1	1	1					1	1
-18	534942	Cover, Fuel Pump Pad	1				1	1	1					1	1
		ATTACHING PARTS													
-19	2473	Washer, Flat	4				4	4	4					4	4
-20	MS35338-45	Washer, Lock	4				4	4	4					4	4
-21	2439	Nut, Plain * * * *	4				4	4	4					4	4
-22	534445	Vernatherm Control Valve	1												
-22	639304	Vernatherm Control Valve		1	1	1	1	1	1	1	1	1	1	1	1
-23	626963	Retainer, Oil Seal	2	2	2	2	2	2	2	2	2	2	2	2	2
		ATTACHING PARTS													
-24	AN960-10L	Washer, Flat	4	4	4	4	4	4	4	4	4	4	4	4	4
-25	20654	Washer, Lock	4	4	4	4	4	4	4	4	4	4	4	4	4
-26	13XX1896	Nut, Plain, No. 10 * * * *	4	4	4	4	4	4	4	4	4	4	4	4	4
-27	538804	& Gasket	1	1	1	1	1	1	1	1	1	1	1	1	1
-28	538773	Neck Assembly, Oil Filler	1		1		1	1	1					1	1
-28	538801	Neck Assembly, Oil Filler		1		1					1	1			
		ATTACHING PARTS													
-28A	MS35338-44	Washer, Lock													3
-29	AN500A416-8	Screw * * * *	3	3	3	3	3	3	3	3	3	3	3	3	3
-30	640620	Cap and Retainer Assembly		1		1					1	1			
-30	640620-8	Cap and Retainer Assembly												1	1
-30	640620-12	Cap Assembly	1		1		1	1	1						
-31	535823	Gasket	1	1	1	1	1	1	1	1	1	1	1	1	1
-32	2794	Washer, 17/32	1	1	1	1	1	1	1	1	1	1	1	1	1
-33	538969	Nut, Flanged	1	1	1	1	1	1	1	1	1	1	1	1	1
-34	535709	Bolt, 5/16 X 5-1/4 Inch Long	1	1	1	1	1	1	1	1	1	1	1	1	1
-35	AN936A516	Washer, Lock	1	1	1	1	1	1	1	1	1	1	1	1	1
-36	2473	Washer, Plain	1	1	1	1	1	1	1	1	1	1	1	1	1
-37	625213	Tube Assembly, Oil Gauge Rod				1						1			
-38	AN123865	& O-Ring				1						1			
-39	537299	Ring, Oil Gauge Lock	1	1	1	1	1	1	1	1	1	1	1	1	1
-40	**	Rod Assembly, Oil Gauge	1	1	1	1	1	1	1	1	1	1	1	1	1
-41	AN123860	& O-Ring	1	1	1	1	1	1	1	1	1	1	1	1	1
-42	631928	Hose												1	1
-43	632151	Housing												1	1
-44	36151R	Clamp												2	2
-45	631266-1	Clamp												1	1
-46	632149	Bracket												1	1
		ATTACHING PARTS													
-47	22904	Screw												1	1
-48	2471	Washer, Plain												1	1
-49	22910	Washer, Lock												1	1
-50	13XX1896	Nut, No. 10												1	1

** To order oil gauge rod assembly, supply engine model, name of airplane and year manufactured.

@ See Section VI For Specification Applications.

FIG. & INDEX	PART NUMBER	DESCRIPTION	QUANTITY PER ASSEMBLY																
			C	D	E	F	G	H	J	K	L	M	N	P	R	S	U	V	
6-15	MS35338-45	Washer, Lock	4	4	4	4	4	4	4	4	4	4	4	4	4	4	4	4	
-16	2439	Nut	4	4	4	4	4	4	4	4	4	4	4	4	4	4	4	4	
		* * * *																	
-17	534445	Vernatherm Control Valve															1		
-17	639304	Vernatherm Control Valve	1		1	1	1	1	1	1			1	1	1				
-18	626963	Retainer, Oil Seal	2	2	2	2	2	2	2	2	2			2	2	2	2		
-18	639642	Retainer, Oil Seal											2				2		
		ATTACHING PARTS																	
-19	AN960-10L	Washer, Flat	4	4	4	4	4	4	4	4	4	4	4	4	4	4	4		
-20	22910	Washer, Lock	4	4	4	4	4	4	4	4	4	4	4	4	4	4	4		
-21	13XX1896	Nut, Plain, No. 10	4	4	4	4	4	4	4	4	4	4	4	4	4	4	4		
		* * * *																	
-22	538804	& Gasket	1	1	1	1	1	1	1	1	1	1	1	1	1	1	1		
-23	538773	Neck Assembly, Oil Filler				1													
-23	538801	Neck Assembly, Oil Filler		1	1		1	1				1		1	1	1	1		
-23	627166	Neck Assembly, Oil Filler	1						1	1	1		1						
		ATTACHING PARTS																	
-24	AN500A416-8	Screw	3	3	3	3	3	3	3	3	3	3	3	3	3	3	3		
		* * * *																	
-25	640620	Cap and Retainer Assembly	1	1	1	1	1	1	1	1	1	1	1	1	1	1	1		
-26	535823	Gasket	1	1	1	1	1	1	1	1	1	1	1	1	1	1	1		
-27	MS35338-45	Washer, Lock	1	1	1	1	1	1	1	1	1	1	1	1	1	1	1		
-28	2473	Washer, 11/32	1	1	1	1	1	1	1	1	1	1	1	1	1	1	1		
-29	2439	Nut, 5/16	1	1	1	1	1	1	1	1	1	1	1	1	1	1	1		
-30	2794	Washer, 17/32		1	1		1					1		1	1	1	1		
-31	538969	Nut, Flanged, 1/2			1		1				1	1		1	1	1	1		
-32	535709	Bolt	1						1	1									
-32	627433	Bolt		1	1	1	1	1			1	1	1	1	1	1	1		
-33	MS35338-45	Washer, Lock	1	1	1	1	1	1	1	1	1	1	1	1	1	1	1		
-34	2473	Washer, Plain	1	1	1	1	1	1	1	1	1	1	1	1	1	1	1		
-35	625213	Tube Assembly, Oil Gauge Rod Guide						1											
-36	627164	Tube Assembly, Oil Gauge Rod Guide	1						1	1			1						
-36	628543	Tube Assembly, Oil Gauge Rod Guide									1								
-36	AN123865	& O-Ring	1					1	1	1	1		1						
-37	537299	Ring, Oil Gauge Lock	1	1	1	1	1	1	1	1	1	1	1	1	1	1	1		
-38	**	Rod Assembly, Oil Gauge	1	1	1	1	1	1	1	1	1	1	1	1	1	1	1		
-39	AN123860	& O-Ring	1	1	1	1	1	1	1	1	1	1	1	1	1	1	1		
-40	25328	& O-Ring															1		
-40	631928	* Hose															1		
-41	631915	* Housing, Extension															1		
-42	36151R	* Clamp															2		
-43	631266-1	* Clamp															1		
-44	631275-1	* Bracket															1		
		ATTACHING PARTS																	
-45	22904	* Screw															1		
-46	2471	* Washer, Plain															1		
-47	22910	Washer, Lock															1		
-48	13XX1896	Nut, No. 10															1		
		* * * *																	

* These parts shipped loose.
 ** To order oil gauge rod assembly, supply engine model, name of airplane and year manufactured.
 @ See Section VI For Specification Applications.

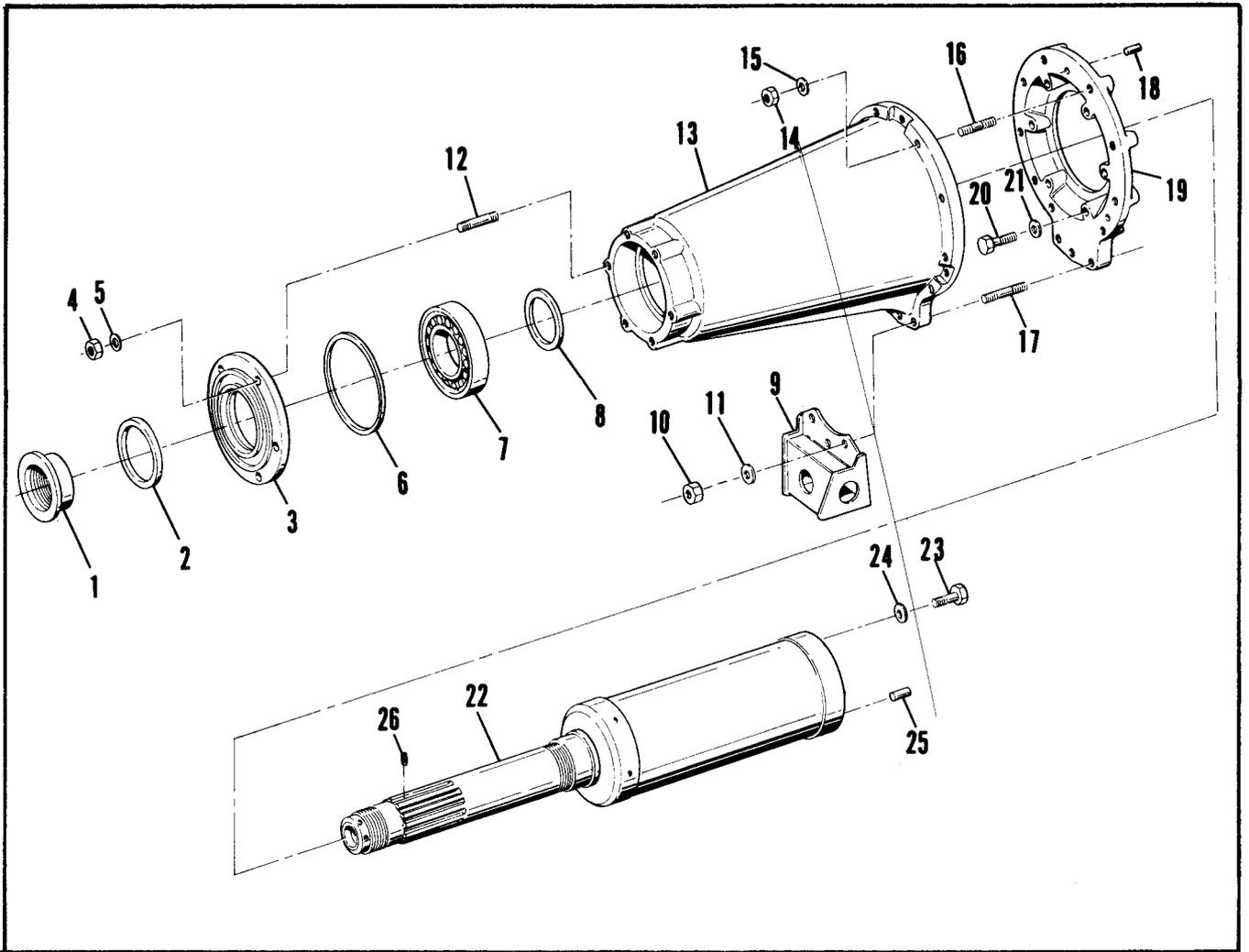

FIGURE 7. CRANKCASE AND CRANKSHAFT EXTENSION ASSEMBLIES
MODEL 10-470-P

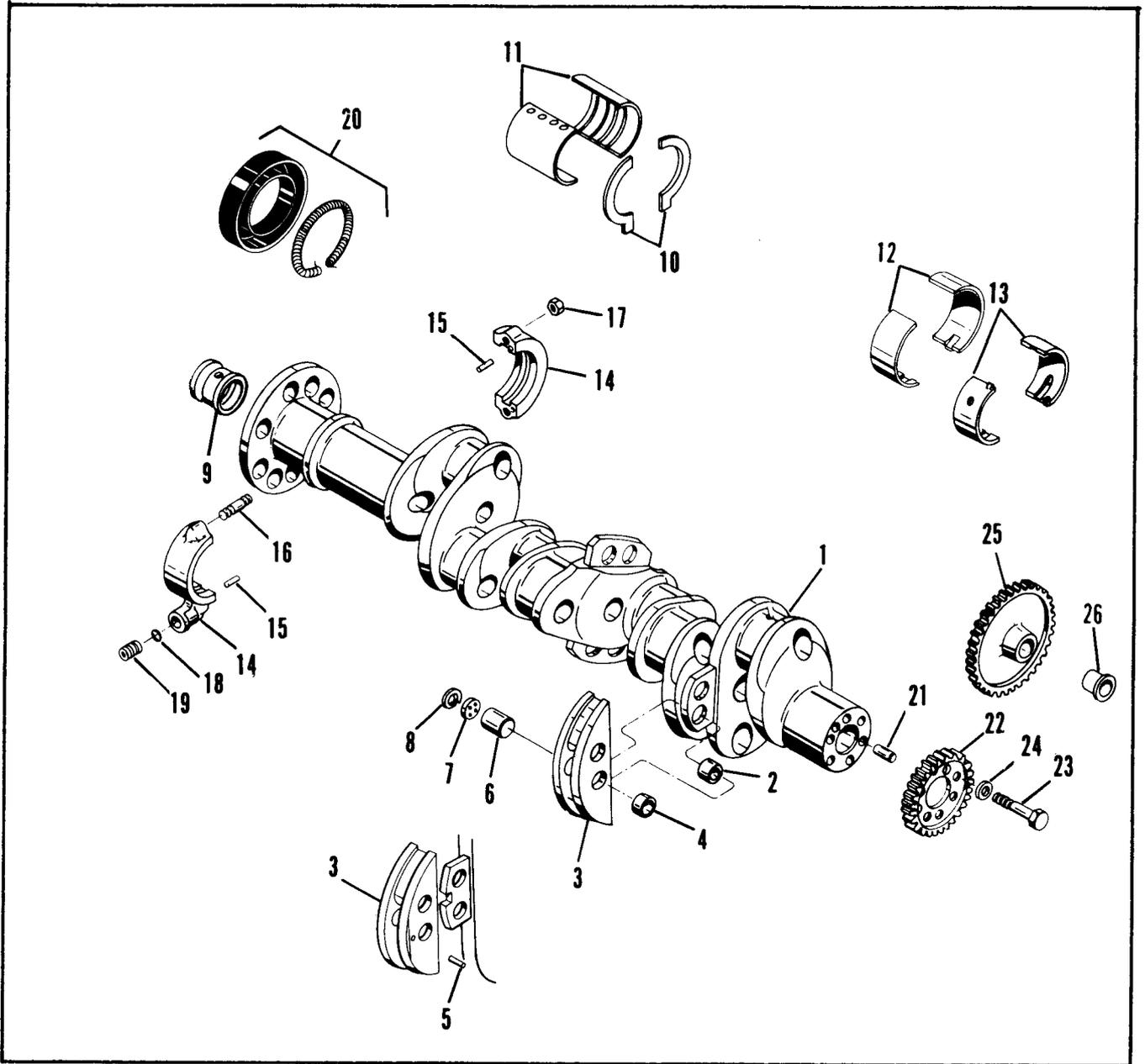

FIGURE 8. CRANKSHAFT ASSEMBLY
 MODELS O-470-A, B, E, G, J, K, L, M, P, R, S

FIG. & INDEX	PART NUMBER	DESCRIPTION	QUANTITY PER ASSEMBLY													
			A	B	E	G	J	K	L	M	P	R	S			
8-	633225	Crankshaft and Damper Assembly	1		1		1								1	1
	633227	Crankshaft and Damper Assembly		1												
	633256	Crankshaft, Damper & Oil Transfer Assy				1										
	633219	Crankshaft and Damper Assembly						1	1	1						
	633258	Crankshaft, Damper & Oil Transfer Assy													1	
- 1	No Number	. Crankshaft Assembly	ns	ns	ns	ns	ns	ns	ns	ns	ns	ns	ns	ns	ns	ns
- 2	350998	† . Bushing, Crankshaft Damper	4	4	4	4	4	8	8	8	8	8	4	4		
	639195	. Counterweight Assembly	2	2	2		2	4	4	4	4	4	2	2		
	639197	. Counterweight Assembly				2										
- 3	No Number	. . Counterweight	ns	ns	ns	ns	ns	ns	ns	ns	ns	ns	ns	ns	ns	ns
- 4	639193	† . . Bushing, Counterweight	4	4	4	4	4	4	4	4	4	4	4	4	4	4
- 5	X1794B	. Pin	1	1	1		1									
- 6	630261-2	. Pin		4		2										
- 6	630261-37	. Pin	2		2		2						2	2		
- 6	630261-35	. Pin	2		2		2	8	8	8	8	8	2	2		
- 6	630261-5	. Pin				2										
- 7	635623	. Plate	8	8	8	8	8	16	16	16	16	16	8	8		
- 8	629104	. Snap, Ring	8	8	8	8	8	16	16	16	16	16	8	8		
- 9	633189	. Plug, Oil Control	1	1	1	1	1	1	1	1	1	1	1	1	1	1
-10	628136	Thrust Washer	4	4	4	4	4	4	4	4	4	4	4	4	4	4
-11	633136	&† Bearing, Main, Front	2	2	2		2	2	2	2	2	2	2	2	2	2
-12	530386	&† Bearing, Main	6		6	2	6	6	6			2	6	6		
-12	630464	&† Bearing, Main		6		8					6	8				
-13	530383 *	† Bearing, Connecting Rod	12	12	12	12	12	12	12	12	12	12	12	12		
-13	628750	† Bearing, Connecting Rod	12	12	12	12	12	12	12	12	12	12	12	12	12	12
-14	626739	† Collar Assembly					1						1			
-15	626889	. Dowel				2							2			
-16	401893	† . Stud, 1/4 X 1-1/4 Inch Long				2							2			
-17	632443-4	. Nut, Marsden Lock				2							2			
-18	AN123965	& O-Ring				1							1			
-19	626890	Sleeve, Oil Transfer				1							1			
-20	641250	Oil Seal Assembly	1	1	1	1	1	1	1	1	1	1	1	1	1	1
-21	536563	† Dowel	1	1	1	1	1	1	1	1	1	1	1	1	1	1
-22	536421	Gear, Crankshaft	1	1	1	1	1	1	1	1	1	1	1	1	1	1
		ATTACHING PARTS														
-23	536379	Screw, Drilled Hex Head	6	6	6	6	6	6	6	6	6	6	6	6	6	6
-24	X1454	Washer, Plain	1	1	1	1	1	1	1	1	1	1	1	1	1	1
		* * * *														
-25	534757	Gear Assembly, Idler	1	1	1	1	1	1	1	1	1	1	1	1	1	1
-26	534741	. Bushing, Idler	1	1	1	1	1	1	1	1	1	1	1	1	1	1

NOTE: O-470-G engines with modernized crankshafts require two (2) each 627024 front main and six (6) each 537848 rear and intermediate bearings.

* Use Bearing 530383 with Rod Assembly A36121.

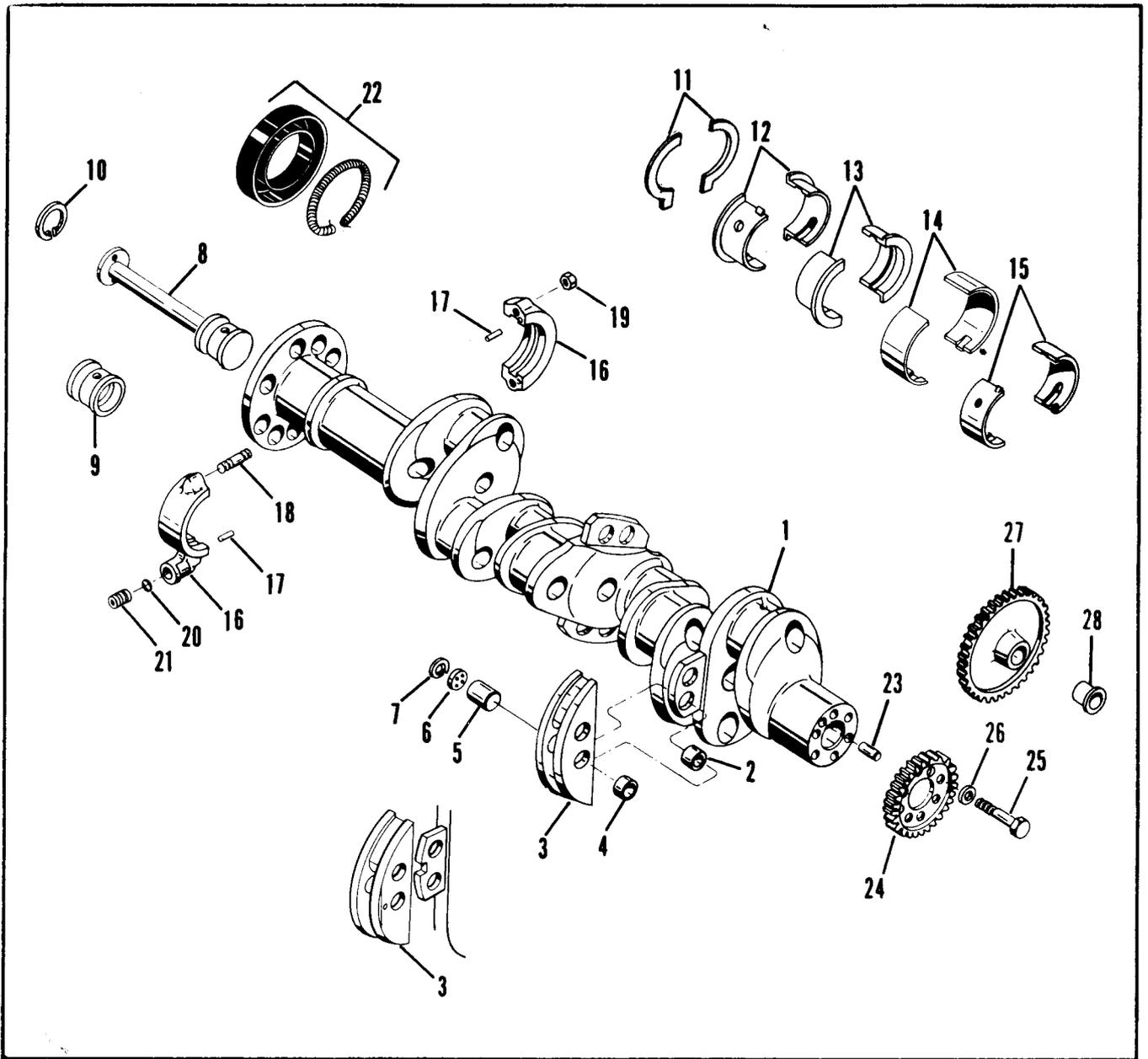

FIGURE 9. CRANKSHAFT ASSEMBLY
 MODELS 10-470-C, D, E, F, G, H, J, K, L, M, N, P, R, S, U, V

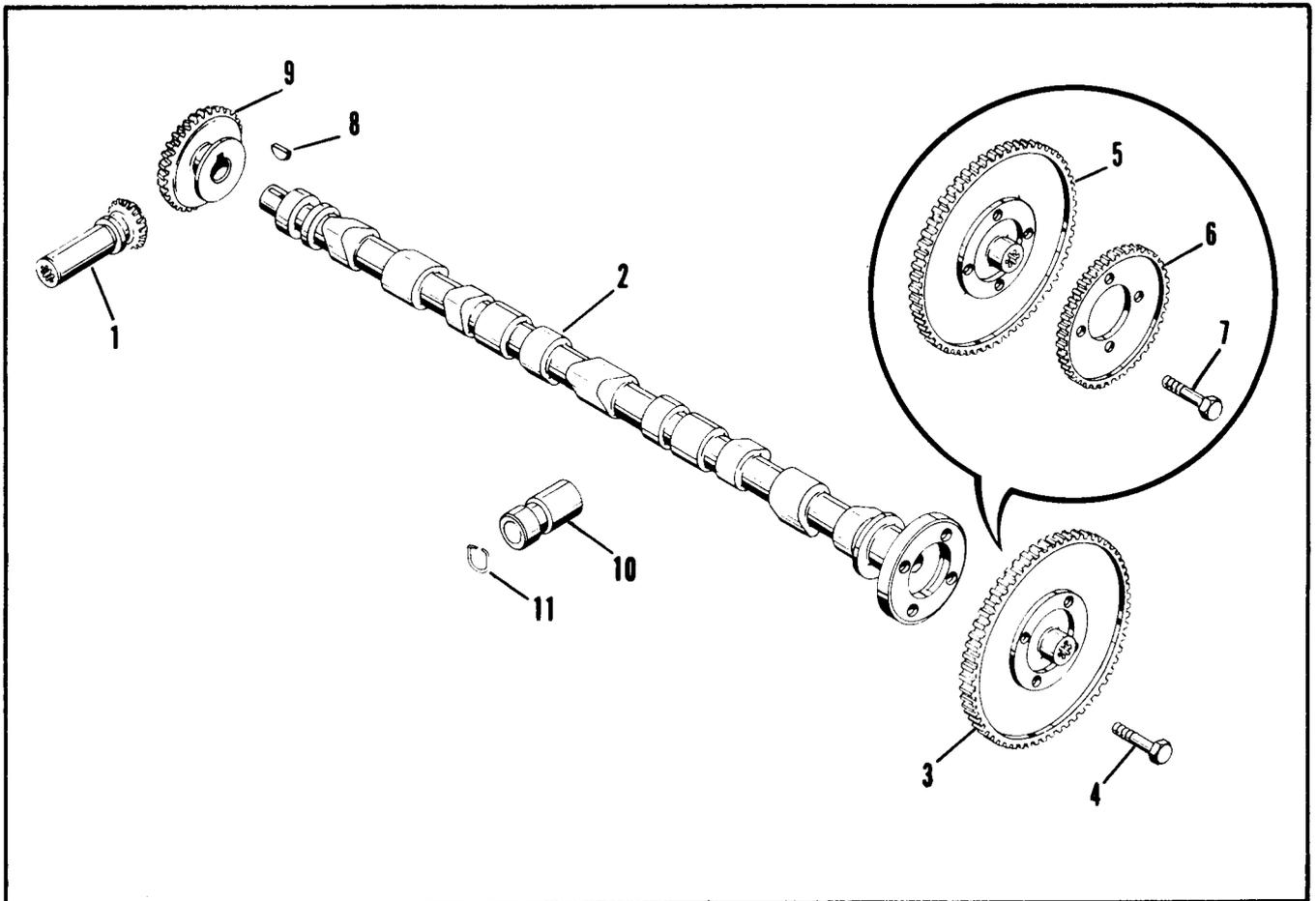

FIGURE 10. CAMSHAFT ASSEMBLY
MODELS O-470-A, B, E, G, J, K, L, M, P, R, S

FIG. & INDEX	PART NUMBER	DESCRIPTION	QUANTITY PER ASSEMBLY												
			A	B	E	G	J	K	L	M	P	R	S		
10- 1	538076	Gear, Governor Drive Bevel	1	1	1	1	1	1	1	1	1	1	1	1	1
- 2	535661	† Camshaft	1	1	1	1	1	1	1	1	1	1	1	1	1
- 3	535660	Gear, Camshaft	1		1		1	1						1	1
ATTACHING PARTS															
- 4	535737	Screw, Drilled Hex Head * * * *	4					4	4	4				4	4
- 5	537432	Gear, Camshaft			1						1	1			
- 6	535662	Gear, Cam Cluster			1	1						1	1		
ATTACHING PARTS															
- 7	535666	Screw, Drilled Hex Head * * * *	4	4	4							4	4		
- 8	MS35756-8	Key, Woodruff	1	1	1	1	1	1	1	1	1	1	1	1	1
- 9	534655	Gear, Governor Drive	1	1	1	1	1	1	1	1	1	1	1	1	1
-10	628488	Lifter Assembly, Hydraulic	12			12		12	12	12	12	12	12	12	12
-10	628489	Lifter Assembly, Hydraulic	12			12									
-11	628491	Ring, Snap	1	1	1	1	1	1	1	1	1	1	1	1	1

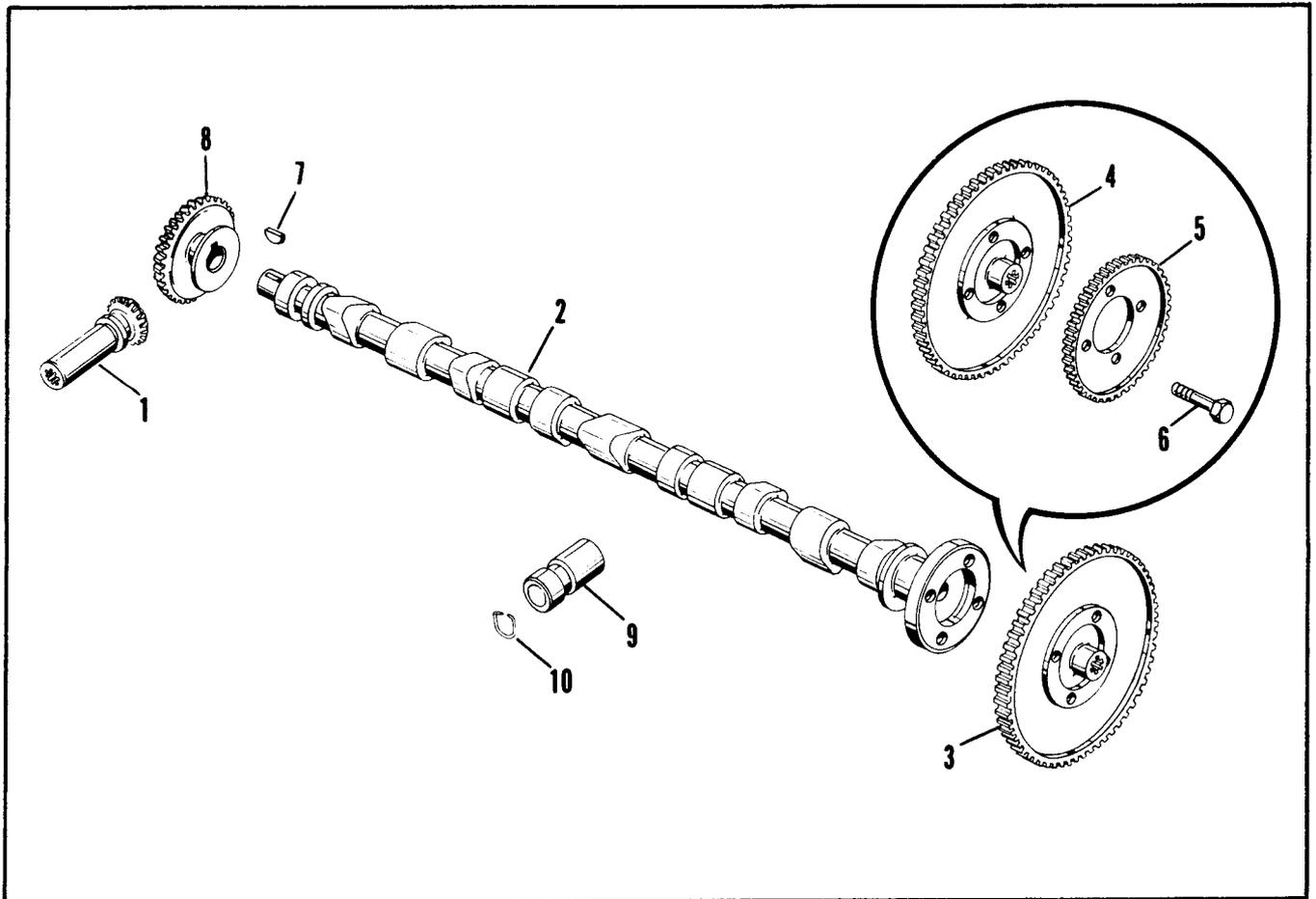

FIGURE 11. CAMSHAFT ASSEMBLY
 MODELS 10-470-C, D, E, F, G, H, J, K, L, M, N, P, R, S, U, V

FIG. & INDEX	PART NUMBER	DESCRIPTION	QUANTITY PER ASSEMBLY																
			C	D	E	F	G	H	J	K	L	M	N	P	R	S	U	V	
11- 1	538076	Gear, Governor Drive Bevel	1	1	1	1	1	1	1	1	1	1	1	1	1	1	1	1	1
- 2	535661	† Camshaft	1	1	1	1	1	1	1	1	1	1	1	1	1	1	1	1	1
- 3	535660	Gear, Camshaft							1	1									
- 4	537432	Gear, Camshaft	1	1	1	1	1	1				1	1	1	1	1	1		
- 4	631845	Gear, Camshaft																1	1
- 5	535662	Gear, Cam Cluster	1	1	1	1	1	1	1	1	1	1	1	1	1	1	1	1	1
		ATTACHING PARTS																	
- 6	535666	Screw, Drilled Hex Head * * * *	4	4	4	4	4	4	4	4	4	4	4	4	4	4	4	4	4
- 7	MS35756-8	Key, Woodruff	1	1	1	1	1	1	1	1	1	1	1	1	1	1	1	1	1
- 8	534655	Gear, Governor Drive	1	1	1	1	1	1	1	1	1	1	1	1	1	1	1	1	1
- 9	628488	Lifter Assembly, Hydraulic	12	12	12	12	12	12				12	12	12	12	12	12	12	12
- 9	628489	Lifter Assembly, Hydraulic							12	12									
-10	628491	Ring, Snap	1	1	1	1	1	1	1	1	1	1	1	1	1	1	1	1	1

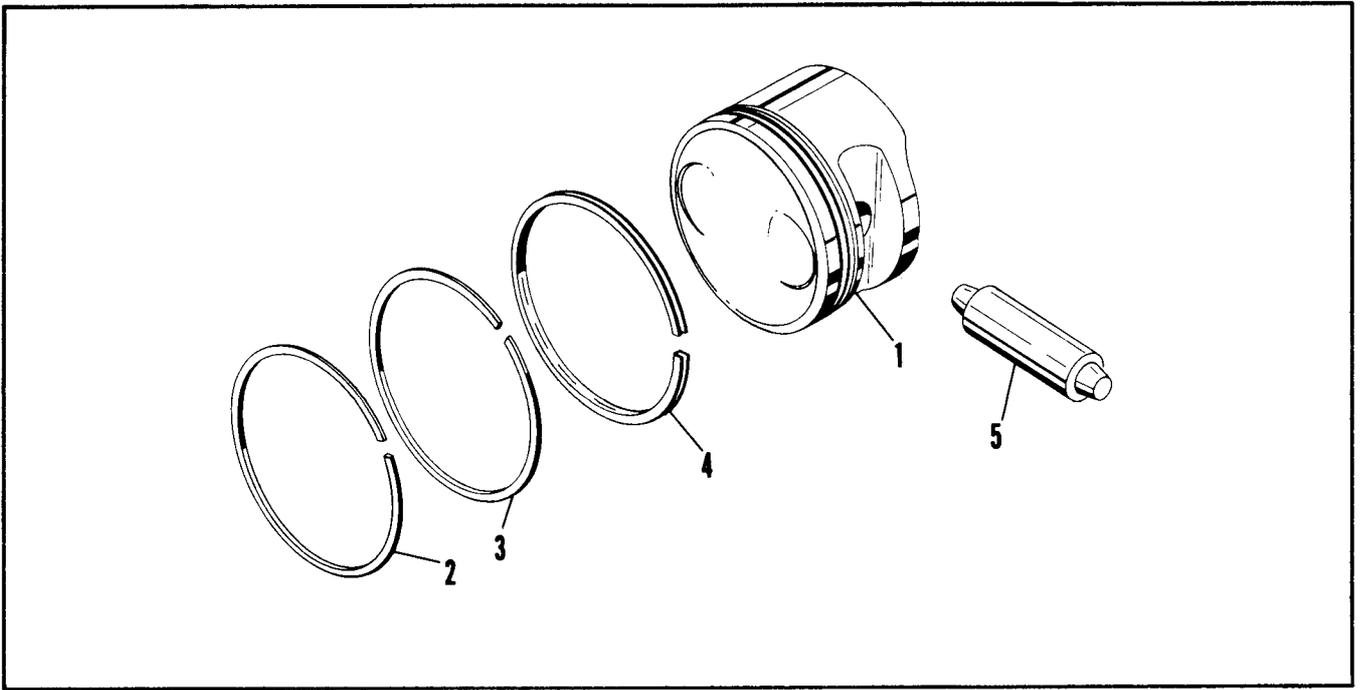

FIGURE 12. PISTON AND RING ASSEMBLY

MODELS O-470-A, B, E, G, J, M, P

FIG. & INDEX	PART NUMBER	DESCRIPTION	QUANTITY PER ASSEMBLY																	
			A	B	E	G	J	K	L	M	P	R								
12-	534895A19	Piston and Ring Assembly	6		6			6												
	537883A6	Piston and Ring Assembly		6									6	6						
	539814A7	Piston and Ring Assembly					6													
- 1	534895	† . Piston, 7:1 Compression Ratio	1		1			1												
- 1	537883	† . Piston, 8:1 Compression Ratio		1									1	1						
- 1	539814	† . Piston, 8:1 Compression Ratio						1												
- 2	639567	&† . Ring, Compression, Top Groove	1	1	1			1					1	1						
- 2	639566	&† . Ring, Compression, Top & 2nd Groove					2													
- 3	639568	&† . Ring, Compression, 2nd Groove	1	1	1			1					1	1						
- 4	639768	&† . Ring, Piston, Oil, Third Groove	1	1	1	1	1	1					1	1						
- 5	539467	† . Pin and Plug Assembly, Piston	1	1	1	1	1	1					1	1						

For Correct Rings to be Used with Chrome Cylinders, See Service Bulletin M75-18.

MODELS IO-470-C, G, J, K, P, R

FIG. & INDEX	PART NUMBER	DESCRIPTION	QUANTITY PER ASSEMBLY																		
			C	D	E	F	G	H	J	K	L	M	N	P	R	S	U	V			
12-	534895A7	Piston and Ring Assembly								6	6										
	539814A1	Piston and Ring Assembly	6				6									6	6				
- 1	534895	* † . Piston, 7:1 Compression Ratio								1	1										
- 1	539814	* † . Piston, 8:1 Compression Ratio	1				1														
- 2	625147	&† . Ring, Piston Compression, Top & Second Groove	2				2									2	2				
- 2	635557	&† . Ring, Piston Compression, Top Groove								1	1										
- 3	536938	&† . Ring, Piston Compression, Second Groove								1	1										
- 4	536939	&† . Ring, Piston, Oil, Third Groove	1				1			1	1					1	1				
- 5	539467	† . Pin and Plug Assembly, Piston	1				1			1	1					1	1				

See Service Bulletin M72-13 for Information on Reworking Ring Gap When Used with Normalized Cylinders

See Service Bulletin M75-18 for Rings to be Used with Chrome Cylinders

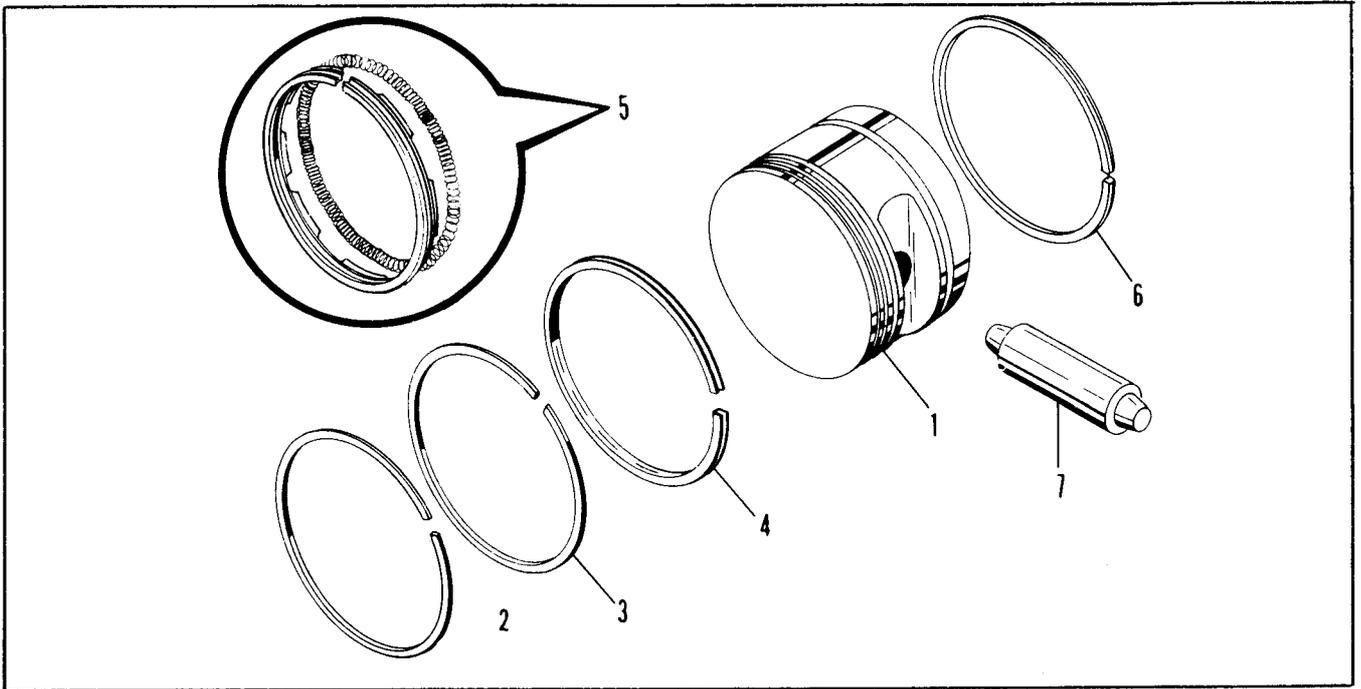

FIGURE 13. PISTON AND RING ASSEMBLY
MODELS O-470-K, L, R, S

FIG. & INDEX	PART NUMBER	DESCRIPTION	QUANTITY PER ASSEMBLY												
			A	B	E	G	J	K	L	M	P	R	S		
13-	640518A1	Piston and Ring Assembly													6
	632932A3	Piston and Ring Assembly							6	6				6	
- 1	640518	† . Piston, 7:1 Compression Ratio													1
- 1	632932	† . Piston, 7:1 Compression Ratio							1	1				1	
- 2	639567	&† . Ring, Piston, Top Groove							1	1				1	
- 2	639565	&† . Ring, Piston, Top Groove													1
- 3	536938	&† . Ring, Piston, Second Groove							1	1				1	
- 3	639566	&† . Ring, Piston, Second Groove													1
- 5	639663	&† . Ring, Piston, Third Groove							1	1				1	1
- 6	627480	&† . Ring, Piston, Fourth Groove							1	1				1	1
- 7	539467	† . Pin and Plug Assembly, Piston							1	1				1	1

See Service Bulletin M75-18 for Rings to be used with Chrome Cylinders

FIG. & INDEX	PART NUMBER	DESCRIPTION	QUANTITY PER ASSEMBLY												
			A	B	E	G	J	K	L	M	P	R			
13-	626992A1	Piston and Ring Assembly							6	6				6	
- 1	626992	*† . Piston, 7:1 Compression Ratio							1	1				1	
- 2	635557	&† . Ring, Piston, Top Groove							1	1				1	
- 3	536938	&† . Ring, Piston, Second Groove							1	1				1	
- 4	536939	&† . Ring, Piston, Third Groove							1	1				1	
- 6	627480	&† . Ring, Piston, Fourth Groove							1	1				1	
- 7	539467	† . Pin and Plug Assembly, Piston							1	1				1	

* Parts superseded and not replaceable by new parts except in complete sets.

Pistons identified by overall length. 627738 = 3.682 - 3.678 632932 = 3.79
631481 = 3.93 626992 = 3.54

See Service Bulletin M72-13 for information on reworking ring gap when used with normalized cylinders.

See Service Bulletin M75-18 for Rings to be used with Chrome Cylinders

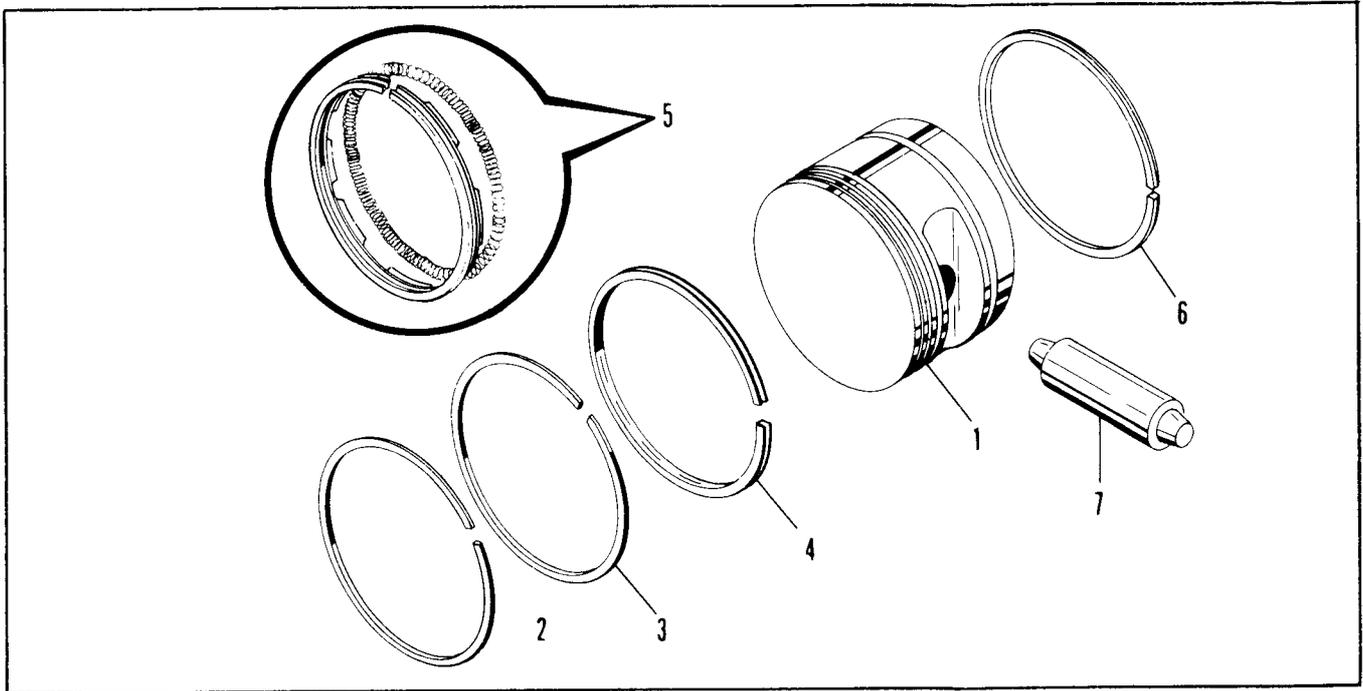

FIGURE 13A. PISTON AND RING ASSEMBLY
MODELS IO-470-D, E, F, H, L, M, N, S, U, V

FIG. & INDEX	PART NUMBER	DESCRIPTION	QUANTITY PER ASSEMBLY																	
			C	D	E	F	G	H	J	K	L	M	N	P	R	S	U	V		
13-	631481A1	Piston and Ring Assembly		6	6	6		6				6	6	6				6	6	6
- 1	631481	† . Piston, 8.6:1 Compression Ratio		1	1	1		1				1	1	1				1	1	1
- 2	639565	&† . Ring, Piston, Top Groove		1	1	1		1				1	1	1				1	1	1
- 3	639566	&† . Ring, Piston, Second Groove		1	1	1		1				1	1	1				1	1	1
- 5	639663	&† . Ring, Piston, Third Groove		1	1	1		1				1	1	1				1	1	1
- 6	627480	&† . Ring, Piston, Fourth Groove		1	1	1		1				1	1	1				1	1	1
- 7	539467	† . Pin and Plug Assembly, Piston		1	1	1		1				1	1	1				1	1	1

See Service Bulletin M75-18 for rings to be used with chrome cylinders.

FIG. & INDEX	PART NUMBER	DESCRIPTION	QUANTITY PER ASSEMBLY																	
			C	D	E	F	G	H	J	K	L	M	N	P	R	S	U	V		
13-	627738A6	Piston and Ring Assembly		6	6	6		6				6	6	6				6	6	6
- 1	627738	*† . Piston, 8.6:1 Compression Ratio		1	1	1		1				1	1	1				1	1	1
- 2	635095	**&† . Ring, Piston, Top Groove		1	1	1		1				1	1	1				1	1	1
- 2	628985	**&† . Ring, Piston, Top Groove		1	1	1		1				1	1	1				1	1	1
- 3	628754	&† . Ring, Piston, Second Groove		1	1	1		1				1	1	1				1	1	1
- 4	536939	&† . Ring, Piston, Third Groove		1	1	1		1				1	1	1				1	1	1
- 6	627480	&† . Ring, Piston, Fourth Groove		1	1	1		1				1	1	1				1	1	1
- 7	539467	† . Pin and Plug Assembly, Piston		1	1	1		1				1	1	1				1	1	1

See Service Bulletin M75-18 for rings to be used with chrome cylinders.

* Parts superseded and not replaceable by new parts except in complete sets.

Pistons identified by overall length. 627738 = 3.682 - 3.678 632932 = 3.79

631481 = 3.93 626992 = 3.54

See Service Bulletin M72-13 for information on reworking ring gap when used with normalized cylinders.

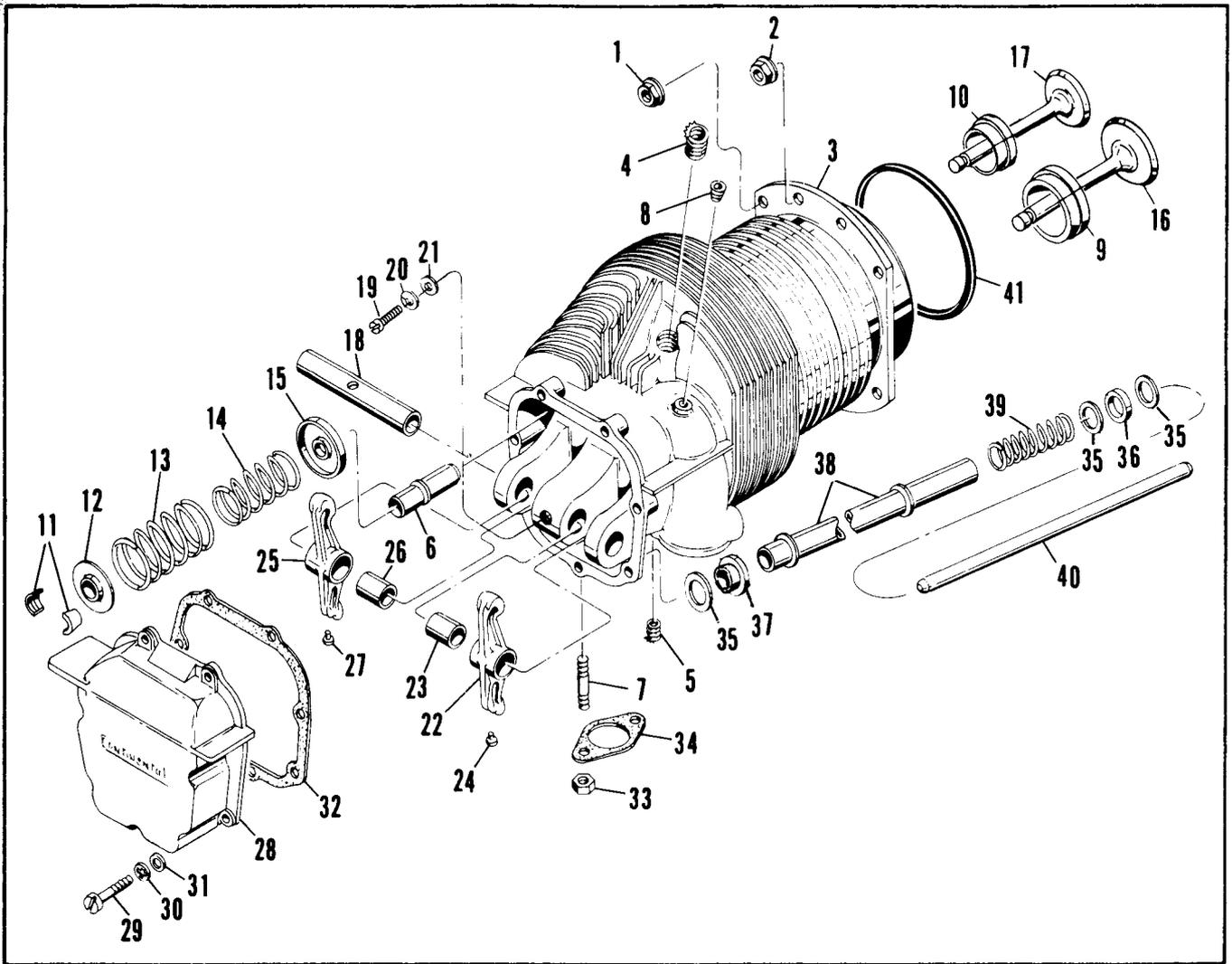

FIGURE 14. CYLINDER ASSEMBLY
MODELS O-470-A, E, J

FIG. & INDEX	PART NUMBER	DESCRIPTION	QUANTITY PER ASSEMBLY														
			A	B	E	G	J	K	L	M	P	R					
14-	No Number	Cylinder Assembly, Complete	ns		ns		ns										
		ATTACHING PARTS															
- 1	634505	Nut, Flanged			12		12										
- 2	531001	Nut, Flanged	36		36		36										
		* * * * *															
	539491A1	. Cylinder and Valve Assembly			6		6										
	628051A1	. Cylinder and Valve Assembly	6														
	539491	. . . Cylinder Assembly			1		1										
	539491CP	* . . . Cylinder Assembly			1		1										
	628051	. . . Cylinder Assembly	1														
	628051CP	* . . . Cylinder Assembly	1														
- 3	No Number	. . . Head and Barrel Assembly, Cyl.	ns		ns		ns										
- 4	520112	. . . Insert, Spark Plug, 18mm	2		2		2										
- 5	MS122121	. . . Insert, Intake Flange, 1/4-20	2		2		2										
- 6	515152	† . . . Guide, Valve	2		2		2										
- 7	401885	† . . . Stud, 5/16 X 1-9/32 Inch Long	2		2		2										

See Service Bulletin M72-13 regarding normalized cylinders.

* Optional Chrome Cylinders.

FIG. & INDEX	PART NUMBER	DESCRIPTION	QUANTITY PER ASSEMBLY																	
			A	B	E	G	J	K	L	M	P	R								
14-8	2024	. . . Plug, Countersunk Head Pipe, 1/8 Inch NPTF	1																	
- 8	629518-1	. . . Plug, Hollow Square Head Pipe, 1/8 Inch NPTF			1		1													
- 9	35966	† . . . Insert, Intake Valve Seat	1		1		1													
-10	35967	† . . . Insert, Exhaust Valve Seat	1		1		1													
-11	24802	. . Key, Valve Spring Retainer	4		4		4													
-12	35971	. . Retainer, Valve Spring, Outer	2		2		2													
-13	520105	. . Spring, Valve, Outer	2		2		2													
-14	520106	. . Spring, Valve, Inner	2		2		2													
-15	625393	. . Retainer, Valve Spring, Inner	2		2		2													
-16	40652	. . Valve, Intake	1		1		1													
-17	626540	. . Valve, Exhaust	1		1		1													
-18	625142	. Shaft, Valve Rocker	6		6		6													
-19	535666	. Screw, 5/16 X 25/32 Inch Long	6		6		6													
-20	MS35338-45	. Washer, Lock	6		6		6													
-21	2473	. Washer, Plain	6		6		6													
	A24814	. Rocker Assembly, Intake Valve	6		6		6													
-22	No Number	. . Rocker, Intake Valve	ns		ns		ns													
-23	530367	. . Bushing, Valve Rocker	1		1		1													
-24	21007	. . Screw, Round Head Drive	2		2		2													
	A24815	. Rocker Assembly, Exhaust Valve	6		6		6													
-25	No Number	. . Rocker, Exhaust Valve	ns		ns		ns													
-26	530367	. . Bushing, Valve Rocker	1		1		1													
-27	21007	. . Screw, Round Head Drive	1		1		1													
-28	532450-1	. Cover, Valve Rocker	6		6		6													
		ATTACHING PARTS																		
-29	535118	. Screw, Fillister Head	42		42		42													
-30	MS35338-44	. Washer, Lock	42		42		42													
-31	20522	. Washer, Plain	42		41		42													
		* * * *																		
-32	532451	& . Gasket, Valve Rocker Cover	6		6		6													
-33	22022	Nut, Hex	12		12		12													
-34	21493	& Gasket, Exhaust Flange	6		6		6													
-35	534609	Washer, Pushrod Housing	36		36		36													
-36	534610	& Packing, Pushrod Housing	12		12		12													
-37	536410	& Packing, Pushrod Housing	12		12		12													
-38	537296	Housing, Pushrod	12		12		12													
-39	626147	Spring, Pushrod Housing	12		12		12													
-40	538305	Pushrod	12		12		12													
-41	532200	& Packing Ring, Cylinder-to-Crankcase	6		6		6													

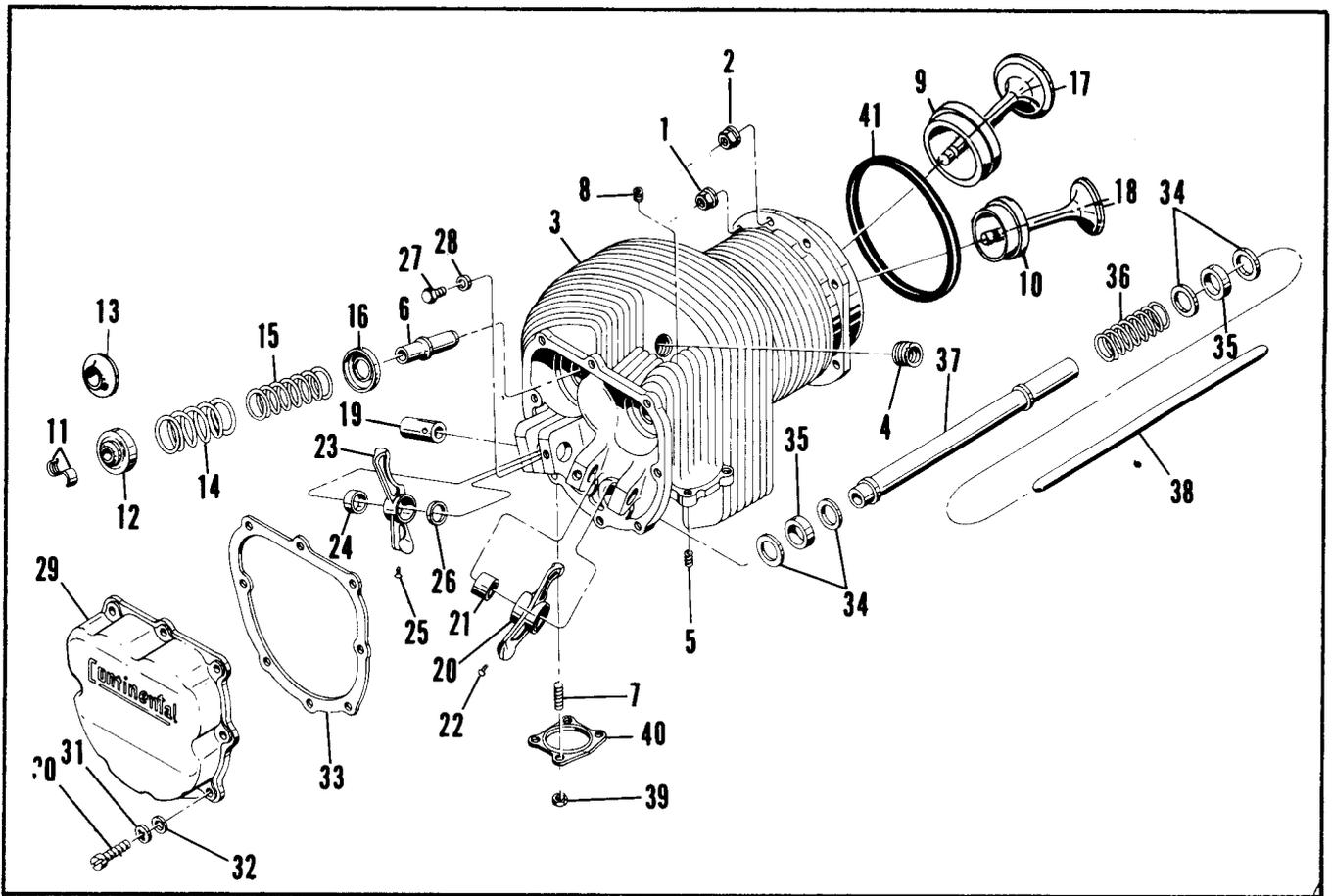

FIGURE 16. CYLINDER ASSEMBLY
MODELS O-470-B,G,K,L,M,P,R,S

FIG. & INDEX	PART NUMBER	DESCRIPTION	QUANTITY PER ASSEMBLY											
			A	B	E	G	J	K	L	M	P	R	S	
16-	No Number	Cylinder Assembly, Complete	ns		ns		ns	ns	ns	ns	ns	ns	ns	ns
		ATTACHING PARTS												
- 1	634505	Nut, Flanged	12		12		12	12	12	12	12	12	12	12
- 2	531001	Nut, Flanged	36		36		36	36	36	36	36	36	36	36
		* * * *												
	625859A1	. Cylinder and Valve Assembly				6			6	6				
	625859A3	. Cylinder and Valve Assembly					6	6				6		
	625859A7	. Cylinder and Valve Assembly											6	
	539492A1	. Cylinder and Valve Assembly												
	625859	. . Cylinder Assembly					1	1	1	1	1	1	1	
	625859CP	* . . Cylinder Assembly					1	1	1	1	1	1	1	
	539492	. . Cylinder Assembly												
- 3	No Number	. . . Head and Barrel Assembly, Cyl.	ns		ns		ns	ns	ns	ns	ns	ns	ns	
- 4	520112	. . . Insert, Spark Plug, 18mm	2		2		2	2	2	2	2	2		
- 4	520112-1	. . . Insert, Spark Plug, 18mm											2	
- 5	MS122121	. . . Insert, 1/4	4		4		4	4	4	4	4	4	4	
- 6	631496	† . . . Guide, Valve	2		2		2	2	2	2	2	2	2	
- 7	401804	† . . . Stud, 1/4 X 1-1/16 Inch Long	4											
- 7	401893	† . . . Stud, 1/4 X 1-1/4 Inch Long				4	4	4	4	4	4	4	4	
- 8	629518-1	. . . Plug, Countersunk Head Pipe, 1/8 Inch NPTF	1		1		1	1	1	1	1	1	1	

See Bulletin M72-13 regarding normalized cylinders.

* Optional Chrome Cylinders.

FIG. & INDEX	PART NUMBER	DESCRIPTION	QUANTITY PER ASSEMBLY																	
			A	B	E	G	J	K	L	M	P	R	S							
16- 9	35966	† . . . Insert, Intake Valve Seat	1																	
- 9	630591	† . . . Insert, Intake Valve Seat				1		1	1	1	1	1	1	1	1	1	1	1	1	1
-10	35967	† . . . Insert, Exhaust Valve Seat	1		1			1	1	1	1	1	1	1	1	1	1	1	1	1
-11	24802	. . . Key, Valve Spring Retainer	4		4			4	4	4	4	4	4	4	4	4	4	4	4	4
-12	629117	. . . Rotocap, Exhaust Valve Spring, Outer	1		1			1	1	1	1	1	1	1	1	1	1	1	1	1
-13	35971	. . . Retainer, Intake Valve Spring, Outer	1		1			1	1	1	1	1	1	1	1	1	1	1	1	1
-14	520105	. . . Spring, Valve, Outer	2		2			2	2	2	2	2	2	2	2	2	2	2	2	2
-15	637836	. . . Spring, Valve, Inner	2		2			2	2	2	2	2	2	2	2	2	2	2	2	2
-16	625393	. . . Retainer, Valve Spring, Inner	2		2			2	2	2	2	2	2	2	2	2	2	2	2	2
-17	539988	. . . Valve, Intake				1					1	1								
-17	625782	. . . Valve, Intake						1	1								1	1		
-17	625821	. . . Valve, Intake	1																	
-18	626540	. . . Valve, Exhaust	1		1			1	1	1	1	1	1	1	1	1	1	1	1	1
-19	539740	. Shaft, Valve Rocker	12		12			12	12	12	12	12	12	12	12	12	12	12	12	12
	539742	. Rocker Assembly, Intake Valve	6		6			6	6	6	6	6	6	6	6	6	6	6	6	6
-20	No Number	. . . Rocker, Intake Valve	ns		ns			ns	ns	ns	ns	ns	ns	ns	ns	ns	ns	ns	ns	ns
-21	639629	. . . Bushing, Valve Rocker	2		2			2	2	2	2	2	2	2	2	2	2	2	2	2
-22	21007	. . . Screw, Round Head Drive	1		1			1	1	1	1	1	1	1	1	1	1	1	1	1
	640944	. Rocker Assembly, Exhaust Valve	6		6			6	6	6	6	6	6	6	6	6	6	6	6	6
-23	No Number	. . . Rocker, Exhaust Valve	ns		ns			ns	ns	ns	ns	ns	ns	ns	ns	ns	ns	ns	ns	ns
-24	639629	. . . Bushing, Valve Rocker	2		2			2	2	2	2	2	2	2	2	2	2	2	2	2
-25	21007	. . . Screw, Round Head Drive	1		1			1	1	1	1	1	1	1	1	1	1	1	1	1
-26	639573	. Washer, Thrust	24		24			24	24	24	24	24	24	24	24	24	24	24	24	24
-27	537019	. Screw, Hex Head, 5/16 X 17/32 Inch Long	12		12			12	12	12	12	12	12	12	12	12	12	12	12	12
-28	2473	. Washer, Plain	12		12			12	12	12	12	12	12	12	12	12	12	12	12	12
-29	625615	. Cover, Valve Rocker	6					6	6	6	6	6	6	6	6	6	6	6	6	6
-29	625616	. Cover, Valve Rocker			6															
ATTACHING PARTS																				
-30	535118	. Screw, Fillister Head, 1/4 X 3/4 Inch Lg.	48		48			48	48	48	48	48	48	48	48	48	48	48	48	48
-31	MS35338-44	. Washer, Lock	48		48			48	48	48	48	48	48	48	48	48	48	48	48	48
-32	20522	. Washer, Plain	48		48			48	48	48	48	48	48	48	48	48	48	48	48	48
* * * *																				
-33	534857	& . Gasket, Valve Rocker Cover	6		6			6	6	6	6	6	6	6	6	6	6	6	6	6
-34	534609	Washer, Pushrod Housing	48		48			48	48	48	48	48	48	48	48	48	48	48	48	48
-35	534610	& Packing, Pushrod Housing	24		24			24	24	24	24	24	24	24	24	24	24	24	24	24
-36	626147	Spring, Pushrod Housing	12		12			12	12	12	12	12	12	12	12	12	12	12	12	12
-37	537296	Housing Pushrod	12		12			12	12	12	12	12	12	12	12	12	12	12	12	12
-38	538304	Pushrod	12		12			12	12	12	12	12	12	12	12	12	12	12	12	12
-39	21247	Nut, Hex	24		24			24	24	24	24	24	24	24	24	24	24	24	24	24
-39	536038	Nut, Hex																		24
-40	631544	& Gasket, Exhaust Flange	6		6			6	6	6	6	6	6	6	6	6	6	6	6	6
-41	532200	& Packing Ring, Cylinder-to-Crankcase	6		6			6	6	6	6	6	6	6	6	6	6	6	6	6

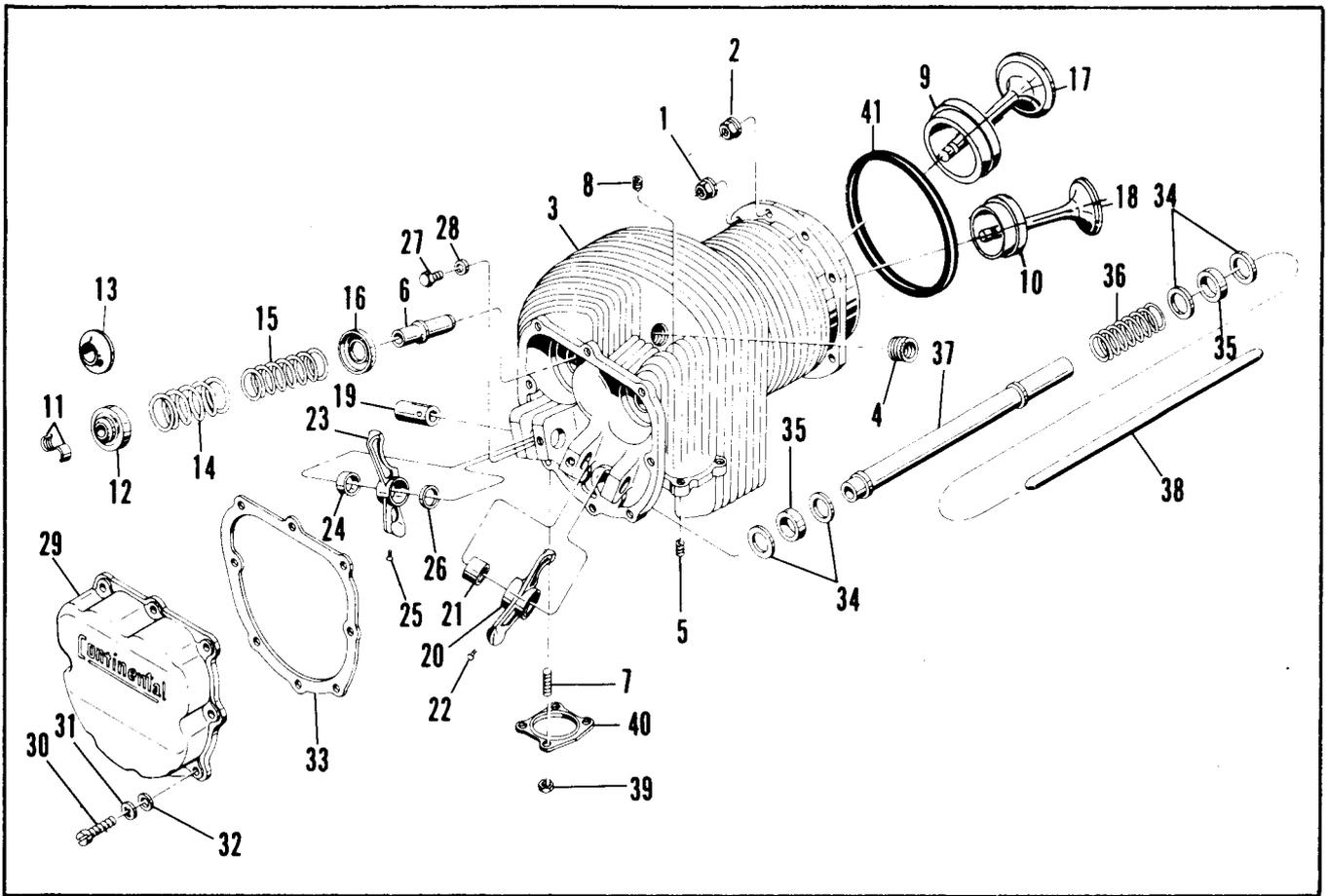

FIGURE 17. CYLINDER ASSEMBLY
 MODELS IO-470-C, D, E, F, G, H, L, M, N, P, R, S, U, V

FIG. & INDEX	PART NUMBER	DESCRIPTION	QUANTITY PER ASSEMBLY																	
			C	D	E	F	G	H	J	K	L	M	N	P	R	S	U	V		
17-	No Number	Cylinder Assembly, Complete	ns	ns	ns	ns	ns	ns					ns	ns	ns	ns	ns	ns	ns	ns
		ATTACHING PARTS																		
- 1	634505	Nut, Flanged	12	12	12	12	12	12					12	12	12	12	12	12	12	12
- 2	531001	Nut, Flanged	36	36	36	36	36	36					36	36	36	36	36	36	36	36
		* * * *																		
	626820A8	. Cylinder and Valve Assembly		6	6	6		6					6	6	6			6	6	6
	625859A1	. Cylinder and Valve Assembly	6					6								6	6			
	626820	* . . . Cylinder Assembly		1	1	1		1					1	1	1			1	1	1
	626820CP	** . . . Cylinder Assembly		1	1	1		1					1	1	1			1	1	1
	625859	. . . Cylinder Assembly	1					1								1	1			
	625859CP	** . . . Cylinder Assembly	1					1								1	1			
- 3	No Number	. . . Head and Barrel Assembly, Cyl.	ns	ns	ns	ns	ns	ns					ns	ns	ns	ns	ns	ns	ns	ns
- 4	520112-1	. . . Insert, Spark Plug, 18mm		2	2	2		2					2	2	2			2	2	2
- 4	520112	. . . Insert, Spark Plug, 18mm	2					2								2	2			
- 5	MS122121	. . . Insert, 1/4	4	4	4	4	4	4					4	4	4	4	4	4	4	4
- 6	631496	† . . . Guide, Valve	2	2	2	2	2	2					2	2	2	2	2	2	2	2
- 7	401893	† . . . Stud, 1/4 X 1-1/4 Inch Long	4	4	4	4	4	4					4	4	4	4	4	4	4	4
- 8	629518-1	. . . Plug, Countersunk Head Pipe, 1/8 Inch NPTF	1	1	1	1	1	1					1	1	1	1	1	1	1	1
- 9	630591	† . . . Insert, Intake Valve Seat	1	1	1	1	1	1					1	1	1	1	1	1	1	1
-10	35967	† . . . Insert, Exhaust Valve Seat	1	1	1	1	1	1					1	1	1	1	1	1	1	1

* Must have letter "H" stamped on top left side of rocker box flange if 0.015 oversize is intended. Replacement cylinders should be stamped in this manner. See Aircraft Service Bulletin M65-13.

See Service Bulletin M72-13 regarding normalized cylinders.

** Optional Chrome Cylinders.

FIG. & INDEX	PART NUMBER	DESCRIPTION	QUANTITY PER ASSEMBLY															
			C	D	E	F	G	H	J	K	L	M	N	P	R	S	U	V
17-11	24802	. . Key, Valve Spring Retainer	4	4	4	4	4	4			4	4	4	4	4	4	4	4
-12	629117	. . Rotocap, Exhaust Valve Spring, Outer	1	1	1	1	1	1			1	1	1	1	1	1	1	1
-13	35971	. . Retainer, Intake Valve Spring, Outer	1	1	1	1	1	1			1	1	1	1	1	1	1	1
-14	520105	. . Spring, Valve, Outer	2	2	2	2	2	2			2	2	2	2	2	2	2	2
-15	637836	. . Spring, Valve, Inner	2	2	2	2	2	2			2	2	2	2	2	2	2	2
-16	625393	. . Retainer, Valve Spring, Inner	2	2	2	2	2	2			2	2	2	2	2	2	2	2
-17	539988	. . Valve, Intake	1	1	1	1	1	1			1	1	1	1	1	1	1	1
-18	637781	. . Valve, Exhaust		1	1	1		1			1	1	1			1	1	1
-18	626540	. . Valve, Exhaust	1				1								1	1		
-19	539740	. Shaft, Valve Rocker	12	12	12	12	12	12			12	12	12	12	12	12	12	12
	539742	. Rocker Assembly, Intake Valve	6	6	6	6	6	6			6	6	6	6	6	6	6	6
-20	No Number	. . Rocker, Intake Valve	ns	ns	ns	ns	ns	ns			ns	ns	ns	ns	ns	ns	ns	ns
-21	536033	. . Bushing, Valve Rocker	2	2	2	2	2	2			2	2	2	2	2	2	2	2
-22	21007	. . Screw, Round Head Drive	1	1	1	1	1	1			1	1	1	1	1	1	1	1
	640944	. Rocker Assembly, Exhaust Valve	6	6	6	6	6	6			6	6	6	6	6	6	6	6
-23	No Number	. . Rocker, Exhaust Valve	ns	ns	ns	ns	ns	ns			ns	ns	ns	ns	ns	ns	ns	ns
-24	536033	. . Bushing, Valve Rocker	2	2	2	2	2	2			2	2	2	2	2	2	2	2
-25	21007	. . Screw, Round Head Drive	1	1	1	1	1	1			1	1	1	1	1	1	1	1
-26	534487	. Washer, Thrust	24	24	24	24	24	24			24	24	24	24	24	24	24	24
-27	537019	. Screw, Hex Head, 5/16 X 17/32 In. Lg.	12	12	12	12	12	12			12	12	12	12	12	12	12	12
-28	2473	. Washer, Plain	12	12	12	12	12	12			12	12	12	12	12	12	12	12
-29	625615	. Cover, Valve Rocker	6	6	6	6	6	6			6	6	6	6	6	6	6	6
		ATTACHING PARTS																
-30	535118	. Screw, Fillister Head, 1/4 X 3/4 In. Lg.	48	48	48	48	48	48			48	48	48	48	48	48	48	48
-31	MS35338-44	. Washer, Lock	48	48	48	48	48	48			48	48	48	48	48	48	48	48
-32	20522	. Washer, Plain	48	48	48	48	48	48			48	48	48	48	48	48	48	48
		* * * *																
-33	534857	& . Gasket, Valve Rocker Cover	6	6	6	6	6	6			6	6	6	6	6	6	6	6
-34	534609	Washer, Pushrod Housing	48	48	48	48	48	48			48	48	48	48	48	48	48	48
-35	534610	& Packing, Pushrod Housing	24	24	24	24	24	24			24	24	24	24	24	24	24	24
-36	626147	Spring, Pushrod Housing	12	12	12	12	12	12			12	12	12	12	12	12	12	12
-37	537296	Housing, Pushrod	12	12	12	12	12	12			12	12	12	12	12	12	12	12
-38	538304	Pushrod	12	12	12	12	12	12			12	12	12	12	12	12	12	12
-39	21247	Nut, Hex	24	24	24	24	24	24			24	24	24	24	24	24	24	24
-40	631544	& Gasket, Exhaust Flange	6	6	6	6	6	6			6	6	6	6	6	6	6	6
-41	532200	& Packing Ring, Cylinder-to-Crankcase	6	6	6	6	6	6			6	6	6	6	6	6	6	6

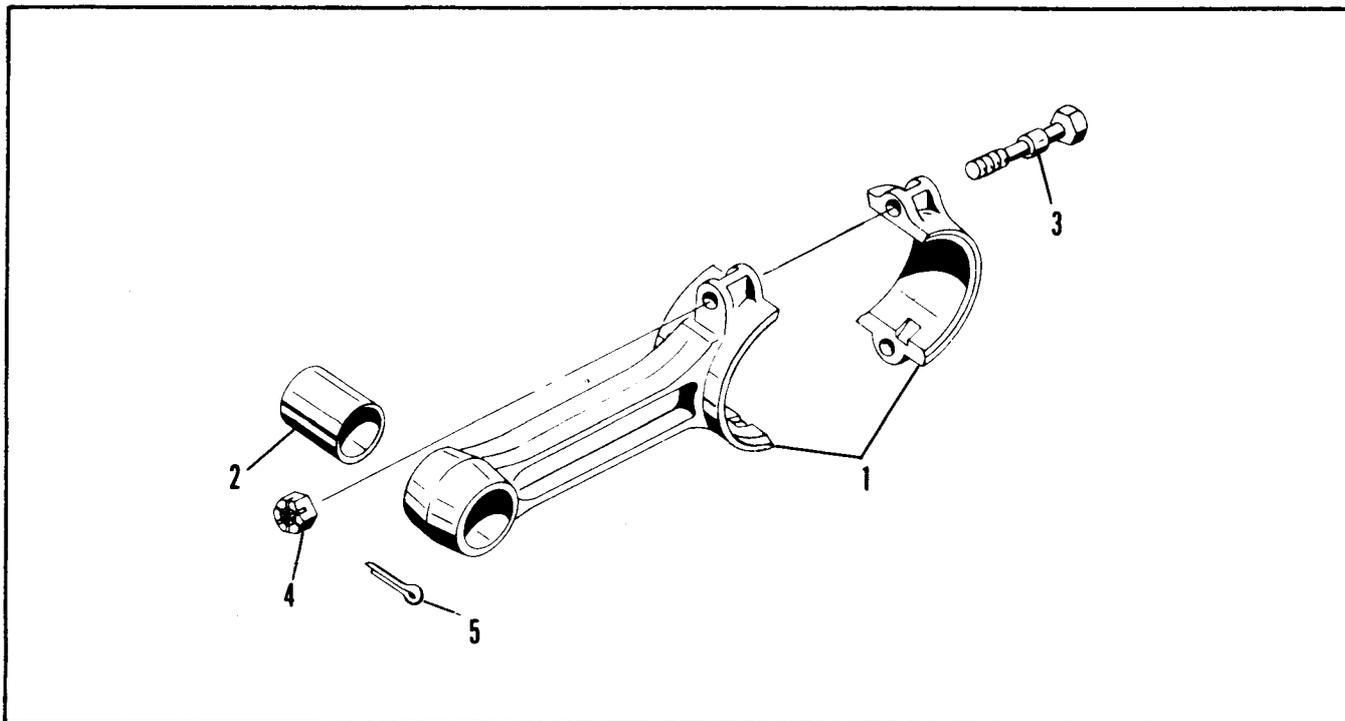

FIGURE 18. CONNECTING ROD ASSEMBLY

MODELS O-470- A,B,E,G,J,K,L,M,P,R,S

FIG. & INDEX	PART NUMBER	DESCRIPTION	QUANTITY PER ASSEMBLY											
			A	B	E	G	J	K	L	M	P	R	S	
18-	A36121	* Rod Assembly, Connecting	6	6	6	6	6	6	6	6	6	6	6	6
	628752	Rod Assembly, Connecting	6	6	6	6	6	6	6	6	6	6	6	6
- 1	No Number	. Rod & Cap, Connecting	ns	ns	ns	ns	ns	ns	ns	ns	ns	ns	ns	ns
- 2	530658	. Bushing, Piston Pin	1	1	1	1	1	1	1	1	1	1	1	1
- 3	35972	. Bolt	2	2	2	2	2	2	2	2	2	2	2	2
- 4	626140	. Nut, Slotted, Hex, 3/8	2	2	2	2	2	2	2	2	2	2	2	2
- 5	639292	. Pin, Cotter	2	2	2	2	2	2	2	2	2	2	2	2

MODELS IO-470-C, D, E, F, G, H, J, K, L, M, N, P, R, S, U, V

FIG. & INDEX	PART NUMBER	DESCRIPTION	QUANTITY PER ASSEMBLY															
			C	D	E	F	G	H	J	K	L	M	N	P	R	S	U	V
18-	A36121	* Rod Assembly, Connecting	6				6		6	6					6	6		
	628752	* Rod Assembly, Connecting	6	6	6	6		6	6	6	6	6	6			6	6	6
- 1	No Number	. Rod & Cap, Connecting	ns	ns	ns	ns	ns	ns	ns	ns	ns	ns	ns	ns	ns	ns	ns	ns
- 2	530658	. Bushing, Piston Pin	1	1	1	1	1	1	1	1	1	1	1	1	1	1	1	1
- 3	35972	. Bolt	2	2	2	2	2	2	2	2	2	2	2	2	2	2	2	2
- 4	626140	. Nut, Slotted, Hex, 3/8	2	2	2	2	2	2	2	2	2	2	2	2	2	2	2	2
- 5	639292	. Pin, Cotter	2	2	2	2	2	2	2	2	2	2	2	2	2	2	2	2

* Engines not having the engine serial number prefixed by "CS" will use A36121 rods.
For further information see Aircraft Service Bulletin M62-8, Supplement No. 1.

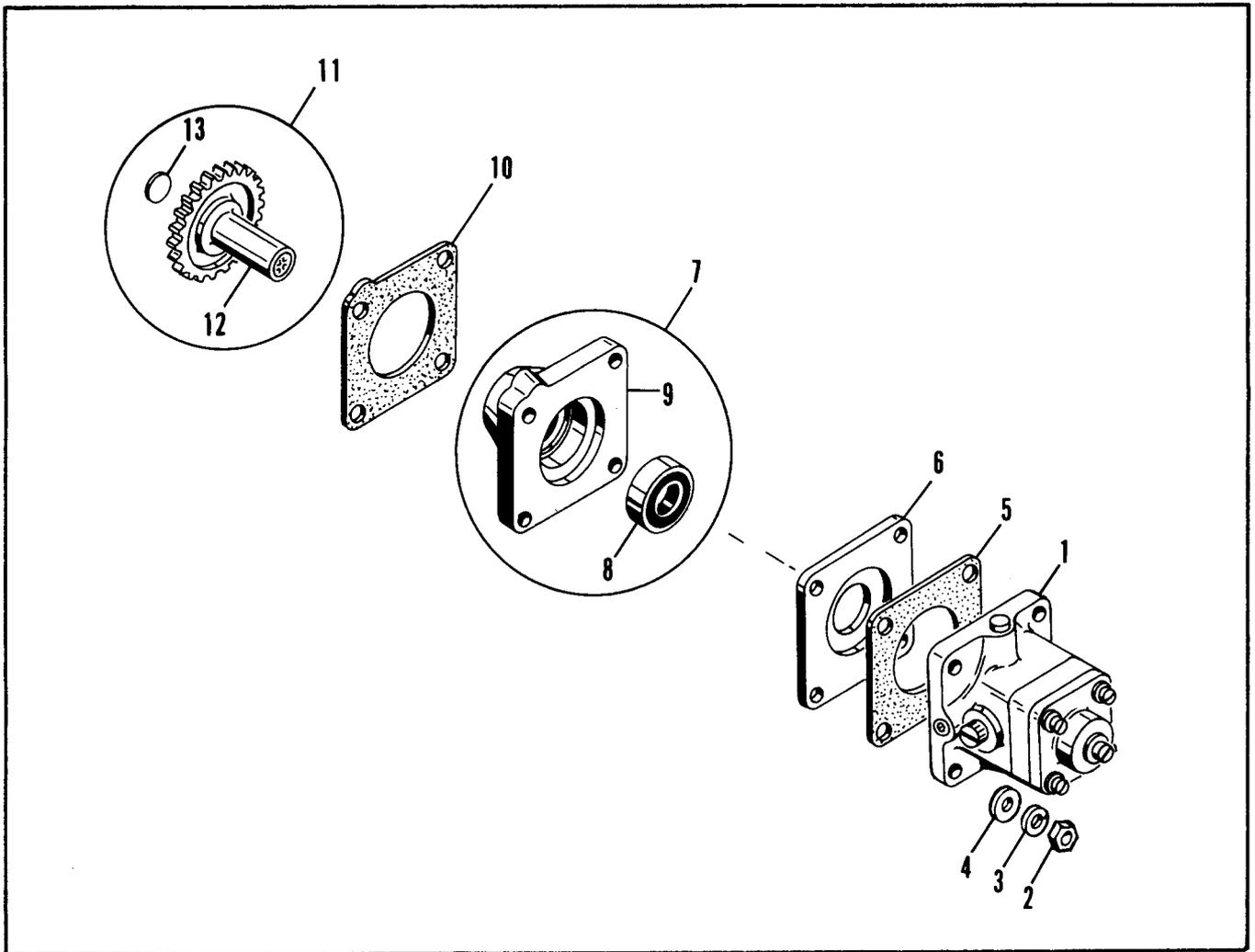

FIGURE 19. FUEL PUMP, ADAPTER AND DRIVE GEAR
MODELS O-470-B, E, G, M, P

FIG. & INDEX	PART NUMBER	DESCRIPTION	QUANTITY PER ASSEMBLY												
			A	B	E	G	J	K	L	M	P	R			
19- 1	626845	Pump Assembly, Fuel (Romec No. RG15980)		1	1	1						1	1		
		ATTACHING PARTS													
- 2	2439	Nut, Plain Hex		4	4	4						4	4		
- 3	MS35338-45	Washer, Lock		4	4	4						4	4		
- 4	2473	Washer, Plain		4	4	4						4	4		
		* * * *													
- 5	MS9137-01	Gasket, Fuel Pump		2	2	2						2	2		
- 6	537682	Insulator, Fuel Pump		1	1	1						1	1		
- 7	627518	Adapter Assembly, Fuel Pump		1		1								1	
- 7	534987	Adapter Assembly, Fuel Pump				1						1			
- 8	534956	& . Oil Seal		1	1	1						1	1		
- 9	No Number	. Adapter		ns	ns	ns						ns	ns		
-10	534941	& Gasket, Fuel Pump Adapter		1	1	1						1	1		
-11	534995	Gear Assembly, Fuel Pump Drive		1	1	1						1	1		
-12	No Number	. Gear		ns	ns	ns						ns	ns		
-13	539634	. Plug		1	1	1						1	1		

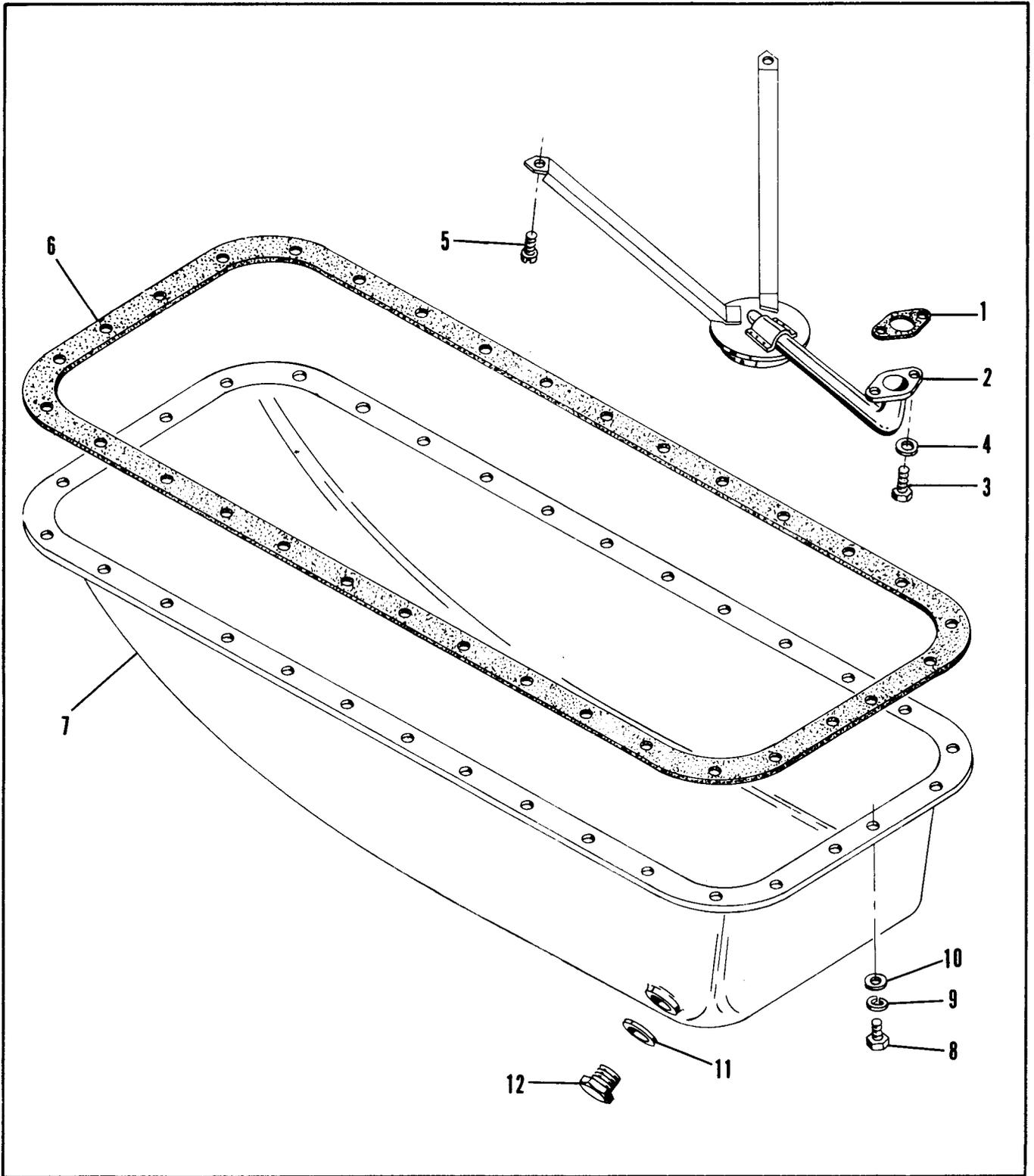

FIGURE 20. OIL SUMP

MODELS O-470-A,B,E,J,K,L,M,R,S

FIG. & INDEX	PART NUMBER	DESCRIPTION	QUANTITY PER ASSEMBLY												
			A	B	E	G	J	K	L	M	P	R	S		
20- 1	534940	& Gasket, Suction Tube	1	1	1			1	1	1	1			1	1
- 2	625207	Tube Assembly, Oil Pump Suction	1	1	1			1	1	1	1			1	1
ATTACHING PARTS															
- 3	AN74A4	Bolt, Drilled Head	2	2	2			2	2	2	2			2	2
- 4	20522	Washer, Plain	2	2	2			2	2	2	2			2	4
- 5	AN74A3	Bolt, Drilled Head	2	2	2			2	2	2	2			2	2
* * * *															
- 6	534743	& Gasket, Oil Sump	1	1	1			1	1	1	1			1	1
- 7	537650	Sump Assembly, Oil	1	1	1			1	1		1			1	
- 7	539937	Sump Assembly, Oil								1				1	1
ATTACHING PARTS															
- 8	530346	Screw, Hex Head, 5/16 X 7/8 Inch Long	28	26	28			28	28	28	26			28	28
- 9	13XX202B	Washer, Lock, 5/16 Inch	24	24	28			28	28	28	26			28	28
-10	2473	Washer, Plain	24	26	28			28	28	28	26			28	28
* * * *															
-11	AN900-10	& Gasket, Annular	2	2	2			2	2	2	2			2	2
-12	532432	Plug, Oil Drain, 5/8	2	2	2			2	2	2	2			2	2

MODELS IO-470-D, E, F, G, L, M, P, R, S, U, V

FIG. & INDEX	PART NUMBER	DESCRIPTION	QUANTITY PER ASSEMBLY															
			C	D	E	F	G	H	J	K	L	M	N	P	R	S	U	V
20- 1	534940	& Gasket, Suction Tube	1	1	1	1					1	1		1	1	1	1	1
- 2	625207	Tube Assembly, Oil Pump Suction	1	1	1	1					1	1		1	1	1	1	1
ATTACHING PARTS																		
- 3	AN74A4	Bolt, Drilled Head	2	2	2	2					2	2		2	2	2	2	2
- 4	20522	Washer, Plain	2	2	2	2					2	2		2	2	2	2	2
- 5	AN74A3	Bolt, Drilled Head	2	2	2	2					2	2		2	2	2	2	2
* * * *																		
- 6	534743	& Gasket, Oil Sump	1	1	1	1					1	1		1	1	1	1	1
- 7	537650	Sump Assembly, Oil	1	1	1	1					1			1	1		1	1
- 7	628698	Sump Assembly, Oil										1						
- 7	633412	Sump Assembly, Oil															1	
ATTACHING PARTS																		
- 8	530346	Screw, Hex Head, 5/16 X 7/8 Inch Long	26	26	28	26					28	28		28	26	26	30	30
- 9	13XX202B	Washer, Lock, 5/16 Inch	26	26	28	26					28	28		28	26	26	30	30
-10	2473	Washer, Plain	26	26	28	26					28	28		28	26	26	30	30
* * * *																		
-11	AN900-10	& Gasket, Annular	2	2	2	2					2			2	2	2	2	2
-11	AN900-12	& Gasket, Annular											2					
-12	20274	Plug, Oil Drain, 3/4											2					
-12	532432	Plug, Oil Drain, 5/8	2	2	2	2					2			2	2	1	2	2

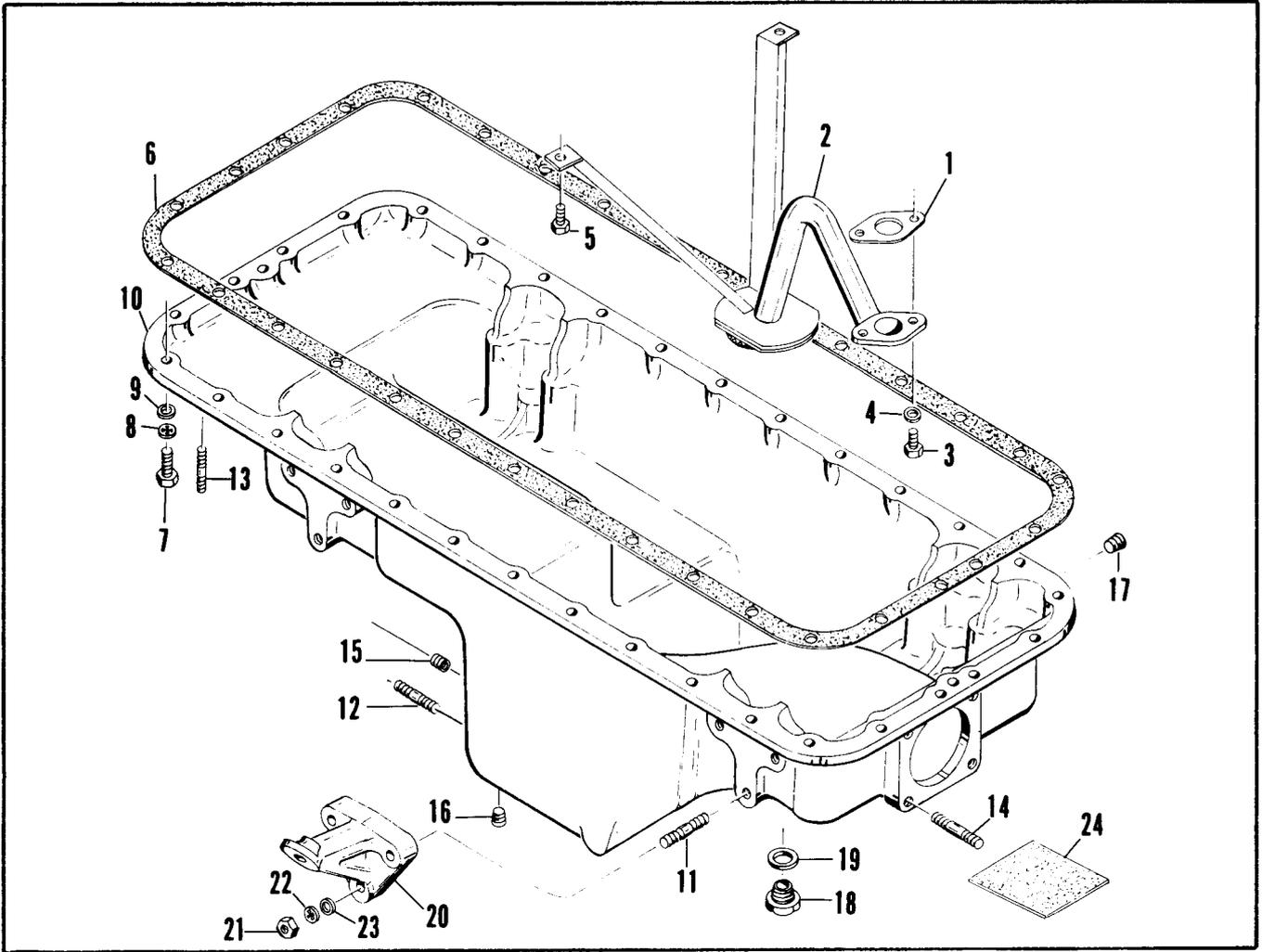

FIGURE 21. OIL SUMP

MODELS O-470-G, P

FIG. & INDEX	PART NUMBER	DESCRIPTION	QUANTITY PER ASSEMBLY												
			A	B	E	G	J	K	L	M	P	R			
21- 1	534940	& Gasket, Suction Tube					1							1	
- 2	538937	Tube Assembly, Oil Pump Suction					1							1	
		ATTACHING PARTS													
- 3	AN74A4	Bolt					2							2	
- 4	20522	Washer, Plain					2							2	
- 5	AN74A3	Bolt					2							2	
		* * * *													
- 6	534743	& Gasket, Oil Sump					1							1	
	538814A1	Sump Studding Assembly					1							1	
		ATTACHING PARTS													
- 7	537750	Bolt, 5/16 X 1-1/8 Inch Long					32							32	
- 8	13XX202B	Washer, Lock					32							32	
- 9	2473	Washer, Plain					32								
- 9	22533	Washer, Plain												32	
		* * * *													
-10	No Number	. Sump, Oil					ns							ns	
-11	401860	† . Stud, 3/8 X 1-9/16 Inch Long					12							12	
-12	401885	† . Stud, 5/16 X 1-5/16 Inch Long					2							2	

MODELS O-470-G,P

FIG. & INDEX	PART NUMBER	DESCRIPTION	QUANTITY PER ASSEMBLY												
			A	B	E	G	J	K	L	M	P	R			
21-13	401804	† . Stud, 1/4 X 1-1/16 Inch Long					4							4	
-14	401885	† . Stud, 5/16 X 1-5/16 Inch Long					4							4	
-15	MS122122	. Insert, 5/16					2							2	
-16	2024	. Plug, Pipe, 1/8					1							1	
-17	401753	. Plug, Pipe, 1/4					1							1	
-18	2265	. Plug, Oil Drain, 5/8					1							1	
-19	AN900-10	& . Gasket, Annular					1							1	
-20	625383	Bracket, Engine Mount												4	
-20	626089	Bracket, Engine Mount					4								
ATTACHING PARTS															
-21	2441	Nut, Hex					12							12	
-22	MS35338-46	Washer, Lock					12							12	
-23	2474	Washer, Plain					12							12	
* * * *															

MODELS IO-470-C, H, J, K, N

FIG. & INDEX	PART NUMBER	DESCRIPTION	QUANTITY PER ASSEMBLY																	
			C	D	E	F	G	H	J	K	L	M	N	P	R	S	U	V		
21- 1	534940	& Gasket, Suction Tube	1						1	1	1					1				
- 2	538937	Tube Assembly, Oil Pump Suction	1						1	1										
- 2	628409	Tube Assembly, Oil Pump Suction									1					1				
ATTACHING PARTS																				
- 3	AN74A4	Bolt	2						2	2	2					2				
- 4	20522	Washer, Plain	2						2	2	2					2				
- 5	AN74A3	Bolt	2						2	2	2					2				
* * * *																				
- 6	534743	& Gasket, Oil Sump	1						1	1	1					1				
	538814A1	Sump Studding Assembly	1						1	1										
	628372A1	Sump Studding Assembly									1					1				
ATTACHING PARTS																				
- 7	537750	Bolt, 5/16 X 1-1/8 Inch Long	32						32	32	30					32				
- 8	13XX202B	Washer, Lock	32						32	32	30					32				
- 9	AN960-516L	Washer, Plain	32						32	32	30					32				
* * * *																				
-10	No Number	. Sump, Oil	ns						ns	ns	ns					ns				
-11	401860	† . Stud, 3/8 X 1-9/16 Inch Long	12						12	12	12					12				
-12	401885	† . Stud, 5/16 X 1-5/16 Inch Long	2						2	2						2				
-13	401804	† . Stud, 1/4 X 1-1/16 Inch Long	4						4	4										
-13	401806	† . Stud, 1/4 X 1-1/4 Inch Long									4					4				
-14	401885	† . Stud, 5/16 X 1-5/16 Inch Long	4						4	4										
-15	MS122122	. Insert, 5/16	2						2	2										
-16	2024	. Plug, Pipe, 1/8	1						1	1										
-17	401753	. Plug, Pipe, 1/4	1						1	1	1									
-18	2265	. Plug, Oil Drain, 5/8	1						1	1	1					1				
-19	AN900-10	& . Gasket, Annular	1						1	1	1					1				
-20	625383	Bracket, Engine Mount							4											
-20	626089	Bracket, Engine Mount	4								4	4				4				
ARRACHING PARTS																				
-21	2441	Nut, Hex	12						12	12	12					12				
-22	MS35338-46	Washer, Lock	12						12	12	12					12				
-23	2474	Washer, Plain	12						12	12	12					12				
* * * *																				
-24	534625	Felt, 3-1/16 X 4-1/16 Inch														1				

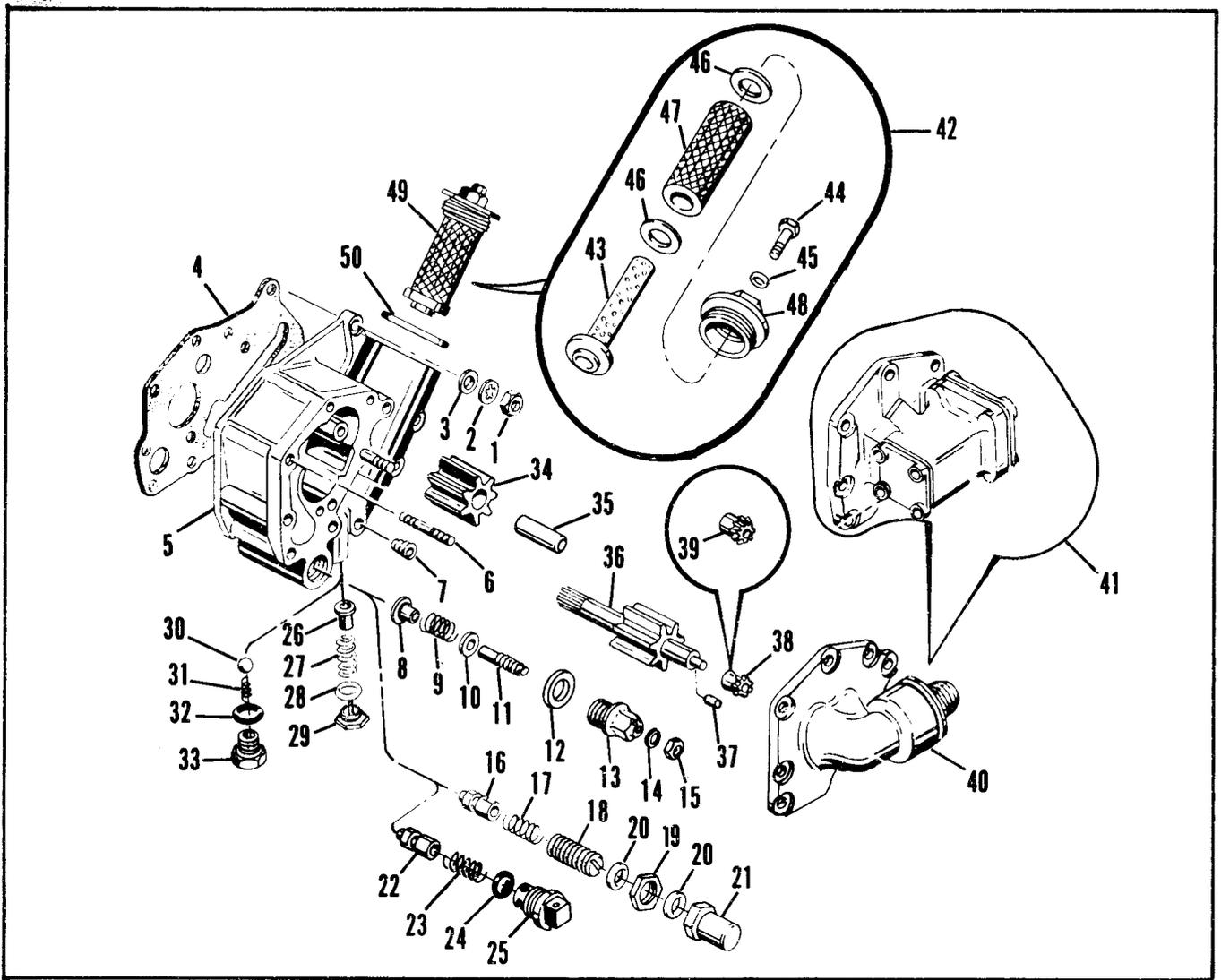

FIGURE 22. OIL PUMP ASSEMBLY
MODELS O-470-A,B,E,G,J,K,L,M,P,R,S

FIG. & INDEX	PART NUMBER	DESCRIPTION	QUANTITY PER ASSEMBLY																	
			A	B	E	G	J	K	L	M	P	R	S							
22-	632563A10	Housing Assembly, Oil Pump, Complete	1																	
	632563A2	Housing Assembly, Oil Pump, Complete		1	1							1								
	632563A4	Housing Assembly, Oil Pump, Complete						1	1	1										
	632563A7	Housing Assembly, Oil Pump, Complete																1	1	
	632563A5	Housing Assembly, Oil Pump, Complete					1							1						
ATTACHING PARTS																				
- 1	2437	Nut, Plain, Hex	11	11	11	11	11	11	11	11	11	11	11	11	11	11	11	11	11	11
- 2	MS35338-44	Washer, Lock	11	11	11	11	11	11	11	11	11	11	11	11	11	11	11	11	11	11
- 3	20522	Washer, Plain	11	11	11	11	11	11	11	11	11	11	11	11	11	11	11	11	11	11
* * * * *																				
- 4	538185	& Gasket, Pump Housing	1	1	1	1	1	1	1	1	1	1	1	1	1	1	1	1	1	1
	632563	* . Housing and Shaft Assy, Oil Pump	1	1	1	1	1	1	1	1	1	1	1	1	1	1	1	1	1	1
	No Number	. . Housing, Oil Pump	ns	ns	ns	ns	ns	ns	ns	ns	ns	ns	ns	ns	ns	ns	ns	ns	ns	ns
- 5	401963	† . . Stud, 1/4 X 1 Inch Long	2	2	2	2	2	2	2	2	2	2	2	2	2	2	2	2	2	2
- 6	AN932-2	. . Plug, Pipe, 1/8 Inch NPT	1	1	1	1	1	1	1	1	1	1	1	1	1	1	1	1	1	1
- 7	631618	. Plunger, Oil Pressure Relief Valve	1	1	1	1	1	1	1	1	1	1	1	1	1	1	1	1	1	1
- 8	634150	. Spring, Oil Pressure Relief Valve	1	1	1	1	1	1	1	1	1	1	1	1	1	1	1	1	1	1
- 9	632478	. Spring, Oil Pressure Relief Valve	1																	

FIG. & INDEX	PART NUMBER	DESCRIPTION	QUANTITY PER ASSEMBLY											
			A	B	E	G	J	K	L	M	P	R	S	
22-10	631653	. Washer, Special, Oil Pressure Relief Valve	1	1	1	1	1	1	1	1	1	1	1	1
-11	632761	. Screw, Adjusting, Oil Pressure Relief Valve	1	1	1	1	1	1	1	1	1	1	1	1
-12	AN900-18	. Gasket, Annular	1	1	1	1	1	1	1	1	1	1	1	1
-13	640919	. Housing, Oil Pressure Relief Valve	1	1	1	1	1	1	1	1	1	1	1	1
-14	X1473	. Gasket, Copper	1	1	1	1	1	1	1	1	1	1	1	1
-15	632762	. Nut, Lock	1	1	1	1	1	1	1	1	1	1	1	1
-16	627494	** . Plunger, Oil Pressure Relief Valve					1					1		
-17	627495	** . Spring, Oil Pressure Relief Valve					1					1		
-18	627651	** . Screw, Adjusting					1					1		
-19	627652	** . Nut, Adjusting Screw					1					1		
-20	AN900-14	&** . Gasket, Annular					2					2		
-21	627650	** . Cap, Oil Pressure Relief Valve					1					1		
-22	537229	** . Plunger, Oil Pressure Relief Valve	1											
-22	538580	** . Plunger, Oil Pressure Relief Valve		1	1		1	1	1	1		1		
-23	537589	** . Spring, Oil Pressure Relief Valve	1											
-23	538735	** . Spring, Oil Pressure Relief Valve		1	1		1	1	1	1		1		
-24	AN900-10	&** . Gasket, Annular	1											
-24	AN900-14	&** . Gasket, Annular		1	1		1	1	1	1		1		
-25	537235	. Cap, Oil Pressure Relief Valve	1											
-25	538736	** . Cap, Oil Pressure Relief Valve		1	1		1	1	1	1		1		
-26	631638	. Valve, By-Pass	1	1	1	1	1	1	1	1	1	1	1	1
-27	631478	. Spring, By-Pass Valve	1	1	1	1	1	1	1	1	1	1	1	1
-28	AN900-14	& . Gasket, Annular	1	1	1	1	1	1	1	1	1	1	1	1
-29	631995	. Pin and Plug Assembly	1	1	1	1	1	1	1	1	1	1	1	1
-30	2849	** . Ball, Filter By-Pass		1	1	1	1	1	1	1	1	1	1	1
-31	2848	** . Spring, Filter By-Pass		1	1	1	1	1	1	1	1	1	1	1
-32	AN900-10	&** . Gasket, Annular		1	1	1	1	1	1	1	1	1	1	1
-33	532432	** . Plug, Filter By-Pass		1	1	1	1	1	1	1	1	1	1	1
	539525	. Gear & Bushing Assembly, Oil Pump	1	1	1	1	1	1	1	1	1	1	1	1
-34	No Number	. Gear, Oil Pump Driven	ns	ns	ns	ns	ns	ns	ns	ns	ns	ns	ns	ns
-35	539523	. Bushing, Oil Pump Gear	2	2	2	2	2	2	2	2	2	2	2	2
	538516	. Gear Assembly, Oil Pump and Tachometer Drive		1	1						1			
	538609	. Gear Assembly, Oil Pump and Tachometer Drive	1			1	1	1	1		1	1	1	1
-36	No Number	. Gear, Oil Pump Drive	ns	ns	ns	ns	ns	ns	ns	ns	ns	ns	ns	ns
-37	535634	. Dowel	1	1	1	1	1	1	1	1	1	1	1	1
-38	535008	. Gear, Bevel, Tachometer Drive	1			1	2	2	2		1	1	1	1
-39	535900	. Gear, Bevel, Tachometer Drive		1	1						1			
-40	625886	. Cover, Oil Pump, Mechanical Tach (For detail parts see Figure 23)		1	1						1		1	1
-41	538789	. Cover, Oil Pump, Electric Tach (For detail parts see Figure 23)	1			1	1	1	1		1		1	
-42	538727	. Filter, Oil	1	1	1		1	1	1	1		1	1	
-43	Q9T116-218	. Tube Assembly, Perforated	1	1	1		1	1	1	1		1	1	
-44	MS20073-04-10	. Bolt, Drilled Hex Head	1	1	1		1	1	1	1		1	1	
-45	Q9S552-06	. Washer, Annular, 1/4 Inch	1	1	1		1	1	1	1		1	1	
-46	535933	. Gasket, Felt, 5/8 Inch ID	2	2	2		2	2	2	2		2		
-47	Q9T116-07	. Element, Filter	1	1	1		1	1	1	1		1	1	
-48	628129	. Body Casting, Filter	1	1	1		1	1	1	1		1	1	
-49	534862	. Screen Assembly, Oil					1					1		
-50	AN900-28	& . Gasket, Annular	1	1	1	1	1	1	1	1	1	1	1	1

* If replacing old style pump body, service with 632563A11.

** Existence of these parts indicates early style pump. If pump is serviceable, these parts must be used to replace worn parts.

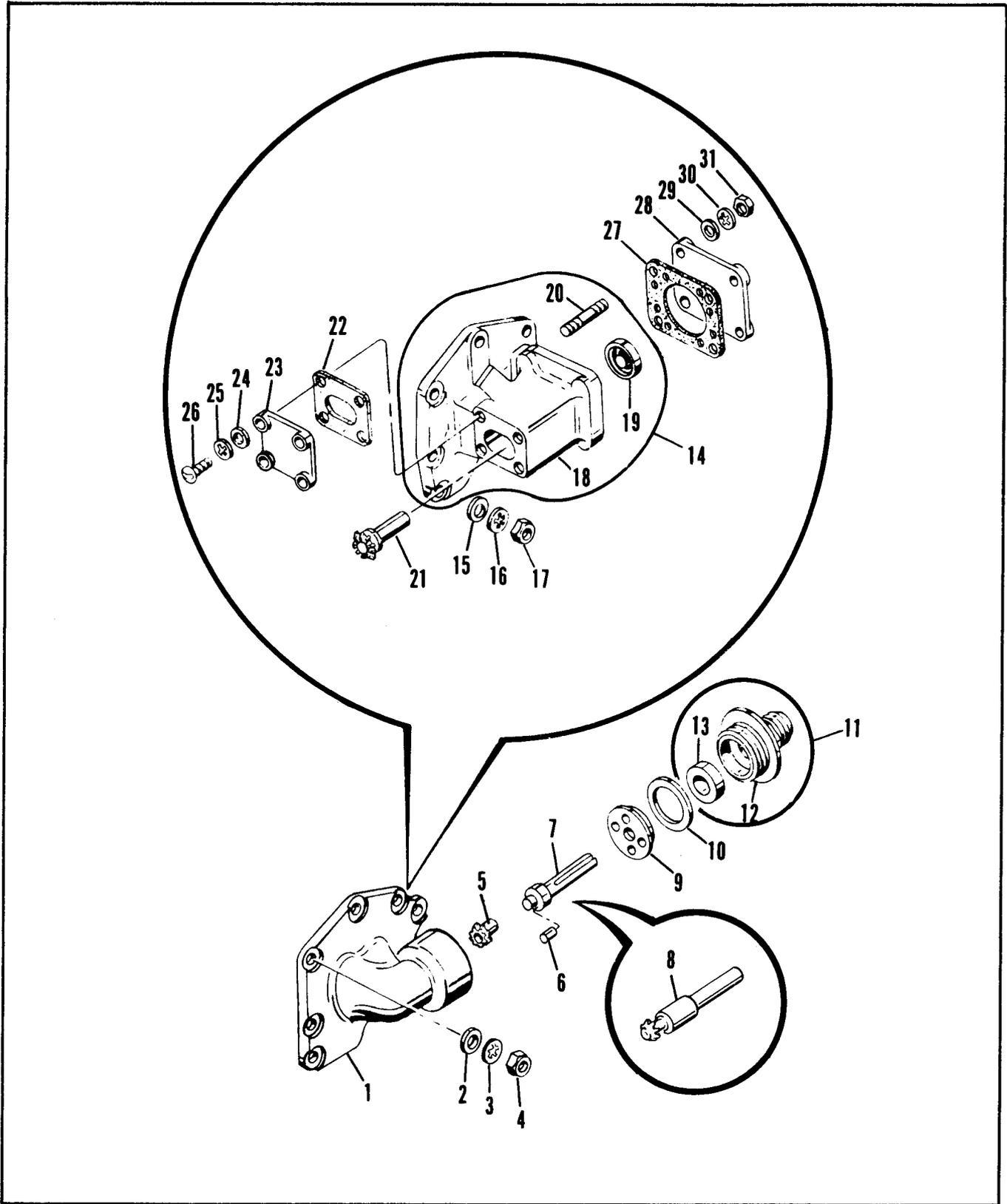

FIGURE 23. OIL PUMP COVER AND TACHOMETER DRIVE
 MODELS O-470-A, B, E, G, J, K, L, M, P, R, S

FIG. & INDEX	PART NUMBER	DESCRIPTION	QUANTITY PER ASSEMBLY											
			A	B	E	G	J	K	L	M	P	R	S	
23- 1	625886	Cover, Oil Pump	Rf			Rf	Rf	Rf	Rf			Rf	Rf	Rf
		ATTACHING PARTS												
- 2	20522	Washer, Plain	2			2	2	2	2			2	2	2
- 3	MS35338-44	Washer, Lock	2			2	2	2	2			2	2	2
- 4	2437	Nut, Plain, Hex	2			2	2	2	2			2	2	2
		* * * *												
- 5	535008	Gear, Bevel, Tach Drive	Rf			Rf	Rf	Rf				Rf	Rf	Rf
	535010	Shaft Assembly, Tach Drive	1			1	1	1						
- 6	535634	. Dowel	1			1	1	1						
- 7	No Number	. Shaft	ns			ns	ns	ns						
- 8	631650	Shaft and Gear Assembly	1			1						1	1	1
- 9	534873	Washer, Thrust	1			1	1	1				1		
-10	AN900-15	& Gasket, Annular				1	1	1						
-10	632085	& Gasket, Annular	1			1						1	1	
-11	21208A1	Housing Assembly, Tach Drive	1			1	1	1	1			1	1	1
-12	No Number	. Housing	ns			ns	ns	ns	ns			ns	ns	ns
-13	640087	& . Seal, Oil	1			1	1	1	1			1	1	1
-14	538789	Cover Assembly, Oil Pump		Rf	Rf							Rf		
		ATTACHING PARTS												
-15	20522	Washer, Plain		1	1							1		1
-15	25164	Washer, Special		2	2							2		2
-16	MS35338-44	Washer, Lock		2	2							2		2
-17	2437	Nut, Plain, Hex		2	2							2		2
		* * * *												
-18	No Number	. Cover	ns	ns								ns		ns
-19	531378	& . Seal, Oil	1	1								1		1
-20	401963	† . Stud, 1/4 X 1-1/4 Inch Long	1	1								1		1
-21	535908	Gear, Bevel, Tach Drive	1	1								1		1
-22	535885	& Gasket	1	1								1		1
-23	535887	Cover, Tach Gear Box	1	1								1		1
		ATTACHING PARTS												
-24	2471	Washer, Plain	4	4								4		4
-25	22910	Washer, Lock	4	4								4		4
-26	20655	Screw	4	4								4		4
		* * * *												
-27	MS9134-01	& Gasket	1	1								1		1
-28	633068	Cover, Tach Drive Pad	1	1								1		1
		ATTACHING PARTS												
-29	2472	Washer, Plain	4	4								4		4
-30	MS35338-44	Washer, Lock	4	4								4		4
-31	2437	Nut, Plain, Hex	4	4								4		4
		* * * *												

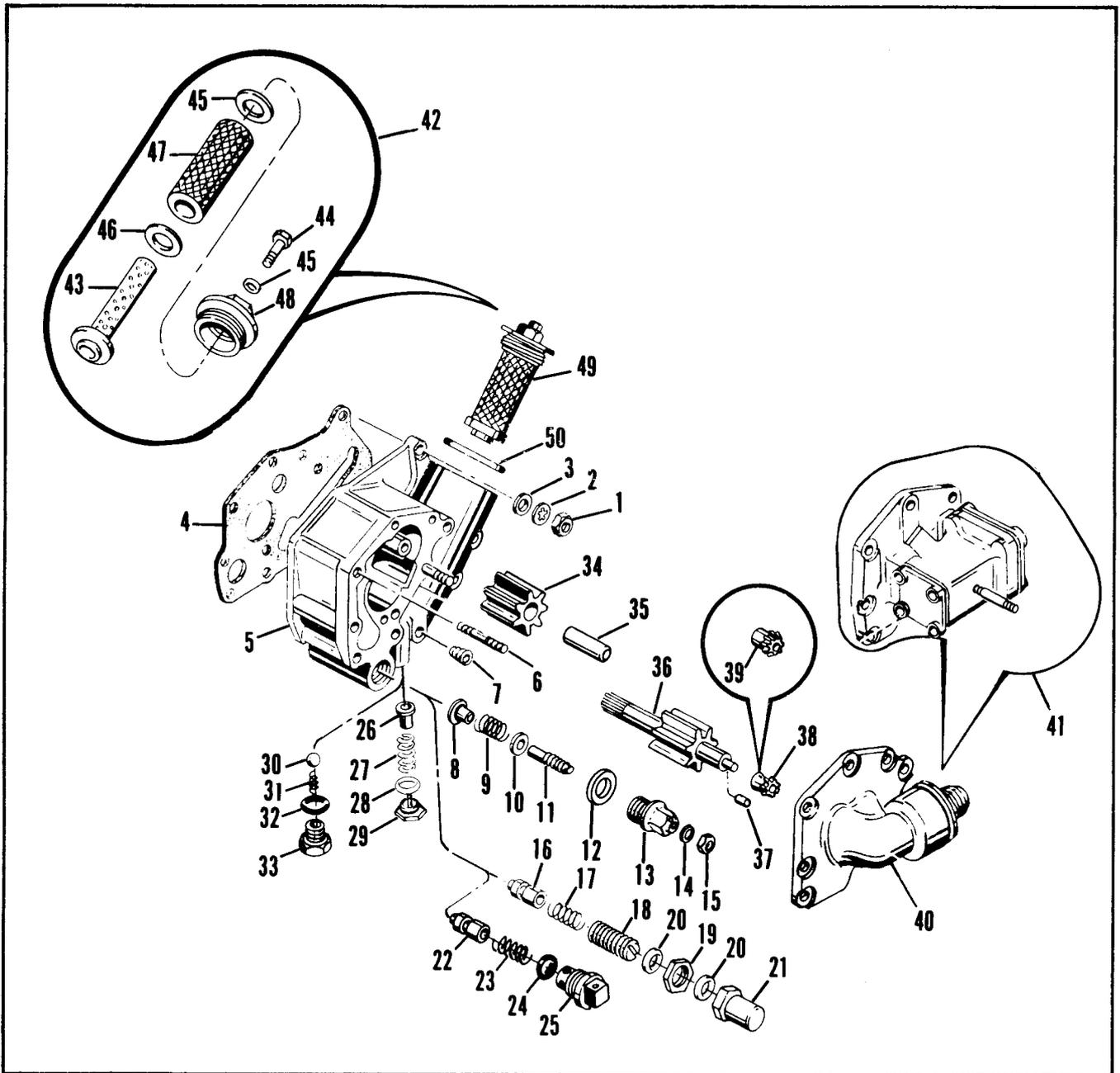

FIGURE 24. OIL PUMP ASSEMBLY
 MODELS IO-470-C, D, E, F, G, H, J, K, L, M, N, P, R, S, U, V

FIG. & INDEX	PART NUMBER	DESCRIPTION	QUANTITY PER ASSEMBLY															
			C	D	E	F	G	H	J	K	L	M	N	P	R	S	U	V
24-	632563A7	Housing Assembly, Oil Pump, Complete			1	1											1	
	632563A5	Housing Assembly, Oil Pump, Complete	1				1	1	1	1				1		1		
	632563A6	Housing Assembly, Oil Pump, Complete		1													1	1
	632563A8	Housing Assembly, Oil Pump, Complete											1					
	632563A9	Housing Assembly, Oil Pump, Complete										1						
ATTACHING PARTS																		
- 1	2437	Nut, Plain, Hex	11	11	11	11	11	11	11	11	11	11	11	11	11	11	11	11
- 2	MS35338-44	Washer, Lock	11	11	11	11	11	11	11	11	11	11	11	11	11	11	11	11
- 3	20522	Washer, Plain	11	11	11	11	11	11	11	11	11	11	11	11	11	11	11	11
* * * *																		
- 4	538185	& Gasket, Pump Housing	1	1	1	1	1	1	1	1	1	1	1	1	1	1	1	1

FIG. & INDEX	PART NUMBER	DESCRIPTION	QUANTITY PER ASSEMBLY																
			C	D	E	F	G	H	J	K	L	M	N	P	R	S	U	V	
24-	632563	* . Housing and Shaft Assembly, Oil Pump	1	1	1	1	1	1	1	1	1	1	1	1	1	1	1	1	
- 5	No Number	. . Housing, Oil Pump and Filter	ns	ns	ns	ns	ns	ns	ns	ns	ns	ns	ns	ns	ns	ns	ns		
- 6	401963	† . Stud, 1/4 X 1 Inch Long	2	2	2	2	2	2	2	2	2	2	2	2	2	2	2		
- 7	2024	. . Plug, Pipe, 1/8 Inch NPT	1	1	1	1	1	1	1	1	1	1	1	1	1	1	1		
- 8	631618	. Plunger, Oil Pressure Relief Valve	1	1	1	1	1	1	1	1	1	1	1	1	1	1	1		
- 9	634150	. Spring, Oil Pressure Relief Valve	1	1	1	1	1	1	1	1	1	1	1	1	1	1	1		
-10	631653	. Washer, Special, Oil Pressure Relief Valve	1	1	1	1	1	1	1	1	1	1	1	1	1	1	1		
-11	632761	. Screw, Adjusting, Oil Pressure Relief Valve	1	1	1	1	1	1	1	1	1	1	1	1	1	1	1		
-12	AN900-18	& . Gasket, Annular	1	1	1	1	1	1	1	1	1	1	1	1	1	1	1		
-13	640919	. Housing, Oil Pressure Relief Valve	1	1	1	1	1	1	1	1	1	1	1	1	1	1	1		
-14	X1473	& . Gasket, Copper	1	1	1	1	1	1	1	1	1	1	1	1	1	1	1		
-15	632762	. Nut, Lock	1	1	1	1	1	1	1	1	1	1	1	1	1	1	1		
-16	627494	** . Plunger, Oil Pressure Relief Valve	1				1	1	1	1	1	1			1				
-17	627495	** . Spring, Oil Pressure Relief Valve	1				1	1	1	1	1	1			1				
-18	627651	** . Screw, Adjusting	1				1	1	1	1	1	1			1				
-19	627652	. Nut, Adjusting Screw	1				1	1	1	1	1	1			1				
-20	AN900-14	&** . Gasket, Annular	2				2	2	2	2	2	2			2				
-21	627650	** . Cap, Oil Pressure Relief Valve	1				1	1	1	1	1	1			1				
-22	537229	** . Plunger, Oil Pressure Relief Valve	1				1	1	1	1	1	1			1				
-22	538580	** . Plunger, Oil Pressure Relief Valve		1	1	1									1	1	1		
-23	627458	** . Spring, Oil Pressure Relief Valve		1	1	1									1	1	1		
-24	AN900-14	&** . Gasket, Annular		1	1	1									1	1	1		
-25	538736	** . Cap, Oil Pressure Relief Valve		1	1	1									1	1	1		
-26	631638	. Valve, By-Pass	1	1	1	1	1	1	1	1	1	1	1	1	1	1	1		
-27	631478	. Spring, By-Pass Valve	1	1	1	1	1	1	1	1	1	1	1	1	1	1	1		
-28	AN900-14	& . Gasket, Annular	1	1	1	1	1	1	1	1	1	1	1	1	1	1	1		
-29	631995	. Pin and Plug Assembly	1	1	1	1	1	1	1	1	1	1	1	1	1	1	1		
-30	2849	** . Ball, Filter By-Pass	1	1	1	1	1	1	1	1	1	1	1	1	1	1	1		
-31	2848	** . Spring, Filter By-Pass	1	1	1	1	1	1	1	1	1	1	1	1	1	1	1		
-32	AN900-10	&** . Gasket, Annular	1	1	1	1	1	1	1	1	1	1	1	1	1	1	1		
-33	532432	** . Plug, Filter By-Pass	1	1	1	1	1	1	1	1	1	1	1	1	1	1	1		
	539525	. Gear and Bushing Assembly, Oil Pump	1	1	1	1	1	1	1	1	1	1	1	1	1	1	1		
-34	No Number	. . Gear, Oil Pump Driven	ns	ns	ns	ns	ns	ns	ns	ns	ns	ns	ns	ns	ns	ns	ns		
-35	539523	. . Bushing, Oil Pump Gear	2	2	2	2	2	2	2	2	2	2	2	2	2	2	2		
	538516	. Gear Assembly, Oil Pump and Tach Drive	1									1	1				1		
	538609	. Gear Assembly, Oil Pump and Tach Drive	1				1	1	1	1				1	1	1	1		
-36	No Number	. . Gear, Oil Pump Drive	ns	ns	ns	ns	ns	ns	ns	ns	ns	ns	ns	ns	ns	ns	ns		
-37	535634	. . Dowel	1	1	1	1	1	1	1	1	1	1	1	1	1	1	1		
-38	535008	. Gear, Bevel, Tachometer Drive	1				1	1	1	1					1	1			
-39	535900	. Gear, Bevel, Tachometer Drive	1				1	1	1	1					1	1			
-40	625886	. Cover, Oil Pump, Mechanical Tach (For detail parts see Figure 25)	1				1	1	1	1				1	1	1			
-41	538789	. Cover, Oil Pump, Electric Tach (For detail parts see Figure 25)		1								1	1				1		
-42	538727	. Filter, Oil		1	1	1						1			1	1	1		
-43	Q9T116-218	. . Tube Assembly, Perforated		1	1	1						1			1	1	1		
-44	MS20073-04-10	. . Bolt, Drilled Hex Head		1	1	1						1			1	1	1		
-45	Q9S552-06	. . Washer, Annular, 1/4 Inch		1	1	1						1			1	1	1		
-46	535933	. . Gasket, Felt, 5/8 Inch ID		2	2	2						2			2	2	2		
-47	Q9T116-07	. . Element, Filter		1	1	1						1			1	1	1		
-48	628129	. . Body Casting, Filter		1	1	1						1			1	1	1		
-49	534862	. Screen Assembly, Oil	1				1	1	1	1	1			1					
-50	AN900-28	& . Gasket, Annular	1	1	1	1	1	1	1	1	1	1	1	1	1	1	1		

* If replacing old style pump body, service with 632563A11.
 ** Existence of these parts indicates early style pump. If pump is serviceable, these parts must be used to replace worn parts.

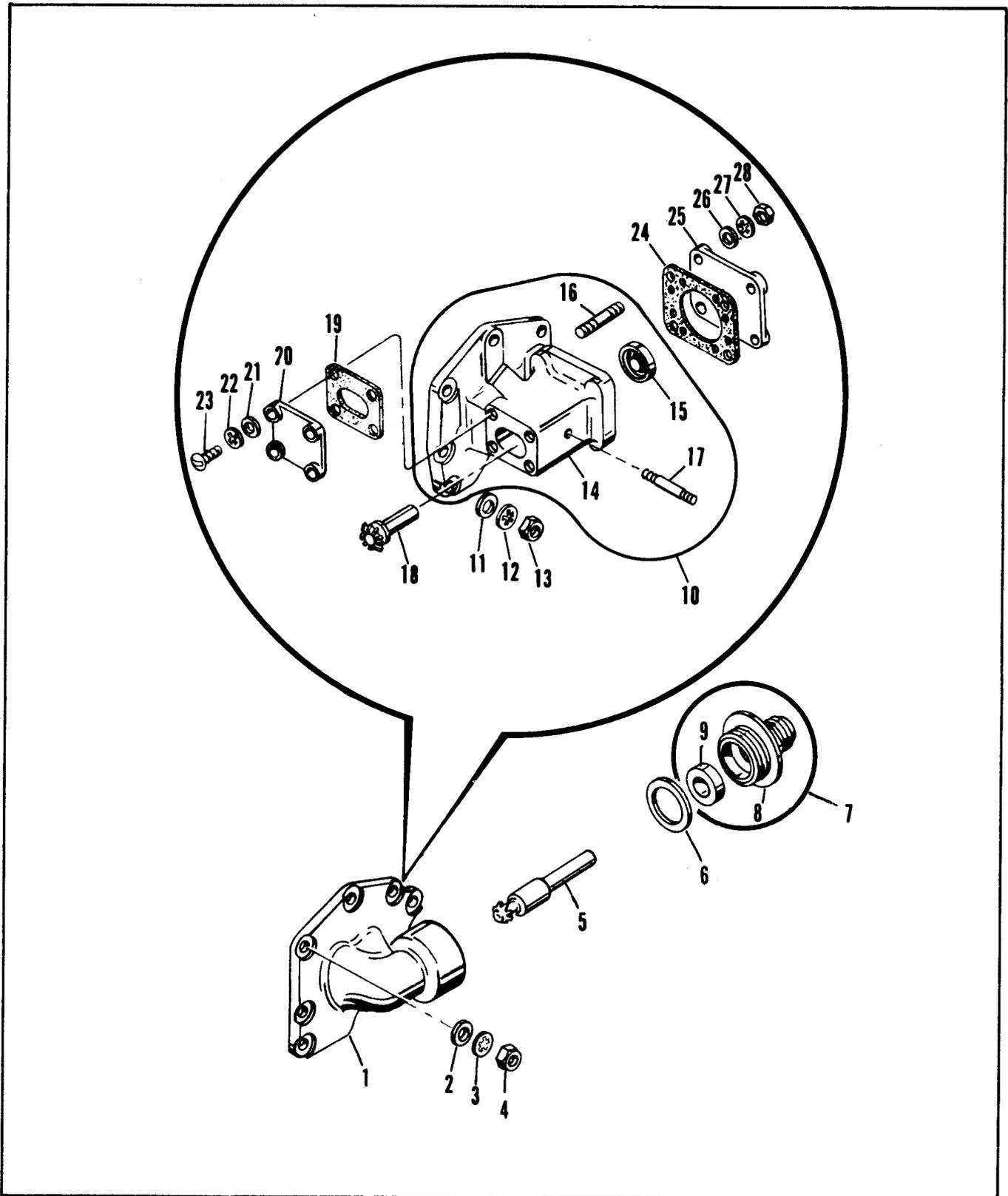

FIGURE 25. OIL PUMP COVER AND TACHOMETER DRIVE
 MODELS 10-470-C, D, E, F, G, H, J, K, L, M, N, P, R, S, U, V

FIG. & INDEX	PART NUMBER	DESCRIPTION	QUANTITY PER ASSEMBLY																
			C	D	E	F	G	H	J	K	L	M	N	P	R	S	U	V	
25- 1	625886	Cover, Oil Pump	Rf		Rf	Rf	Rf	Rf	Rf	Rf				Rf		Rf	Rf		
		ATTACHING PARTS																	
- 2	20522	Washer, Plain	2		2	2	2	2	2	2				2		2	2		
- 3	MS35338-44	Washer, Lock	2		2	2	2	2	2	2				2		2	2		
- 4	2437	Nut, Plain, Hex	2		2	2	2	2	2	2				2		2	2		
		* * * *																	
- 5	631650	Shaft and Gear Assembly	1		1	1	1	1	1	1				1		1	1		
- 6	632085	& Gasket, Annular	1		1	1	1	1	1	1				1		1	1		
- 7	21208A1	Housing Assembly, Tach Drive	1		1	1	1	1	1	1				1		1	1		
- 8	No Number	. Housing	1		1	1	1	1	1	1				1		1	1		
- 9	21163	& . Seal, Oil	1		1	1	1	1	1	1				1		1	1		
-10	538789	Cover Assembly, Oil Pump		Rf								Rf			Rf			Rf	Rf
-10	628859	Cover Assembly, Oil Pump											Rf						
		ATTACHING PARTS																	
-11	20522	Washer, Plain		2								2	2		2			2	2
-12	MS35338-44	Washer, Lock		2								2	2		2			2	2
-13	2437	Nut, Plain, Hex		2								2	2		2			2	2
		* * * *																	
-14	No Number	. Cover	ns									ns	ns		ns			ns	ns
-15	531378	& . Seal, Oil	1									1	1		1			1	1
-16	401963	† . Stud, 1/4 X 1-1/4 Inch Long	4									4	4		4			4	4
-17	401816	† . Stud, 1/4 X 1-11/16 Inch Long											1						
-18	535908	Gear, Bevel, Tach Drive	1									1	1		1			1	1
-19	535885	& Gasket	1									1	1		1			1	1
-20	535887	Cover, Tach Gear Box	1									1	1		1			1	1
		ATTACHING PARTS																	
-21	2471	Washer, Plain	4									4	4		4			4	4
-22	22910	Washer, Lock	4									4	4		4			4	4
-23	20655	Screw	4									4	4		4			4	4
		* * * *																	
-24	AN4045-1	& Gasket	1									1	1		1			1	1
-25	633068	Cover, Tach Drive Pad	1									1	1		1			1	1
		ATTACHING PARTS																	
-26	531547	Washer, Plain	4									4	4		4			4	4
-27	MS35338-44	Washer, Lock	4									4	4		4			4	4
-28	2437	Nut, Plain, Hex	4									4	4		4			4	4
		* * * *																	

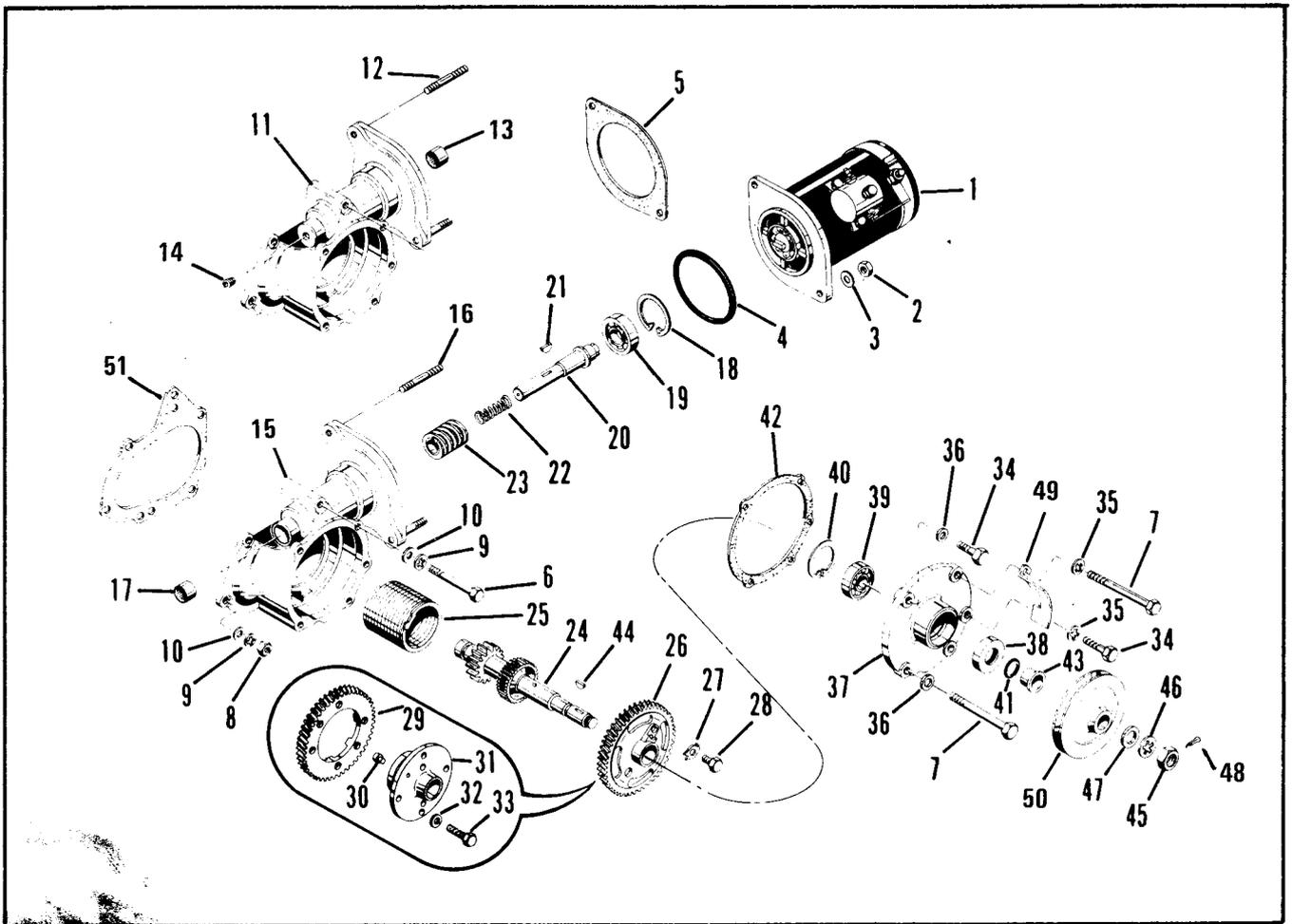

FIGURE 26. STARTER AND STARTER ADAPTER
MODELS O-470-A, B, E, G, J, K, L, M, P, R, S

FIG. & INDEX	PART NUMBER	DESCRIPTION	QUANTITY PER ASSEMBLY																		
			A	B	E	G	J	K	L	M	P	R	S								
26- 1	535856	@ Starter, 12 Volt	1																		
- 1	627841	@ Starter, 24 Volt		1								1									
- 1	631261	@ Starter, 12 Volt			1																
- 1	626960	@ Starter, 12 Volt													1						
- 1	628482	@ Starter, 12 Volt				1	1	1	1									1			
- 1	634592	@ Starter, 12 Volt																			1
ATTACHING PARTS																					
- 2	2441	Nut, Hex	2	2	2	2	2	2	2	2	2	2	2	2	2	2	2	2	2	2	2
- 3	539058	Washer, Plain	2	2	2	2	2	2	2	2	2	2	2	2	2	2	2	2	2	2	2
		* * * *																			
- 4	MS9021-038	& O-Ring			1	1	1	1	1	1	1	1						1		1	
- 5	534316	& Gasket, Starter	1															1			
	537743A2	Adapter Assembly, Starter, Complete	1																		
	635050A4	Adapter Assembly, Starter, Complete	1	1	1	1	1	1	1	1	1	1	1	1	1	1	1	1	1	1	1
ATTACHING PARTS																					
- 6	537742	Bolt, 5/16-18 x 2-13/16 Inch Long	1	1	1	1	1	1	1	1	1	1	1	1	1	1	1	1	1	1	1
- 7	538999	Bolt, 5/16-18 x 3-5/8 Inch Long	3	3	3	3	3	3	3	3	3	3	3	3	3	3	3	3	3	3	3
- 8	2439	Nut, Hex	2	2	2	2	2	2	2	2	2	2	2	2	2	2	2	2	2	2	2
- 9	MS35338-45	Washer, Lock	4	4	4	4	4	4	4	4	4	4	4	4	4	4	4	4	4	4	5
-10	2473	Washer, Plain	4	4	4	4	4	4	4	4	4	4	4	4	4	4	4	4	4	4	5
-11	537743	Adapter Assembly, Starter	1																		

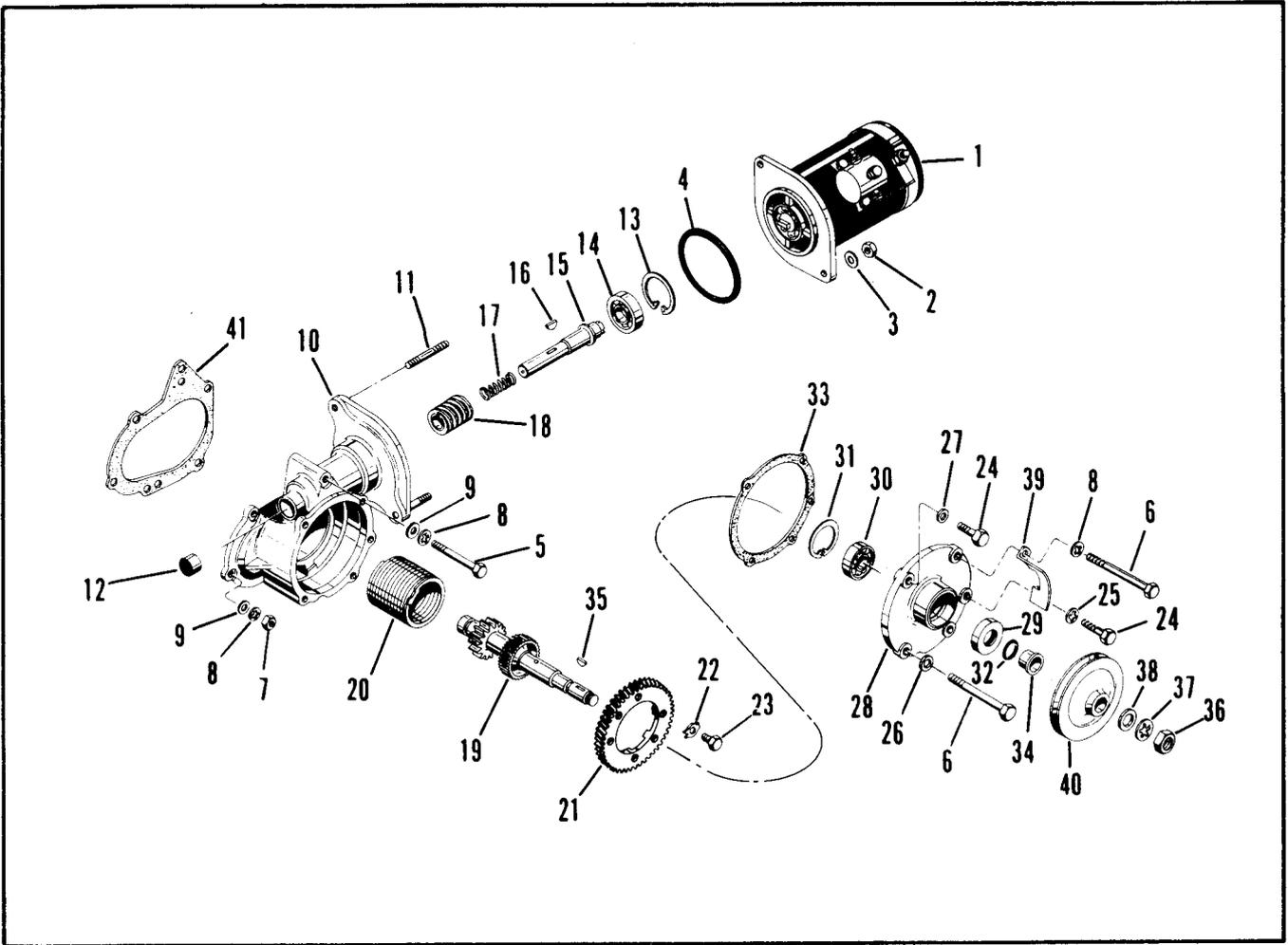

FIGURE 27. STARTER AND STARTER ADAPTER
 MODELS 10-470-C, D, E, F, G, H, J, K, L, M, N, P, R, S, U, V

FIG. & INDEX	PART NUMBER	DESCRIPTION	QUANTITY PER ASSEMBLY																				
			C	D	E	F	G	H	J	K	L	M	N	P	R	S	U	V					
27- 1	637487	@ Starter, 24 Volt				1							1	1	1	1					1	1	
- 1	631261	@ Starter, 12 Volt					1														1		
- 1	629176	@ Starter, 12 Volt																				1	
- 1	628482	@ Starter, 12 Volt	1	1	1				1	1	1												
		ATTACHING PARTS																					
- 2	2441	Nut, Hex	2	2	2	2	2	2	2	2	2	2	2	2	2	2	2	2	2	2	2	2	2
- 3	539058	Washer, Plain	2	2	2	2	2	2	2	2	2	2	2	2	2	2	2	2	2	2	2	2	2
		* * * *																					
- 4	MS9021-038	& O-Ring	1	1	1	1	1	1	1	1	1	1	1	1	1	1	1	1	1	1	1	1	1
	635050A4	Adapter Assembly, Starter, Complete	1	1	1	1	1	1	1	1	1	1	1	1	1	1	1	1	1	1	1	1	1
		ATTACHING PARTS																					
- 5	537742	Bolt, 5/16-18 X 2-13/16 Inch Long	1	1	1	1	1	1	1	1	1	1	1	1	1	1	1	1	1	1	1	1	1
- 6	538999	Bolt, 5/16-18 X 3-5/8 Inch Long	3	3	3	3	3	3	3	3	3	3	3	3	3	3	3	3	3	3	3	3	3
- 7	2439	Nut, Hex	2	2	2	2	2	2	2	2	2	2	2	2	2	2	2	2	2	2	2	2	2
- 8	MS35338-45	Washer, Lock	4	4	4	4	4	4	4	4	4	4	4	3	4	4	4	4	4	4	4	4	4
- 9	2473	Washer, Plain	4	4	4	4	4	4	4	4	4	4	4	3	3	4	4	4	4	4	4	4	4
- 9	2473	Washer, Plain													1								

FIG. & INDEX	PART NUMBER	DESCRIPTION	QUANTITY PER ASSEMBLY																
			C	D	E	F	G	H	J	K	L	M	N	P	R	S	U	V	
27-10	635050	. Adapter Assembly, Starter	1	1	1	1	1	1	1	1	1	1	1	1	1	1	1	1	1
-11	402127	† . Stud 3/8 X 1-17/32 Inch Long	2	2	2	2	2	2	2	2	2	2	2	2	2	2	2	2	2
-12	629713	† . Bearing, Needle	1	1	1	1	1	1	1	1	1	1	1	1	1	1	1	1	1
-13	502287	. Ring, Internal Retaining	1	1	1	1	1	1	1	1	1	1	1	1	1	1	1	1	1
-14	X13041	. Bearing, Ball	1	1	1	1	1	1	1	1	1	1	1	1	1	1	1	1	1
-15	631252	. Shaft, Worm Drive	1	1	1	1	1	1	1	1	1	1	1	1	1	1	1	1	1
-16	MS35756-8	. Key, Woodruff	1	1	1	1	1	1	1	1	1	1	1	1	1	1	1	1	1
-17	536552	. Spring, Starter	1	1	1	1	1	1	1	1	1	1	1	1	1	1	1	1	1
-18	539805	. Gear, Starter Worm	1	1	1	1	1	1	1	1	1	1	1	1	1	1	1	1	1
-19	539568	. Shaftgear, Starter	1	1	1	1	1	1	1	1	1	1	1	1	1	1	1	1	1
-20	539800	† . Spring, Clutch	1	1	1	1	1	1	1	1	1	1	1	1	1	1	1	1	1
-21	539785	. Gear, Starter Worm Wheel	1	1	1	1	1	1	1	1	1	1	1	1	1	1	1	1	1
-22	501867	. Washer, Tab	1	1	1	1	1	1	1	1	1	1	1	1	1	1	1	1	1
-23	633845	. Screw, 1/4-20 X 13/32 Inch Long	1	1	1	1	1	1	1	1	1	1	1	1	1	1	1	1	1
	537738A1	. Cover Assembly, Starter Adapter	1	1	1	1	1	1	1	1	1	1	1	1	1	1	1	1	1
		ATTACHING PARTS																	
-24	537750	. Bolt, 5/16-18 X 1-1/8 Inch Long	2	2	2	2	2	2	2	2	2	2	2	2	2	2	2	2	2
-25	MS35338-45	. Washer, Lock	2	2	2	2	2	2	2	2	2	2	2	2	2	2	2	2	2
-26	2473	. Washer, Plain	2	2	2	2	2	2	2	2	2	2	2	2	2	2	2	2	2
-27	501868	. Washer, Tab	1	1	1	1	1	1	1	1	1	1	1	1	1	1	1	1	1
		* * * *																	
-28	No Number	. . Cover, Starter Adapter	ns	ns	ns	ns	ns	ns	ns	ns	ns	ns	ns	ns	ns	ns	ns	ns	
-29	534938	& . . Seal, Oil	1	1	1	1	1	1	1	1	1	1	1	1	1	1	1	1	1
-30	534685	. . Bearing, Ball	1	1	1	1	1	1	1	1	1	1	1	1	1	1	1	1	1
-31	534715	. . Ring, Internal Retaining	1	1	1	1	1	1	1	1	1	1	1	1	1	1	1	1	1
-32	AN123862	& . Seal, O-Ring	1	1	1	1	1	1	1	1	1	1	1	1	1	1	1	1	1
-33	537749	& . Gasket, Cover	1	1	1	1	1	1	1	1	1	1	1	1	1	1	1	1	1
-34	534980	. Sleeve, Bearing Retaining	1	1	1	1	1	1	1	1	1	1	1	1	1	1	1	1	1
-35	MS35756-8	. Key, Woodruff	1	1	1	1	1	1	1	1	1	1	1	1	1	1	1	1	1
-36	AN316-9	. Nut, Check	1	1	1	1	1	1	1	1	1	1	1	1	1	1	1	1	1
-37	13XX299	. Washer, Lock	1	1	1	1	1	1	1	1	1	1	1	1	1	1	1	1	1
-38	AN960C916	. Washer, Plain	1	1	1	1	1	1	1	1	1	1	1	1	1	1	1	1	1
-39	628760	Indicator, Engine Timing	1	1	1	1	1	1	1	1	1	1	1	1	1	1	1	1	1
-40	534775	@ Sheave, Generator Drive	1	1	1	1	1	1	1	1	1	1	1	1	1	1	1	1	1
-40	628319	@ Sheave, Generator Drive																1	1
-41	537745	& Gasket, Adapter	1	1	1	1	1	1	1	1	1	1	1	1	1	1	1	1	1

@ See Section VI For Specification Applications.

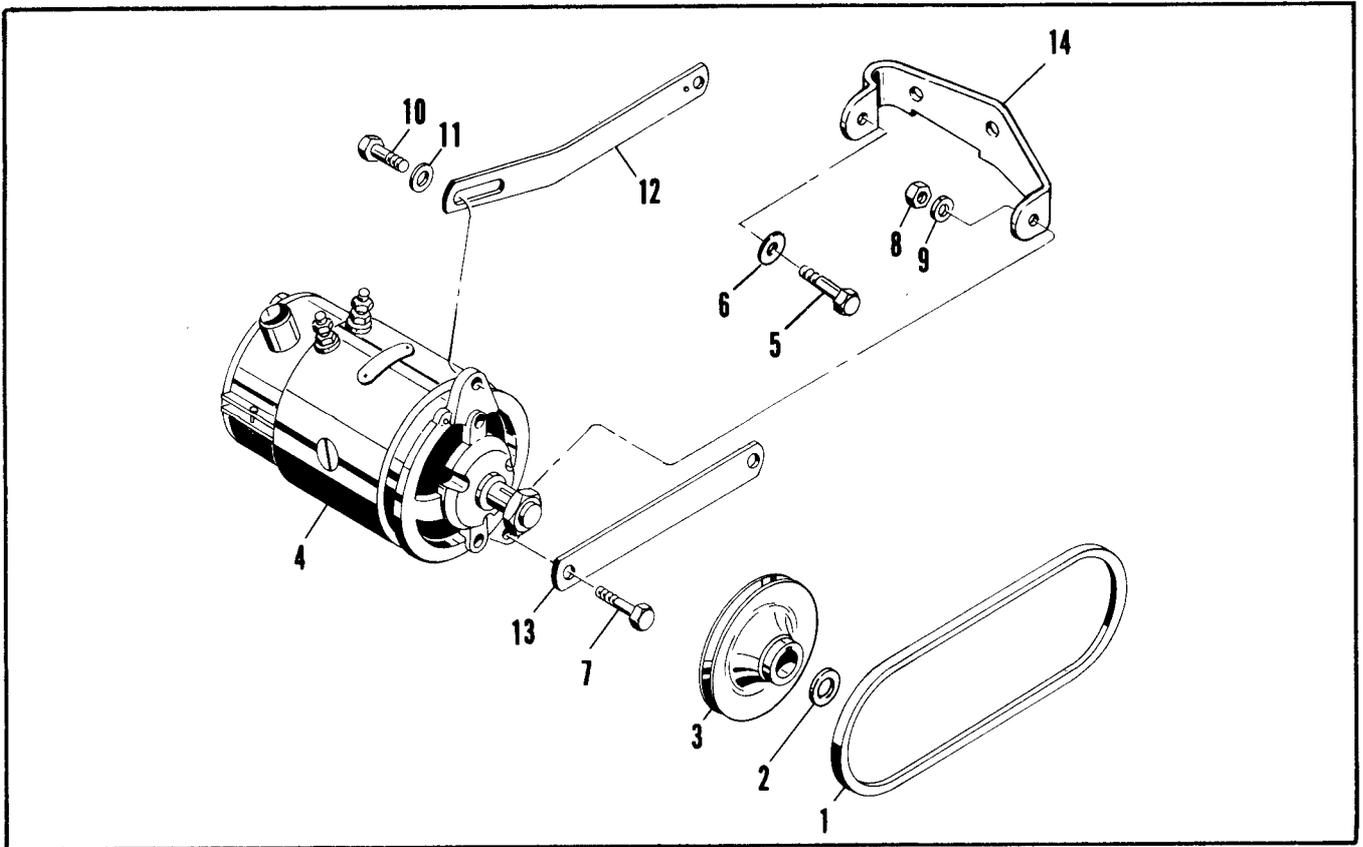

FIGURE 28. GENERATOR AND MOUNTING
MODELS O-470-A, B, E, G, J, K, L, M, P, R

FIG. & INDEX	PART NUMBER	DESCRIPTION	QUANTITY PER ASSEMBLY											
			A	B	E	G	J	K	L	M	P	R		
28- 1	539547-31.19	Belt, Generator Drive	1	1	1	1	1	1	1	1	1	1	1	1
- 2	535541	Spacer, Sheave			1	1	1	1	1				1	1
- 2	536213	Spacer, Sheave		1							1			
- 3	534787	@ Sheave, Generator Drive	1	1	1	1	1	1	1	1	1	1	1	1
- 4	535928	@ Generator, 24 Volt									1			
- 4	627272	@ Generator, 12 Volt, 50 Amp				1						1		
- 4	627274	@ Generator, 24 Volt, 25 Amp		1										
- 4	627273	@ Generator, 12 Volt, 35 Amp	1		1		1	1	1				1	
ATTACHING PARTS														
- 5	AN5-10A	Bolt	1	1	1	1	1	1	1	1	1	1	1	1
- 6	2473	Washer, Plain, 5/16 Inch	1	1	1	1	1	1	1	1	1	1	1	1
- 7	AN101218	Bolt		1	1	1	1	1	1	1	1	1	1	1
- 7	AN101217	Bolt	1											
- 8	AN315-5R	Nut, Plain, Hex	2	2	2	2	2	2	2	2	2	2	2	2
- 9	401506	Washer, Plain, 21/64 Inch	2	2	2	2	2	2	2	2	2	2	2	2
-10	AN75A6	Bolt	1	1	1	1	1	1	1	1	1	1	1	1
-11	537539	Washer, Plain	1	2	2	2	2	2	2	2	2	2	2	2
* * * *														
-12	538346	@ Arm, Generator Belt Adjusting				1							1	
-13	538070	@ Arm, Generator Belt Adjusting	1	1	1		1	1	1	1	1		1	
-13	538069	@ Bracket, Generator Support	1	1	1	1	1	1	1	1	1	1	1	1
-14	539579	@ Bracket, Generator Mounting	1	1	1	1	1	1	1	1	1	1	1	1

@ See Section VI For Specification Applications.

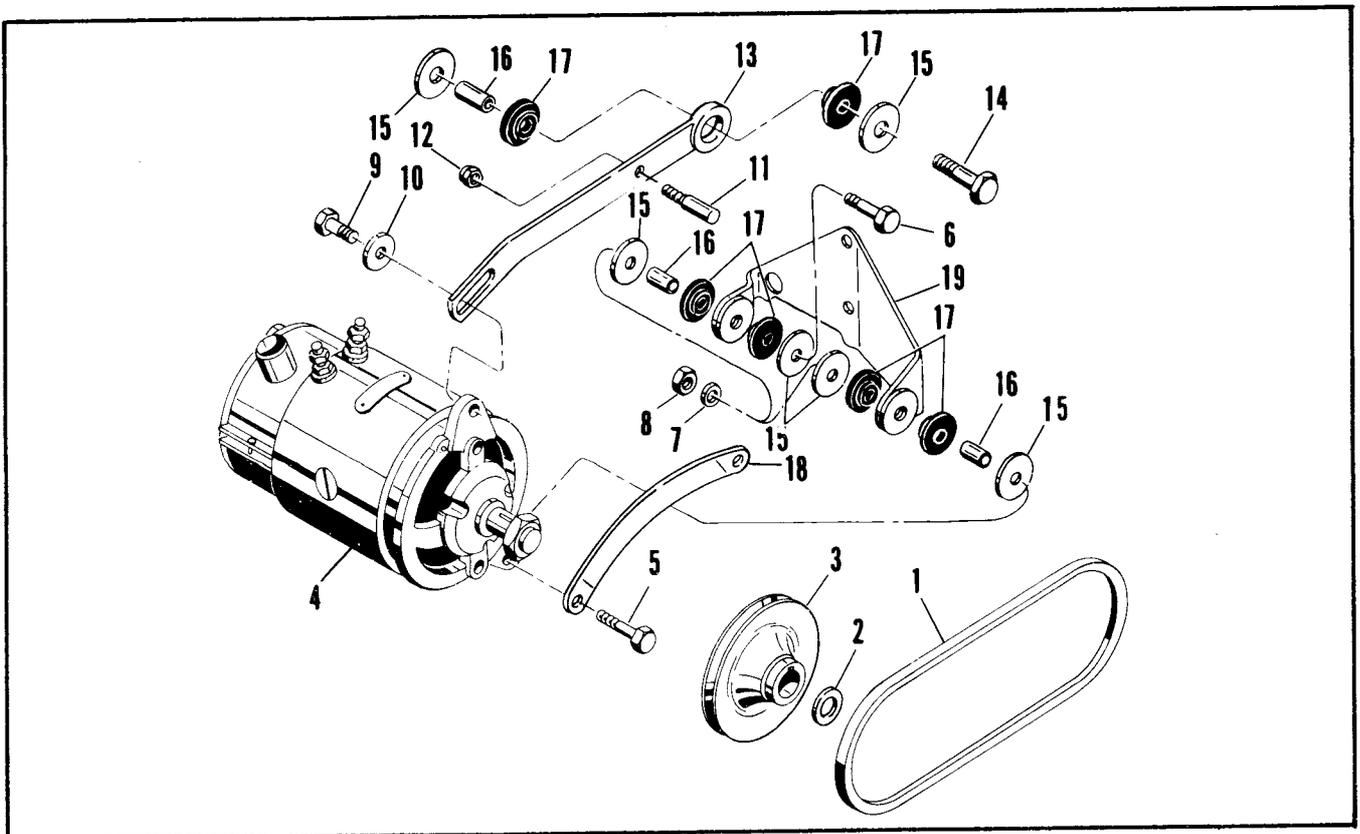

FIGURE 29. GENERATOR AND MOUNTING BRACKETS
MODELS 10-470-C, D, E, F, G, H, J, K, L, N, P, R, S

FIG. & INDEX	PART NUMBER	DESCRIPTION	QUANTITY PER ASSEMBLY															
			C	D	E	F	G	H	J	K	L	M	N	P	R	S	U	V
29- 1	539547-31.19	Belt, Generator Drive	1	1	1	1	1	1	1	1	1	1	1	1	1	1	1	1
- 2	536213	Washer	1	1	1	1	1	1	1	1	1	1	1	1	1	1	1	1
- 3	627377	@ Sheave, Generator Drive	1	1	1	1	1	1	1	1	1	1	1	1	1	1	1	1
- 4	627272	@ Generator, 12 Volt, 50 Amp	1			1		1						1				1
- 4	627273	@ Generator, 12 Volt, 35 Amp			1		1		1	1							1	
- 4	627274	@ Generator, 24 Volt, 25 Amp		1														
- 4	630686	@ Generator, 24 Volt, 25 Amp											1					
ATTACHING PARTS																		
- 5	AN5-16A	Bolt	1	1	1	1	1	1	1	1	1	1	1	1	1	1	1	1
- 6	AN5-15A	Bolt	1	1	1	1	1	1	1	1	1	1	1	1	1	1	1	1
- 7	2473	Washer, Plain	1	1	1	1	1	1	1	1	1	1	1	1	1	1	1	1
- 8	2439	Nut, Plain, Hex	2	2	2	2	2	2	2	2	2	2	2	2	2	2	2	2
- 9	AN75A6	Bolt	1	1	1	1	1	1	1	1	1	1	1	1	1	1	1	1
-10	537539	Washer, Special	1	1	1	1	1	1	1	1	1	1	1	1	1	1	1	1
		* * * *																
-11	627673	Idler, Kiss	1	1	1	1	1	1	1	1	1	1	1	1	1	1	1	1
-12	22661	Nut, Elastic Stop	1	1	1	1	1	1	1	1	1	1	1	1	1	1	1	1
-13	627276	@ Arm, Generator Belt Adjusting	1	1	1	1	1	1	1	1	1	1	1	1	1	1	1	1
-14	AN75A15	Bolt	1	1	1	1	1	1	1	1	1	1	1	1	1	1	1	1
-15	627279	Washer, Special	6	6	6	6	6	6	6	6	6	6	6	6	6	6	6	6
-16	627281	Bushing	3	3	3	3	3	3	3	3	3	3	3	3	3	3	3	3
-17	627282	Bushing, Rubber	6	6	6	6	6	6	6	6	6	6	6	6	6	6	6	6
-18	627068	@ Bracket, Generator Support	1	1	1	1	1	1	1	1	1	1	1	1	1	1	1	1
-19	627277	@ Bracket, Generator Mounting		1								1			1			
-19	627690	@ Bracket, Generator Mounting	1		1	1	1	1	1	1	1	1	1	1	1	1	1	1

@ See Section VI For Specification Applications.

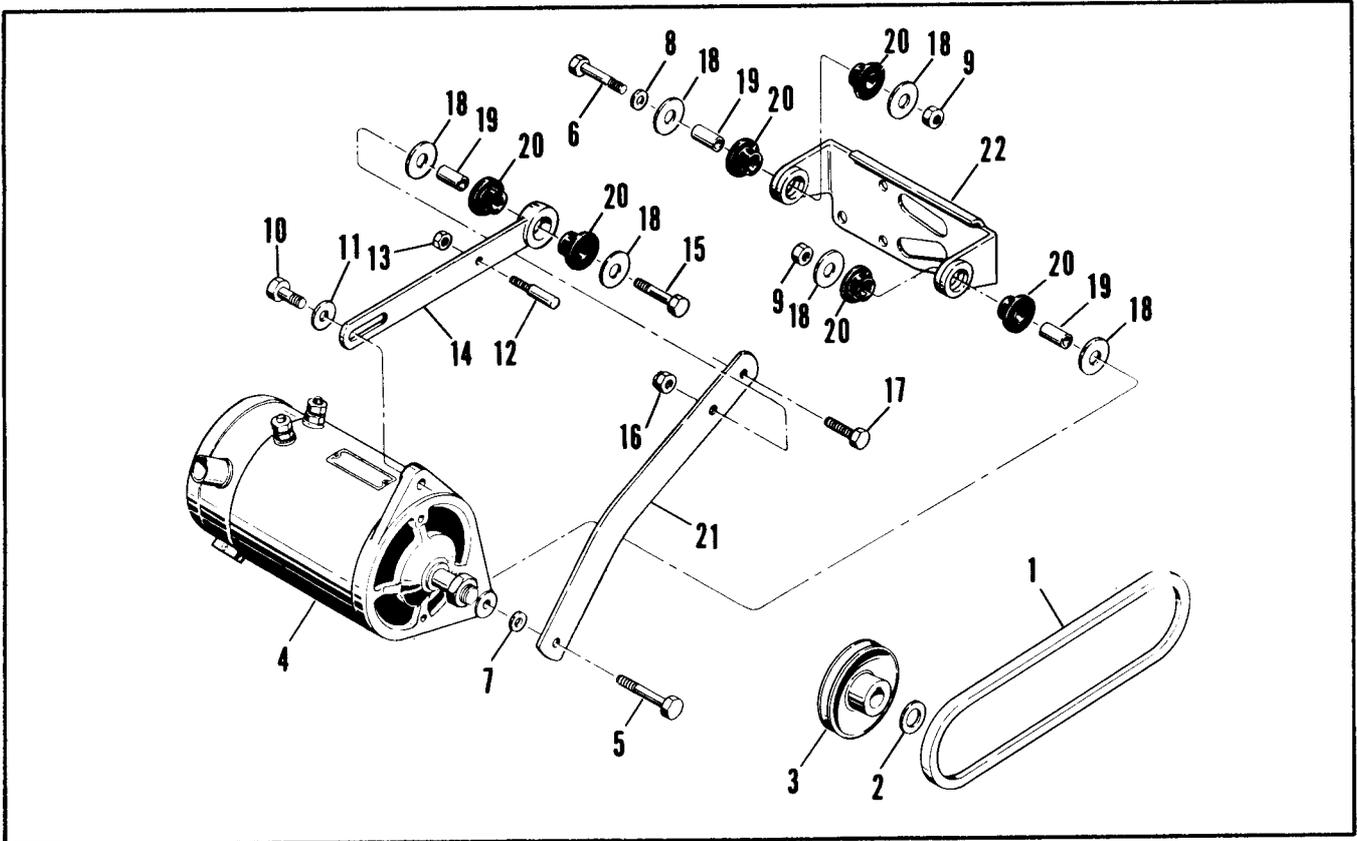

FIGURE 31. GENERATOR AND MOUNTING
MODELS 10-470-U, V

FIG. & INDEX	PART NUMBER	DESCRIPTION	QUANTITY PER ASSEMBLY																
			C	D	E	F	G	H	J	K	L	M	N	P	R	S	U	V	
31- 1	539547-30.00	Belt, Generator Drive																1	1
- 2	536213	Washer																1	1
- 3	628005	@ Sheave, Generator Drive																1	1
- 4	629417	@ Generator, 24 Volt, 50 Amp																1	1
		ATTACHING PARTS																	
- 5	AN5-17A	Bolt																1	1
- 6	AN75-16	Bolt																1	1
- 7	2555	Washer, Plain, 5/16																1	1
- 8	2473	Washer, Plain, 5/16																1	1
- 9	2439	Nut, Plain, Hex																2	2
-10	AN75A6	Bolt																1	1
-11	537539	Washer, Plain, 11/32																1	1
		* * * *																	
-12	627673	Idler, Kiss																1	1
-13	22661	Nut, Elastic Stop, 1/4																1	1
-14	628580	@ Arm, Generator Belt Adjusting																1	1
-15	538607	Bolt, 5/16 X 1-15/32 Inch Long																1	1
-16	21213	Nut, Elastic Stop																1	1
-17	AN75A10	Bolt																1	1
-18	627279	Washer, Special, 21/64																6	6
-19	627281	Bushing																3	3
-20	630519	Bushing, Rubber																6	6
-21	628583	@ Bracket, Generator Support																1	1
-22	628004	@ Bracket, Generator Mounting																1	1

@ See Section VI For Specification Applications.

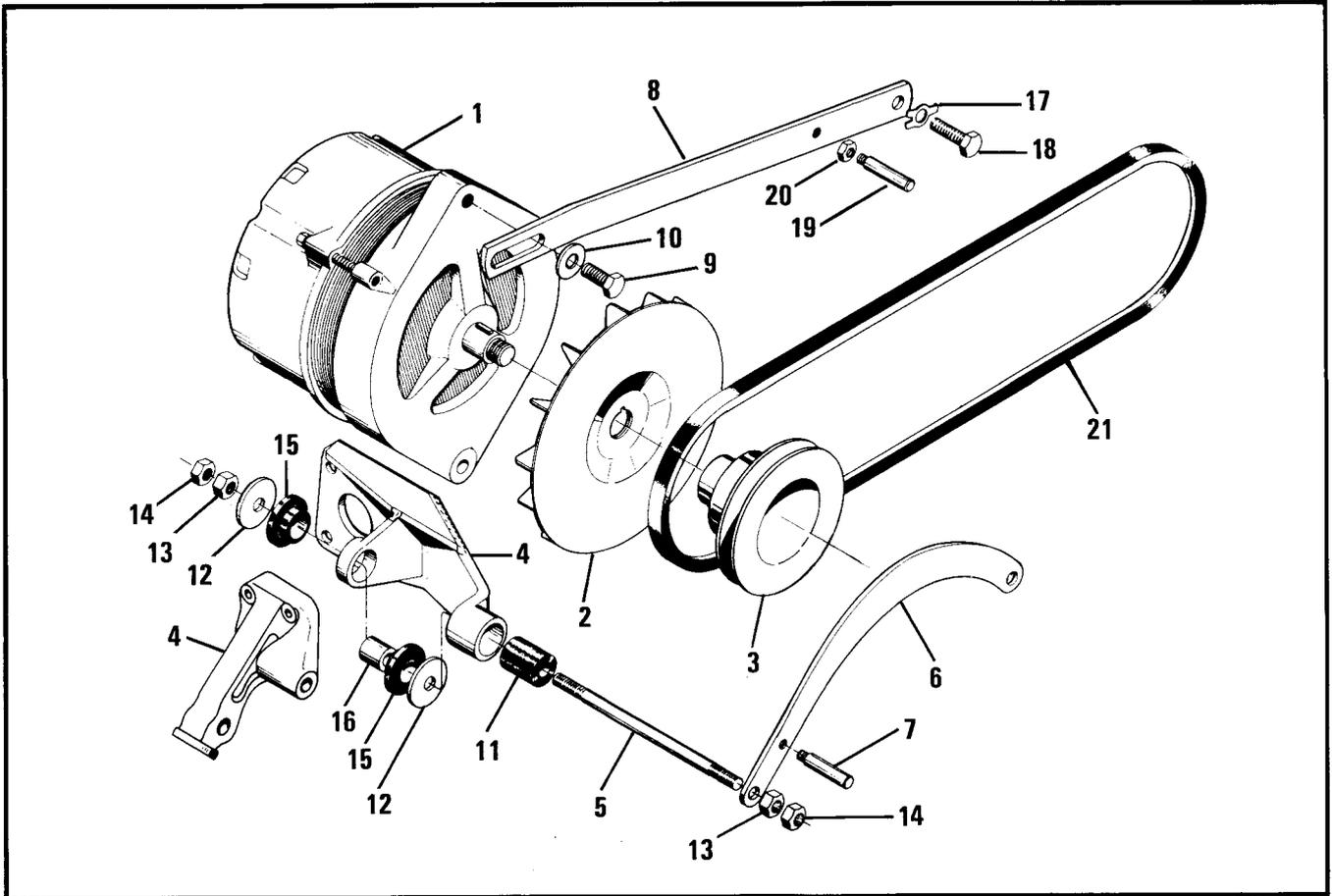

FIGURE 32. ALTERNATOR (OPTIONAL EQUIPMENT)

FIG. & INDEX	PART NUMBER	DESCRIPTION	QUANTITY PER ASSEMBLY																		
			ALL MODELS																		
32- 1	631111	Alternator										1									
- 2	631094	Fan, Alternator											1								
- 3	630985	Sheave, Alternator Driven											1								
- 4	631000	Bracket Assembly											1								
- 4	634673	Bracket, Engine Mount and Alternator											1								
- 5	630989	Shaft, Alternator Mount											1								
- 6	631200	Bracket Assembly, Alternator Support, Lower											1								
- 7	631202	Idler, Kiss											1								
- 8	632312	Bracket, Alternator Adjusting Arm, Upper											1								
- 9	628730	Screw, Bracket at Alternator											1								
-10	537539	Washer, Bracket at Alternator											1								
-11	630988	Bushing, Rubber, Lower Support											1								
-12	633062	Washer, Lower Support											2								
-13	2439	Nut, Plain											2								
-14	2560	Palnut											2								
-15	630519	Bushing, Rubber											2								
-16	627281	Bushing											1								
-17	501868	Washer, Tab											1								
-18	537750	Screw											1								
-19	627673-2	Idler, Kiss											1								
-20	22661	Nut, Elastic Stop											1								
-21	539547-31.19	Belt											1								

Optional for all O-470/IO-470 Models.
See Section VI for customer specification.

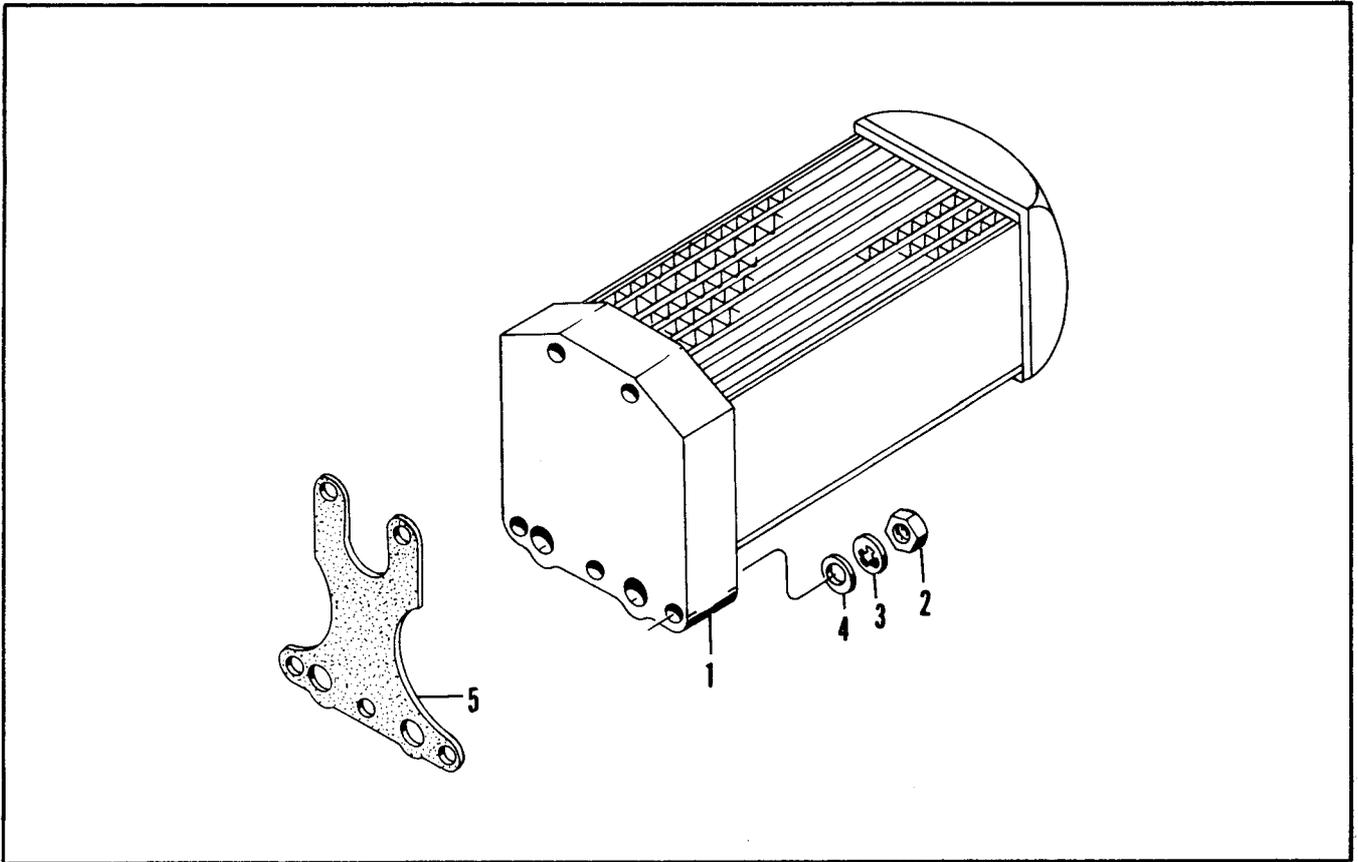

FIGURE 33. OIL COOLER

MODELS O-470-A, E, J, K

FIG. & INDEX	PART NUMBER	DESCRIPTION	QUANTITY PER ASSEMBLY																	
			A	B	E	G	J	K	L	M	P	R								
33- 1	534503	@ Cooler, Engine Oil	1		1			1	1											
		ATTACHING PARTS																		
- 2	2437	Nut, Plain Hex	5		5			5	5											
- 3	MS35338-44	Washer, Lock	5		5			5	5											
- 4	20522	Washer, Plain	5		5			5	5											
		* * * *																		
- 5	625303	& Gasket, Oil Cooler-to-Crankcase	1		1			1	1											

@ See Section VI For Specification Applications.

MODEL 10-470-F

FIG. & INDEX	PART NUMBER	DESCRIPTION	QUANTITY PER ASSEMBLY																		
			C	D	E	F	G	H	J	K	L	M	N	P	R	S	U	V			
33- 1	534503	@ Cooler, Engine Oil				1															
		ATTACHING PARTS																			
- 2	2437	Nut, Plain Hex				5															
- 3	MS35338-44	Washer, Lock				5															
- 4	20522	Washer, Plain				5															
		* * * *																			
- 5	625303	& Gasket, Oil Cooler-to-Crankcase				1															

@ See Section VI For Specification Applications.

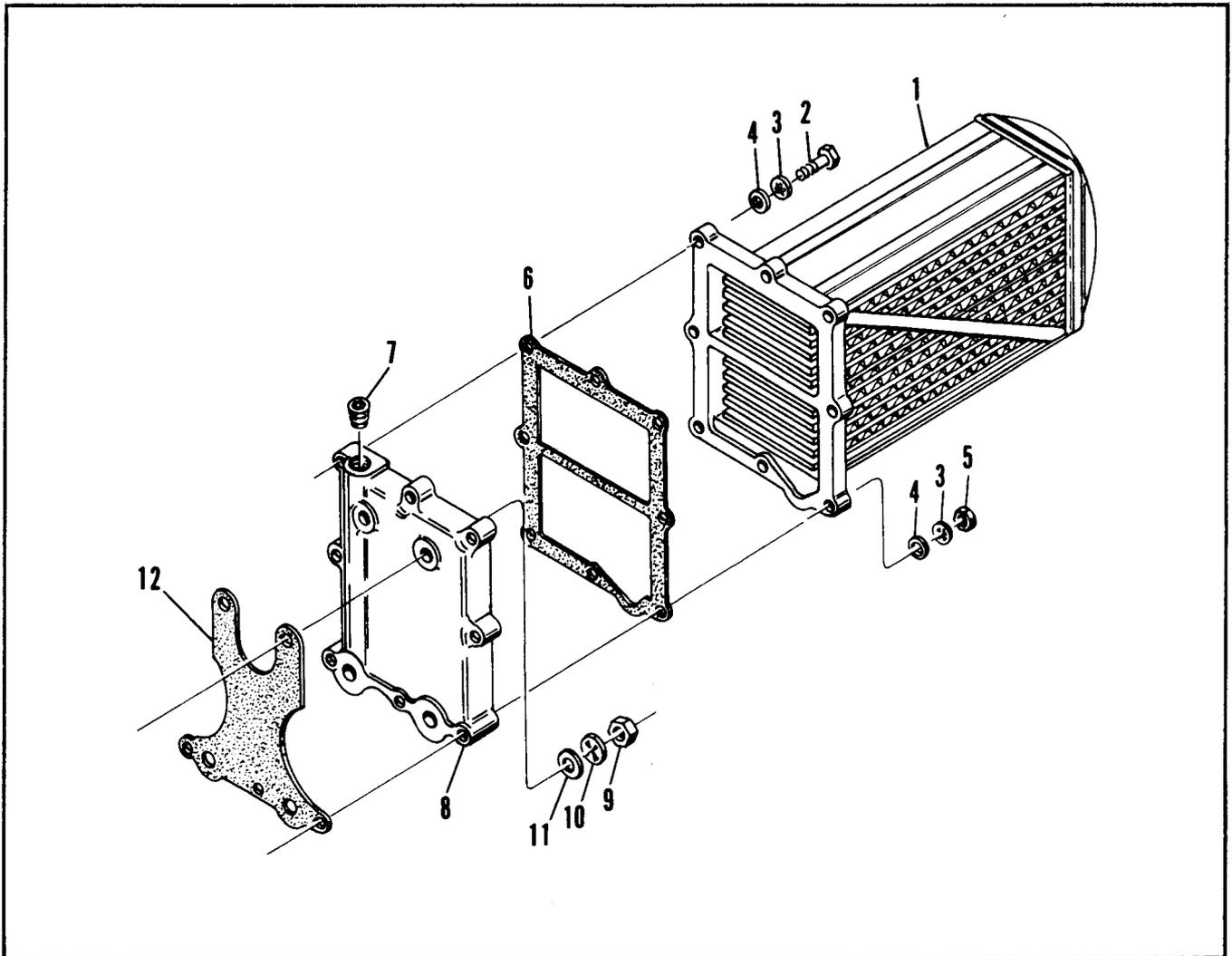

FIGURE 34. OIL COOLER
MODELS O-470-G,L,P,R,S

FIG. & INDEX	PART NUMBER	DESCRIPTION	QUANTITY PER ASSEMBLY												
			A	B	E	G	J	K	L	M	P	R	S		
34- 1	627392	@ Cooler, Engine Oil					1			1			1	1	1
		ATTACHING PARTS													
- 2	535631	Screw, 1/4 X 1 Inch Long					5			5			5	5	5
- 3	MS35338-44	Washer, Lock					8			8			8	8	8
- 4	20522	Washer, Plain					8			8			8	8	8
- 5	2437	Nut, Plain, Hex					3			3			3	3	3
		* * * *													
- 6	625017	& Gasket, Oil Cooler-to-Plate					1			1			1	1	1
- 7	2026	Plug, Pipe, 1/4 Inch					1			1			1	1	1
- 8	625016	Plate, Oil Cooler Adapter					1			1			1	1	1
		ATTACHING PARTS													
- 9	2437	Nut, Plain, Hex					2			2			2	2	2
-10	MS35338-44	Washer, Lock					2			2			2	2	2
-11	20522	Washer, Plain					2			2			2	2	2
		* * * *													
-12	625303	& Gasket, Plate-to-Crankcase					1			1			1	1	1

@ See Section VI For Specification Applications.

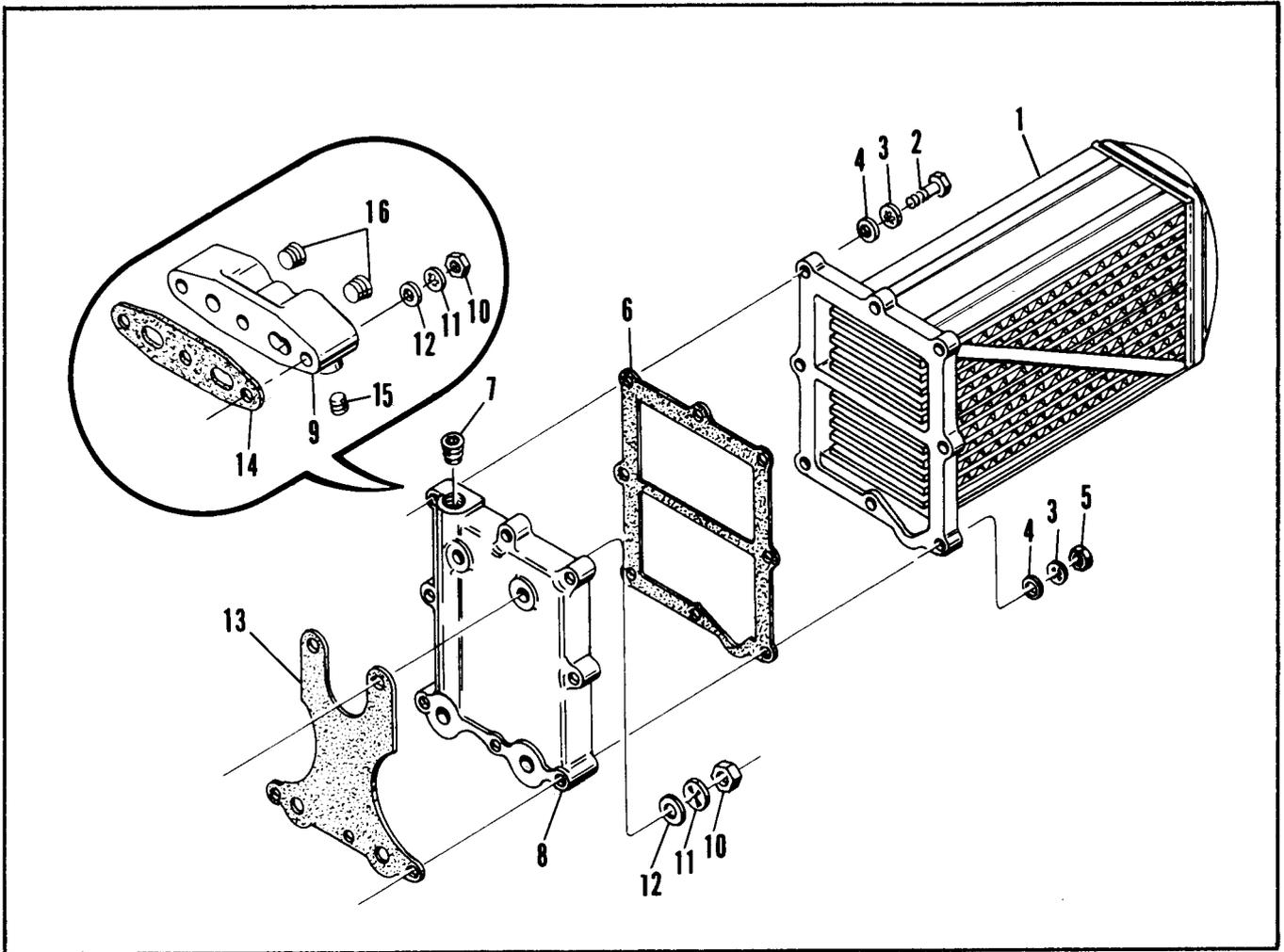

FIGURE 35. OIL COOLER
MODELS 10-470-C, E, G, H, J, K, N, R, S

FIG. & INDEX	PART NUMBER	DESCRIPTION	QUANTITY PER ASSEMBLY															
			C	D	E	F	G	H	J	K	L	M	N	P	R	S	U	V
35- 1	627392	@ Cooler, Engine Oil	1		1		1	1	1	1				1		1	1	
		ATTACHING PARTS																
- 2	535631	Screw, 1/4 X 1 Inch Long	5		5		5	5	5	5				5		5	5	
- 3	MS35338-44	Washer, Lock	8		8		8	8	8	8				8		8	8	
- 4	20522	Washer, Plain	8		8		8	8	8	8				8		8	8	
- 5	2437	Nut, Plain Hex	3		3		3	3	3	3				3		3	3	
		* * * *																
- 6	625017	& Gasket, Oil Cooler-to-Plate	1		1		1	1	1	1				1		1	1	
- 7	2026	Plug, Pipe, 1/4 Inch	1		1		1	1	1	1				1		1	1	
- 8	625016	Plate, Oil Cooler Adapter	1		1		1	1	1	1				1		1	1	
- 9	535958	Adapter, Oil Cooler Pad														1		
		ATTACHING PARTS																
-10	2437	Nut, Plain, Hex	2		2		2	2	2	2				2	3	2	2	
-11	MS35338-44	Washer, Lock	2		2		2	2	2	2				2	3	2	2	
-12	20522	Washer, Plain	2		2		2	2	2	2				2	3	2	2	
		* * * *																
-13	625303	& Gasket, Plate-to-Crankcase	1		1		1	1	1	1				1		1	1	
-14	535756	& Gasket, Adapter-to-Crankcase														1		
-15	401763	Plug, Pipe, 1/4 Inch NPT														1		
-16	530028	Plug, Pipe, 1/2 Inch NPT														2		

@ See Section VI For Specification Applications.

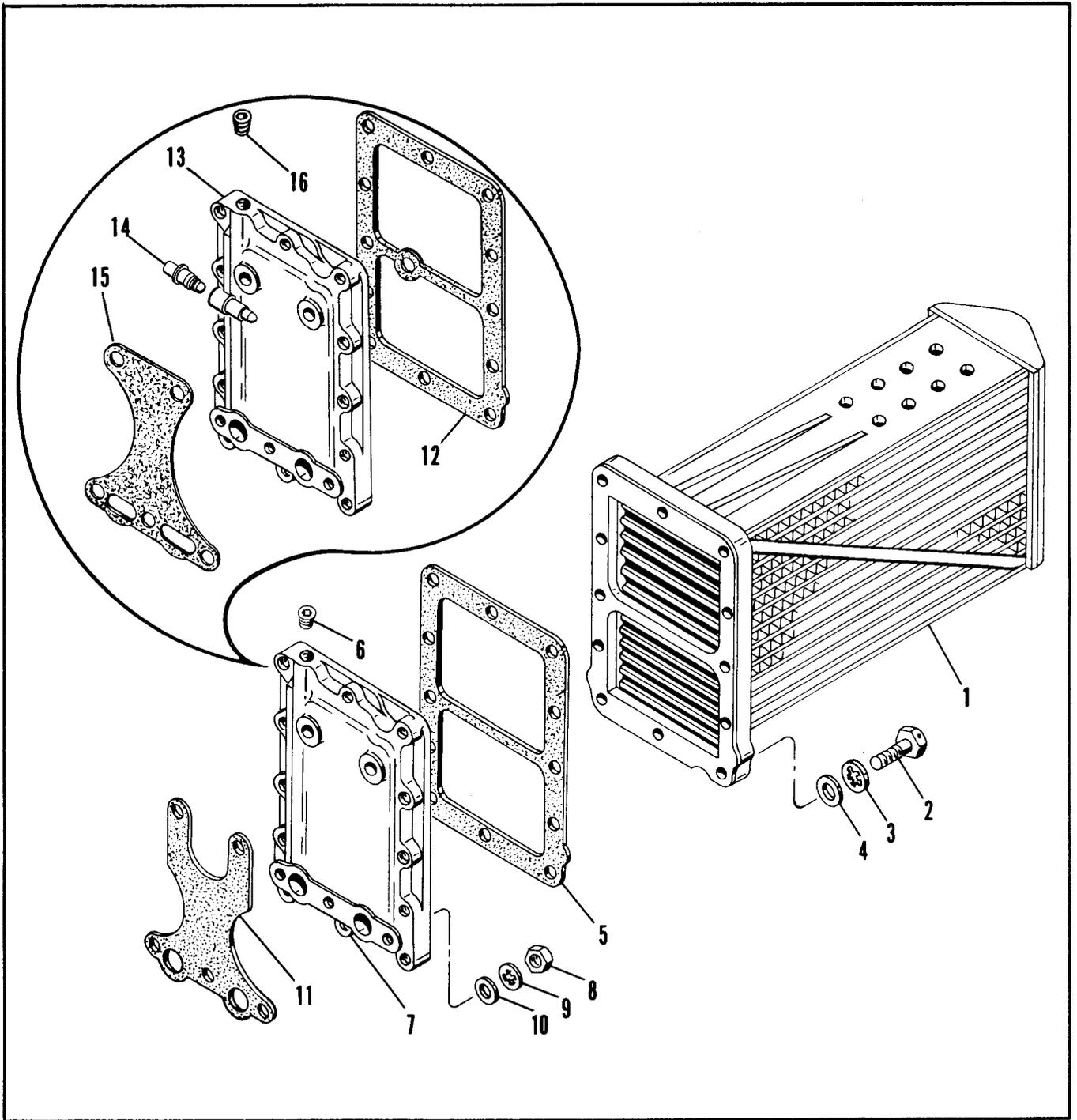

FIGURE 36. OIL COOLER

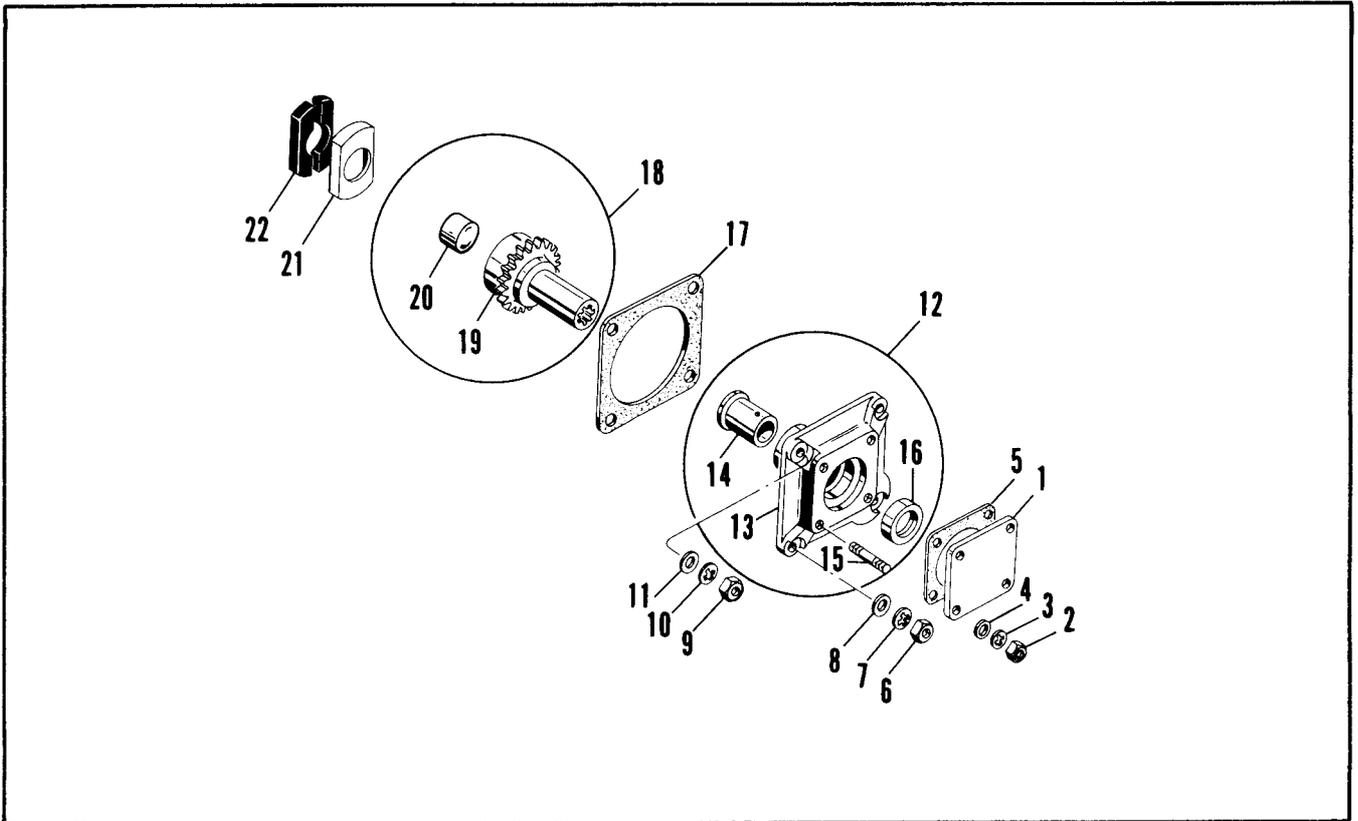

FIGURE 37. MAGNETO AND ACCESSORY DRIVES
MODELS O-470-A, B, E, G, J, K, L, M, P, R, S

FIG. & INDEX	PART NUMBER	DESCRIPTION	QUANTITY PER ASSEMBLY											
			A	B	E	G	J	K	L	M	P	R	S	
37- 1	633068	Cover, Accessory Drive	2	2	2	2	2	2	2	2	2	2	2	2
		ATTACHING PARTS												
- 2	2437	Nut, Plain, Hex	8	8	8	8	8	8	8	8	8	8	8	8
- 3	MS35338-44	Washer, Lock	8	8	8	8	8	8	8	8	8	8	8	8
- 4	2472	Washer, Plain	8	8	8	8	8	8	8	8	8	8	8	8
		* * * *												
- 5	MS9134-01	& Gasket, Cover	2	2	2	2	2	2	2	2	2	2	2	2
- 6	2439	Nut, Plain, Hex	6	6	6	6	6	6	6	6	6	6	6	6
- 7	MS35338-45	Washer, Lock	6	6	6	6	6	6	6	6	6	6	6	6
- 8	2473	Washer, Plain	6	6	6	6	6	6	6	6	6	6	6	6
- 9	2441	Nut, Plain, Hex	2	2	2	2	2	2	2	2	2	2	2	2
-10	MS35338-46	Washer, Lock	2	2	2	2	2	2	2	2	2	2	2	2
-11	401507	Washer, Plain	2	2	2	2	2	2	2	2	2	2	2	2
-12	534861A1	Adapter Assembly, Magneto & Accessory Drive	2	2	2	2	2	2	2	2	2	2	2	2
-13	No Number	. Adapter, Magneto and Accessory Drive	ns	ns	ns	ns	ns	ns	ns	ns	ns	ns	ns	ns
-14	534742	. Bushing, Adapter	1	1	1	1	1	1	1	1	1	1	1	1
-15	401852	† . Stud, 1/4 X 1-13/32 Inch Long	4	4	4	4	4	4	4	4	4	4	4	4
-16	25102	& . Seal, Oil, Adapter	1	1	1	1	1	1	1	1	1	1	1	1
-17	534863	& Gasket, Adapter	2	2	2	2	2	2	2	2	2	2	2	2
-18	629076	Gear Assembly, Magneto & Accessory Drive	2	2	2	2	2	2	2	2	2	2	2	2
-19	No Number	. Gear, Magneto & Accessory Drive	ns	ns	ns	ns	ns	ns	ns	ns	ns	ns	ns	ns
-20	629077	. Sleeve, Gear	1	1	1	1	1	1	1	1	1	1	1	1
-21	531178	Retainer, Magneto Drive Coupling	2	2	2	2	2	2	2	2	2	2	2	2
-22	638172	Coupling, Magneto	4	4	4	4	4	4	4	4	4	4	4	4

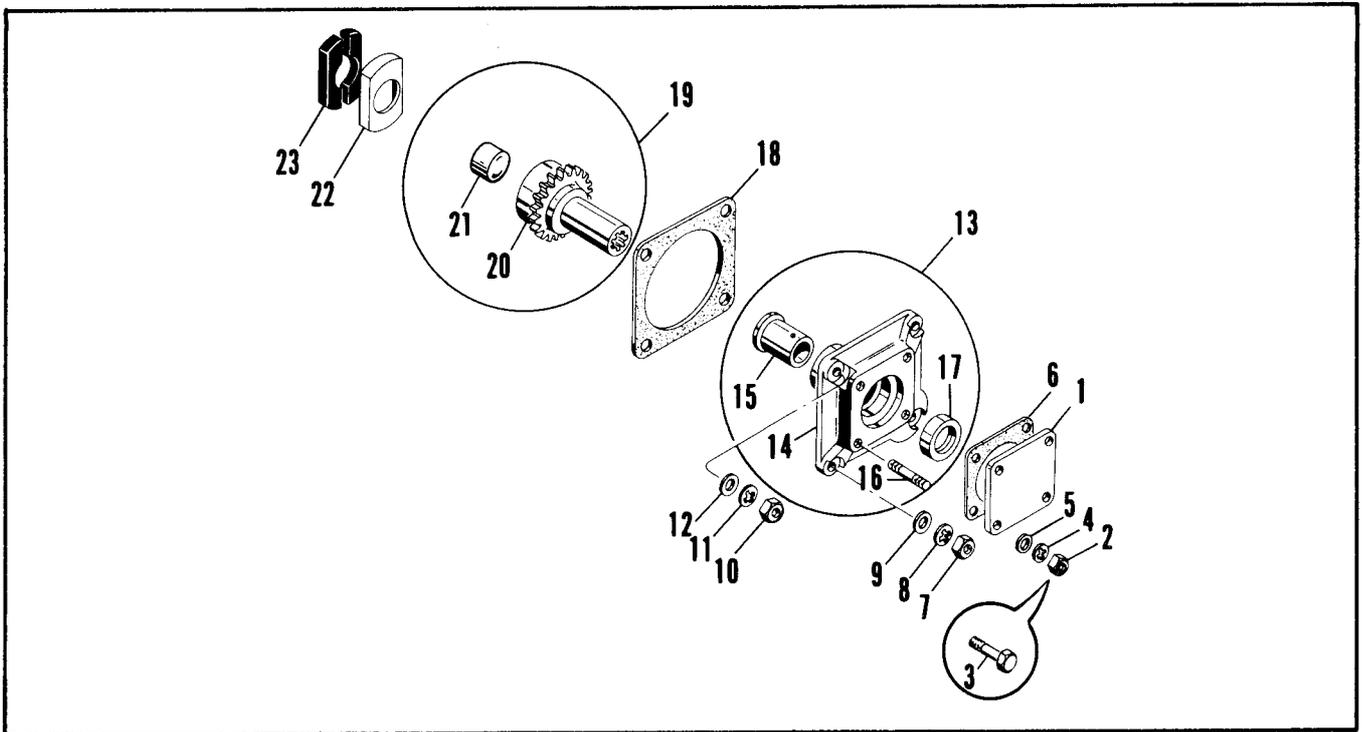

FIGURE 38. MAGNETO AND ACCESSORY DRIVE
 MODELS 10-470-C, D, E, F, G, H, J, K, L, M, N, P, R, S, U, V

FIG. & INDEX	PART NUMBER	DESCRIPTION	QUANTITY PER ASSEMBLY															
			C	D	E	F	G	H	J	K	L	M	N	P	R	S	U	V
38- 1	633068	Cover, Accessory Drive	2	2	2	2	2	2	2	2	2	2	2	2	2	2	2	2
		ATTACHING PARTS																
- 2	2437	Nut, Plain, Hex	8	8	8	8	8	8	8	8	4	8	8	8	8	8	8	
- 3	537629	Bolt, 1/4 X 11/16 Inch Long									4							
- 4	MS35338-44	Washer, Lock	8	8	8	8	8	8	8	8	8	8	8	8	8	8	8	
- 5	2472	Washer, Plain	8	8	8	8	8	8	8	8	8	8	8	8	8	8	8	
		* * * *																
- 6	MS9134-01	& Gasket, Cover	2	2	2	2	2	2	2	2	2	2	2	2	2	2	2	
- 7	2439	Nut, Plain, Hex	6	6	6	6	6	6	6	6	6	6	6	6	6	6	6	
- 8	MS35338-45	Washer, Lock	6	6	6	6	6	6	6	6	6	4	6	6	6	6	6	
- 9	2473	Washer, Plain	6	6	6	6	6	6	6	6	6	4	6	6	6	6	6	
-10	2441	Nut, Plain, Hex	2	2	2	2	2	2	2	2	2	2	2	2	2	2	2	
-11	MS35338-46	Washer, Lock	2	2	2	2	2	2	2	2	2	2	2	2	2	2	2	
-12	401507	Washer, Plain	2	2	2	2	2	2	2	2	2	2	2	2	2	2	2	
-13	628581	Adapter Assembly, Magneto & Accessory Drive, 2-4-6 Side										1						
-13	534861	Adapter Assembly, Magneto & Accessory Drive	2	2	2	2	2	2	2	2	1	2	2	2	2	2	2	
-14	No Number	. Adapter, Magneto and Accessory Drive	ns	ns	ns	ns	ns	ns	ns	ns	ns	ns	ns	ns	ns	ns	ns	
-15	534742	. Bushing, Adapter	1	1	1	1	1	1	1	1	1	1	1	1	1	1	1	
-16	25008	† . Stud, 1/4 X 1-13/32 Inch Long	4	4	4	4	4	4	4	4	4	4	4	4	4	4	4	
-17	25102	& . Seal, Oil, Adapter	1	1	1	1	1	1	1	1	1	1	1	1	1	1	1	
-18	534863	& Gasket, Adapter	2	2	2	2	2	2	2	2	2	2	2	2	2	2	2	
-19	629076	Gear Assembly, Magneto & Accessory Drive	2	2	2	2	2	2	2	2	2	2	2	2	2	2	2	
-20	No Number	. Gear, Magneto & Accessory Drive	ns	ns	ns	ns	ns	ns	ns	ns	ns	ns	ns	ns	ns	ns	ns	
-21	629077	. Sleeve, Gear	1	1	1	1	1	1	1	1	1	1	1	1	1	1	1	
-22	531178	Retainer, Magneto Drive Coupling	2	2	2	2	2	2	2	2	2	2	2	2	2	2	2	
-23	638172	Coupling, Magneto	4	4	4	4	4	4	4	4	4	4	4	4	4	4	4	

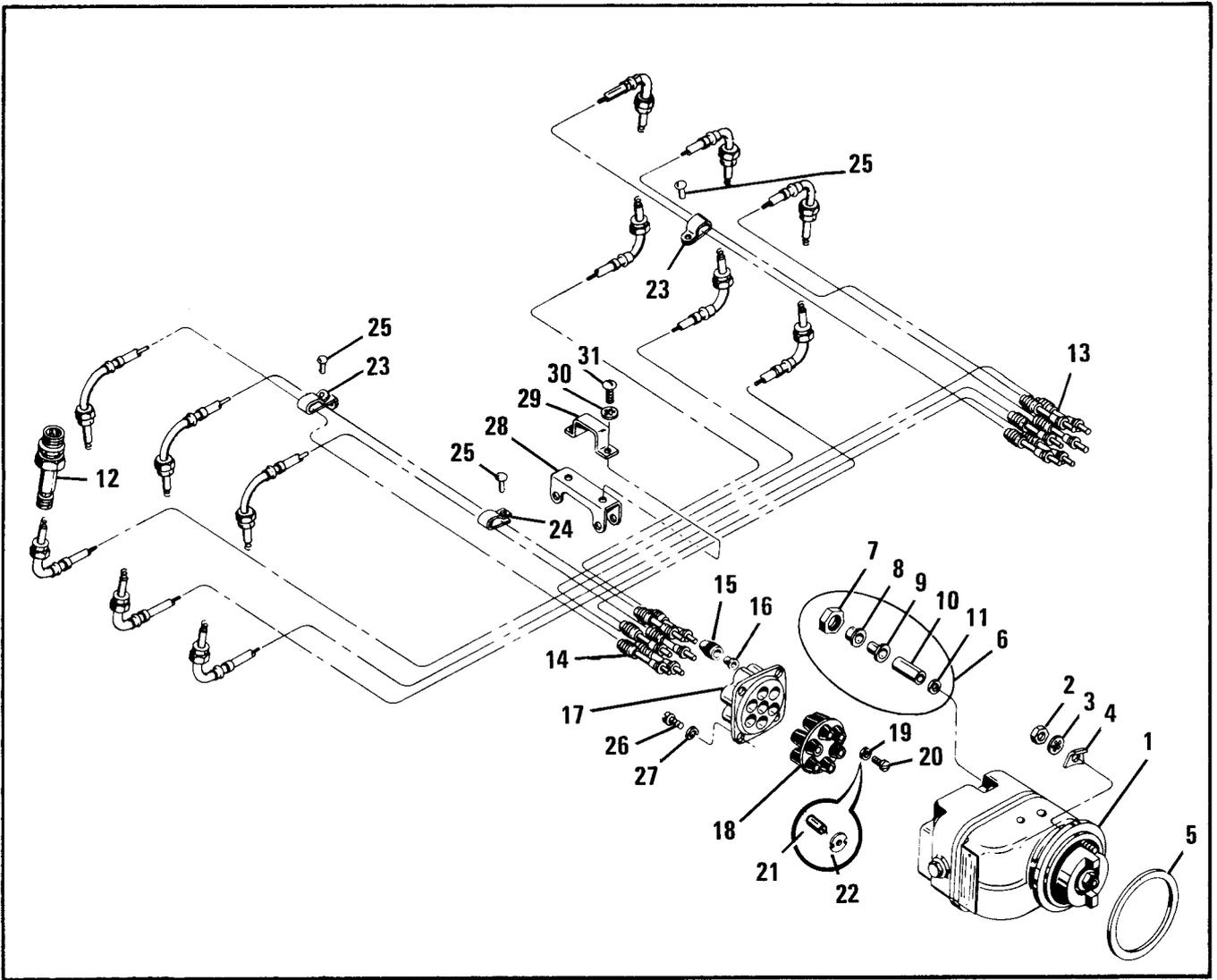

FIGURE 39. IGNITION SYSTEM
 MODELS O-470-A, B, E, G, J, K, L, M, P, R

FIG. & INDEX	PART NUMBER	DESCRIPTION	QUANTITY PER ASSEMBLY											
			A	B	E	G	J	K	L	M	P	R		
39- 1	631237	@ Magneto Assembly	2	2	2	2	2	2	2	2	2	2	2	2
		ATTACHING PARTS												
- 2	2439	Nut, Hex	4	4	4	4	4	4	4	4	4	4	4	4
- 3	MS35338-45	Washer, Lock	4	4	4	4	4	4	4	4	4	4	4	4
- 4	535847	Washer, Magneto Holding	4	4	4	4	4	4	4	4	4	4	4	4
		* * * *												
- 5	534750	& Gasket, Magneto	2	2	2	2	2	2	2	2	2	2	2	2
- 6	352024	Kit, Ground Terminal	2	2	2	2	2	2	2	2	2	2	2	2
- 7	25318	. Nut, Coupling	1	1	1	1	1	1	1	1	1	1	1	1
- 8	25317	. Ferrule, Ground Wire, Outer	1	1	1	1	1	1	1	1	1	1	1	1
- 9	25316	. Ferrule, Ground Wire, Inner	1	1	1	1	1	1	1	1	1	1	1	1
-10	530455	. Sleeve, Insulating	1	1	1	1	1	1	1	1	1	1	1	1
-11	25314	. Washer, Plain	1	1	1	1	1	1	1	1	1	1	1	1
-12	630378	Spark Plug, 18 mm	12		12		12							
-12	539433	Spark Plug, 18 mm						12	12					12
-12	626026	Spark Plug, 18 mm		12									12	
-12	627643	Spark Plug, 18 mm				12								
-12	627978	Spark Plug, 18 mm									12			

FIG. & INDEX	PART NUMBER	DESCRIPTION	QUANTITY PER ASSEMBLY																	
			A	B	E	G	J	K	L	M	P	R								
39-13	535468	@ ∞ * Harness Assembly, Shielded Ignition, Left Magneto	1																	
-14	535469	@ ∞ * Harness Assembly, Shielded Ignition, Right Magneto	1																	
-13	625298	@ ∞ ** Harness Assembly, Shielded Ignition, Left Magneto		1	1		1	1	1											
-14	625299	@ ∞ ** Harness Assembly, Shielded Ignition, Right Magneto		1	1		1	1	1											
-13	625982	@ ∞ * Harness Assembly, Shielded Ignition, Left Magneto				1											1			
-14	625983	@ ∞ * Harness Assembly, Shielded Ignition, Right Magneto				1												1		
-13	627039	@ ∞ ** Harness Assembly, Shielded Ignition, Left Magneto														1				
-14	627038	@ ∞ ** Harness Assembly, Shielded Ignition, Right Magneto													1					
-13	633113	@ ∞ ** Harness Assembly, Shielded Ignition, Left Magneto																		1
-14	633114	@ ∞ ** Harness Assembly, Shielded Ignition, Right Magneto																		1
-15	25302	*** . Nut	12	12	12	12	12	12	12	12	12	12	12	12	12	12	12	12	12	12
-16	20087	*** . Ferrule	12	12	12	12	12	12	12	12	12	12	12	12	12	12	12	12	12	12
-17	25312	. Plate, Cable Outlet	2	2	2	2	2	2	2	2	2	2	2	2	2	2	2	2	2	2
-18	36219	. Grommet, Plate	2	2	2	2	2	2	2	2	2	2	2	2	2	2	2	2	2	2
-19	25388	. Washer, Cable Contact	12																	
-20	25387	. Screw, Cable Contact	12																	
-21	627001	. Sleeve, Distributor Cable		12	12	12	12	12	12	12	12	12	12	12	12	12	12	12	12	12
-22	627002	. Washer, Magneto Block		12	12	12	12	12	12	12	12	12	12	12	12	12	12	12	12	12
-23	535042	. Clamp, Ignition Leads	2																	
-23	625965	. Clamp, Ignition Leads															2			
-24	625965-1	. Clamp, Ignition Leads															1			
-25	21264	. Rivet	2														3			
-26	25320	Screw, Machine,	8	8	8	8	8	8	8	8	8	8	8	8	8	8	8	8	8	8
-27	25321	Washer, Lock	8	8	8	8	8	8	8	8	8	8	8	8	8	8	8	8	8	8
	539140	Bracket Assembly, Ignition Harness		1	1	1	1	1	1	1	1	1	1	1	1	1	1	1	1	1
	535559	Bracket Assembly, Ignition Harness		1																
-28	630093	. Bracket and Nut Assembly, Ignition Harness		1	1	1	1	1	1	1	1	1	1	1	1	1	1	1	1	1
-28	538480	. Bracket, Ignition Harness		1																
-29	535557	. Clip, Bracket	1	1	1	1	1	1	1	1	1	1	1	1	1	1	1	1	1	1
-30	20527	. Washer, Lock	2	2	2	2	2	2	2	2	2	2	2	2	2	2	2	2	2	2
-31	AN515-8-6	. Screw, Machine	2	2	2	2	2	2	2	2	2	2	2	2	2	2	2	2	2	2

∞ See Figure No. 44 for Individual Cable Assemblies

* See Figure No. 45-1 for Detail Parts of Ignition Cable Spark Plug End.

** See Figure No. 46-1 for Detail Parts of Ignition Cable Spark Plug End.

*** Applicable to all cable assemblies.

@ See Section VI For Specification Applications.

FIG. & INDEX	PART NUMBER	DESCRIPTION	QUANTITY PER ASSEMBLY																		
			A	B	E	G	J	K	L	M	P	R	S								
40-16	633579	* . Cable Assembly, No. 5 Lower, 50 Inches Long																			1
-17	633580	* . Cable Assembly, No. 2 Upper, 21 Inches Long																			1
-18	633580	* . Cable Assembly, No. 4 Upper, 18 Inches Long																			1
-19	633580	* . Cable Assembly, No. 6 Upper, 25 Inches Long																			1
-20	633586	. Spring																			1
-21	633585	. Screw																			1
-22	633584	. Sleeve Insulating																			1
-23	633583	. Ferrule																			1
-24	633582	. Washer																			1
-25	633581 **	. Nut, Magneto End																			1
-26	636692	. Clamp Assembly																			2
-27	632105	. Screw																			2
-28	629837	. Nut																			2
-29	636922	. Clamp Assembly																			1
-30	626919	. . Clamp																			1
-31	636687	. . Screw																			1
-32	633927	. . Nut																			1
-33	AN501-10-8	. Screw																			1
-34	22910	. Washer, Lock																			1
-35	MS20365-1032A	. Nut, Elastic Stop																			1
-36	633926	. Ty-Rap																			10
-37	633925	. Clamp																			12
-38	633593	. Nut																			1
-39	633589	. Ferrule																			1
-40	633583	. Ferrule																			1
-41	633590	. Spring																			1
-42	633592	. Washer																			1
-43	633591	. Sleeve																			1
-44	633586	. Spring																			1
-45	633585	. Screw																			1

* *Service leads furnished in two lengths only and terminated at both ends.*

633580 for leads up to 28 Inches Long

633579 for leads up to 50 Inches Long

Disassemble lead assemblies at magneto end. Cut lead to length specified and reassemble per instructions in overhaul manual or Slick Electro Form No. 1007.

** *Order dash number depending on lead required, i.e., 633581T4 for No. 4 upper lead or 633581B6 for No. 6 lower lead.*

@ *See Section VI For Specification Applications.*

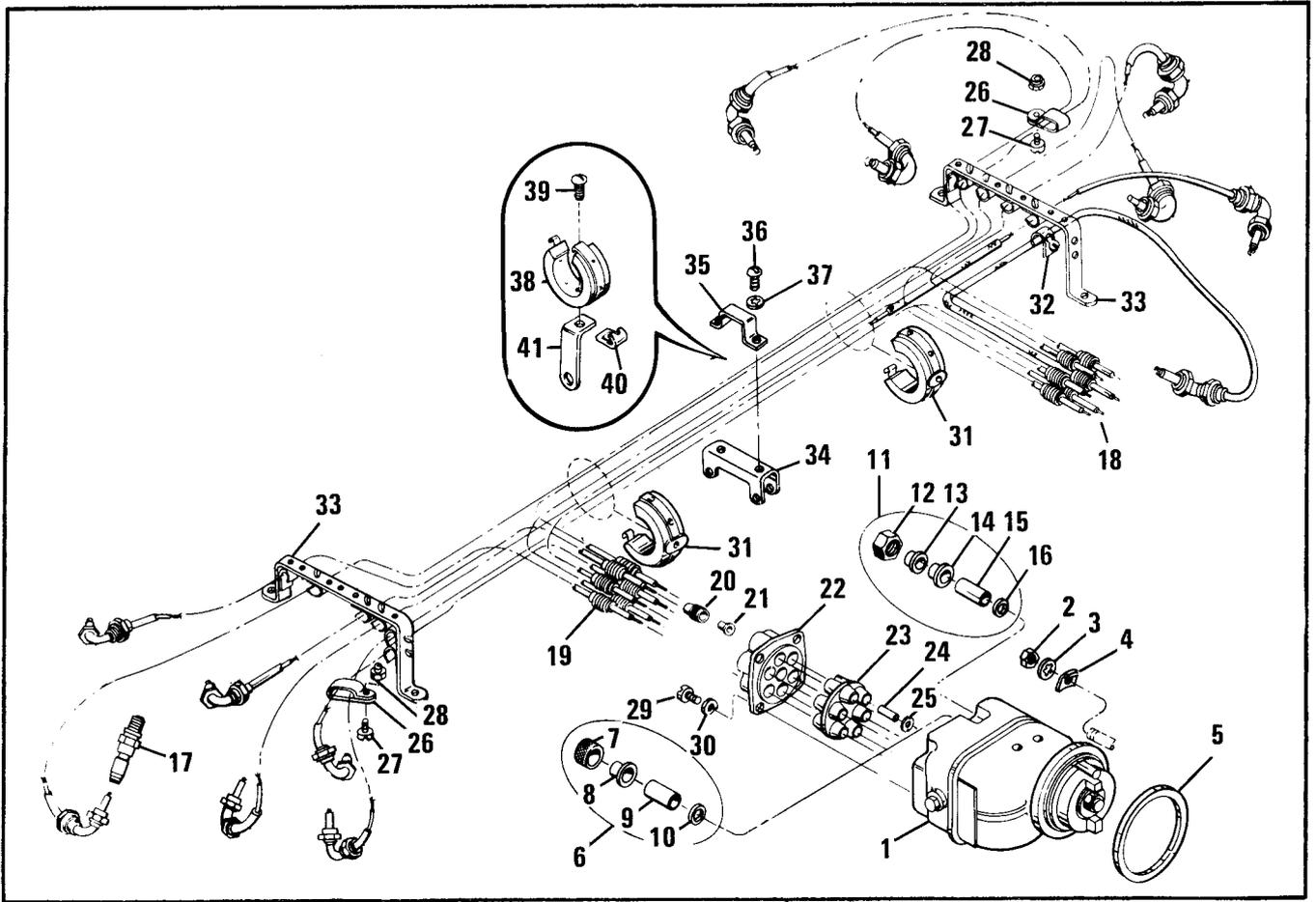

FIGURE 41. IGNITION SYSTEM
 MODELS IO-470-C, D, E, F, G, H, L, M, N, P, R

FIG. & INDEX	PART NUMBER	DESCRIPTION	QUANTITY PER ASSEMBLY															
			C	D	E	F	G	H	J	K	L	M	N	P	R	S	U	V
41- 1	631237	@ Magneto Assembly	2	2	2	2	2	2							2	2		
- 1	628472	@ Magneto Assembly, Left Hand												1	1	1		
- 1	628473	@ Magneto Assembly, Right Hand												1	1	1		
		ATTACHING PARTS																
- 2	2439	Nut, Hex	4	4	4	4	4	4					4	4	4	4	4	
- 3	MS35338-45	Washer, Lock	4	4	4	4	4	4					4	4	4	4	4	
- 4	535847	Washer, Magneto Holding	4	4	4	4	4	4					4	4	4	4	4	
		* * * *																
- 5	534750	& Gasket, Magneto	2	2	2	2	2	2					2	2	2	2	2	
- 6	628739	Kit, Ground Terminal, Left Magneto												1	1	1		
- 7	629007	. Nut, Coupling												1	1	1		
- 8	629008	. Bushing, Shouldered												1	1	1		
- 9	629009	. Bushing, Insulating												1	1	1		
-10	629010	. Washer, Plain												1	1	1		
	628740	Kit, Ground Terminal and Right Magneto												2	2	2		
- 7	629011	. Nut, Coupling												1	1	1		
- 8	629008	. Bushing, Shouldered												1	1	1		
- 9	629009	. Bushing, Insulating												1	1	1		
-10	629010	. Washer, Plain												1	1	1		
-11	352024	Kit, Ground Terminal and Right Magneto	2	2	2	2	2	2								2	2	
-12	25318	. Nut, Coupling	1	1	1	1	1	1								1	1	
-13	25317	. Ferrule, Ground Wire, Outer	1	1	1	1	1	1								1	1	
-14	25316	. Ferrule, Ground Wire, Inner	1	1	1	1	1	1								1	1	

FIG. & INDEX	PART NUMBER	DESCRIPTION	QUANTITY PER ASSEMBLY															
			C	D	E	F	G	H	J	K	L	M	N	P	R	S	U	V
41-15	530455	. Sleeve, Insulating	1	1	1	1	1	1							1	1		
-16	25314	. Washer, Plain	1	1	1	1	1	1							1	1		
-17	632516	Spark Plug, 18 mm				12		12										
-17	627449	Spark Plug, 18 mm	12															
-17	627450	Spark Plug, 18 mm						12							12	12		
-17	634675	Spark Plug,		12	12						12	12	12					
-18	627805	@ ∞ * Harness Assembly, Shielded Ignition, Left Magneto		1	1	1	1	1			1	1	1	1	1			
-19	627804	@ ∞ * Harness Assembly, Shielded Ignition, Right Magneto		1	1	1	1	1			1	1	1	1	1			
-18	627863	@ ∞ * Harness Assembly, Shielded Ignition, Left Magneto	1															
-19	627862	@ ∞ * Harness Assembly, Shielded Ignition Right Magneto	1															
-20	25302	** . Nut	12	12	12	12	12	12			12	12	12	12	12			
-21	20087	** . Ferrule	12	12	12	12	12	12			12	12	12	12	12			
-22	25312	. Plate, Cable Outlet	2	2	2	2	2	2			2	2	2	2	2			
-23	36219	. Grommet, Plate	2	2	2	2	2	2			2	2	2	2	2			
-24	627001	. Sleeve, Distributor Cable	12	12	12	12	12	12			12	12	12	12	12			
-25	627002	. Washer, Magneto Block	12	12	12	12	12	12			12	12	12	12	12			
-26	627921	. Clamp, Ignition Harness	2	2	2	2	2	2			2	2	2	2	2			
		ATTACHING PARTS																
-27	627759	. Bolt	2	2	2	2	2	2			2	2	2	2	2			
-28	627756	. Nut, Stop	2	2	2	2	2	2			2	2	2	2	2			
		* * * *																
-29	25320	Screw, Machine	8	8	8	8	8	8			8	8	8	8	8			
-30	25321	Washer, Lock	8	8	8	8	8	8			8	8	8	8	8			
-31	628271	Band, Clamp	2	2	2	2	2	2			2	2	2	2	2			
-32	626577-2R	Clamp, Ignition Cable	12	12	12	12	12	12			12	12	12	12	12			
-33	626486	Bracket, Fuel Discharge Tube	2	2	2	2	2	2			2	2	2	2	2			
	539140	Bracket Assembly, Ignition Harness	1	1	1	1	1	1							1	1		
-34	630093	. Bracket and Nut Assembly, Ignition Harness	1	1	1	1	1	1							1	1		
-35	535557	. Clip, Bracket	1	1	1	1	1	1							1	1		
		ATTACHING PARTS																
-36	AN515-8-6	. Screw, Machine	2	2	2	2	2	2							2	2		
-37	20527	. Washer, Lock	2	2	2	2	2	2							2	2		
		* * * *																
-38	628271	Band, Clamp			2						1	1	1					
		ATTACHING PARTS																
-39	AN526-1024-1	Screw, Sheet Metal									1	1	1					
-40	537911	Nut, Speed									1	1	1					
		* * * *																
-41	626524	Bracket, Ignition Harness									1	1	1					

∞ See Figure No. 44 for Individual Cable Assemblies

* See Figure No. 47-1 for Detail Parts of Ignition Cable Spark Plug End.

** Applicable to all cable assemblies.

@ See Section VI For Specification Applications.

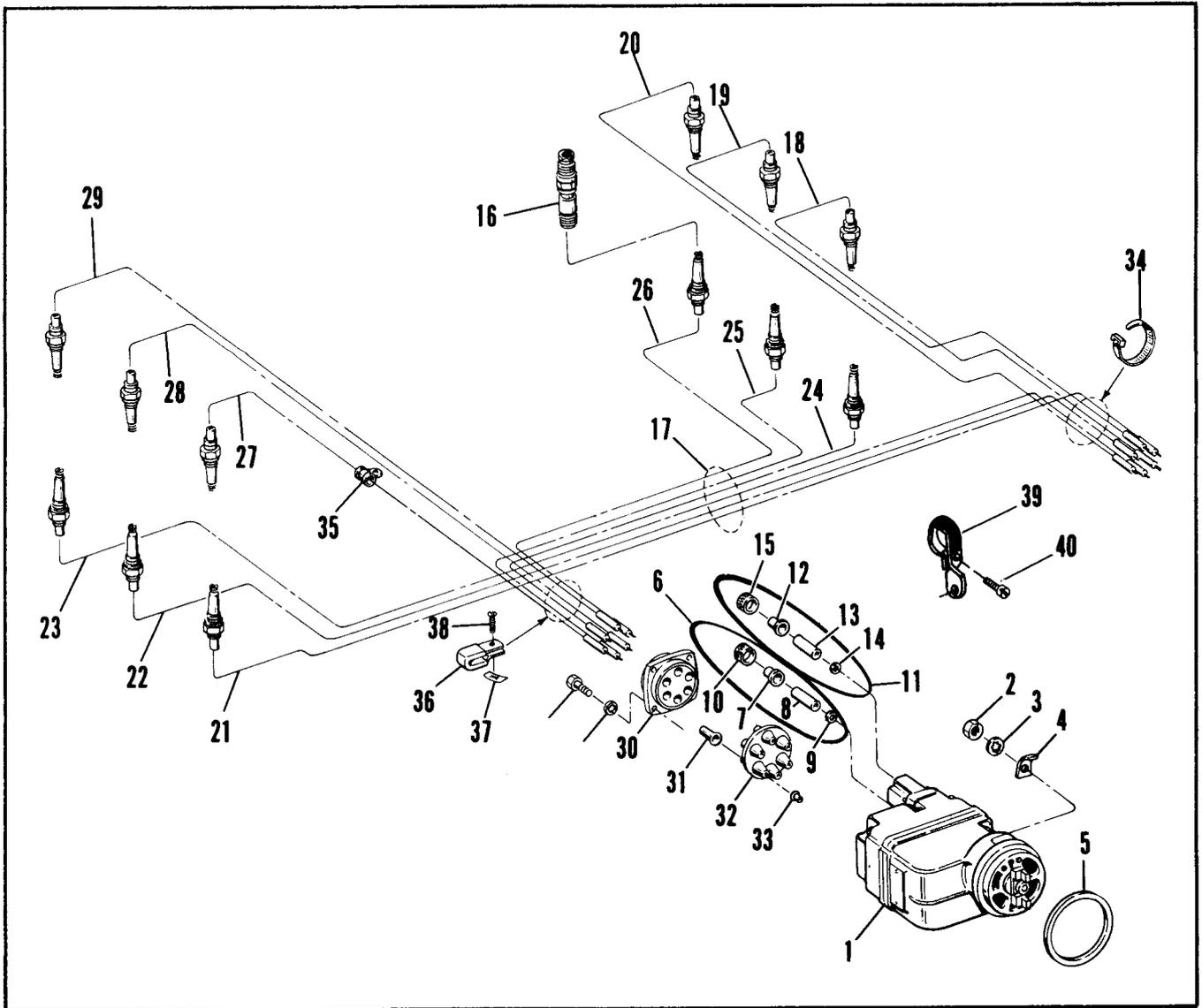

FIGURE 42. IGNITION SYSTEM
MODELS 10-470-S, U, V

FIG. & INDEX	PART NUMBER	DESCRIPTION	QUANTITY PER ASSEMBLY																		
			C	D	E	F	G	H	J	K	L	M	N	P	R	S	U	V			
42- 1	628472	@ Magneto Assembly, Left Hand																1	1	1	
	628473	@ Magneto Assembly, Right Hand																	1	1	1
		ATTACHING PARTS																			
- 2	2439	Nut, Hex																4	4	4	
- 3	MS35338-45	Washer, Lock																4	4	4	
- 4	535847	Washer, Magneto Holding																4	4	4	
		* * * *																			
- 5	534750	& Gasket, Magneto																2	2	2	
- 6	628739	Kit, Ground Terminal, Left Magneto																1	1	1	
- 7	629008	. Bushing, Shouldered																1	1	1	
- 8	629009	. Bushing, Insulating																1	1	1	
- 9	629010	. Washer, Plain																1	1	1	
-10	629007	. Nut, Coupling																1	1	1	
-11	628740	Kit, Ground Terminal, L & R Magneto																1	1	1	
-12	629008	. Bushing, Shouldered																1	1	1	
-13	629009	. Bushing, Insulating																1	1	1	

FIG. & INDEX	PART NUMBER	DESCRIPTION	QUANTITY PER ASSEMBLY																
			C	D	E	F	G	H	J	K	L	M	N	P	R	S	U	V	
42-14	629010	. Washer, Plain															1	1	1
-15	629011	. Nut, Coupling															1	1	1
-16	634675	Spark Plug, 18 mm															12	12	12
-17	636954	@ * Harness Assembly, Complete Shielded Ign.															1	1	1
	No Number	. Harness Assembly, Right Magneto															ns	ns	ns
-18	637409-48	** . . Cable Assembly, No. 1, Upper 15.25 Inch Long															1	1	1
-19	637409-48	** . . Cable Assembly, No. 3, Upper 20.06 Inch Long															1	1	1
-20	637409-48	** . . Cable Assembly, No. 5, Upper 28.06 Inch Long															1	1	1
-21	637409-48	** . . Cable Assembly, No. 2, Lower 39.06 Inch Long															1	1	1
-22	637409-48	** . . Cable Assembly, No. 4, Lower 35.69 Inch Long															1	1	1
-23	637409-48	** . . Cable Assembly, No. 6, Lower 42.06 Inch Long															ns	ns	ns
	No Number	. Harness Assembly, Left Magneto															1	1	1
-24	647409-48	** . . Cable Assembly, No. 1, Lower 35.69 Inch Long															1	1	1
-25	637409-48	** . . Cable Assembly, No. 3, Lower 40.56 Inch Long															1	1	1
-26	647409-48	** . . Cable Assembly, No. 5, Lower 47.56 Inch Long															1	1	1
-27	647409-48	** . . Cable Assembly, No. 2, Upper 20.00 Inch Long															1	1	1
-28	637409-48	** . . Cable Assembly, No. 4, Upper 17.19 Inch Long															1	1	1
-29	637409-48	** . . Cable Assembly, No. 6, Upper 23.06 Inch Long															1	1	1
-30	633009	*** . . Plate, Cable Outlet															1	1	1
-31	629498	*** . . Ferrule, Cable															6	6	6
-32	629496	*** . . Grommet, Plate															1	1	1
-33	629495	*** . . Eyelet, Cable Contact															6	6	6
-34	629494	. Strap, Ignition Harness															10	10	10
-35	632106	. Clamp, Ignition Cable															12	12	12
-36	631739	. Clamp, Ignition Harness															2	2	2
-37	629837	. Nut, Speed															2	2	2
-38	632105	. Screw															2	2	2
-39	635363	. Clamp															1	1	1
-40	635360	. Screw															1	1	1
-41	25320	Screw															8	8	8
-42	25321	Washer, Lock															8	8	8

* See Figure No. 48-9 for Detail Parts of Ignition Cable Spark Plug End.

** Service leads furnished in two (2) lengths only.
637409-48 Cable Assembly for leads up to 48" long.
637409-72 Cable Assembly for leads up to 72" long.

*** Applicable to all cables assemblies.
Service sleeves - Use Thomas and Betts crimping tool No. WT-217.

@ See Section VI For Specification Applications.

ENGINE MODEL	HARNESS ASSY. PART NUMBER	CABLE ASSY. PART NO.	UPPER PLUG LEAD LENGTHS						LOWER PLUG LEAD LENGTHS											
			NO. 1	NO. 2	NO. 3	NO. 4	NO. 5	NO. 6	NO. 1	NO. 2	NO. 3	NO. 4	NO. 5	NO. 6						
A	Left Magneto 535468	533796		19.44		17.94			21.19			32.44			33.69			39.69		
	Right Magneto 535469	533796	16.19		19.44			22.69							33.69		32.44			39.69
B, E, J, K, L	Left Magneto 625298	626359		19.44		17.44			21.19			33.44			33.69				39.69	
	Right Magneto 625299	626359	16.19		19.44			22.69							34.69		32.44			39.69
G, P	Left Magneto 625983	626831				18.94						39.65			33.31				39.31	
	Right Magneto 625983	626832		19.44					21.19						34.31		33.06			39.31
M	Left Magneto 627039	628747										33.44							39.69	
	Right Magneto 627038	627040		19.44		17.94			21.19										39.69	
R	Left Magneto 633113	626359		19.44		17.94			21.19			33.44			33.69				39.69	
	Right Magneto 633114	626359	16.19		19.44			22.69							34.69		32.44			39.69

ENGINE MODEL	HARNESS ASSY. PART NUMBER	CABLE ASSY. PART NO.	UPPER PLUG LEAD LENGTHS						LOWER PLUG LEAD LENGTHS											
			NO. 1	NO. 2	NO. 3	NO. 4	NO. 5	NO. 6	NO. 1	NO. 2	NO. 3	NO. 4	NO. 5	NO. 6						
C	Left Magneto 627863	626831										36.94			37.19				41.19	
	Right Magneto 627862	626832		19.44		17.94			21.19											
D, E, F, G, H, L, M, N, P, R	Left Magneto 627805	627040		19.44		18.94			23.19			36.94			37.19				42.19	
	Right Magneto 627804	627040	16.19		19.44			22.69							37.69		35.69			41.69

FIGURE 44. IGNITION CABLE LEAD LENGTHS.

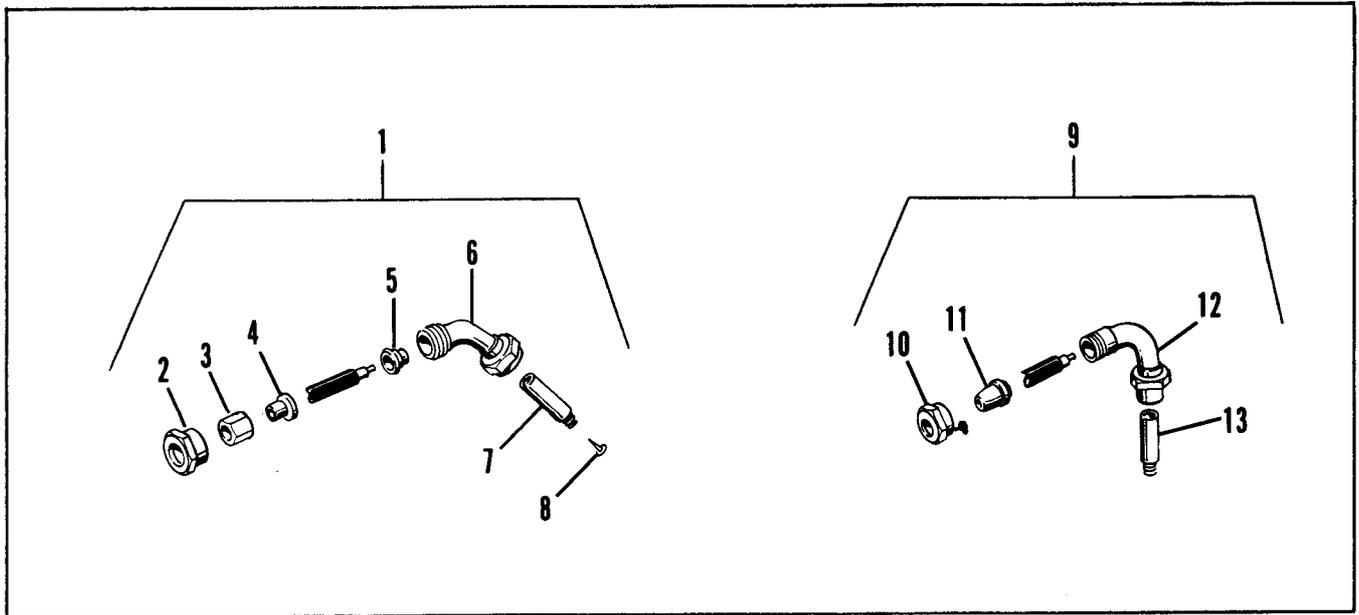

FIGURE 45. IGNITION CABLE, SPARK PLUG END, MODELS O-470-A, G, P.

FIG. & INDEX	PART NUMBER	DESCRIPTION	QUANTITY PER ASSEMBLY											
			A	B	E	G	J	K	L	M	P	R		
45- 1	No Number	Cable Assembly				ns							ns	
- 2	636675	. Nut, Spark Plug End				1							1	
- 3	636676	. Ferrule, CAble, Outer				1							1	
- 4	636677	. Ferrule, Cable, Inner				1							1	
- 5	636678	. Grommet				1							1	
- 6	WE365	. Elbow Assembly (626831 Cable)				1							1	
- 6	WE1017	. Elbow Assembly (626832 Cable)				1							1	
- 7	628986	. Sleeve, Spark Plug Terminal				1							1	
- 8	626718	. Nail				1							1	
- 9	No Number	Cable Assembly	ns											
-10	532148	. Nut, Spark Plug End	1											
-11	532149	. Ferrule, Cable	1											
-12	532151	. Elbow Assembly, Cable	1											
-13	21440	. Sleeve, Spark Plug Terminal	1											

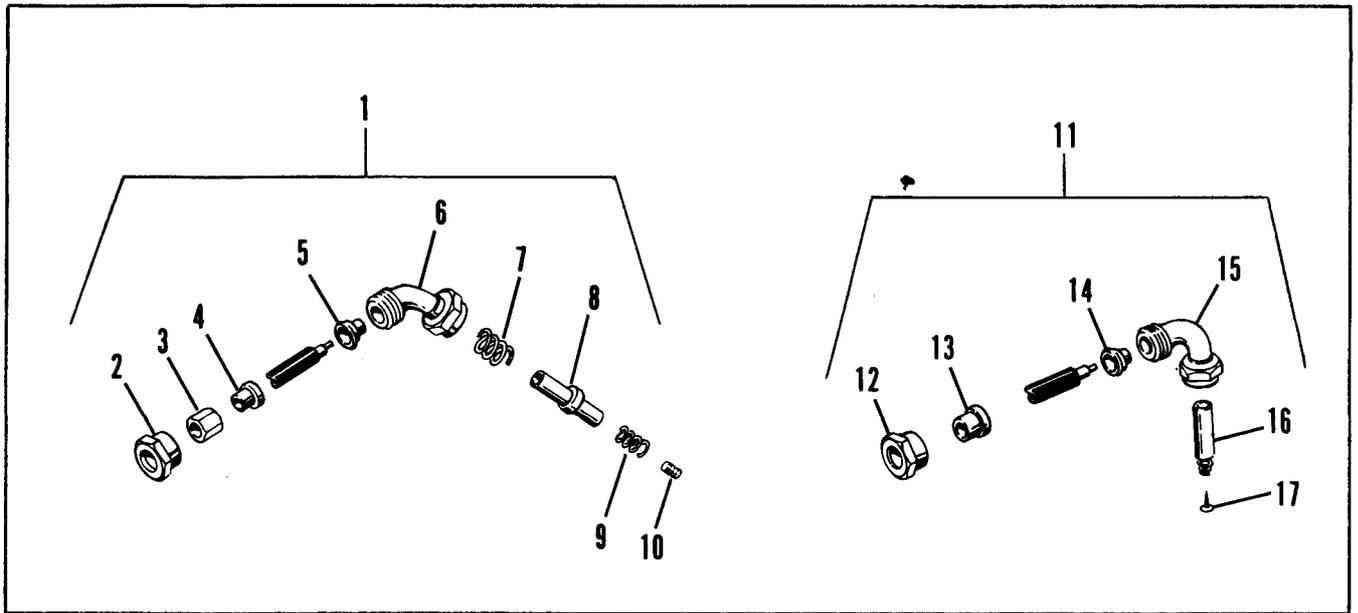

FIGURE 46. IGNITION CABLE, SPARK PLUG END, MODELS O-470-B, E, J, K, L, M, R.

FIG. & INDEX	PART NUMBER	DESCRIPTION	QUANTITY PER ASSEMBLY												
			A	B	E	G	J	K	L	M	P	R			
46- 1	No Number	Cable Assembly									ns				
- 2	636675	. Nut, Spark Plug End													1
- 3	636676	. Ferrule, Cable Outer													1
- 4	636677	. Ferrule, Cable Inner													1
- 5	636678	. Grommet													1
- 6	WE678	. Elbow Assembly													1
- 7	WE626	. Spring, Compression													1
- 8	WE565	. Grommet													1
- 9	626714	. Spring, Terminal													1
-10	626713	. Stud, Terminal Spring													1
-11	No Number	Cable Assembly		ns	ns			ns	ns	ns					ns
-12	636675	. Nut, Spark Plug End		1	1			1	1	1					1
-13	WE502	. Ferrule, Cable		1	1			1	1	1					1
-14	636678	. Grommet		1	1			1	1	1					1
-15	WE1017	. Elbow Assembly		1	1			1	1	1					1
-16	628986	. Sleeve, Spark Plug Terminal		1	1			1	1	1					1
-17	626718	. Nail		1	1			1	1	1					1

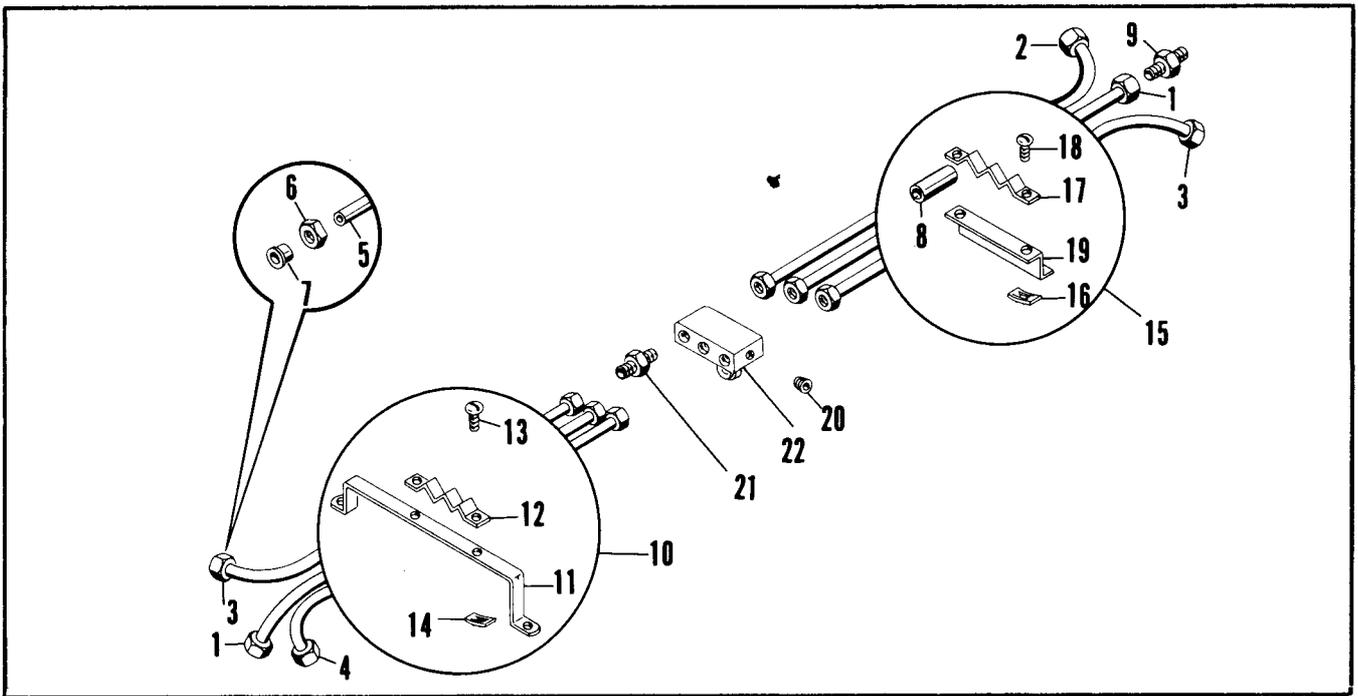

FIGURE 49. PRIMING SYSTEM
MODELS O-470-B, G, M, P

FIG. & INDEX	PART NUMBER	DESCRIPTION	QUANTITY PER ASSEMBLY											
			A	B	E	G	J	K	L	M	P	R		
49-	536486	Priming System Assembly		1		1					1	1		
- 1	532685	. Tube Assembly, Primer, No. 3,4		2		2					2	2		
- 2	532686	. Tube Assembly, Primer, No. 5		1		1					1	1		
- 3	532687	. Tube Assembly, Primer, No. 1,6		2		2					2	2		
- 4	536485	. Tube Assembly, Primer, No. 2		1		1					1	1		
- 5	No Number	. . Tube, Primer		ns		ns					ns	ns		
- 6	AN805-2	. . Nut, Union		2		2					2	2		
- 7	20720	. . Cone, Union		2		2					2	2		
- 8	21512	. . Protector, Primer Tube		1		1					1	1		
- 9	AN4022-1	. Nipple, Priming System Jet Union		6		6					6	6		
-10	532943	. Clamp Assembly, Primer Lines, 2-4-6 Side		1		1					1	1		
-11	532944	. . Bracket, Primer Lines Clamp		1		1					1	1		
-12	532945	. . Clamp, Primer Lines		1		1					1	1		
		ATTACHING PARTS												
-13	AN530-10-6	. . Screw, Tapping		2		2					2	2		
-14	532362	. . Nut, Speed		2		2					2	2		
		* * * *												
-15	532946	. Clamp Assembly, Primer Lines, 1-3-5 Side		1		1					1	1		
-16	532947	. . Bracket, Primer Lines Clamp		1		1					1	1		
-17	532945	. . Clamp, Primer Lines		1		1					1	1		
		ATTACHING PARTS												
-18	AN530-10-6	. . Screw, Tapping		2		2					2	2		
-19	532362	. . Nut, Speed		2		2					2	2		
		* * * *												
-20	2024	Plug, Pipe, 1/8 Inch NPT		1		1					1	1		
-21	AN780-2	Nipple, Union, Primer Distributor		6		6					6	6		
-22	539520	Distributor, Primer		1		1					1	1		

NOTE: When a priming system is required for O-470-A, E, J, K or L Engine, order complete priming system number EQ5880.

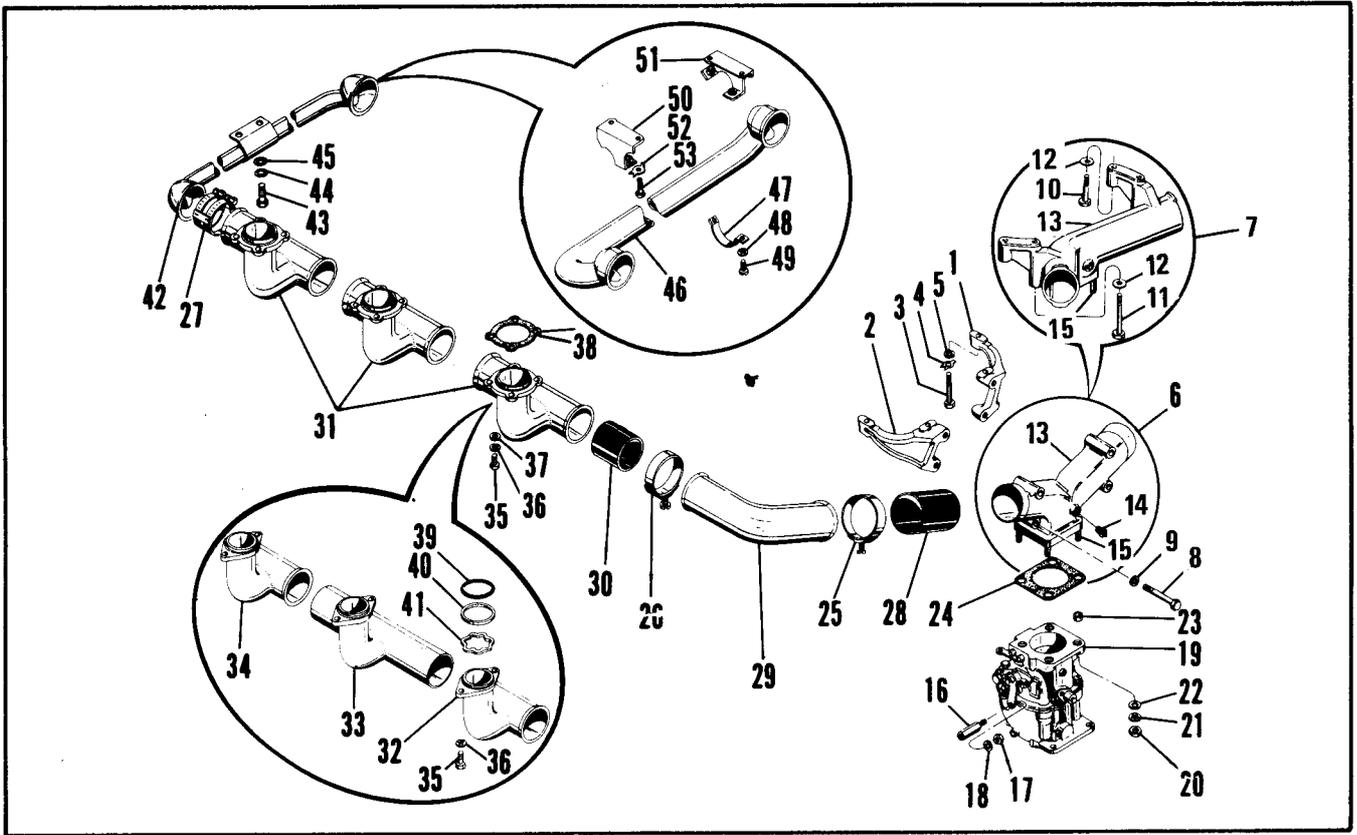

FIGURE 50. INDUCTION SYSTEM
MODELS O-470-A, J, K, L, R, S

FIG. & INDEX	PART NUMBER	DESCRIPTION	QUANTITY PER ASSEMBLY													
			A	B	E	G	J	K	L	M	P	R	S			
50- 1	536036	Bracket, Manifold Riser, Right Side	1				1	1								
- 2	536037	Bracket, Manifold Riser, Left Side	1				1	1								
		ATTACHING PARTS														
- 3	AN75A15	Bolt	4				4	4								
- 4	501868	Washer, Tab	4													
- 5	2473	Washer, Plain	4				4	4								
		* * * *														
- 6	538361A1	Riser Assembly, Manifold	1				1	1								
- 7	627658A1	Riser Assembly, Manifold									1				1	1
		ATTACHING PARTS														
- 8	AN75A26	Bolt	4				4	4								
- 9	2473	Washer, Plain	4				4	4								
-10	538999	Bolt, 5/16 X 3-5/8 Inch Long									2				2	2
-11	AN75A15	Bolt									2				2	2
-12	2473	Washer, Plain									4				4	4
		* * * *														
-13	No Number	. Riser, Manifold	ns				ns	ns	ns					ns		
-14	629518-1H	. Plug, Pipe, 1/8 Inch NPT	1				1	1	1						1	1
-15	401971	† . Stud, 5/16 X 1-5/8 Inch Long	4				4	4	4						4	4
		* * * *														
-16	536432	Extension, Throttle Control	1					1	1	1					1	
		ATTACHING PARTS														
-17	22661	Nut, Hex	1					1	1	1					1	
-18	20522	Washer, Plain	1					1	1	1					1	
		* * * *														

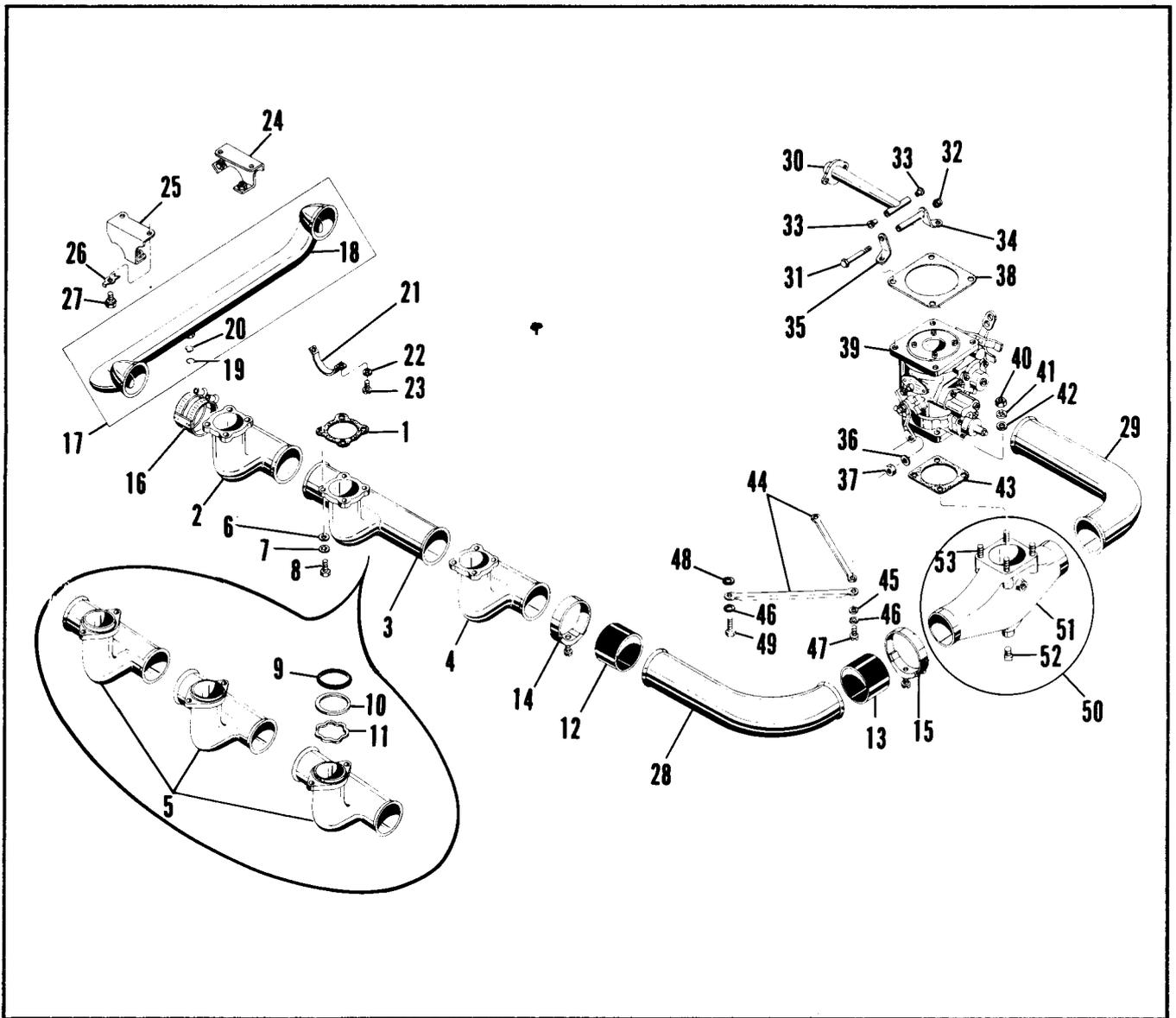

FIGURE 51. INDUCTION SYSTEM
MODELS O-470-B, E, M

FIG. & INDEX	PART NUMBER	DESCRIPTION	QUANTITY PER ASSEMBLY												
			A	B	E	G	J	K	L	M	P	R			
51- 1	536413	& Gasket, Intake Manifolds		6								6			
- 2	537873	Tube Assembly, Intake Manifo.d, No. 1, 5, 6		3								3			
- 3	537875	Tube Assembly, Intake Manifold, No. 3, 4		2								2			
- 4	537874	Tube Assembly, Intake Manifold, No. 2		1								1			
- 5	538554	Tube Assembly, Intake Manifolds				6									
ATTACHING PARTS															
- 6	20522	Washer, Plain, 5/16 Inch		24								24			
- 7	MS35338-44	Washer, Lock		24	12							24			
- 8	24835	Bolt, 1/4 X 7/8 Inch Long		24								24			
- 8	24830	Bolt, 1/4 X 13/16 Inch Long				12									
		* * * * *													
- 9	536740	& Seal, Intake Manifold Tube				6									
-10	534365	Washer, Intake Manifold Tube				6									
-11	534360	Spring, Intake Manifold Tube				6									
-12	539571	& Hose, Intake Manifold		8	8							8			

FIG. & INDEX	PART NUMBER	DESCRIPTION	QUANTITY PER ASSEMBLY												
			A	B	E	G	J	K	L	M	P	R			
51-13	539571	& Hose, Riser-to-Elbow		2								2			
-14	36151J	Clamp, Hose		4	16							8			
-15	631972	Clamp, Hose		4								8			
-16	539487	Clamp Assembly, Hose		2	2							2			
-17	536332A1	Tube and Valve Assembly, Balance		1	1							1			
-18	536332	. Tube Assembly, Balance		1	1							1			
-19	536326	. Ring, Internal Retaining		1	1							1			
-20	538433	. Valve, Manifold Drain		1	1							1			
-21	535787	Clamp, Balance Tube		2	2							2			
ATTACHING PARTS															
-22	MS35338-44	Washer, Lock		4	4							4			
-23	AN520-416-12	Screw, Machine		4	4							4			
		* * * *													
-24	535784	Bracket, Balance Tube, Right Side		1	1							1			
-25	535785	Bracket, Balance Tube, Left Side		1	1							1			
ATTACHING PARTS															
-26	501868	Washer, Tab, 5/16 Inch		4	4							4			
-27	AN75A15	Bolt		4											
-27	537961	Bolt, 5/16 X 1 Inch Long										4			
-27	535960	Bolt, 5/16 X 13/16 Inch Long				4									
		* * * *													
-28	536871	Tube, Elbow, Left Side		1	1							1			
-29	536872	Tube, Elbow, Right Side		1	1							1			
-30	538469	Bracket Assembly, Carburetor Support		1	1							1			
-31	AN4-26A	Bolt		1	1							1			
-32	AN364-428	Nut, Self-locking		1	1							1			
-33	538468	Bushing, Carburetor Support Bracket		2	2							2			
-34	634807	Bracket, Carburetor Support, Right Hand		1	1							1			
-35	539113	Bracket, Carburetor Support, Left Hand		1	1							1			
-36	20522	Washer, Plain		1	1							1			
-37	22661	Nut, Self-locking		1	1							1			
-38	25135	& Gasket, Carburetor Air Scoop		1	1							1			
-39	536911	@ Carburetor, Model PSD-5C (Bendix No. 391435)				1									
-39	627178	@ Carburetor, Model PSD-5C (Bendix No. 391668-2)		1								1			
ATTACHING PARTS															
-40	2439	Nut, Hex		4	4							4			
-41	MS35338-45	Washer, Lock		4	4							4			
-42	2473	Washer, Plain		4	4							4			
		* * * *													
-43	35985	& Gasket, Carburetor		1	1							1			
-44	537939	Bracket, Crankcase-to-Riser		2											
ATTACHING PARTS															
-45	2473	Washer, Plain		1								1			
-46	MS35338-45	Washer, Lock		3								3			
-47	536795	Screw, Hex Head, 5/16 X 3/4 Inch Long		1								1			
-48	538996	Spacer, 11/32 Inch X 3/16 Inch Thick		2								2			
-49	537750	Screw, Hex Head, 5/16 X 1-43/64 Inch Lg.		2								2			
		* * * *													
-50	538434A1	Riser Assembly, Manifold		1	1							1			
-51	No Number	. Riser, Manifold		ns	ns							ns			
-52	629518-1H	. Plug, Pipe, 1/8 Inch NPT		2	1							1			
-53	401824	† . Stud, 5/16 X 1-1/2 Inch Long		4	4							4			

@ See Section VI for Specification Applications.

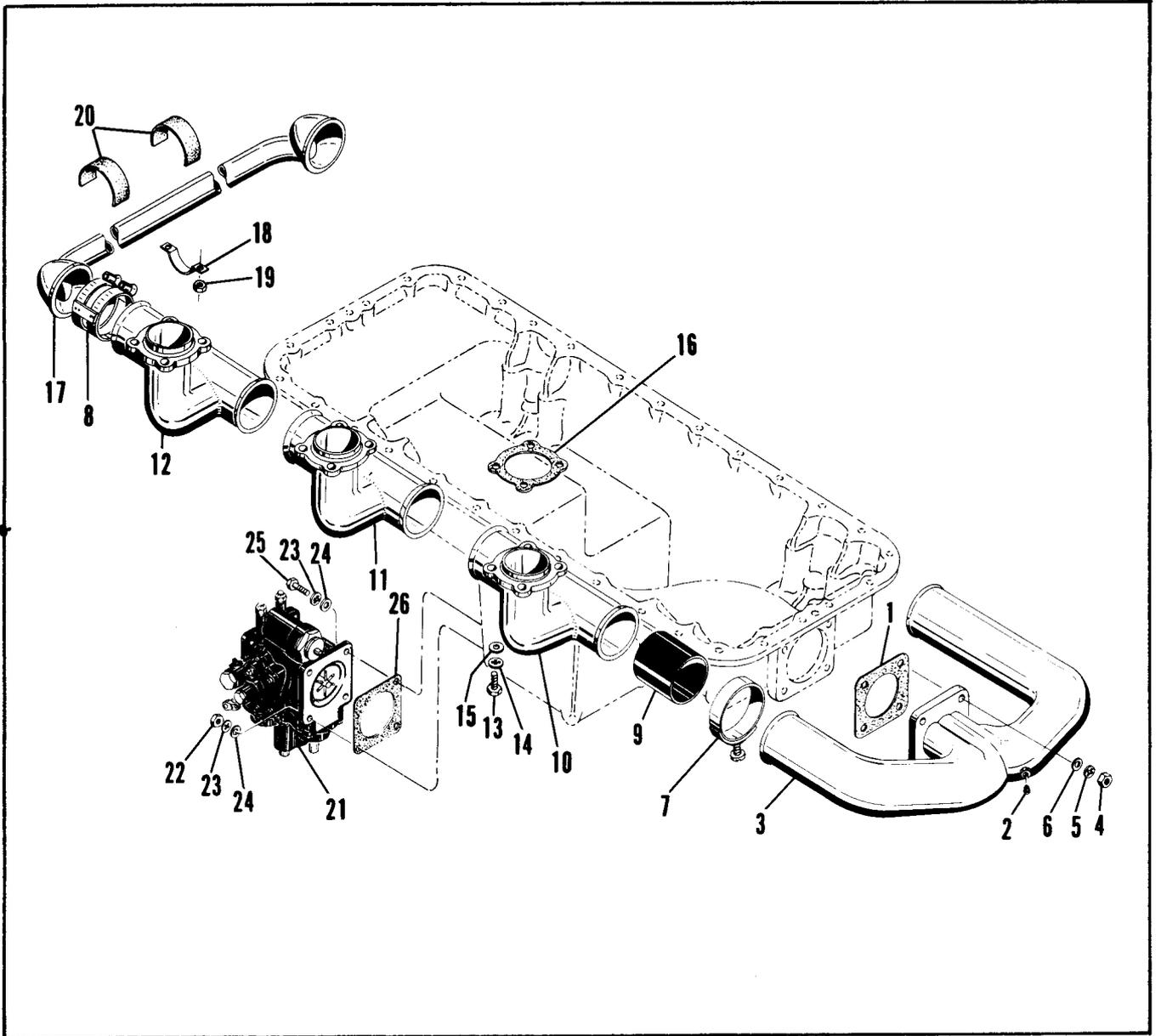

FIGURE 52 . INDUCTION SYSTEM
MODELS O-470-G, P

FIG. & INDEX	PART NUMBER	DESCRIPTION	QUANTITY PER ASSEMBLY												
			A	B	E	G	J	K	L	M	P	R			
51-13	539571	& Hose, Riser-to-Elbow		2								2			
-14	36151J	Clamp, Hose		4	16							8			
-15	631972	Clamp, Hose		4								8			
-16	539487	Clamp Assembly, Hose		2	2							2			
-17	536332A1	Tube and Valve Assembly, Balance		1	1							1			
-18	536332	. Tube Assembly, Balance		1	1							1			
-19	536326	. Ring, Internal Retaining		1	1							1			
-20	538433	. Valve, Manifold Drain		1	1							1			
-21	535787	Clamp, Balance Tube		2	2							2			
		ATTACHING PARTS													
-22	MS35338-44	Washer, Lock		4	4							4			
-23	AN520-416-12	Screw, Machine		4	4							4			
		* * * *													
-24	535784	Bracket, Balance Tube, Right Side		1	1							1			
-25	535785	Bracket, Balance Tube, Left Side		1	1							1			
		ATTACHING PARTS													
-26	501868	Washer, Tab, 5/16 Inch		4	4							4			
-27	AN75A15	Bolt		4											
-27	537961	Bolt, 5/16 X 1 Inch Long										4			
-27	535960	Bolt, 5/16 X 13/16 Inch Long			4										
		* * * *													
-28	536871	Tube, Elbow, Left Side		1	1							1			
-29	536872	Tube, Elbow, Right Side		1	1							1			
-30	538469	Bracket Assembly, Carburetor Support		1	1							1			
-31	AN4-26A	Bolt		1	1							1			
-32	AN364-428	Nut, Self-locking		1	1							1			
-33	538468	Bushing, Carburetor Support Bracket		2	2							2			
-34	634807	Bracket, Carburetor Support, Right Hand		1	1							1			
-35	539113	Bracket, Carburetor Support, Left Hand		1	1							1			
-36	20522	Washer, Plain		1	1							1			
-37	22661	Nut, Self-locking		1	1							1			
-38	25135	& Gasket, Carburetor Air Scoop		1	1							1			
-39	536911	@ Carburetor, Model PSD-5C (Bendix No. 391435)			1										
-39	627178	@ Carburetor, Model PSD-5C (Bendix No. 391668-2)		1								1			
		ATTACHING PARTS													
-40	2439	Nut, Hex		4	4							4			
-41	MS35338-45	Washer, Lock		4	4							4			
-42	2473	Washer, Plain		4	4							4			
		* * * *													
-43	35985	& Gasket, Carburetor		1	1							1			
-44	537939	Bracket, Crankcase-to-Riser		2											
		ATTACHING PARTS													
-45	2473	Washer, Plain		1								1			
-46	MS35338-45	Washer, Lock		3								3			
-47	536795	Screw, Hex Head, 5/16 X 3/4 Inch Long		1								1			
-48	538996	Spacer, 11/32 Inch X 3/16 Inch Thick		2								2			
-49	537750	Screw, Hex Head, 5/16 X 1-43/64 Inch Lg.		2								2			
		* * * *													
-50	538434A1	Riser Assembly, Manifold		1	1							1			
-51	No Number	. Riser, Manifold		ns	ns							ns			
-52	629518-1H	. Plug, Pipe, 1/8 Inch NPT		2	1							1			
-53	401824	† . Stud, 5/16 X 1-1/2 Inch Long		4	4							4			

@ See Section VI for Specification Applications.

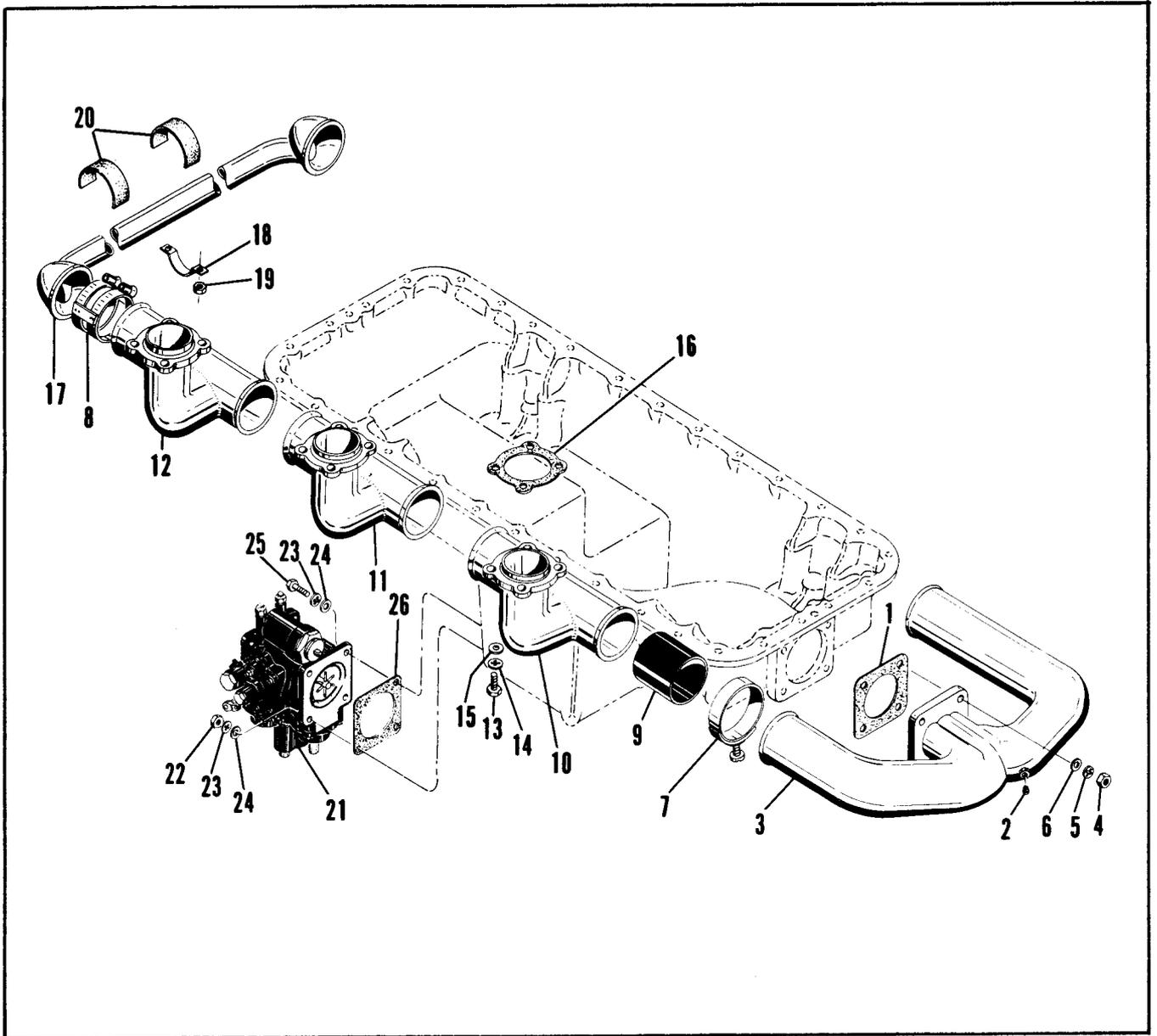

FIGURE 52. INDUCTION SYSTEM
MODELS O-470-G, P

FIG. & INDEX	PART NUMBER	DESCRIPTION	QUANTITY PER ASSEMBLY											
			A	B	E	G	J	K	L	M	P	R		
52- 1	35985	& Gasket, Manifold				1							1	
- 2	20882	Plug, Pipe, 1/8 Inch NPT				1							1	
- 3	538927	Manifold Assembly, Rear				1							1	
		ATTACHING PARTS												
- 4	2439	Nut, Hex				4							4	
- 5	MS35338-45	Washer, Lock				4							4	
- 6	22533	Washer, Plain				4							4	
		* * * *												
- 7	36151J	Clamp, Hose				12							12	
- 8	539487	Clamp Assembly, Hose				2							2	
- 9	539571	& Hose, Intake Manifold				8							8	
-10	537874	Tube Assembly, Intake Manifold No. 2				1							1	
-11	537875	Tube Assembly, Intake Manifold No. 3, 4				2							2	
-12	537873	Tube Assembly, Intake Manifold, No. 1, 5, 6				3							3	
		ATTACHING PARTS												
-13	24835	Bolt, 1/4 X 7/8 Inch Long				24							24	
-14	MS35338-44	Washer, Lock				24							24	
-15	20522	Washer, Plain				24							24	
		* * * *												
-16	536413	& Gasket, Intake Manifolds				6							6	
-17	538882	Tube Assembly, Balance				1							1	
-18	625411	Clamp, Balance Tube				2							2	
		ATTACHING PARTS												
-19	22661	Nut, Self-locking				4							4	
		* * * *												
-20	532364-.50	Felt, Sump-to-Balance Tube				2							2	
-21	628023	@ Carburetor, Model PSH-5BD (Bendix No. 391735-1)				1							1	
		ATTACHING PARTS												
-22	2439	Nut, Hex				2							2	
-23	MS35338-45	Washer, Lock				4							4	
-24	22533	Washer, Plain				4							4	
-25	537961	Bolt, 5/16 X 1 Inch Long				2							2	
		* * * *												
-26	35985	& Gasket, Carburetor				1							1	

@ See Section VI for Specification Applications.

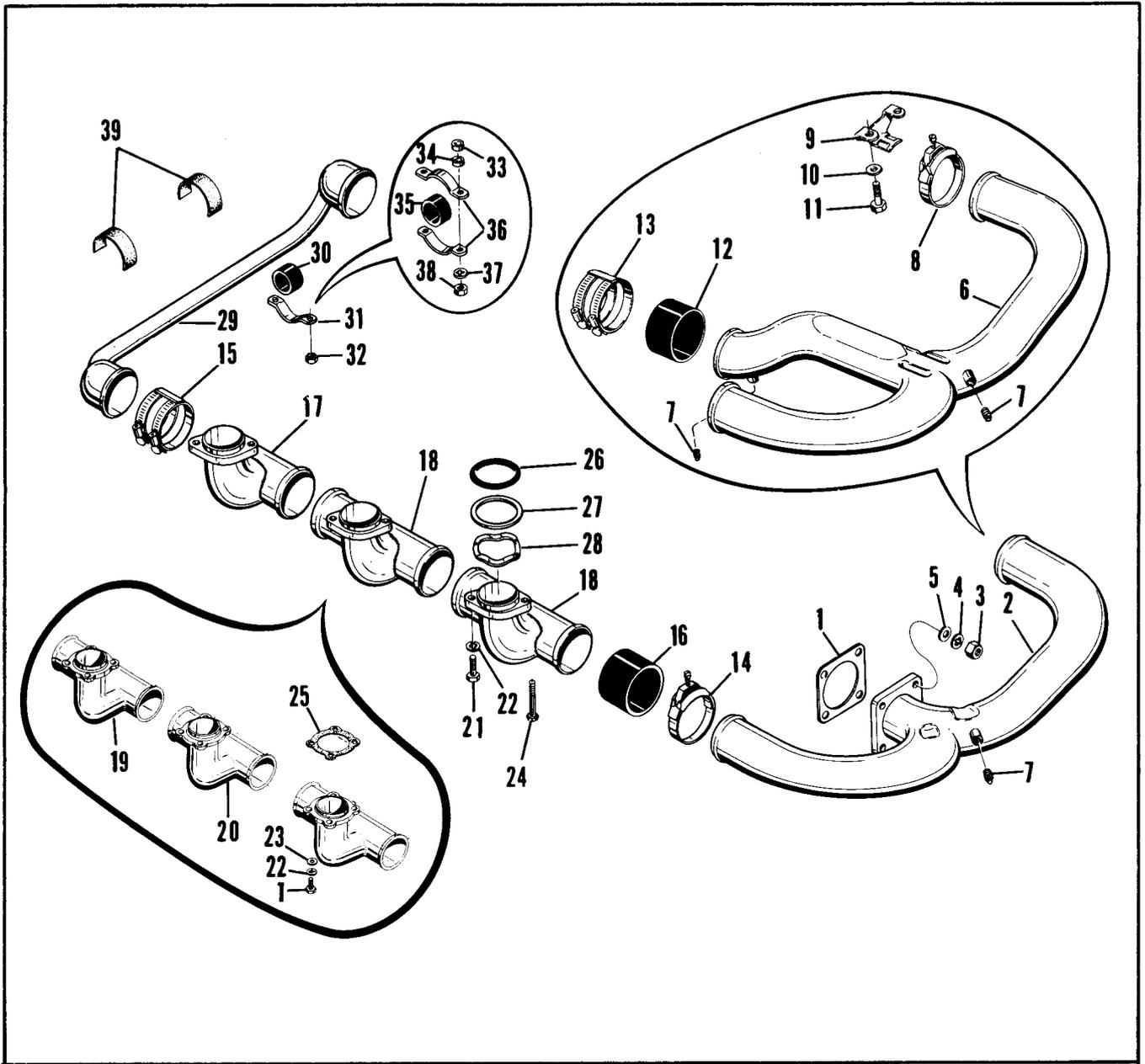

FIGURE 53. INDUCTION SYSTEM
MODELS 10-470-C, H, J, K, N

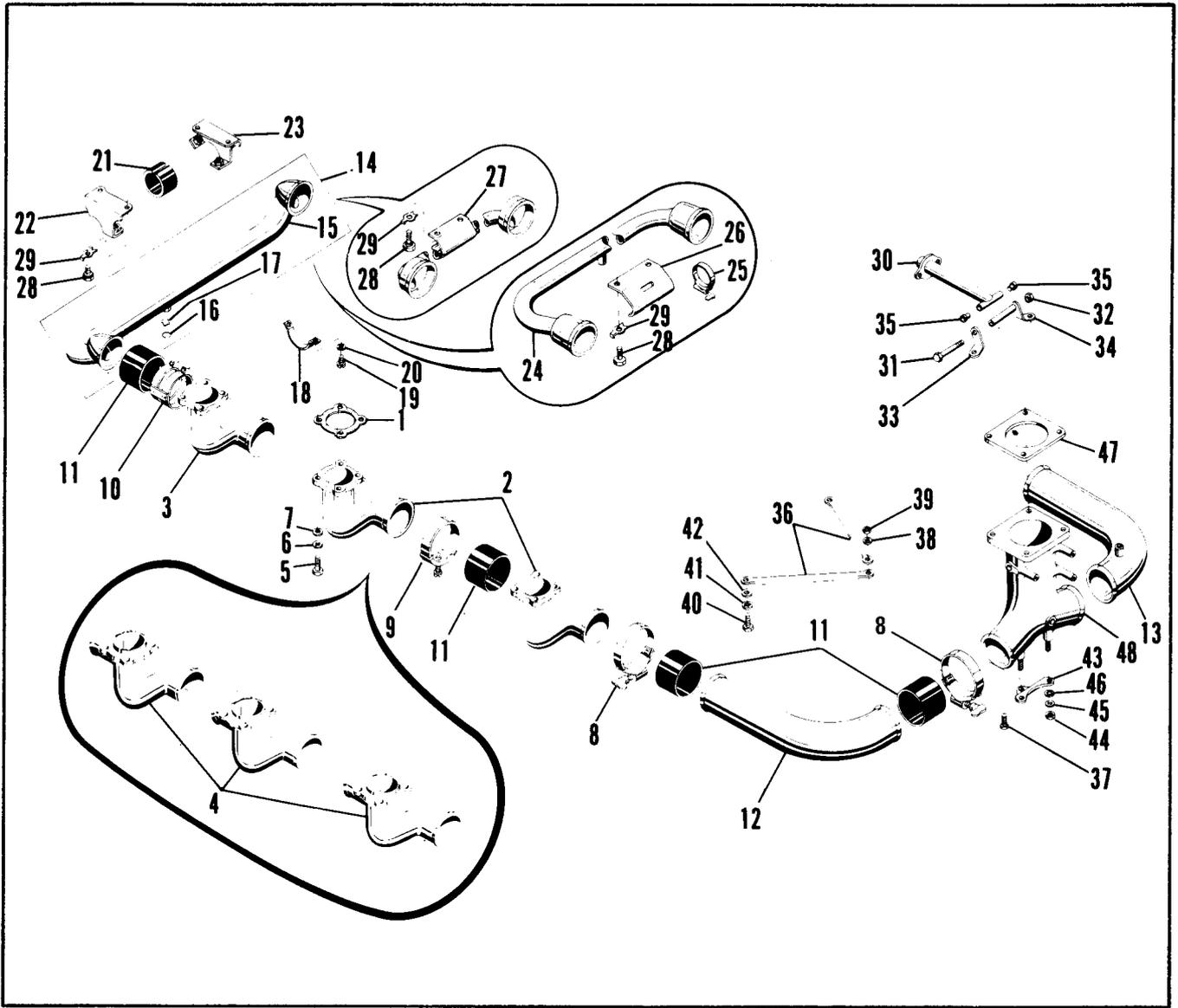

FIGURE 54 . INDUCTION SYSTEM
 MODELS 10-470-D, E, G, L, P, R, U, V

FIG. & INDEX	PART NUMBER	DESCRIPTION	QUANTITY PER ASSEMBLY															
			C	D	E	F	G	H	J	K	L	M	N	P	R	S	U	V
54- 1	536413	& Gasket, Intake Manifold		6	6		6				6			6	6		6	6
- 2	629138	Tube Assembly, Intake Manifold, No. 1, 2, 3, 4, 5		5							5						5	5
- 3	629325	Tube Assembly, Intake Manifold, No. 6		1						1							1	1
- 4	629138	Tube Assembly, Intake Manifolds			6		6							6	6			
		ATTACHING PARTS																
- 5	24835	Bolt, 1/4-20 X 7/8 Inch Long		24	24		24				24			24	24		24	24
- 6	MS35338-44	Washer, Lock		24	24		24				24			24	24		24	24
- 7	20522	Washer, Plain		24	24		24				24			24	24		24	24
		* * * *																
- 8	631972	Clamp, Hose		8	8		8				8			8	8		8	8
- 9	36151L	Clamp, Hose		8	8		8				8			8	8		8	8
-10	539487	Clamp Assembly, Hose		2	2		2				2			2	2		2	2
-11	639660-11	Hose, Intake Manifold		10	10		10				10			10	10		10	10
-12	627011	Tube, Elbow, Left Side			1		1				1			1	1			

FIG. & INDEX	PART NUMBER	DESCRIPTION	QUANTITY PER ASSEMBLY																
			C	D	E	F	G	H	J	K	L	M	N	P	R	S	U	V	
54-12	626744	Tube, Elbow, Left Side		1														1	
-13	629595	Tube, Elbow, Right Side			1		1				1			1	1				
-13	629597	Tube, Elbow, Right Side		1														1	
-14	627250A1	Tube and Valve Assembly, Balance		1															
-15	No Number	. Tube Assembly, Balance		ns														ns	
-16	536326	. Ring, Internal Retaining		1														1	
-17	538433	. Valve, Manifold Drain		1														1	
-18	535787	Clamp, Bracket		2															
		ATTACHING PARTS																	
-19	AN520-416-12	Screw, Hex Head		4															
-20	MS35338-44	Washer, Lock		4															
		* * * *																	
-21	627254	Tube, Balance Tube Clamp		2															
-22	535785	Bracket, Balance Tube, Left Side		1															
-23	535784	Bracket, Balance Tube, Right Side		1															
-24	628701	Tube Assembly, Balance									1						1	1	
-25	AN737TW46	Clamp, Balance Tube									1						1	1	
-26	632280	Bracket, Balance Tube									1						1	1	
-27	630627	Tube Assembly, Balance			1		1							1	1				
		ATTACHING PARTS																	
-28	537961	Bolt, 5/16-18 X 1 Inch Long		4	4		4							4	4		4		
-29	501868	Washer, Tab		4	4		4							4	4		4		
		* * * *																	
-30	538469	Bracket Assembly, Air Throttle		1														1	1
-30	627390	Bracket Assembly, Air Throttle			1		1				1			1	1				
-31	AN4-26A	Bolt		1	1		1							1	1		1	1	
-31	AN4-27A	Bolt									1								
-32	AN364-428	Nut, Self-locking		1	1		1				1			1	1		1	1	
-33	634805	Bracket, Air Throttle Support, Left-hand		1	1		1				1			1	1		1	1	
-34	634807	Bracket Assembly		1	1		1				1			1	1		1	1	
-35	538468	Bushing, Air Throttle Support		2	2		2				2			2	2		2	2	
-36	627681	Bracket, Crankcase-to-air throttle		2	2		2				2			2	2		2	2	
		ATTACHING PARTS																	
-37	535666	Screw, Hex Head, 5/16-24 X 5/8 Inch Long		1	1		1				1			1	1		1	1	
-38	MS35338-45	Washer, Lock		1	1		1				1			1	1		1	1	
-39	2439	Nut, Hex		1	1		1				1			1	1		1	1	
-40	537750	Screw, Hex Head, 5/16-18 X 1-1/8 Inch Lg.		2	2		2				2			2	2		2	2	
-41	13XX202B	Washer, Lock		2	2		2				2			2	2		2	2	
-42	2473	Washer, Plain		2	2		2				2			2	2		2	2	
		* * * *																	
-43	627836	Bracket, Air Throttle Support, Lower			1		1				1			1	1			1	
-43	627670	Bracket, Air Throttle Support, Lower		1														1	1
		ATTACHING PARTS																	
-44	2437	Nut, Hex, 1/4		2	2		2				2			2	2		2	2	
-45	MS35338-44	Washer, Lock		2	2		2				2			2	2		2	2	
-46	20522	Washer, Plain			2		2				2			2	2				
		* * * *																	
-47	627368	& Gasket, Air Throttle		1	1		1				1			1	1		1	1	
-48	No Number	Throttle Assembly, Air		ns	ns		ns				ns			ns	ns		ns	ns	

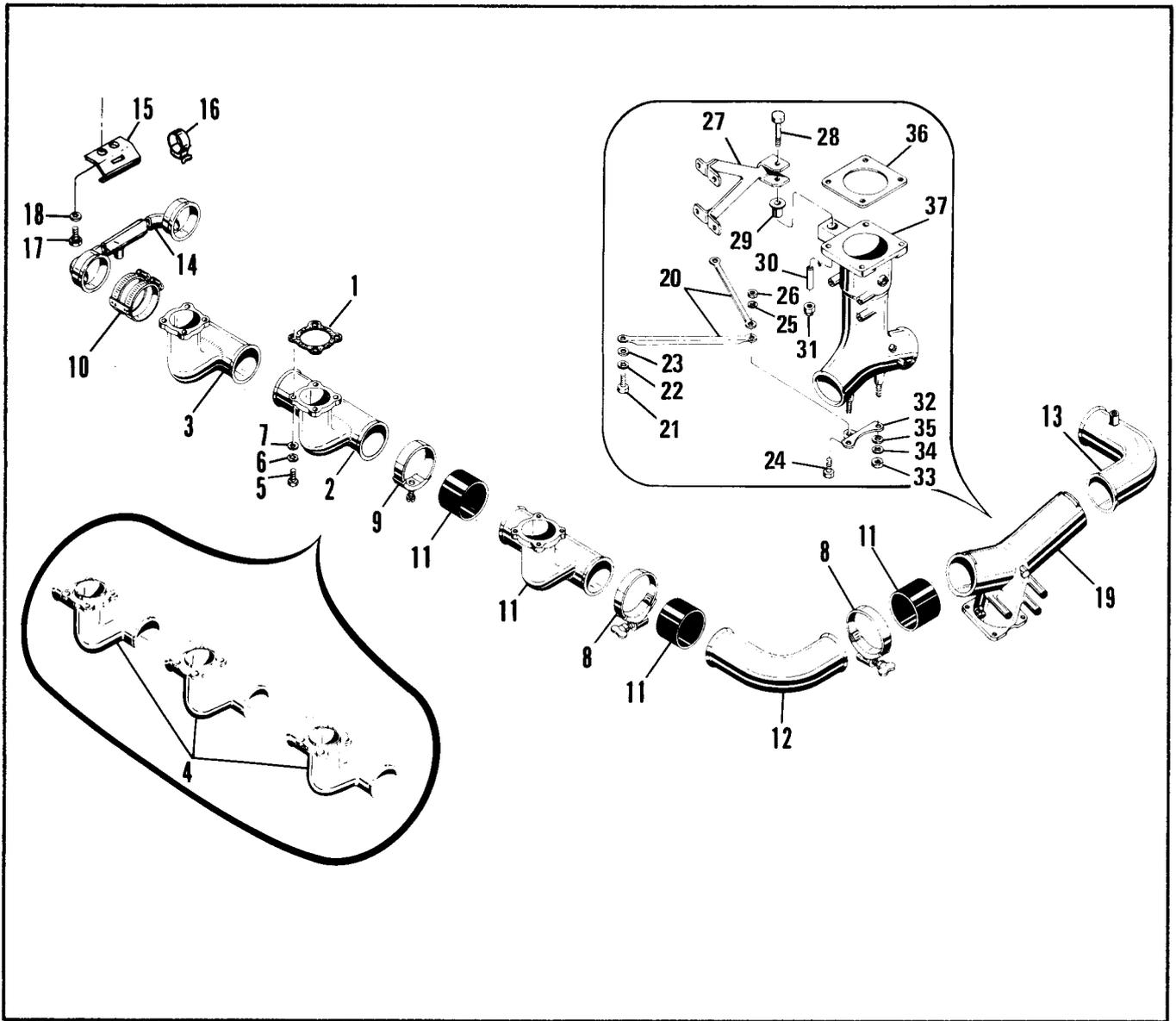

FIGURE 55. INDUCTION SYSTEM
MODELS 10-470-F, S

FIG. & INDEX	PART NUMBER	DESCRIPTION	QUANTITY PER ASSEMBLY																	
			C	D	E	F	G	H	J	K	L	M	N	P	R	S	U	V		
55- 1	536413	& Gasket, Intake Manifold				6												6		
- 2	629138	Tube Assembly, Intake Manifold, No. 1, 2, 3, 4, 5																		
- 3	629325	Tube Assembly, Intake Manifold, No. 6				5														
- 4	629138	Tube Assembly, Intake Manifold				1													6	
ATTACHING PARTS																				
- 5	24835	Bolt, 1/4 X 7/8 Inch Long					24												24	
- 6	MS35338-44	Washer, Lock					24												24	
- 7	20522	Washer, Plain					24												24	
* * * *																				

FIG. & INDEX	PART NUMBER	DESCRIPTION	QUANTITY PER ASSEMBLY															
			C	D	E	F	G	H	J	K	L	M	N	P	R	S	U	V
55- 8	631972	Clamp, Hose				8											8	
- 9	36151L	Clamp, Hose				8											8	
-10	539487	Clamp Assembly, Hose				2											2	
-11	539571	& Hose, Intake Manifold				10											10	
-12	535681	Tube, Elbow, Left Side				1											1	
-12	627011	Tube, Elbow, Left Side																
-13	627820	Tube, Elbow, Right Side				1											1	
-13	629595	Tube, Elbow, Right Side																
-14	630628	Tube Assembly, Balance				1											1	
-14	630627	Tube Assembly, Balance																
-15	630296	Bracket, Balance Tube				1											1	
-16	AN737TW26	Clamp, Balance Tube				1											1	
		ATTACHING PARTS																
-17	530346	Screw, Hex Head, 5/16 X 7/8 Inch Long				2												
-17	537961	Screw, 5/16-18 X 1 Inch Long															4	
-18	13XX202B	Washer, Lock				2												
-18	501868	Washer, Tab															4	
		* * * *																
-19	No Number	Throttle Assembly, Air				ns												
		* * * *																
-20	627681	Bracket, Crankcase-to-air throttle															2	
		ATTACHING PARTS																
-21	537750	Bolt, 5/61-18 X 1-1/8 Inch Long															2	
-22	13XX202B	Washer, Lock															2	
-23	2473	Washer, Plain															2	
-24	535666	Screw, Hex Head, 5/16 X 5/8 Inch Long															1	
-25	MS35338-45	Washer, Lock															1	
-26	2439	Nut, Hex															1	
		* * * *																
-27	630474	Bracket Assembly, Air Throttle															1	
-28	537728	Bolt, 1/4-28 X 25/32 Inch Long															1	
-29	629353	Bushing, Air Throttle Support															2	
-30	629354	Sleeve, Air Throttle Support															1	
-31	22661	Nut, Self-locking															1	
-32	627836	Bracket, Air Throttle Support, Lower															1	
		ATTACHING PARTS																
-33	2437	Nut, Hex															2	
-34	MS35338-44	Washer, Lock															2	
-35	20522	Washer, Plain															2	
		* * * *																
-36	627368	& Gasket, Air Throttle															1	
-37	No Number	Throttle Assembly, Air															ns	

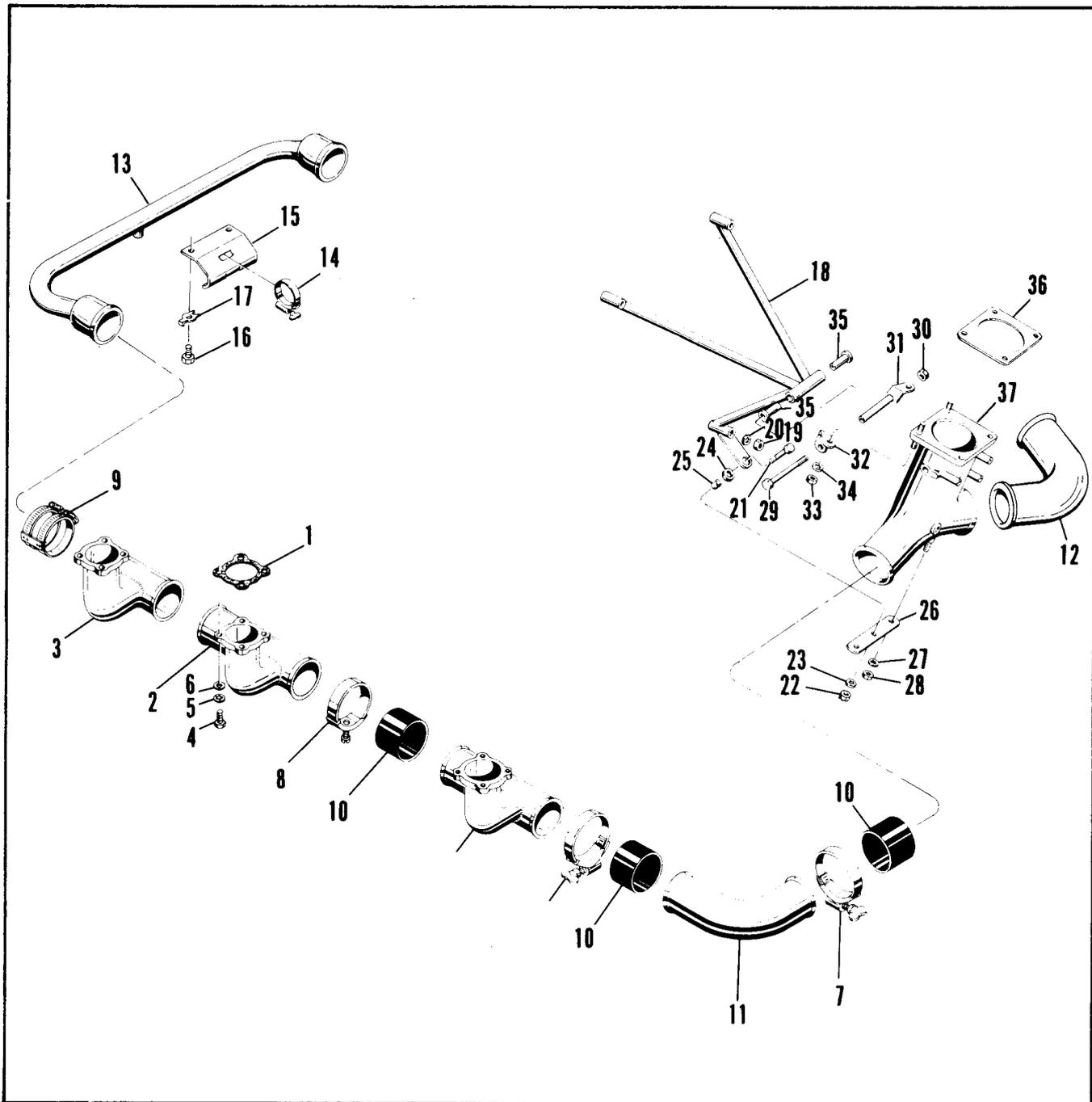

FIGURE 56. INDUCTION SYSTEM
MODEL 10-470-M

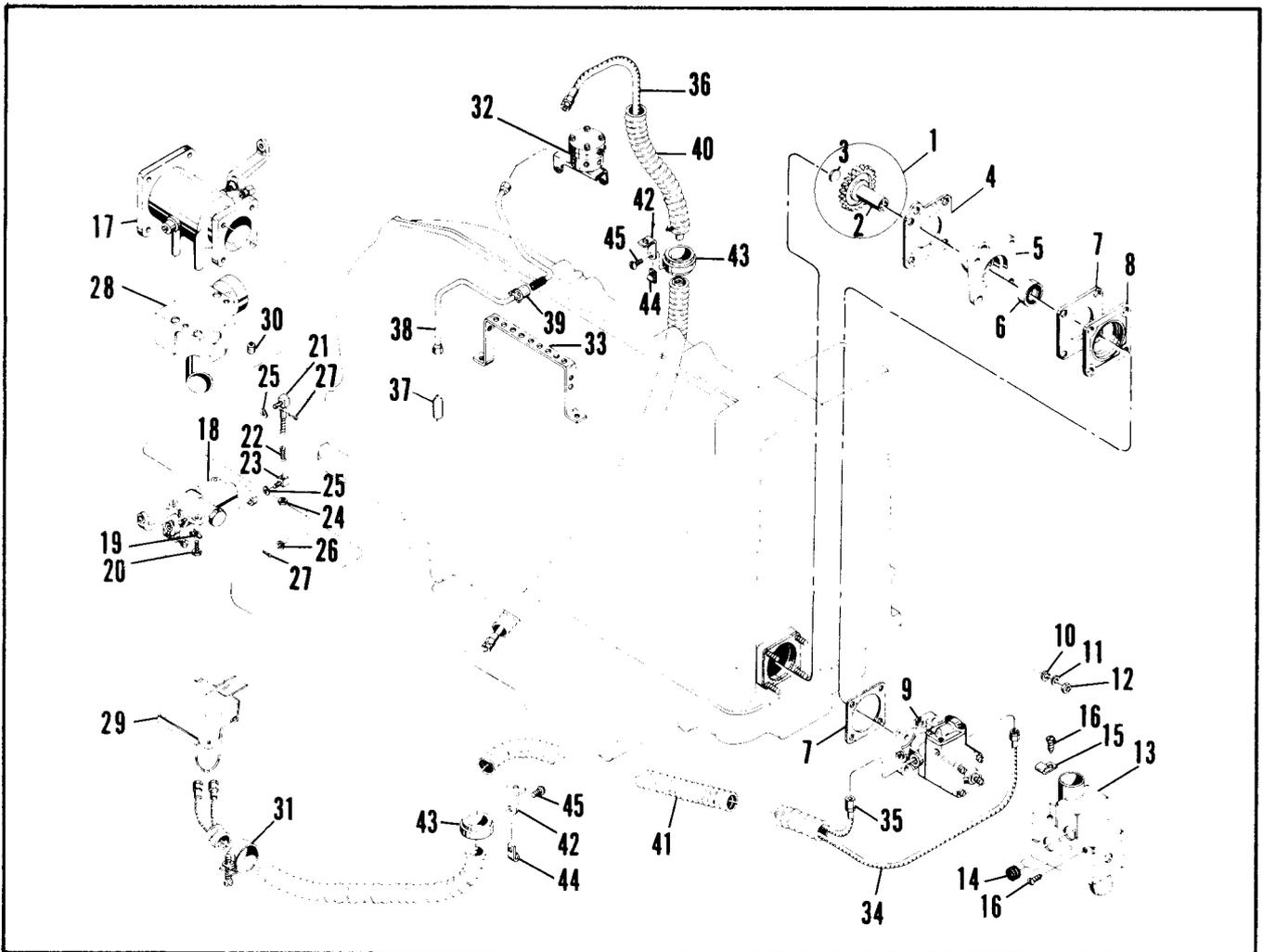

FIGURE 57. FUEL INJECTION SYSTEM
MODELS 10-470-C, H, J

FIG. & INDEX	PART NUMBER	DESCRIPTION	QUANTITY PER ASSEMBLY															
			C	D	E	F	G	H	J	K	L	M	N	P	R	S	U	V
57- 1	534995	Gear Assembly, Fuel Pump Drive	1						1	1								
- 2	No Number	. Gear, Fuel Pump Drive	ns					ns	ns									
- 3	539634	. Plug, Fuel Pump Gear	1					1	1									
- 4	534941	& Gasket, Adapter-to-Crankcase	1					1	1									
	627518	Adapter Assembly, Fuel Pump	1					1	1									
- 5	No Number	. Adapter, Fuel Pump	ns					ns	ns									
- 6	534956	& . Seal, Oil	1					1	1									
- 7	AN4059-1	& Gasket	2					2	2									
- 8	626839	Insulator, Fuel Pump	1					1	1									
	639246A1	Fuel Injector Equipment, Complete	1					1										
	639248A1	Fuel Injector Equipment, Complete							1									
- 9	638156-3A1	. Fuel Pump and Vapor Separator Assy.	1					1	1									
		ATTACHING PARTS																
-10	2473	. Washer, Plain	4					4	4									
-11	MS35338-45	. Washer, Lock	4					4	4									
-12	2439	. Nut, Plain Hex	4					4	4									
		* * * * *																
-13	639268	* . Shroud Assembly, Fuel Pump	1					1	1									
-14	626879-1	. Grommet, Fuel Pump Shroud	4					4	4									

*Use 626860 Shroud Assembly with old style pump.

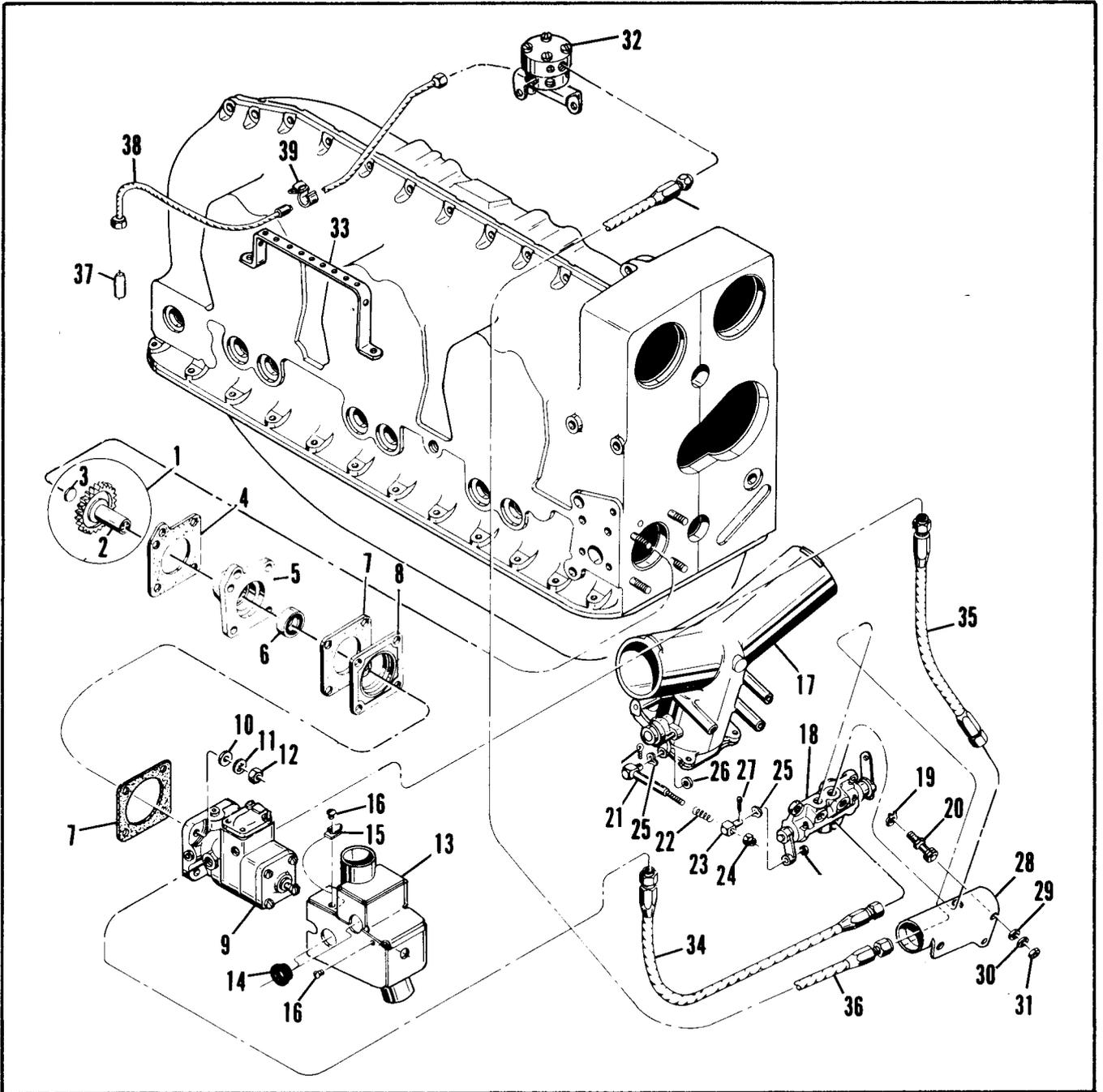

FIGURE 58. FUEL INJECTION SYSTEM
MODELS 10-470-F

FIG. & INDEX	PART NUMBER	DESCRIPTION	QUANTITY PER ASSEMBLY																			
			C	D	E	F	G	H	J	K	L	M	N	P	R	S	U	V				
58- 1	534995	Gear Assembly, Fuel Pump Drive				1																
- 2	No Number	. Gear, Fuel Pump Drive				ns																
- 3	539634	. Plug, Fuel Pump Gear				1																
- 4	534941	& Gasket, Adapter-to-Crankcase				1																
	627518	Adapter Assembly, Fuel Pump				1																
- 5	No Number	. Adapter, Fuel Pump				ns																
- 6	534956	& . Seal, Oil				1																

FIG. & INDEX	PART NUMBER	DESCRIPTION	QUANTITY PER ASSEMBLY																
			C	D	E	F	G	H	J	K	L	M	N	P	R	S	U	V	
58- 7	AN4059-1	& Gasket				2													
- 8	626839	Insulator, Fuel Pump				1													
	640107A1	Fuel Injector Equipment, Complete				1													
- 9	638156-3A11	. Fuel Pump & Vapor Separator Assembly				1													
		ATTACHING PARTS																	
-10	2473	. Washer, Plain				4													
-11	MS35338-45	. Washer, Lock				4													
-12	2439	. Nut, Plain Hex				4													
		* * * * *																	
-13	639268	* . Shroud Assembly, Fuel Pump				1													
-14	626879-1	. Grommet, Fuel Pump Shroud				4													
-15	534337	. Nut, Tinnerman, Type J				4													
-16	AN526-1024-4	. Screw				4													
	640120A1	. Throttle & Control Assembly				1													
-17	639766A1	. . Throttle & Lever Assembly (For detail parts see Figure 65)				1													
-18	625219-2A7	. . Control Assembly, Complete				1													
		ATTACHING PARTS																	
-19	501867	. . Washer, Tab				3													
-20	630387	. . Bolt, Special, 1-7/8 Inch Long				3													
		* * * * *																	
	625539A1	. . Link Rod Assembly				1													
-21	625539	. . . Rod & Link Assembly				1													
-22	626634	. . . Spring, Compression				1													
-23	625542	. . . Rod End, Special				1													
-24	MS20365-1032A	. . . Nut, Elastic Stop				1													
-25	625327-2	. . Washer, Wave				2													
-26	537690	. . Washer, Plain				2													
-27	2500	. . Pin, Cotter				2													
-27	632859A1	. Shroud Assembly, Metering Unit, Complete				1													
-28	632859	. . Shroud, Metering Unit				1													
		ATTACHING PARTS																	
-29	20522	. . Washer, Plain				3													
-30	MS35338-44	. . Washer, Lock				3													
-31	2437	. . Nut				3													
		* * * * *																	
-32	631427A3	. Valve Assembly, Fuel Manifold (For detail parts see Figure 66)				1													
-33	526486	. Bracket, Fuel Discharge Tubes				RF													
-34	MS28741-4-0160	. Hose Assembly, Flexible, 1/4 ID X 16 Inches Long				1													
-35	MS28741-4-0084	. Hose Assembly, Flexible, 1/4 ID X 9 Inches Long				1													
-36	MS28741-4-0044	. Hose Assembly, Flexible, 1/4 ID X 44 Inches Long				1													
-37	627335D12	. Nozzle Assembly, Fuel Injection				6													
-38	628154	. Tube Assembly, Fuel Discharge No. 1 & 6				2													
-38	628153	. Tube Assembly, Fuel Discharge No. 2 & 5				2													
-38	628152	. Tube Assembly, Fuel Discharge No. 3 & 4				2													
-39	626577-2	. Clamp, Fuel Discharge Tubes				6													

*Use 626860 Shroud Assembly with old style pump.

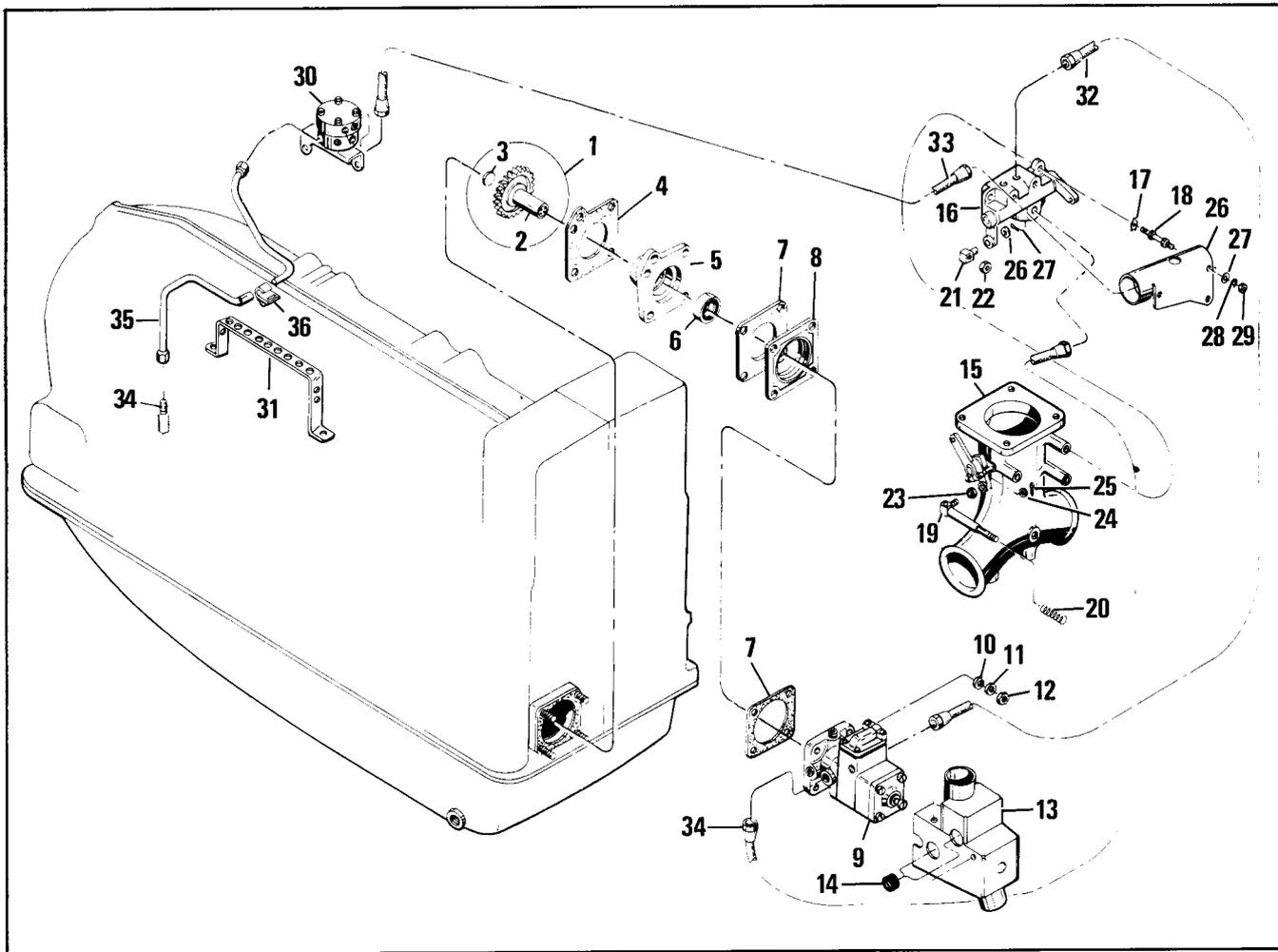

FIGURE 60. FUEL INJECTION SYSTEM
MODEL IO-470-L

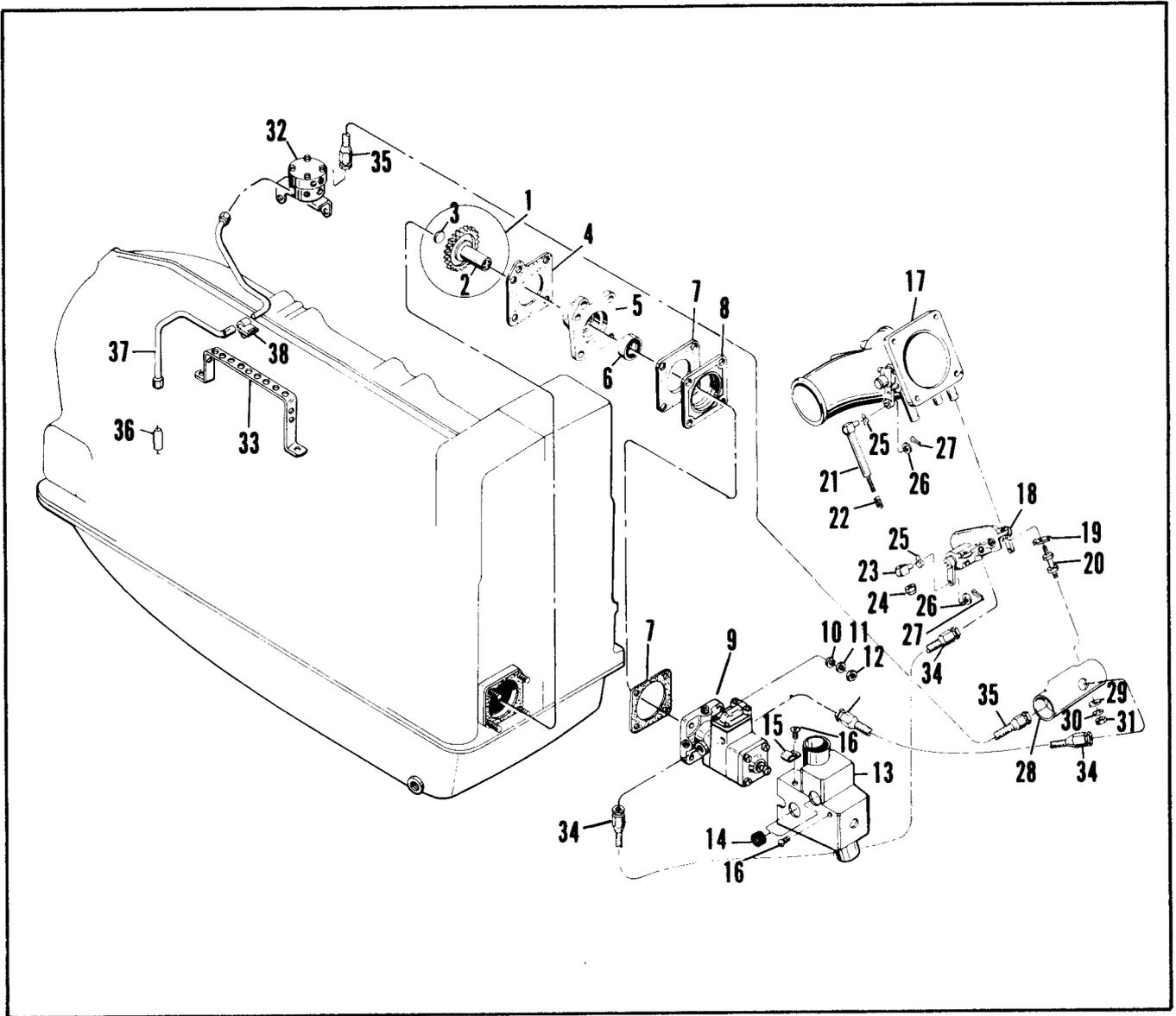

FIGURE 61. FUEL INJECTION SYSTEM
MODEL 10-470-M

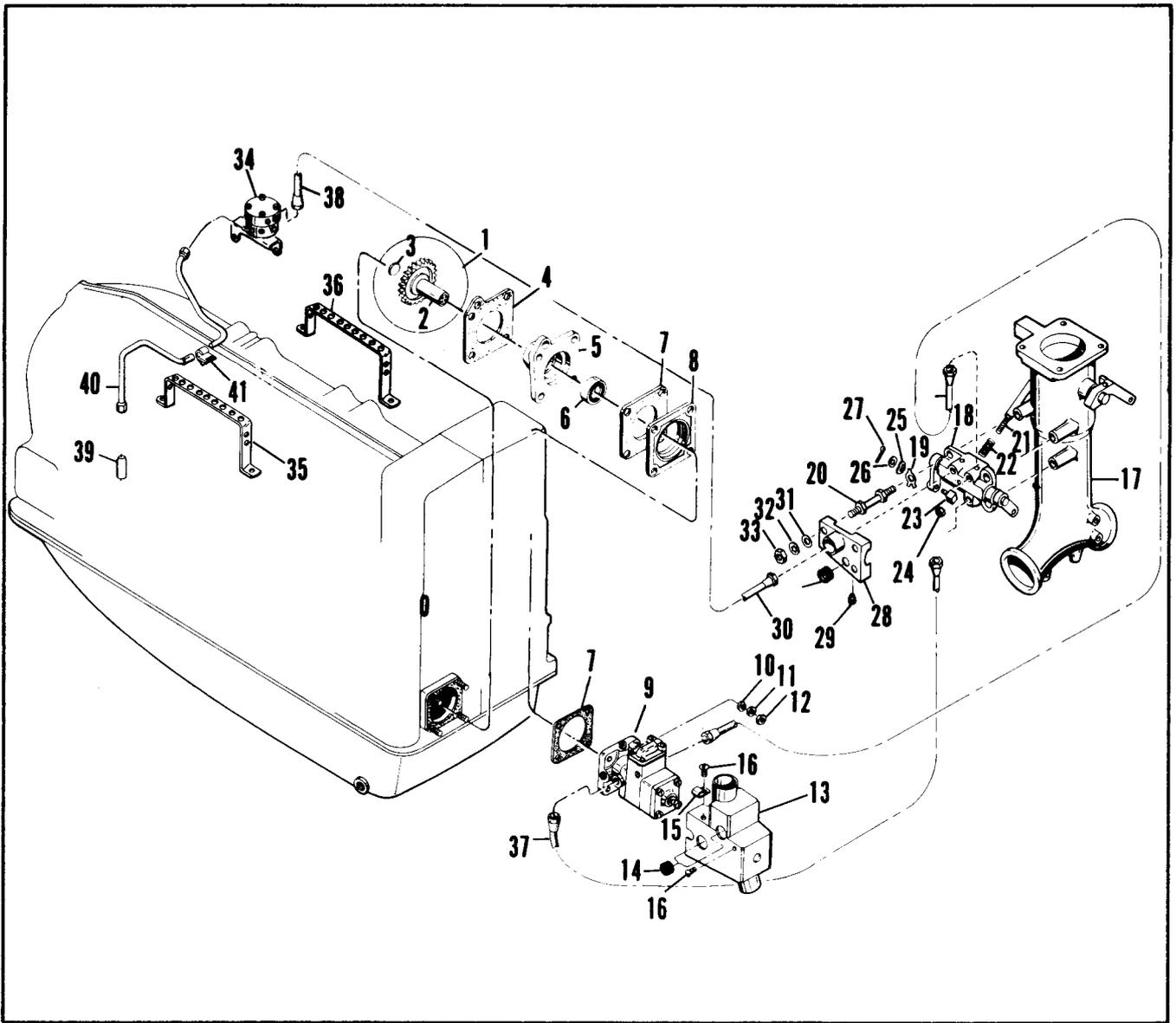

FIGURE 62. FUEL INJECTION SYSTEM
MODEL 10-470-S

FIG. & INDEX	PART NUMBER	DESCRIPTION	QUANTITY PER ASSEMBLY																
			C	D	E	F	G	H	J	K	L	M	N	P	R	S	U	V	
62- 1	534995	Gear Assembly, Fuel Pump Drive																1	
- 2	No Number	. Gear, Fuel Pump Drive																ns	
- 3	539634	. Plug, Fuel Pump Gear																1	

FIG. & INDEX	PART NUMBER	DESCRIPTION	QUANTITY PER ASSEMBLY																
			C	D	E	F	G	H	J	K	L	M	N	P	R	S	U	V	
62- 4	534941	& Gasket, Adapter-to-Crankcase																1	
	627518	Adapter Assembly, Fuel Pump																1	
- 5	No Number	. Adapter, Fuel Pump																ns	
- 6	534956	& . Seal, Oil																1	
- 7	AN4059-1	& Gasket																2	
- 8	626839	Insulator, Fuel Pump																1	
	639264A1	Fuel Injector Equipment, Complete																1	
- 9	638156-3A8	. Fuel Pump & Vapor Separator Assy																1	
		ATTACHING PARTS																	
-10	2473	. Washer, Plain																4	
-11	MS35338-45	. Washer, Lock																4	
-12	2439	. Nut, Plain Hex																4	
		* * * *																	
-13	639266	. Shroud Assembly, Fuel Pump																1	
-14	626879-1	. Grommet, Fuel Pump Shroud																4	
-15	534337	. Nut, Tinnerman, Type J																4	
-16	AN516-1024-1	. Screw, Sheet Metal, 7/16 X 1/4 Inch Long																4	
	629399A1	. Throttle and Control Assembly																1	
-17	629397A1	. . Throttle & Lever Assembly																1	
		(For detail parts see Figure 65)																	
-18	629703-2A1	. . Control Assembly, Complete																1	
		ATTACHING PARTS																	
-19	501867	. . Washer, Tab																3	
-20	630387	. . Bolt, Special, 1-7/8 Inch Long																3	
		* * * *																	
	629364A1	. . Link Rod Assembly																1	
-21	629364	. . . Rod & Link Assembly																1	
-22	626634	. . . Spring, Compression																1	
-23	629330	. . . Rod End, Special																1	
-24	MS20365-1032A	. . . Nut, Elastic Stop																1	
-25	625327-2	. . Washer, Wave																2	
-26	537690	. . Washer, Plain																2	
-27	2500	. . Pin, Cotter																2	
	629338A1	. Shroud Assembly, Metering Unit, Complete																1	
-28	629338	. . Shroud Assembly																1	
-29	626891	. . Grommet, Rubber																2	
-30	626879-1	. . Grommet, Rubber																1	
		ATTACHING PARTS																	
-31	20522	. . Washer, Plain																3	
-32	MS35338-44	. . Washer, Lock																3	
-33	2437	. . Nut, Hex																3	
		* * * *																	
-34	631427A3	. Valve Assembly, Fuel Manifold																1	
		(For detail parts see Figure 66)																	
-35	628295	. Bracket, Fuel Discharge Tubes,																RF	
		1-3-5 Side																	
-36	628301	. Bracket, Fuel Discharge Tubes,																RF	
		2-4-6 Side																	
-37	MS28741-4-0180	. Hose Assy, Flexible, 1/4 ID X 18 Inch Lg.																2	
-38	MS28741-4-0330	. Hose Assy, Flexible, 1/4 ID X 33 Inch Lg.																1	
-39	627335	. Nozzle Assembly, Fuel Injector																6	
-40	628154	. Tube Assembly, Fuel Discharge No. 1 & 6																2	
-40	628153	. Tube Assembly, Fuel Discharge No. 2 & 5																2	
-40	628152	. Tube Assembly, Fuel Discharge No. 3 & 4																2	
-41	626577-2	. Clamp, Fuel Discharge Tubes																6	

FIG. & INDEX	PART NUMBER	DESCRIPTION	QUANTITY PER ASSEMBLY													U	V			
			C	D	E	F	G	H	J	K	L	M	N	P	R			S		
63-17	AN526-1024-4	. Screw, Sheet Metal, 7/16 X 1/4 Inch Long																	4	4
	630074A1	. Throttle and Control Assembly																	1	
	632855-2A1	. Throttle and Control Assembly																	1	
-18	630069A1	. Throttle Assembly																	1	
-18	633143A1	. Throttle Assembly																	1	
		(For detail parts see Figure 65)																		
-19	629904-2A1	. Control Assembly, Complete																	1	
-19	632916-2A2	. Control Assembly, Complete																	1	
		ATTACHING PARTS																		
-20	501867	. Washer, Tab																	3	3
-21	537629	. Screw, 1/4-20 X 21/32 Inch Long																	3	
-21	630387	. Screw, 1/4-20 X 1-7/8 Inch Long																	3	
		* * * *																		
	625539A1	. Link Rod Assembly																	1	
	632558A1	. Link Rod Assembly																	1	
-22	625539	. Rod & Link Assembly																	1	
-22	632558	. Rod & Link Assembly																	1	
-23	626634	. Spring, Compression																	1	1
-24	625542	. Rod End, Special																	1	
-24	632557	. Rod End, Special																	1	
-25	MS20365-1032A	. Nut, Elastic Stop																	1	1
-26	625327-2	. Washer, Wave																	2	2
-27	537690	. Washer, Plain																	2	2
-28	2500	. Pin, Cotter																	2	2
	627544A1	. Shroud Assembly, Metering Unit, Complete																	1	
-29	627544	. Shroud Assembly, Bottom																	1	
-30	627545	. Shroud Assembly, Cover																	1	
-29	633195	. Shroud Assembly, Bottom																	2	1
-30	633198	. Shroud Assembly, Cover																	2	1
-31	626879-1	. Grommet, Injector Shroud Bottom																	2	2
-32	537911	. Nut, Tinnerman, Type J																	2	2
-33	AN526-1024-4	. Screw, Sheet Metal, 7/16 X 1/4 In. Lg.																	2	2
-34	626891	. Grommet, Rubber																	2	2
-35	631427A1	. Valve Assembly, Fuel																	1	
-35	631351A6	. Valve Assembly, Fuel																	1	
		(For detail parts see Figure 66)																		
-36	628301	. Bracket, Fuel Discharge Tubes, 1-3-5 Side																	Rf	Rf
-37	628295	. Bracket, Fuel Discharge Tubes, 2-4-6 Side																	Rf	Rf
-38	635158-15.00	. Hose Assembly, Flexible, 1/4 ID X 15 Inches Long																	1	
-38	635158-16.00	. Hose Assembly, Flexible, 1/4 ID X 16 Inches Long																	1	
-39	635158-17.00	. Hose Assembly, Flexible, 1/4 ID X 17 Inches Long																	1	
-39	635158-18.00	. Hose Assembly, Flexible, 1/4 ID X 18 Inches Long																	1	
-40	635158-40.00	. Hose Assembly, Flexible, 1/4 ID X 40 Inches Long																	1	1
-41	627335-12	. Nozzle Assembly, Fuel Injector																	6	6
-42	628154	. Tube Assembly, Fuel Discharge No. 1 & 6																	2	2
-42	628153	. Tube Assembly, Fuel Discharge No. 2 & 5																	2	2
-42	628152	. Tube Assembly, Fuel Discharge No. 3 & 4																	2	2
-43	626577-2	. Clamp, Fuel Discharge Tube																	6	6
-44	625302-16	. Duct, Flexible, 1 Inch ID X 16 Inches Lg.																	2	
-45	AN737RM38	. Clamp, Flexible Duct																	2	

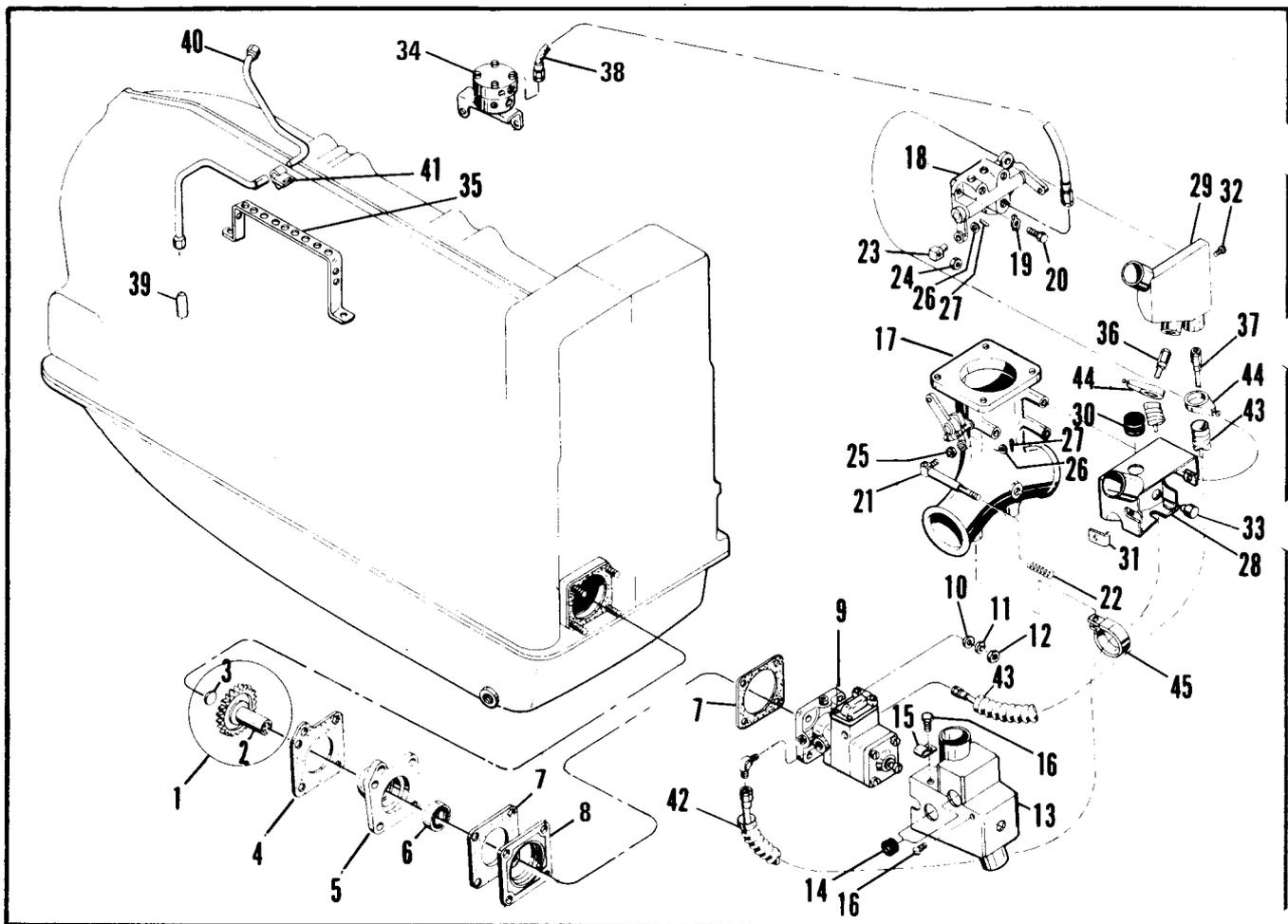

FIGURE 64. FUEL INJECTION SYSTEM
MODELS 10-470-D, E, G, P, R

FIG. & INDEX	PART NUMBER	DESCRIPTION	QUANTITY PER ASSEMBLY															
			C	D	E	F	G	H	J	K	L	M	N	P	R	S	U	V
64- 1	534995	Gear Assembly, Fuel Pump Drive		1	1		1								1	1		
- 2	No Number	. Gear, Fuel Pump Drive		ns	ns		ns								ns	ns		
- 3	539634	. Plug, Fuel Pump Gear		1	1		1								1	1		
- 4	534941	& Gasket, Adapter-to-Crankcase		1	1		1								1	1		
	627518	Adapter Assembly, Fuel Pump		1	1		1								1	1		
- 5	No Number	. Adapter, Fuel Pump		ns	ns		ns								ns	ns		
- 6	534956	& . Seal, Oil		1	1		1								1	1		
- 7	AN4059-1	& Gasket		2	2		2								2	2		
- 8	626839	Insulator, Fuel Pump		1	1		1								1	1		
	639257A1	Fuel Injector Equipment, Complete		1														
	639258A1	Fuel Injector Equipment, Complete			1		1								1	1		
- 9	638156-3A2	. Fuel Pump and Vapor Separator Assy.		1	1		1								1	1		
		ATTACHING PARTS																
-10	2473	. Washer, Plain		4	4		4								4	4		
-11	MS35338-45	. Washer, Lock		4	4		4								4	4		
-12	2439	. Nut, Plain, Hex		4	4		4								4	4		
		* * * *																
-13	639268	. Shroud Assembly, Fuel Pump		1			1								1	1		
-13	639266	. Shroud Assembly, Fuel Pump			1													
-14	626879-1	. Grommet, Fuel Pump Shroud		4	4		4								4	4		
-15	534337	. Nut, Tinnerman, Type J		4	4		4								4	4		
-16	AN526-1024-4	. Screw		4	4		4								4	4		
	627315A7	. Throttle and Control Assembly		1														
	627315A3	. Throttle and Control Assembly			1		1								1	1		

FIG. & INDEX	PART NUMBER	DESCRIPTION	QUANTITY PER ASSEMBLY															
			C	D	E	F	G	H	J	K	L	M	N	P	R	S	U	V
64-17	627326A1	. . Throttle and Lever Assembly	1															
-17	627326A2	. . Throttle and Lever Assembly (For detail parts see Figure 65)		1		1								1	1			
-18	625219-2A2	. . Control Assembly, Complete	1															
-18	625219-2A3	. . Control Assembly, Complete		1		1								1	1			
ATTACHING PARTS																		
-19	501867	. . Washer, Tab	3	3		3								3	3			
-20	537629	. . Screw, 1/4-20 X 21/32 Inch Long * * * *	3	3		3								3	3			
	625539A1	. . Link Rod Assembly	1	1		1								1	1			
-21	625539	. . Rod and Link Assembly	1	1		1								1	1			
-22	626634	. . Spring, Compression	1	1		1								1	1			
-23	625542	. . Rod End, Special	1	1		1								1	1			
-24	MS20365-1032A	. . Nut, Elastic Stop	1	1		1								1	1			
-25	625327-2	. . Washer, Wave	2	2		2								2	2			
-26	537690	. . Washer, Plain	2	2		2								2	2			
-27	2500	. . Pin, Cotter	2	2		2								2	2			
	627544A1	. Shroud Assembly, Metering Unit, Complete	1															
	627713A1	. Shroud Assembly, Metering Unit, Complete		1		1								1	1			
-28	627544	. . Shroud Assembly, Bottom	1															
-28	627713	. . Shroud Assembly, Bottom		1		1								1	1			
-29	627545	. . Shroud Assembly, Cover	1															
-29	627734	. . Shroud Assembly, Cover		1		1								1	1			
-30	626879-1	. . Grommet, Injector	2	2		2									2			
-31	537911	. . Nut, Tinnerman, Type J	2	1		1								1	1			
-32	AN526-1024-4	. . Screw	2	1		1								1	1			
-33	626891	. . Grommet, Rubber	2	2		2								2	2			
-34	631427A1	. Valve Assembly, Fuel Manifold (For detail parts see Figure 66)	1	1		1								1	1			
-35	626486	. Bracket, Fuel Discharge Tubes	Rf	Rf		Rf								Rf	Rf			
-36	635158-15.00	. Hose Assembly, Flexible, 1/4 ID X 15 Inches Long	1															
-36	MS28741-4-0150	. Hose Assembly, Flexible, 1/4 ID X 15 Inches Long		1		1								1	1			
-37	635158-17.00	. Hose Assembly, Flexible, 1/4 ID X 17 Inches Long	1															
-37	MS28741-4-0130	. Hose Assembly, Flexible, 1/4 ID X 13 Inches Long		1		1								1	1			
-38	635158-40.00	. Hose Assembly, Flexible, 1/4 ID X 40 Inches Long	1															
-38	MS28741-4-0320	. Hose Assembly, Flexible, 1/4 ID X 32 Inches Long		1		1								1	1			
-39	627335D12 *	. Nozzle Assembly, Fuel Injection	6	6		6								6	6			
-40	628154	. Tube Assembly, Fuel Discharge, No. 1 & 6	2	2		2								2	2			
-40	628153	. Tube Assembly, Fuel Discharge, No. 2 & 5	2	2		2								2	2			
-40	628152	. Tube Assembly, Fuel Discharge, No. 3 & 4	2	2		2								2	2			
-41	626577-2	. Clamp, Fuel Discharge Tube	6	6		6								6	6			
-42	625302-16	. Duct, Flexible, 1 Inch ID X 16 In. Lg.	2	1		1								1	1			
-43	625302-12	. Duct, Flexible, 1 Inch ID X 12 In. Lg.		1		1								1	1			
-44	AN737RM38	. Clamp, Flexible Duct	2	2		2								2	2			
-45	628264	. Clamp, Hose	1			1								1	1			

*Check old nozzle on engine for correct suffix.

FIG. & INDEX	PART NUMBER	DESCRIPTION	QUANTITY PER ASSEMBLY															
			C	D	E	F	G	H	J	K	L	M	N	P	R	S	U	V
65- 4	626813	. . . Pin - Tubular, Lever	1	1	1	1	1	1	1	1	1	1	1	1	1	1	1	1
- 5	625228	. . . Lever - Throttle Control	1	1	1	1	1	1	1	1	1	1	1	1	1	1	1	1
- 5	629329	. . . Lever - Throttle Control															1	1
- 5	629871	. . . Lever - Throttle Control																1
- 5	632556	. . . Lever - Throttle Control																1
- 6	632554-2	. . . Bushing																1
- 7	625457	. . . Washer - Plain	1	1	1	1	1	1	1	1	1	1	1	1	1	1	1	1
- 7	625457-1	. . . Washer - Plain															1	1
	626226-A1	. . . Body Assembly - Air							1									
	626234-A1	. . . Body Assembly - Air	1					1										
	625735-A1	. . . Body Assembly - Air		1	1		1			1			1	1		1	1	1
	626735-A2	. . . Body Assembly - Air										1						
	639437	. . . Body Assembly - Air				1												
	628382-A1	. . . Body Assembly - Air								1								
	628528-A1	. . . Body Assembly - Air											1					
	629324-A1	. . . Body Assembly - Air															1	
- 8	No Number	. . . Body - Air Throttle	ns	ns	ns	ns	ns	ns	ns	ns	ns	ns	ns	ns	ns	ns	ns	ns
- 9	630455	. . . Bushing - Air Throttle	2	2	2	2	2	2		2	2	2	2	2	2	2	2	2
-10	401893	. . . Stud - 1/4 X 1-1/4 in. lg.		2	2		2			2	2		2	2		2	2	2
-10	402711	† . . . Stud - 1/4-20 X 1/4-28 X 7/8 in. lg.															2	
-11	628981	† . . . Stud - 1/4-20 X 1/4-28 X 1-5/16 in. lg.										2						
-12	AN932-2	. . . Plug - Manifold Pressure Boss		1	1		1			1	1		1	1	1	1	1	1
-13	626634	. . . Spring - Idle Adjusting	1	1	1	1	1	1	1	1	1	1	1	1	1	1	1	1
-14	639479	. . . Screw - Idle Adjusting	1	1	1	1	1	1	1	1	1	1	1	1	1	1	1	1
-15	626813	. . . Pin - Tubular, Collar	1	1				1	1	1	1		1				1	1
-16	625238	. . . Collar - Throttle Shaft	1	1				1	1	1	1		1				1	1
-17	625327-1	. . . Washer - Wave				1		1	1	1		1					1	1
-18	625457	. . . Washer - Plain	1			1		1	1	1		1					1	1
-19	626813	. . . Pin - Tubular, Throttle Lever	1	1	1	1	1	1	1	1	1	1	1	1	1	1	1	1
-20	AN501-10-10	. . . Screw - Throttle Lever		1	1		1					1		1	1			
-20	AN501-10-14	. . . Screw - Throttle Lever	1					1	1	1	1		1					
-21	13XX-260	. . . Lockwasher - Throttle Lever	1	1	1		1	1	1	1	1	1	1	1	1			
-22	626910	. . . Lever - Throttle Shaft	1					1	1	1	1		1					
-22	627809	. . . Lever - Throttle Shaft		1														
-22	629418	. . . Lever - Throttle Shaft				1												
-22	628095	. . . Lever - Throttle Shaft			1		1							1	1			
-22	628914	. . . Lever - Throttle Shaft										1						
-22	631818	. . . Lever - Throttle Shaft															1	
-23	625327-1	. . . Washer - Wave		1	1		1			1	1		1	1	1	1	1	1
-24	625457	. . . Washer - Plain		1	1		1			1	1		1	1	1	1	1	1
-25	626586	. . . Screw - Idle Adjusting															1	
-26	626634	. . . Spring - Idle Adjusting															1	
-27	X-604	. . . Pin - Cotter, Throttle Shaft															1	1
-28	2457	. . . Nut - Throttle Shaft															1	1

† See Section III for equivalent under- or oversize parts.

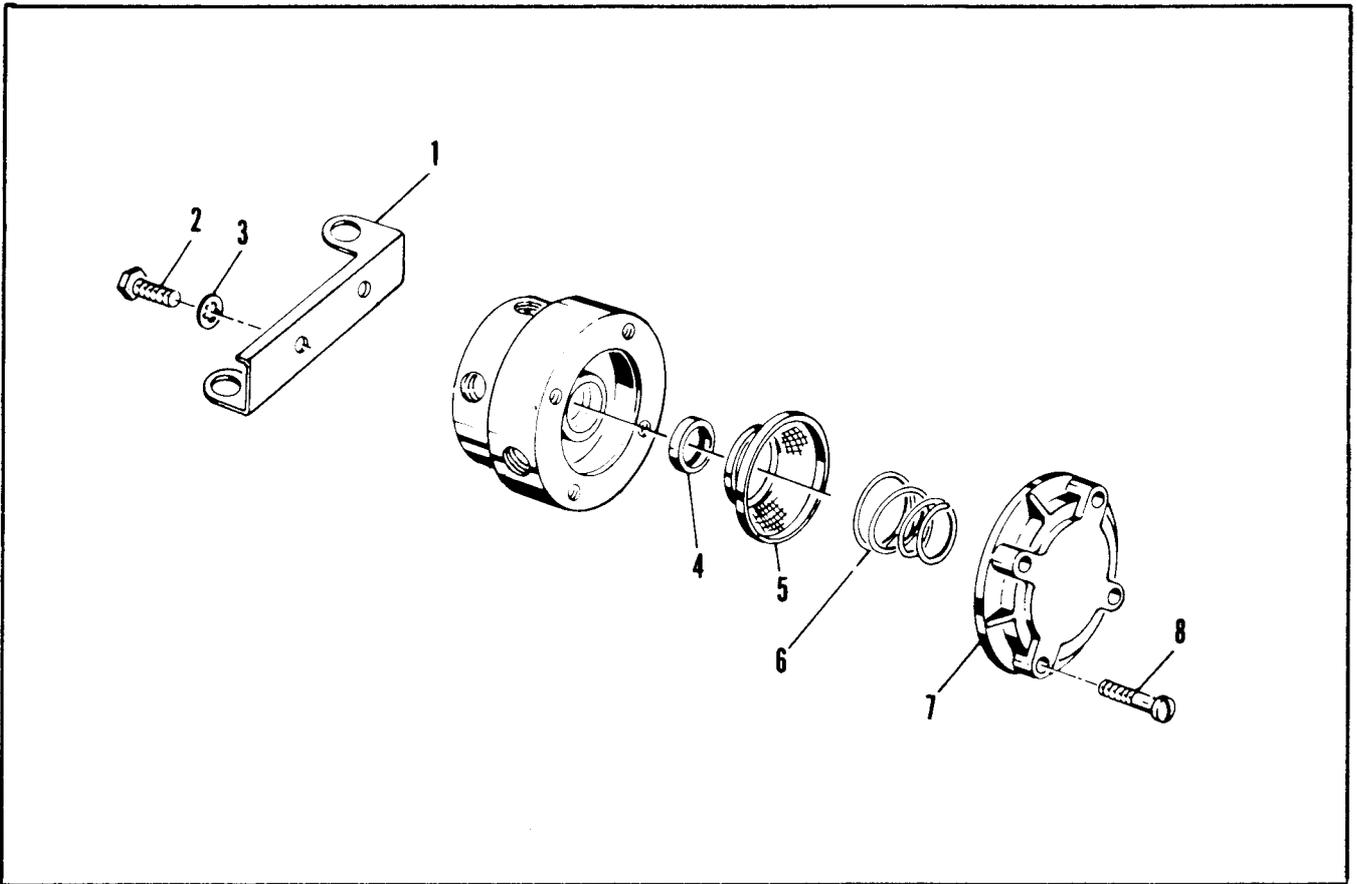

FIGURE 66. FUEL MANIFOLD VALVE
 MODELS 10-470-C, D, E, F, G, H, J, K, L, M, N, P, R, S, U, V

FIG. & INDEX	PART NUMBER	DESCRIPTION	QUANTITY PER ASSEMBLY															
			C	D	E	F	G	H	J	K	L	M	N	P	R	S	U	V
66-	631427A1	Fuel Manifold Valve Assembly	1	1	1	1	1	1	1	1	1	1	1	1	1	1	1	1
	631427A2	Fuel Manifold Valve Assembly											1					
	631427A3	Fuel Manifold Valve Assembly															1	
	631427A11	Fuel Manifold Valve Assembly								1								
	631351A6	Fuel Manifold Valve Assembly																1
- 1	634011	Bracket	1	1	1	1	1	1	1	1	1	1	1	1	1	1	1	1
		ATTACHING PARTS																
- 2	AN500-10-5	Screw	2	2	2	2	2	2	2	2	2	2	2	2	2	2	2	2
- 3	22910	Washer, Lock	2	2	2	2	2	2	2	2	2	2	2	2	2	2	2	2
		* * * *																
- 4	631330	Seal	1	1	1	1	1	1	1	1	1	1	1	1	1	1	1	1
- 5	626557	Screen	1	1	1	1	1	1	1	1	1	1	1	1	1	1	1	1
- 6	627378	Spring	1	1	1	1	1	1	1	1	1	1	1	1	1	1	1	1
- 6	630184	Spring																1
- 7	626553	Cover	1	1	1	1	1	1	1	1	1	1	1	1	1	1	1	1
		ATTACHING PARTS																
- 8	AN500A8-10	Screw	4	4	4	4	4	4	4	4	4	4	4	4	4	4	4	4
		* * * *																

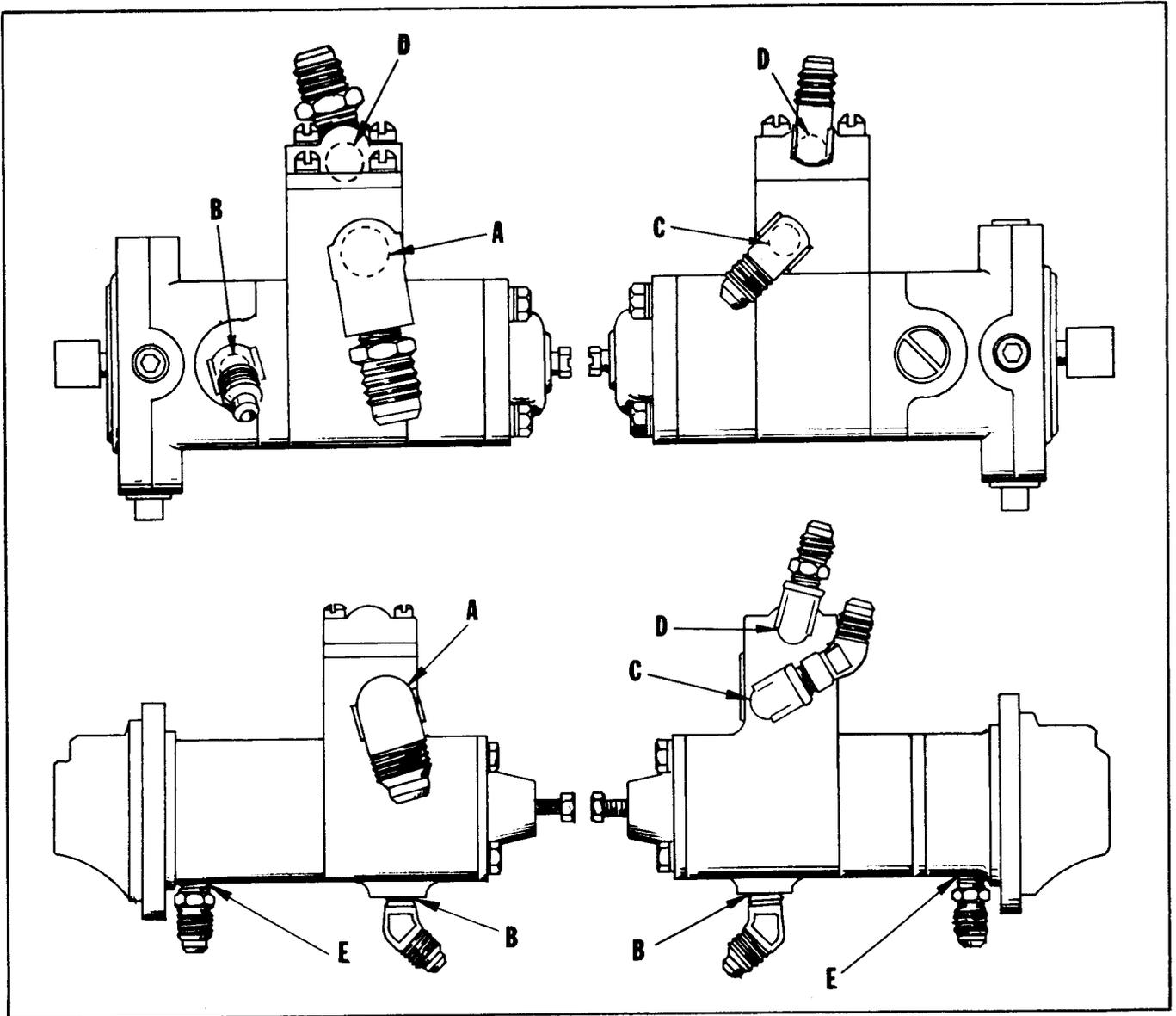

FIGURE 67. FUEL PUMP AND VAPOR SEPARATOR FITTING LOCATIONS.

	Fuel Pump & Vapor Sep. Number	INLET Fitting "A" Number	OUTLET Fitting "B" Number	MIXTURE RETURN Fitting "C" Number	VAPOR RETURN Fitting "D" Number	SEAL DRAIN Fitting "E" Number
IO-470-C, D, E, F, G, H, J, K, N, P, R, U	638156	628475	629267	628478	628476	629518-1
IO-470-L	638156	628475	628438 X12143	628438	628478	629518-1
IO-470-M	638156	AN816-7 AN914-2	630089	628478	627119 AN816-6-2	629518-1
IO-470-S	638156	628475	630089	628478	628476	629518-1
IO-470-V	638154	628475	628436	628478	628476	628438

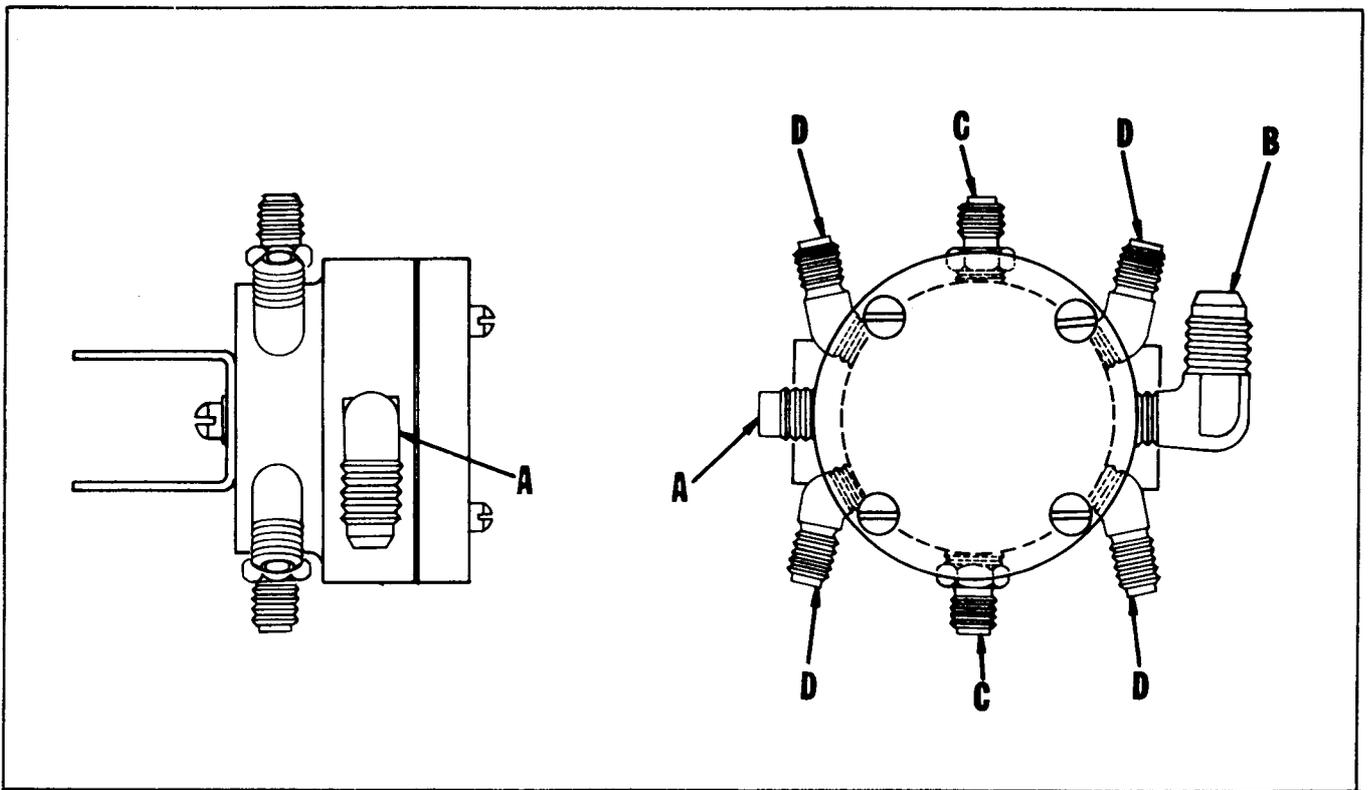

FIGURE 68. FUEL MANIFOLD VALVE FITTING LOCATIONS.

	Fuel Manifold Assembly Number	Fitting "A" Number	Fitting "B" Number	Fitting "C" Number	Fitting "D" Number
IO-470-C, D, E, F, G, H, J, L, N, P, R, U	631427	Plug 629518-1	628437	AN780-2	627331
IO-470-K	631427	631658	628437	AN780-2	627331
IO-470-M	631427	628437	628437	AN780-2	627331
IO-470-S	631427	631720	628437	AN780-2	627331
IO-470-V	631351	631720	628437	AN780-2	627331

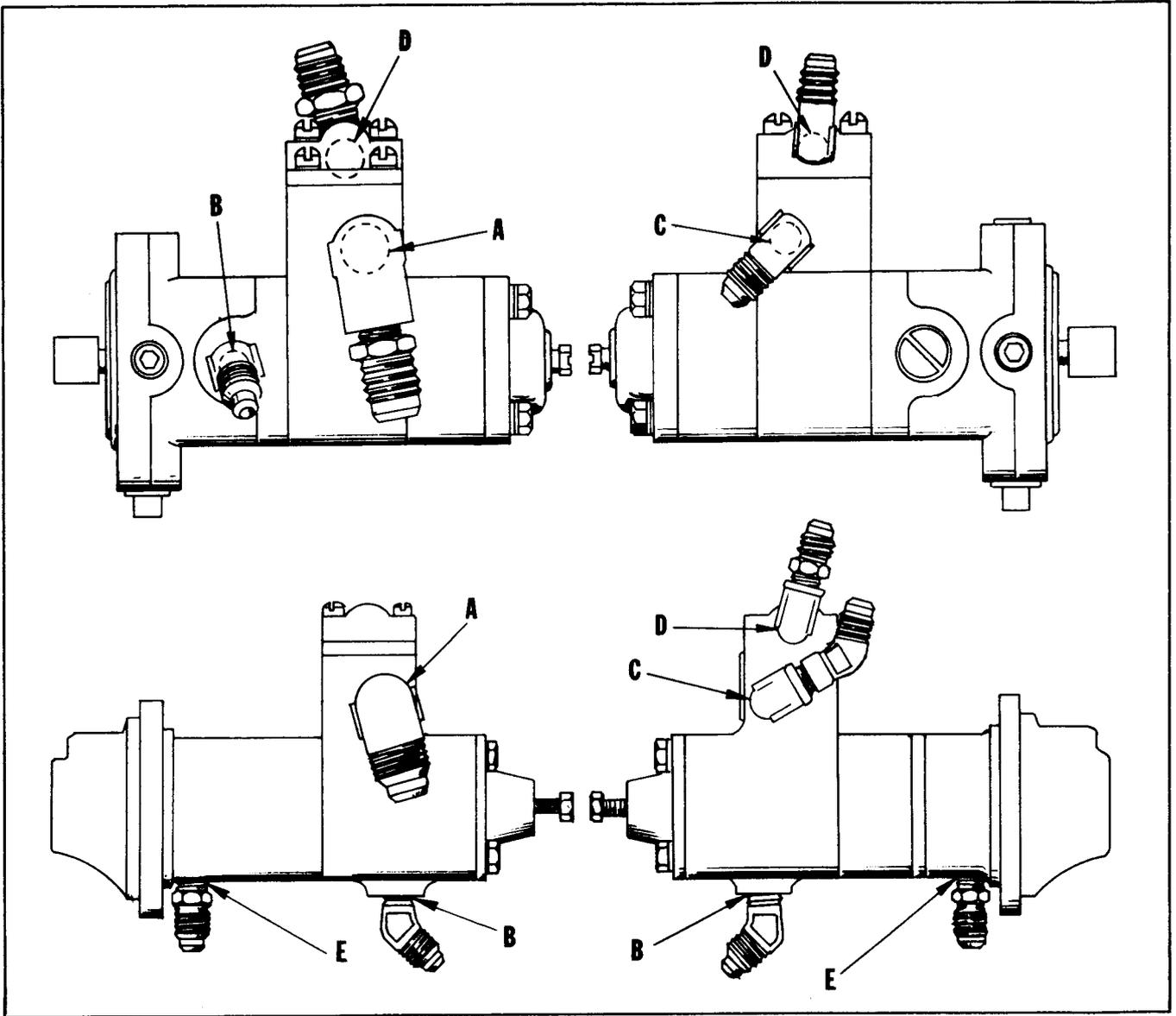

FIGURE 67. FUEL PUMP AND VAPOR SEPARATOR FITTING LOCATIONS.

	Fuel Pump & Vapor Sep. Number	INLET Fitting "A" Number	OUTLET Fitting "B" Number	MIXTURE RETURN Fitting "C" Number	VAPOR RETURN Fitting "D" Number	SEAL DRAIN Fitting "E" Number
IO-470-C, D, E, F, G, H, J, K, N, P, R, U	638156	628475	629267	628478	628476	629518-1
IO-470-L	638156	628475	628438 X12143	628438	628478	629518-1
IO-470-M	638156	AN816-7 AN914-2	630089	628478	627119 AN816-6-2	629518-1
IO-470-S	638156	628475	630089	628478	628476	629518-1
IO-470-V	638154	628475	628436	628478	628476	628438

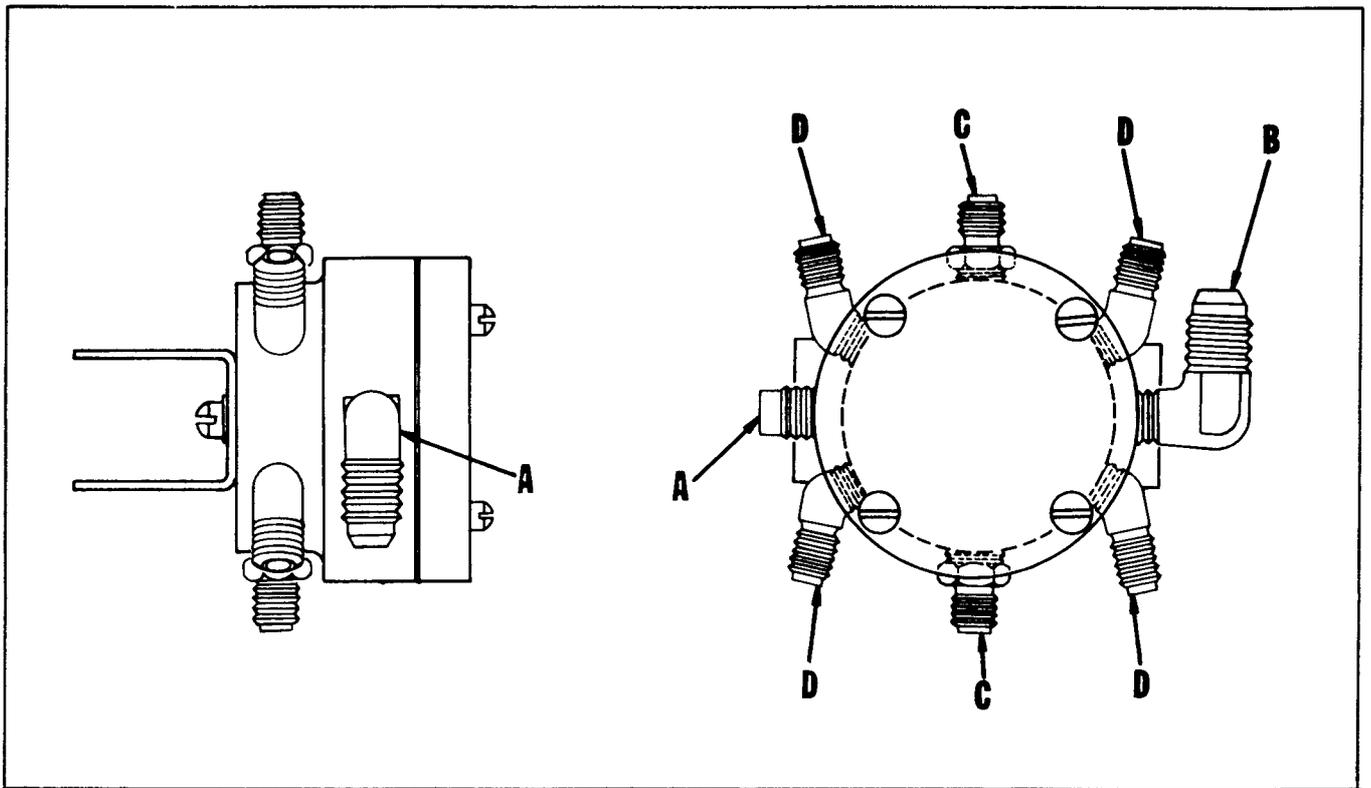

FIGURE 68. FUEL MANIFOLD VALVE FITTING LOCATIONS.

	Fuel Manifold Assembly Number	Fitting "A" Number	Fitting "B" Number	Fitting "C" Number	Fitting "D" Number
IO-470-C, D, E, F, G, H, J, L, N, P, R, U	631427	Plug 629518-1	628437	AN780-2	627331
IO-470-K	631427	631658	628437	AN780-2	627331
IO-470-M	631427	628437	628437	AN780-2	627331
IO-470-S	631427	631720	628437	AN780-2	627331
IO-470-V	631351	631720	628437	AN780-2	627331

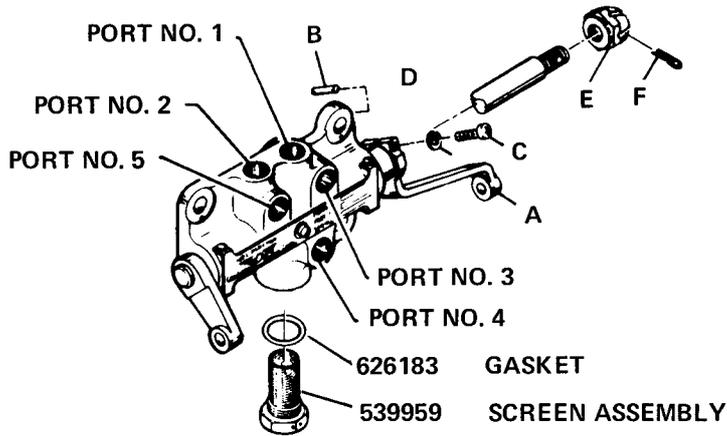

FIGURE 69. FUEL CONTROL FITTING LOCATIONS.

Model IO-470	Control Assy Fuel Inj. P/N	Port No. 1 Fitting No.	Port No. 2 Fitting No.	Port No. 3 Fitting No.	Port No. 4 Fitting No.	Port No. 5 Fitting No.	Mixture Control Lever "A" No.	Pin Mixture Lever "B" No.	Screw Mixture Lever "C" No.	Lockwasher Mixture Lever "D" No.	Lockwasher Mixture Lever "E" No.	Cotter-Pin Mixture Shaft "F" No.
C-H-N	625219-2	627119 628437	626900 628437	AN932C2	628437	627119 626900 628434	626910	626813	AN502-10-14	13XX260		
D	625219-2	627119 628437	628476	AN932-2	627642 2024 628438	626900 628434	627590	626813	AN501-10-10	13XX260		
E-G-P- R	625219-2	627119 628437	626900 628434	AN932C2	628437	628437	629111	626813				
F	625219-2	630119 628476	628437	AN932C2	628437	AN932C2	627590	626813	AN501-10-10	13XX260		
J	625219-1	627119 628437	626900 628437	AN932C2	628437	627119 626900 628434	626910	626813	AN502-10-14	13XX260		
K	625219-1	627119 628437	628437 626900	AN932-2	628437	AN932-2	626910	626813	AN502-10-14	13XX260		
L	625219-2	X12470 627119 628438	628437	AN932C2	628437	AN932C2	626910	626813	AN501-10-14	13XX260		
M	629219-2	630119 627119 628478	628437	AN932C2	627642 2024 628438	AN932C2	627590	626813	AN501-10-10	13XX260		
S	629703-2	627119 630119 628437	AN932C2	AN932C2	630119 628478	628438	629351	626813-1				
U	632904-2	627119 628437	628476	AN932C2	627642 2024 628438	626900 628434					2457	X-604
V	632916-2	633343 628437	628437	AN932-2	628438 2024 634195	AN932-2					2457	X-604

SECTION III

OVERSIZE AND UNDERSIZE PARTS LIST

PART NO.	NAME	DESCRIPTION	PART NO.	NAME	DESCRIPTION
22319P003	Stud	.003" OS on PD	401806P003	Stud	.003" OS on PD
22319P006	Stud	.006" OS on PD	401806P007	Stud	.007" OS on PD
22319P009	Stud	.009" OS on PD	401806P012	Stud	.012" OS on PD
22320P003	Stud	.003" OS on PD	401808P003	Stud	.003" OS on PD
22320P006	Stud	.006" OS on PD	401808P007	Stud	.007" OS on PD
22320P009	Stud	.009" OS on PD	401808P012	Stud	.012" OS on PD
22324P003	Stud	.003" OS on PD	401809P003	Stud	.003" OS on PD
22324P006	Stud	.006" OS on PD	401809P007	Stud	.007" OS on PD
22324P009	Stud	.009" OS on PD	401809P012	Stud	.012" OS on PD
25008P003	Stud	.003" OS on PD	401814P003	Stud	.003" OS on PD
25008P006	Stud	.006" OS on PD	401814P007	Stud	.007" OS on PD
25008P009	Stud	.009" OS on PD	401814P012	Stud	.012" OS on PD
350998P0015	Bushing-C/wgt	.0015" OS on OD	401816P003	Stud	.003" OS on PD
350998P003	Bushing-C/wgt	.003" OS on OD	401816P007	Stud	.007" OS on PD
350998P005	Bushing-C/wgt	.005" OS on OD	401816P012	Stud	.012" OS on PD
35966P005	Insert	.005" OS on OD	401819P003	Stud	.003" OS on PD
35966P010	Insert	.010" OS on OD	401819P007	Stud	.007" OS on PD
35966P015	Insert	.015" OS on OD	401819P012	Stud	.012" OS on PD
35966P020	Insert	.020" OS on OD	401824P003	Stud	.003" OS on PD
35966P030	Insert	.030" OS on OD	401824P007	Stud	.007" OS on PD
35967P005	Insert	.005" OS on OD	401824P012	Stud	.012" OS on PD
35967P010	Insert	.010" OS on OD	401830P003	Stud	.003" OS on PD
35967P015	Insert	.015" OS on OD	401830P007	Stud	.007" OS on PD
35967P020	Insert	.020" OS on OD	401830P012	Stud	.012" OS on PD
35967P030	Insert	.030" OS on OD			
401801P003	Stud	.003" OS on PD	401841P003	Stud	.003" OS on PD
401801P007	Stud	.007" OS on PD	401841P007	Stud	.007" OS on PD
401801P012	Stud	.012" OS on PD	401841P012	Stud	.012" OS on PD
401804P003	Stud	.003" OS on PD	401852P003	Stud	.003" OS on PD
401804P007	Stud	.007" OS on PD	401852P007	Stud	.007" OS on PD
401804P012	Stud	.012" OS on PD	401852P012	Stud	.012" OS on PD

PART NO.	NAME	DESCRIPTION	PART NO.	NAME	DESCRIPTION
401860P003	Stud	.003" OS on PD	402066P003	Stud	.003" OS on PD
401860P007	Stud	.007" OS on PD	402066P007	Stud	.007" OS on PD
401860P012	Stud	.012" OS on PD	402066P012	Stud	.012" OS on PD
401861P003	Stud	.003" OS on PD	402127P003	Stud	.003" OS on PD
401861P007	Stud	.007" OS on PD	402127P007	Stud	.007" OS on PD
401861P012	Stud	.012" OS on PD	402127P012	Stud	.012" OS on PD
401870P003	Stud	.003" OS on PD	402129P003	Stud	.003" OS on PD
401870P007	Stud	.007" OS on PD	402129P007	Stud	.007" OS on PD
401870P012	Stud	.012" OS on PD	402129P012	Stud	.012" OS on PD
401881P003	Stud	.003" OS on PD	402151P003	Stud	.003" OS on PD
401881P007	Stud	.007" OS on PD	402151P007	Stud	.007" OS on PD
401881P012	Stud	.012" OS on PD	402151P012	Stud	.012" OS on PD
401885P003	Stud	.003" OS on PD	402153P003	Stud	.003" OS on PD
401885P007	Stud	.007" OS on PD	402153P007	Stud	.007" OS on PD
401885P012	Stud	.012" OS on PD	402153P012	Stud	.012" OS on PD
401886P003	Stud	.003" OS on PD	402162P003	Stud	.003" OS on PD
401886P007	Stud	.007" OS on PD	402162P007	Stud	.007" OS on PD
401886P012	Stud	.012" OS on PD	402162P012	Stud	.012" OS on PD
401893P003	Stud	.003" OS on PD	402711P003	Stud	.003" OS on PD
401893P007	Stud	.007" OS on PD	402711P007	Stud	.007" OS on PD
401893P012	Stud	.012" OS on PD	402711P012	Stud	.012" OS on PD
401895P003	Stud	.003" OS on PD	515152P005	Guide - Valve	.005" OS on OD
401895P007	Stud	.007" OS on PD	515152P010	Guide - Valve	.010" OS on OD
401895P012	Stud	.012" OS on PD	515152P015	Guide - Valve	.015" OS on OD
401945P003	Stud	.003" OS on PD	515152P020	Guide - Valve	.020" OS on OD
401945P007	Stud	.007" OS on PD	530383M010	Bearing - C/rod	.010" US on ID
401945P012	Stud	.012" OS on PD	530386M010	Bearing - C/shaft	.010" US on ID
401963P003	Stud	.003" OS on PD	531649P003	Stud	.003" OS on PD
401963P007	Stud	.007" OS on PD	531649P006	Stud	.006" OS on PD
401963P012	Stud	.012" OS on PD	531649P009	Stud	.009" OS on PD
401965P003	Stud	.003" OS on PD	532507P003	Stud	.003" OS on PD
401965P007	Stud	.007" OS on PD	532507P006	Stud	.006" OS on PD
401965P012	Stud	.012" OS on PD	532507P009	Stud	.009" OS on PD
401971P003	Stud	.003" OS on PD	534895P015	Piston	.015" OS on OD
401971P007	Stud	.007" OS on PD	535661P020	Camshaft	.020" OS on OD
401971P012	Stud	.012" OS on PD	535956P003	Stud	.003" OS on PD
402042P003	Stud	.003" OS on PD	535956P006	Stud	.006" OS on PD
402042P007	Stud	.007" OS on PD	535956P009	Stud	.009" OS on PD
402042P012	Stud	.012" OS on PD	536563P005	Dowel - C/shaft	.005" OS on OD
402056P003	Stud	.003" OS on PD			
402056P007	Stud	.007" OS on PD			
402056P012	Stud	.012" OS on PD			

PART NO.	NAME	DESCRIPTION	PART NO.	NAME	DESCRIPTION
536938P005	Ring - Piston	.005" OS on OD	630591P005	Insert	.005" OS on OD
536938P015	Ring - Piston	.015" OS on OD	630591P010	Insert	.010" OS on OD
			630591P015	Insert	.015" OS on OD
536939P005	Ring - Piston	.005" OS on OD	630591P020	Insert	.020" OS on OD
536939P015	Ring - Piston	.015" OS on OD	630591P030	Insert	.030" OS on OD
			631481P015	Piston	.015" OS on OD
537341P015	Spring - Clutch	.015" US on ID			
			631496P005	Guide - Valve	.005" OS on OD
537422P003	Stud	.003" OS on PD	631496P010	Guide - Valve	.010" OS on OD
537422P006	Stud	.006" OS on PD	631496P015	Guide - Valve	.015" OS on OD
537422P009	Stud	.009" OS on PD	631496P020	Guide - Valve	.020" OS on OD
			631496P030	Guide - Valve	.030" OS on OD
537883P015	Piston	.015" OS on OD			
			631501P005	Ring - Piston	.005" OS on OD
539467P005	Pin - Piston	.005" OS on OD	631501P015	Ring - Piston	.015" OS on OD
539800M015	Spring - Clutch	.015" US on ID	632040P005	Ring - Piston	.005" OS on OD
			632040P015	Ring - Piston	.015" OS on OD
539814P015	Piston	.015" OS on OD			
			632319M010	Bearing - C/shaft	.010" US on ID
625147P005	Ring - Piston	.005" OS on OD			
625147P015	Ring - Piston	.015" OS on OD	632355P005	Ring - Piston	.005" OS on OD
			632355P015	Ring - Piston	.005" OS on OD
626739M010	Collar - C/Shaft	.010" US on ID			
			632932P015	Piston	.015" OS on OD
626992P015	Piston	.015" OS on OD			
			633136M010	Bearing - C/shaft	.010" US on ID
627480P005	Ring - Piston	.005" OS on OD			
627480P015	Ring - Piston	.015" OS on OD	633317P005	Ring - Piston	.005" OS on OD
			633317P015	Ring - Piston	.015" OS on OD
627738P015	Piston	.015" OS on OD			
			635095P005	Ring - Piston	.005" OS on OD
628198M010	Collar - C/shaft	.010" US on ID	635095P015	Ring - Piston	.015" OS on OD
628750M010	Bearing - C/rod	.010" US on ID	635557P005	Ring - Piston	.005" OS on OD
			635557P015	Ring - Piston	.015" OS on OD
628754P005	Ring - Piston	.005" OS on OD	639193P0015	Bushing - C/wgt	.0015" OS on OD
628754P015	Ring - Piston	.015" OS on OD	639193P003	Bushing - C/wgt	.003" OS on OD
			639193P005	Bushing - C/wgt	.005" OS on OD
628981P003	Stud	.003" OS on PD			
628981P006	Stud	.006" OS on PD	639565P005	Ring - Piston	.005" OS on OD
628981P009	Stud	.009" OS on PD	639565P015	Ring - Piston	.015" OS on OD
628985P005	Ring - Piston	.005" OS on OD	639566P005	Ring - Piston	.005" OS on OD
628985P015	Ring - Piston	.015" OS on OD	639566P015	Ring - Piston	.015" OS on OD
629848M010	Bearing - C/shaft	.010" US on ID	639663P005	Ring - Piston	.005" OS on OD
			639663P015	Ring - Piston	.015" OS on OD
630464M010	Bearing - C/shaft	.010" US on ID	640518P015	Piston	.015" OS on OD

SECTION IV

REPAIR PARTS SETS AND MATERIALS

Part Number	Description	Qty. Per Assy	Application
BEARING SETS * (THRUST WASHER TYPE)			
† 633136A1	Consists of the following:	1	O-470-E-J-K-L-T-S
† 633136	Bearing - Front Thrust	1	
† 530386	Bearing - Intermediate and Rear	6	
628136	Washer - Top and Bottom Thrust	4	
† 633136A2	Consists of the following:	1	O-470-B-M-N
† 633136	Bearing - Front Thrust	2	
† 630464	Bearing - Intermediate and Rear	6	
628136	Washer - Top and Bottom, Thrust	4	
† 630464A5	Consists of the following:	1	IO-470-C-D-E- F-G-H-J-
† 530386	Bearing - Front Thrust	2	K-L-M-N-R-S-U-V,
† 630464	Bearing - Intermediate and Rear	8	O-470-G-P
628136	Washer - Top and Bottom, Thrust	4	
† 630464A6	Consists of the following:	1	IO-470-P
† 632319	Bearing - Front Thrust	2	
† 629848	Bearing - Front Main	2	
† 630464	Bearing - Intermediate and Rear	6	
BEARING SETS * (FLANGE BEARING TYPE)			
† 537401A1	Consists of the following:	1	O-470-A-E-J-K-L-R-S
† 537401	Bearing - Front Thrust	2	
† 530386	Bearing - Intermediate and Rear	6	
† 538879A1	Consists of the following:	1	O-470-B-M
† 538879	Bearing - Front Thrust	2	
† 630464	Bearing - Intermediate and Rear	6	
538877	Packing - Bearing Seal	4	
†** 627795A1	Consists of the following:	1	IO-470-D-E-F- H-L-M-N-S-
† 627795	Bearing - Front Thrust	2	U-V
† 530386	Bearing - Front Main	2	
† 630464	Bearing - Front and Rear Intermediate	4	
† 630464	Bearing - Rear Silver	2	
626740	Washer - Top and Bottom Thrust	2	
626741	Washer - Top and Bottom Thrust	2	
† 627795A2	Consists of the following:	1	O-470-P, IO-470-C-G-
† 627795	Bearing - Front Thrust	2	J-K-R
† 538897	Bearing - Rear Main	2	
† 537848	Bearing - Intermediate	4	
† 530386	Bearing - Front Main	2	
626740	Washer - Top and Bottom Thrust	2	
626741	Washer - Top and Bottom Thrust	2	

* Refer to Service Bulletin M66-4 for different crankcase, crankshaft and bearing applications.

Part Number	Description	Qty. Per Assy	Application
RING SETS			
639566A1	Consists of the following:	1	O-470-G, IO-470-C-
639566	Ring - First and Second Grooves	2	G-P-R
639768	Ring - Third Groove	1	
628985A3	Consists of the following:	1	IO-470-D-E-F-H-L-
628985	Ring - First Groove	1	M-N-S-U
639566	Ring - Second Groove	1	
639768	Ring - Third Groove	1	
627480	Ring - Fourth Groove	1	
639565A6	Consists of the following:	1	IO-470-D-E-F-H-L-
639565	Ring - First Groove	1	M-N-S-U-V
639566	Ring - Second Groove	1	
639663	Ring Assembly - Third Groove	1	
627480	Ring - Fourth Groove	1	
639567A11	Consists of the following:	1	O-470-K-L-R
639567	Ring - First Groove	1	(632932 Piston)
639568	Ring - Second Groove	1	
639663	Ring - Third Groove	1	
627480	Ring - Fourth Groove	1	
639567A9	Consists of the following:	1	O-470-A-B-E-J-M-P-
639567	Ring - First Groove	1	IO-470-C-G-J-K-P-R
639568	Ring - Second Groove	1	
639768	Ring - Third Groove	1	
639567A10	Consists of the following:	1	O-470-K-L-R
639567	Ring - First Groove	1	(626992 Piston)
639568	Ring - Second Groove	1	
639768	Ring - Third Groove	1	
627480	Ring - Fourth Groove	1	
RING SETS FOR CHROME PLATED CYLINDERS			
639723	Consists of the following:		
640299	Ring - First and Second Grooves	2	O-470-J-K-L-M-P
640300	Ring - Third Groove	1	IO-470-J-K
639726	Consists of the following:		
640301	Ring - First and Second Grooves	2	O-470-G, IO-470-C-G-P-R
640300	Ring - Third Groove	1	
639729	Consists of the following:		
640301	Ring - First and Second Grooves	2	IO-470-D-E-F-H-L-M-N-
640300	Ring - Third Groove	1	S-U-V
640302	Ring - Fourth Groove	1	

Part Number	Description	Qty. Per Assy	Application
639734	Consists of the following:		
640299	Ring - First and Second Grooves	2	O-470-K-L-R
640300	Ring - Third Groove	1	
640302	Ring - Fourth Groove	1	
639732*	Consists of the following:		
640301	Ring - First and Second Grooves	2	IO-470-D-V
639663	Ring - Third Groove	1	
640302	Ring - Fourth Groove	1	

* For use with piston P/N 631481

GASKETS SETS *

536092A1	Consists of the following:	1	O-470-A-E-J
AN900-10	Gasket	4	
AN900-15	Gasket	1	
AN900-14	Gasket	1	
AN900-18	Gasket	1	
AN900-28	Gasket	1	
AN4045-1	Gasket	2	
AN123860	O-Ring	1	
AN123862	O-Ring	3	
AN123861	O-Ring	1	
640087	Seal	1	
21493	Gasket	6	
25102	Seal	2	
35985	Gasket	2	
531083	Gasket	1	
536740	Seal	6	
532200	Packing	6	
532451	Gasket	6	
MS9021-038	O-Ring	1	
534316	Gasket	1	
534610	Packing	12	
534740	Gasket	1	
534743	Gasket	1	
625303	Gasket	1	
534750	Gasket	2	
537749	Gasket	2	
537745	Gasket	1	
534863	Gasket	2	
538185	Gasket	1	
534938	Seal	1	
534940	Gasket	1	
534941	Gasket	1	
536410	Packing	12	
639660-11	Hose	8	
535832	Hose	2	
538804	Gasket	1	
25135	Gasket	1	
635134	Gasket	1	

* 100% Replacement Parts.

Part Number	Description	Qty. Per Assy	Application
536092A2	Same as 536092A1 except as follows:	1	O-470-B-M, IO-470-D-F-M-U-V
	Additions		
AN4045-1	Gasket	1	
AN4059-1	Gasket	2	
531378	Seal	1	
534610	Packing	24	
534857	Gasket	6	
534956	Seal	2	
536413	Gasket	6	
537282	Gasket	1	
626342	Gasket	1	
537379	Gasket	6	
AN123965	O-Ring	1	
639660-11	Hose	10	
627368	Gasket	1	
	Omissions		
AN900-15	Gasket	1	
21163	Seal	1	
21493	Gasket	6	
532451	Gasket	6	
534610	Packing	12	
536410	Packing	12	
536740	Seal	6	
535832	Hose	8	
536092A3	Same as 536092A1 except as follows:	1	O-470-K-L-R
	Additions		
537379	Gasket	6	
534857	Gasket	6	
534610	Packing	24	
536413	Gasket	6	
625017	Gasket	1	
639660-11	Hose	10	
	Omissions		
21493	Gasket	6	
532451	Gasket	6	
534610	Packing	12	
536410	Packing	12	
536740	Seal	6	
639660-11	Hose	8	
536092A4	Same as 536092A1 except as follows:	1	IO-470-J-k
	Additions		
AN4059-1	Gasket	2	
AN123865	O-Ring	1	
AN123965	O-Ring	1	
534956	Seal	1	
639660-11	Hose	1	
625017	Gasket	6	
632837	Gasket	2	

* 100% Replacement Parts.

Part Number	Description	Qty. Per Assy	Application
536092A4 (Continued)			
	Ommissions		
AN900-10	Gasket	2	
AN900-15	Gasket	1	
21493	Gasket	6	
25135	Gasket	1	
35985	Gasket	1	
534316	Gasket	1	
535832	Hose	2	
626049A1	Consists of the following:	1	O-470-G-P, IO-470-C- E-G-H-L-N-P-R-S-T
AN900-10	Gasket	4	
AN900-14	Gasket	2	
AN900-18	Gasket	1	
AN900-28	Gasket	1	
AN4045-1	Gasket	3	
AN4059-1	Gasket	2	
AN123860	O-Ring	1	
AN123861	O-Ring	1	
AN123862	O-Ring	3	
AN123865	O-Ring	1	
AN123965	O-Ring	1	
20705-1	Tite-Seal	1	
640087	Seal	1	
25102	Seal	2	
35985	Gasket	2	
531083	Gasket	1	
532200	Packing	6	
532364-.50	Felt	2	
534316	Gasket	1	
MS9021-038	O-Ring	1	
534610	Packing	24	
534740	Gasket	1	
534743	Gasket	1	
534750	Gasket	2	
534857	Gasket	6	
534863	Gasket	2	
534938	Seal	1	
534940	Gasket	1	
534941	Gasket	1	
534956	Seal	1	
535885	Gasket	1	
536413	Gasket	6	
537282	Gasket	1	
537379	Gasket	6	
537745	Gasket	1	
537749	Gasket	1	
538185	Gasket	1	
538804	Gasket	1	
639660-11	Hose	10	

* 100% Replacement Parts.

Part Number	Description	Qty. Per Assy	Application
626049A1 (Continued)			
625017	Gasket	1	
625303	Gasket	1	
627368	Gasket	1	
630350	Gasket	1	
632085	Gasket	1	
635134	Gasket	1	
* 100% Replacement Parts			

GASKET PASTE

20705-1	Tite-Seal - 1 oz. Tube	AR	All Models
---------	------------------------	----	------------

LOCKWIRE

535011	0.040 Inch Dia. Steel	Per foot	All Models
--------	-----------------------	----------	------------

ENAMELS AND PAINTS

531010-1	Enamel - Black, 1 Quart	AR	
531010-2	Enamel - Black, 1 Gallon	AR	
531011-1	Enamel - Grey, 1 Quart	AR	
531011-2	Enamel - Grey, 1 Gallon	AR	
538641-1	Paint - Green, 1 Quart	AR	
538641-2	Paint - Green, 1 Gallon	AR	
626531-1	Enamel - Gold, 1 Quart	AR	
626531-2	Enamel - Gold, 1 Gallon	AR	

SECTION V NUMERICAL PARTS LIST

PART NUMBER	FIG. & INDEX	PART NUMBER	FIG. & INDEX	PART NUMBER	FIG. & INDEX
**	05-40	AN5-16A	29-05	AN75A15	29-14
	06-38	AN5-17A	30-05		50-03
AN101217	28-07		31-05		50-11
AN101218	28-07	AN500-10-5	66-02		51-27
AN123860	05-41	AN500A10-4	03-04	AN75A26	50-08
	06-39		04-04	AN75A6	28-10
AN123862	03-17	AN500A416-8	05-29		29-09
	04-18		06-24		30-10
	26-41	AN500A8-10	06-08		31-10
	27-32	AN501-10-10	65-20	AN78-10	07-23
AN123865	05-38	AN501-10-14	65-20	AN780-2	49-21
	06-36	AN501-10-8	40-33	AN805-2	49-06
AN123866	01-35	AN515-8-6	39-31	AN900-10	01-23
	02-35		41-36		02-24
AN123961	03-14	AN516-1024-1	62-16		20-11
AN123965	08-18	AN520-416-12	50-49		21-19
	09-20		51-23		22-24
AN126132	02-09		54-19		22-32
AN315-5R	28-08	AN526-1024-1	41-39	AN900-12	20-11
AN316-9	26-45		57-16	AN900-14	22-20
	27-36	AN526-1024-4	43-28		22-24
AN320-9	26-45		58-16		22-28
AN364-428	51-32		59-16		24-20
	54-32		61-16		24-24
AN381-3-18	26-48		63-17		24-28
AN4-26A	51-31		63-33	AN900-15	23-10
	54-31		64-16	AN900-18	22-12
	56-29		64-32		24-12
AN4-27A	54-31	AN530-10-6	49-13	AN900-28	22-50
AN4-7A	56-21		49-18		24-50
AN4022-1	49-09	AN6230-26	07-06	AN932-2	22-07
AN4045-1	25-24	AN737RM38	63-45		26-14
AN4059-1	57-07		64-44		65-12
	58-07	AN737TW26	55-16	AN936A516	05-35
	59-07		54-25	AN960-A166	26-36
	60-07		56-14	AN960-10L	05-24
	61-07	AN737TW82	53-08		06-19
	62-07	AN74A3	20-05	AN960-516L	21-09
	63-08		20-05	AN960-816L	07-24
	64-07		21-05	AN960C916	26-47
AN5-10A	28-05		21-05		27-38
AN5-12A	03-21	AN74A4	20-03	A24814	14-
	04-22		20-03		15-
AN5-13A	03-20		21-03	A24815	14-
	04-21		21-03		15-
AN5-14A	03-21	AN75-16	31-06	A36121	18-
	04-22	AN75A10	30-15	MS122121	14-05
AN5-15A	29-06		31-17		15-05
	30-06				16-05
					17-05

PART NUMBER	FIG. & INDEX	PART NUMBER	FIG. & INDEX	PART NUMBER	FIG. & INDEX
MS122122	01-29		36-03		55-25
	02-30		36-09		57-11
	21-15		37-03		58-11
MS122162	01-29		38-04		59-11
	02-30		50-36		60-11
MS20073-04-10	22-44		50-48		61-11
MS20365-1032A	40-35		51-07		62-11
	57-24		51-22		63-12
	58-24		52-14		64-11
	59-24		53-22	MS35338-46	03-18
	60-22		53-37		04-19
	61-24		54-06		06-05
	62-24		54-20		21-22
	63-25		54-45		37-10
	64-24		55-06		38-11
MS28741-4-0044	58-36		55-34	MS35756-8	10-08
MS28741-4-0084	58-35		56-05		11-07
MS28741-4-0130	64-37		56-20		26-21
MS28741-4-0150	64-36		56-28		26-44
MS28741-4-0160	58-34		56-34		27-16
	61-34		58-30		27-35
MS28741-4-0170	60-32		60-28	MS9021-038	26-04
MS28741-4-0180	62-37		61-30		27-04
MS28741-4-0266	59-34		62-32	MS9134-01	23-27
	57-35	MS35338-45	03-12		37-05
MS28741-4-0300	57-36		03-23		38-06
	59-36		04-12	MS9137-01	19-05
MS28741-4-0320	64-38		04-24	M330S208	56-24
MS28741-4-0330	62-38		05-15	Q9S552-06	22-45
MS28741-4-0340	57-34		05-20		24-45
	59-35		06-15	Q9T116-07	22-47
	60-33		06-27		24-47
MS28741-4-0370	61-35		06-33	Q9T116-218	22-43
MS35303-36	53-10		14-20		24-43
MS35338-44	05-09		15-20	WE1017	45-06
	05-28A		19-03		46-15
	06-09		26-09		47-06
	14-30		26-35	WE365	45-06
	15-30		27-08		47-06
	16-31		27-25		48-06
	17-31		30-16	WE502	46-13
	22-02		37-07	WE565	46-08
	23-03		38-08		47-16
	23-16		39-03	WE626	46-07
	23-30		40-03		47-15
	24-02		41-03	WE630	47-14
	25-03		42-03	WE678	46-06
	25-12		43-03	X-604	65-27
	25-27		50-21	X13041	26-19
	26-35		51-41		27-14
	33-03		51-46	X1454	08-24
	34-03		52-05		09-26
	34-10		52-23	X1473	22-14
	35-03		53-04		24-14
	35-11		54-38	X1794B	08-05

PART NUMBER	FIG. & INDEX	PART NUMBER	FIG. & INDEX	PART NUMBER	FIG. & INDEX
13XX-260	65-21		55-07		55-31
13XX1896	05-26		55-35		56-22
	05-50		56-06		56-30
	06-21		58-29	2274	07-05
13XX202B	20-09		60-27	22904	05-47
	21-08		61-29		06-45
	50-44		62-31	22910	05-49
	54-41	20527	39-30		06-20
	55-18		41-37		06-47
	55-22	20654	05-25		23-25
13XX299	26-46	20655	23-26		25-22
	27-37		25-23		40-34
20087	39-16	20720	49-07		66-03
	41-21	20882	52-02	23890	56-33
	43-20	21007	14-24	24239	03-16
2024	14-08		14-27		04-17
	21-16		15-24	2437	05-10
	24-07		15-27		06-10
	49-20		16-22		22-01
2025	01-26		16-25		23-04
	02-27		17-22		23-17
2026	34-07		17-25		23-31
	35-07	21163	25-09		24-01
	36-06	21208A1	23-11		25-04
	36-16		25-07		25-13
20274	20-12	21213	31-16		25-28
20522	14-31	21247	16-39		33-02
	15-31		17-39		34-05
	16-32		39-25		34-09
	17-32	21440	45-13		35-05
	20-04	21493	14-34		35-10
	21-04		15-34		36-08
	22-03	21512	49-08		37-02
	23-02	22022	14-33		38-02
	23-15		15-33		53-38
	24-03	22319	02-07		54-44
	25-02	22320	01-10		55-33
	25-02	22324	01-13		56-19
	25-11	22366	07-26		56-27
	26-32	22533	21-09		58-31
	33-04		52-06		60-29
	34-04		52-24		61-31
	34-11		53-05		62-33
	35-04	22535	05-13	2439	03-24
	35-12		06-13		04-25
	36-04	22537	26-33		05-16
	36-10	2265	21-18		05-21
	50-18	22661	29-12		06-16
	50-37		30-13		06-29
	51-06		31-13		19-02
	51-36		32-20		26-08
	52-15		50-17		27-07
	53-23		51-37		29-08
	54-07		52-19		30-09
	54-46		53-32		31-09

PART NUMBER	FIG. & INDEX	PART NUMBER	FIG. & INDEX	PART NUMBER	FIG. & INDEX
	32-13		06-34		61-27
	37-06		14-21		62-27
	38-07		15-21		63-28
	39-02		16-28		64-27
	40-02		17-28	25008	38-16
	41-02		19-04	25102	37-16
	42-02		20-10		38-17
	43-02		21-09	25135	51-38
	50-20		26-10	25164	23-15
	51-40		26-36		53-34
	52-04		27-09	25171	03-09
	52-22		27-26		03-25
	53-03		28-06		04-09
	54-39		29-07		04-26
	55-26		30-08		07-11
	57-12		31-08	25256	26-18
	58-12		37-08	25302	39-15
	59-12		38-09		41-20
	60-12		50-05		43-19
	61-12		50-09	25312	39-17
	62-12		50-12		41-22
	63-13		50-22	25314	39-11
	64-12		50-45		41-16
2441	03-19		51-42	25316	39-09
	04-20		51-45		41-14
	05-06		54-42	25317	39-08
	06-06		55-23		41-13
	07-04		57-20	25318	39-07
	07-14		58-10		41-12
	21-21		59-10	25320	39-26
	26-02		60-10		41-29
	27-02		61-10		42-41
	37-09		62-10	25321	39-27
	38-10		63-11		41-30
2443	07-10		64-10		42-42
2457	65-28	2474	21-23	25328	03-14
24609	57-31	24764	03-02		04-14
	59-31		04-02		06-40
2471	05-48	24802	14-11	25387	39-20
	06-46		15-11	25388	39-19
	23-24		16-11	2555	30-07
	25-21		17-11		31-07
2472	23-29	24830	50-35	2560	32-14
	37-04		51-08	2794	05-32
	38-05	24835	50-35		06-30
	53-33		51-08	2848	22-31
2473	03-13		52-13		24-31
	03-22		53-21	2849	22-30
	04-13		54-05		24-30
	04-23		55-05	350998	08-02
	05-14		56-04		09-02
	05-19	2500	57-27	352024	39-06
	05-36		58-27		41-11
	06-14		59-27		
	06-28		60-25		

PART NUMBER	FIG. & INDEX	PART NUMBER	FIG. & INDEX	PART NUMBER	FIG. & INDEX
35966	14-09	401824	51-53	402127	26-16
	15-09	401830	07-17		27-11
	16-09	401841	01-10	402129	01-06
35967	14-10		02-10		02-06
	15-10	401852	37-15	402151	02-13
	16-10	401860	21-11	402153	01-12
	17-10	401861	01-15		02-12
35971	14-12		01-18	402162	02-15
	15-12		02-16	402711	65-10
	16-13		02-19	40652	14-16
	17-13		07-12		15-16
35972	18-03	401870	01-02	501867	26-27
35985	50-24		01-10		27-22
	51-43		02-02		57-19
	52-01		02-10		58-19
	52-26	401881	02-03		59-19
	53-01	401885	01-04		60-17
36151J	50-26		01-11		61-19
	51-14		01-14		62-19
	52-07		02-04		63-20
	53-14		02-11		64-19
36151L	50-26		02-14	501868	27-27
	53-14		14-07		32-17
	54-09		15-07		50-04
	55-09		21-12		50-52
	56-08		21-14		51-26
36151R	05-44	401886	01-09		54-29
	06-42		02-09		55-18
36181	06-12	401893	01-07		56-17
36219	39-18		02-07	502287	26-18
	41-23		08-16		27-13
401506	04-15		09-18	515152	14-06
	28-09		16-07		15-06
401507	07-15		17-07	520105	14-13
	07-21		65-10		15-13
	37-11	401895	02-11		16-14
	38-12	401945	01-15		17-14
401753	21-17		02-16	520106	14-14
401763	35-15	401963	01-02		15-14
401801	02-10		02-02	520112	14-04
401804	16-07		22-06		15-04
	21-13		23-20		16-04
401806	21-13		24-06		17-04
401808	01-10		25-16	520122-1	16-04
	02-10	401965	01-12		17-04
	09-18		02-12	522188	09-10
401809	01-13		26-12	525213	57-45
	02-18	401971	50-15		59-46
401814	01-13	402042	01-03	530028	35-16
	01-17		02-03	530181	63-11
	02-13	402056	01-08	530346	20-08
	02-18		02-08		50-43
401816	25-17	402066	02-16		50-53
401819	02-19		07-16		55-17

PART NUMBER	FIG. & INDEX	PART NUMBER	FIG. & INDEX	PART NUMBER	FIG. & INDEX
530367	14-23	532507	01-13	534740	05-07
	14-26		02-13		06-07
	15-23		02-18	534741	08-26
	15-26	532683	07-18		09-28
530383	08-13	532685	49-01	534742	37-14
	09-15	532686	49-02		38-15
530386	08-12	532687	49-03	534743	20-06
	09-14	532873	07-02		21-06
530455	39-10	532943	49-10	534750	39-05
	41-15	532944	49-11		40-05
530658	18-02	532945	49-12		41-05
531001	03-10		49-17		42-05
	03-26	532946	49-15		43-05
	04-10	532947	49-16	534757	08-25
	04-27	533067	59-42		09-27
	14-02	533067-1	57-43	534775	26-50
	15-02		59-43		27-40
	16-02	534316	26-05	534787	28-03
	17-02	534337	57-15	534816	26-42
531083	05-11		58-15	534857	16-33
	06-11		59-15		17-33
531141	07-03		61-15	534861	38-13
531178	37-21		62-15	534861A1	37-12
	38-22		63-16	534862	22-49
531378	23-19		64-15		24-49
	25-15	534360	50-41	534863	37-17
531494	07-25		51-11		38-18
531547	25-26		53-28	534873	23-09
531548	01-05	534365	50-40	534895	12-01
	02-05		51-10		12-01
531649	01-09		53-27	53489519	12-
532148	45-10	534445	06-17	534895A7	12-
532149	45-11	53445	05-22	534900	26-30
532151	45-12	534470	05-01	534916	26-23
532200	14-41		06-01	534934	26-29
	15-41	534487	17-26	534938	26-38
	16-41	534503	33-01		27-29
	17-41	534609	14-35	534940	20-01
532313-27	57-41		15-35		21-01
	59-40		16-34	534941	05-17
532362	49-14		17-34		19-10
	49-19	534610	14-36		57-04
532364.50	52-20		15-36		58-04
	53-39		16-35		59-04
532432	01-22		17-35		60-04
	02-23	534625	21-24		61-04
	20-12	534655	10-09		62-04
	22-33		11-08		63-05
	24-33	534685	26-39		64-04
532450-1	14-28		27-30	534942	05-18
	15-28	534715	26-40	534947	03-01
532451	14-32		27-31	534948	03-01
	15-32	534728	05-08		
			06-08		

PART NUMBER	FIG. & INDEX	PART NUMBER	FIG. & INDEX	PART NUMBER	FIG. & INDEX								
534956	19-08	535662	10-06	536033	17-21								
	57-06		11-05		17-24								
	58-06		535666		10-07	536036	50-01						
	59-06				11-06	536037	50-02						
	60-06				14-19	536038	16-39						
	61-06				15-19	536213	28-02						
	62-06				54-37		29-02						
	63-07				55-24		30-02						
	64-06				535668	36-02		31-02					
	534969					26-13	535681	50-29	536326	51-19			
						534976A1		26-24		55-12	54-16		
						534980		26-43		535709	03-11	536332	51-18
								27-34			04-11	536332A1	51-17
						534982		26-20			05-34	536379	08-23
534987		19-07						06-32		09-25			
		534995		19-11		535737		10-04		536410	14-37		
57-01			535756	35-14				15-37					
58-01			535784	50-51				536413			50-38		
59-01				51-24							51-01		
60-01				54-23							52-16		
61-01			535785	50-50							53-25		
62-01				51-25							54-01		
63-01				54-22	55-01								
64-01	535787		50-47	56-01									
535008			22-38	51-21	536421		08-22						
	23-05		54-18	09-24									
	24-38		535810	03-15	536432		50-16						
535010	23-				04-16		536449		26-19				
	535042		39-23	535823	05-31		536485		49-04				
535076		50-34	06-26		536486	49-							
	535079	50-33	535832	50-28	536552	26-22							
535118		14-29		535847	39-04		27-17						
	15-29	40-04	536563		08-21								
	16-30	41-04			09-23								
	17-30	42-04			26-28								
	535425	26-31				43-04	536740	50-39					
		535468			39-13	535856		26-01	51-09				
	535469				39-14		535885	23-22	53-26				
		535484			50-32			25-19	536795	51-47			
	535541				28-02	535887	23-23	536871	51-28				
		535557			39-20		25-20	536872	51-29				
					41-35	535900	22-39	536911	51-39				
	535559	39-					24-39	536938	12-03				
		535631			34-02	535908	23-21		13-03				
	35-02				25-18		536939	12-04					
36-02	50-46			13-04									
53-24	28-04		537019	16-27									
535634	22-37	535933	22-46		17-27								
	23-06		24-46	537229	22-22								
	24-37		01-21		24-22								
	535651		26-34			02-22	537235	22-25					
535660		10-03	535958		35-09	537282	36-05						
	11-03	535960		51-27									
535661	10-02	535961	50-23										
	11-02												

PART NUMBER	FIG. & INDEX	PART NUMBER	FIG. & INDEX	PART NUMBER	FIG. & INDEX
537296	14-38		51-49		51-05
	15-38		54-40		53-18
	16-37		55-21	538580	22-22
	17-37	537873	51-02		24-22
537297	01-31		52-12	538607	31-15
	02-32	537874	51-04	538609	22-
537299	05-39		52-10		24-
	06-37	537875	51-03	538650	03-29
537312	36-07		52-11		04-30
537341	26-25	537883	12-01	538727	22-42
537422	01-08	537883A6	12-		24-42
	02-08	537911	41-40	538735	22-23
	10-05		43-27	538736	22-25
	11-04		57-44		24-25
537505	01-30		59-45	538773	05-28
	02-31		63-16		06-23
537539	28-11		63-32	538789	22-41
	29-10		64-31		23-14
	30-11	537939	51-44		24-41
	31-11	537961	51-27		25-10
	32-10		52-25	538801	05-28
537589	22-23		54-28		06-23
537629	38-03		55-17	538804	05-27
	57-20		56-16		06-22
	59-20	538069	28-13	538814A7	21-
	63-21	538070	28-13	538814A1	21-
	64-20	538076	10-01	538872	50-19
537650	20-07		11-01	538882	52-17
537682	19-06	538100	56-23	538927	52-03
537690	57-26	538127	07-22	538937	21-02
	58-26	538135	07-07	538944-10.50	03-05
	59-26	538136	07-08		04-05
	60-24	538185	22-04	538944-8.88	03-06
	61-26		24-04		04-06
	62-26	538304	16-38	538949	03-30
	63-27		17-38		04-31
	64-26	538305	14-40		53-11
537721	01-16		15-40	538969	05-33
	02-17	538346	28-12		06-31
537728	55-28	538361A1	50-06	538989	03-27
537738A1	26-	538433	51-20		04-28
	27-		54-17	538996	51-48
537742	26-06	538434A1	51-50	538999	26-07
	27-05	538468	51-33		27-06
537743	26-11		54-35		50-10
537743A2	26-		56-35	539023	53-12
537745	26-51	538469	51-30	539050-10.75	03-08
	27-41		54-30	539050-9.81	03-07
537749	26-42	538480	39-28		04-07
	27-33	538516	22-	539058	05-05
537750	21-07		24-		06-04
	26-34	538554	50-32		26-03
	27-24		50-33		27-03
	32-18		50-34		

PART NUMBER	FIG. & INDEX	PART NUMBER	FIG. & INDEX	PART NUMBER	FIG. & INDEX
625601	65-02	626530	53-30		61-08
625615	16-29	626540	14-17		62-08
	17-29		15-17		63-09
625616	16-29		16-18		64-08
625735-A1	65-		17-18	626845	19-01
625765	40-01	626553	66-07	626856	05-30
	43-01	626557	66-05	626879-1	57-14
625782	16-17	626577-2	57-39		58-14
625821	16-17		58-39		59-14
625859	16-		59-39		60-14
	17-		60-36		61-14
625859A1	16-		61-38		62-14
	17-		62-41		62-30
625859A3	16-		63-43		63-15
625859A7	16-		64-41		63-31
625859CP	16-	626577-2R	41-32		64-14
	17-		43-30		64-30
625886	22-40	626586	65-25	626889	08-15
	23-01	626634	57-22		09-17
	24-40		58-22		08-19
	25-01		59-22		09-21
625965	39-23		60-20	626891	57-30
625965-1	39-24		61-22		59-30
625966	01-34		62-22		62-29
	02-34		63-23		63-34
625982	39-13		64-22		64-33
625983	39-14		65-13	626910	65-22
626026	39-12		65-26	626919	40-30
626089	21-20	626640	03-01	626960	26-01
626140	18-04	626713	46-10	626963	05-23
626147	14-39		47-18		06-18
	15-39	626714	46-09	626990	03-03
	16-36		47-17		04-03
	17-36	626718	45-08	626992	13-01
626189	36-01		46-17	626992A1	13-
626226-A1	65-		47-08	627001	41-24
626234-A1	65-		48-08	627002	39-22
626332	36-13	626735-A2	65-		41-25
626334	01-33	626739	08-14	627011	54-12
	02-33		09-16		55-12
626341	36-15	626744	54-12	627038	39-14
626342	36-12	626791	65-	627039	39-13
626486	41-33	626791-A1	65-	627068	29-18
	43-29		57-17	627076	57-28
	57-33	626813	65-04	627076A1	57-
	58-33		65-15		59-
	59-33		65-19	627094	57-29
	60-31	626820	17-		59-29
	61-33	626820A8	17-	627164	06-36
	64-35	626820CP	17-	627166	06-23
626524	41-41	626836A1	57-	627178	51-39
	57-42	626839	57-08	627250A1	54-14
	59-44		59-08	627254	54-21
626527	53-29		60-08	627272	28-04
					29-04

PART NUMBER	FIG. & INDEX	PART NUMBER	FIG. & INDEX	PART NUMBER	FIG. & INDEX
627273	28-04		59-	628008	06-03
	29-04		60-	628023	52-21
627274	28-04		61-	628051	14-
	29-04		62-	628051A1	14-
627276	29-13		63-	628051CP	14-
627277	29-19		64-	628095	65-22
627279	29-15	627544	63-29	628129	22-48
	30-17		64-28		24-48
	31-18	627544A1	63-	628136	08-10
627281	29-16		64-		09-11
	30-18	627545	63-30	628152	57-38
	31-19		64-29		58-38
	32-16	627643	39-12		59-38
627282	29-17	627650	22-21		60-35
	30-19		24-21		61-37
627315A3	64-	627651	22-18		62-40
627315A7	64-		24-18		63-42
627326	65-	627652	22-19		64-40
627326-A1	65-		24-19	628153	57-38
627326-A2	65-	627658A1	50-07		58-38
627326A1	64-17	627670	54-43		59-38
627326A2	64-17	627673	29-11		60-35
627326A3	60-15		31-12		61-37
627335	57-37	627673-2	30-12		62-40
	59-37		32-19		63-42
	60-34	627681	54-36		64-40
	61-36		55-20	628154	57-38
	62-39	627690	29-19		58-38
627335-12	63-41	627713	64-28		59-38
627335D12	58-37	627713A1	64-		60-35
	64-39	627734	64-29		61-37
627368	54-47	627738	13-01		62-40
	55-36	627738A6	13-		63-42
	56-56	627756	41-28		64-40
627377	29-03		43-23	628198	09-16
	30-03	627759	41-27	628207	04-01
627378	66-06		43-22	628245	07-
627390	54-30	627759	43-23	628257	05-02
627392	34-01		41-27	628257	06-02
	35-01	627804	41-19	628264	64-45
627400	06-25	627805	41-18	628271	41-31
627433	04-12	627809	65-22		41-38
	06-32	627820	55-13		43-24
627449	41-17	627836	54-43		43-26
627450	41-17		55-32	628295	62-35
627458	24-23	627841	26-01		63-37
627480	13-06	627862	41-19	628301	62-36
627494	22-16	627863	41-18		63-36
	24-16	627921	41-26	628319	27-40
627495	22-17		43-21	628320-11.00	43-13
	24-17	627978	39-12	628320-12.75	43-11
627518	19-07	628004	30-21	628320-14.25	43-14
	57-		31-22	628320-16.00	43-12
	58-	628005	31-03	628320-16.25	43-10

PART NUMBER	FIG. & INDEX	PART NUMBER	FIG. & INDEX	PART NUMBER	FIG. & INDEX
628320-17.50	43-15	628750	08-13	629176	27-01
628336	53-02		09-15	629324-A1	65-
628372A1	21-	628752	18-	629325	53-19
628379	43-	628754	13-03		54-03
628380	43-	628760	26-49		55-03
628381	53-17		27-39		56-03
628382-A1	65-	628766	56-13	629329	65-05
628383	53-06	628775	65-	629330	62-23
628390	53-09	628775-A1	65-	629338	62-28
628391-31.75	43-07	628775A1	59-17	629338A1	62-
628391-32.00	43-08	628776A1	59-	629353	55-29
628391-32.50	43-16	628816	56-26	629354	55-30
	43-17	628822	56-18	629364	62-21
628391-36.50	43-18	628833	56-25	629364A1	62-
628391-37.50	43-09	628859	25-10	629397	65-
628409	21-02	628861	65-	629397-A1	65-
628416	63-36	628861-A1	65-	629397A1	62-17
628428A1	59-	628861A1	61-17	629399A1	62-
628429	65-	628891A3	61-	629417	30-04
628429-A1	65-	628914	65-22		31-04
628429A1	59-17	628981	65-11	629418	65-22
628439	57-38	628985	13-02	629494	42-34
	59-38	628986	45-07	629495	42-33
628440	59-38		46-16	629496	42-32
628441	57-38		47-07	629498	42-31
	59-38		48-07	629502	48-10
628472	41-01	629007	41-07	629504	48-13
	42-01		42-10	629505	48-14
628473	41-01	629008	41-08	629506	48-16
	42-		42-07	629511	04-01
628474	43-25		42-12	629518-1	01-24
628482	26-01	629009	41-09		01-25
	27-01		42-08		02-25
628488	10-10		42-13		02-26
	11-09	629010	41-10		14-08
628489	10-10		42-09		15-08
	11-09		42-14		16-08
628491	10-11	629011	41-07		17-08
	11-10		42-15	629518-1H	50-14
628528-A1	65-	629076	37-18		51-52
628543	06-36		38-19		53-07
628580	31-14	629077	37-20	629518-3	01-27
628581	38-13		38-21		01-28
628583	31-21	629104	08-08		02-28
628597	53-35		09-07		02-29
628698	20-07	629117	16-12	629595	54-13
628701	54-24		17-12		55-13
628703	56-12	629138	50-31	629597	54-13
628705	56-11		53-20	629599	53-02
628730	32-09		54-02	629601	53-06
628739	41-06		54-04	629613-A2	65-
628739	42-06		55-02	629675	07-09
628740	41-		55-04	629703-2A1	62-18
628740	42-11		56-02	629713	27-12
628744A1	60-	629163	53-13	629825	30-14

PART NUMBER	FIG. & INDEX	PART NUMBER	FIG. & INDEX	PART NUMBER	FIG. & INDEX
629837	40-28	630988	32-11	631764	60-13
	42-37	630989	32-05	631818	65-22
629847	01-32	631000	32-04	631819	65-01
629848	09-13	631094	32-02	631845	11-04
629871	65-05	631111	32-01	631915	06-41
629882	09-	631200	32-06	631927	01-31
629885	07-01	631202	32-07	631928	05-42
629887	02-	631237	39-01		06-40
629904-2A1	63-19		41-01	631932	63-14
629939	03-01	631252	26-20	631972	50-25
630039	30-20		27-15		51-15
630069	65-	631261	26-01		54-08
630069-A1	65-		27-01		55-08
630069A1	63-18	631266-1	05-45		56-07
630074A1	63-		06-43	631995	22-29
630093	39-28	631275-1	06-44		24-29
	41-34	631277	40-06	632085	23-10
630124	65-01	631330	66-04		25-06
630184	66-06	631351A6	63-35	632105	40-27
630261-2	08-06		66-		42-38
	09-05	631427A1	57-32	632106	42-35
630261-3	09-05		59-32	632149	05-46
630261-32	09-05		60-30	632151	05-43
630261-35	08-06		63-35	632195	09-
630261-37	08-06		64-34	632280	54-26
630261-4	09-05		66-	632312	32-08
630261-5	08-06	631427A11	59-32	632319	09-12
630296	55-15		66-	632323	50-29
630378	39-12	631427A2	61-32	632357	05-04
630387	58-20		66-	632443-4	08-17
	60-18	631427A3	58-32		09-19
	61-20		62-34	632478	22-09
	62-20		66-	632516	41-17
	63-21	631478	22-27	632554-2	65-06
630455	65-09		24-27	632556	65-05
630464	08-12	631481	13-01	632557	63-24
	09-14	631481A1	13-	632558	63-22
630474	55-27	631496	16-06	632558A1	63-
630519	31-20		17-06	632563	22-
	32-15	631544	16-40		24-
	16-09		17-40	632563A10	22-
630591	16-09	631618	22-08	632563A2	22-
	17-09		24-08	632563A4	22-
630626	50-42	631638	22-26	632563A5	22-
630627	54-27		24-26		24-
	55-14	631650	23-08	632563A6	24-
630628	55-14		25-05	632563A7	22-
630686	29-04	631653	22-10		24-
630693-10.44	03-15		24-10	632563A8	24-
630886	09-	631683	63-04	632563A9	24-
630927	09-	631684	63-01	632761	22-11
630932	09-	631685	63-05		24-11
630977	09-	631739	42-36	632762	22-15
630985	32-03	631755	06-25		24-15

PART NUMBER	FIG. & INDEX	PART NUMBER	FIG. & INDEX	PART NUMBER	FIG. & INDEX
632837	15-34	633582	40-24	635050	26-15
632855-2A1	63-	633583	40-23		27-10
632859	58-28		40-40	635050A4	26-
	60-26	633584	40-22		27-
	61-28	633585	40-21	635095	13-02
632859A1	58-27		40-45	635158-15.00	63-38
	61-	633586	40-20		64-36
632916-2A2	63-19		40-44	635158-16.00	63-38
632932	13-01	633589	40-39	635158-17.00	63-39
632932A3	13-	633590	40-41		64-37
633009	42-30	633591	40-43	635158-18.00	63-39
633012	48-11	633592	40-42	635158-40.00	63-40
633062	32-12	633593	40-38		64-38
633068	23-28	633845	26-28	635360	42-40
	25-25		27-23	635363	42-39
	37-01	633925	40-37	635557	12-02
	38-01	633926	40-36		13-02
633096	48-12	633927	40-32	635623	08-07
633099	48-15	634011	66-01		09-06
633113	39-13	634150	22-09	635993	36-01
633114	39-14		24-09	635995	36-01
633136	08-11	634504-10.75	04-08	636675	45-02
633143	65-	634505	14-01		46-02
633143-A1	65-		15-01		46-12
633143A1	63-18		16-01		47-02
633189	08-09		17-01		47-10
	09-09	634511	03-28		48-02
633195	63-29	634592	26-01	636676	45-03
633198	63-30	634673	32-04		46-03
633219	08-	634675	41-17		47-03
633225	08-		42-16		47-11
633227	08-	634805	54-33		48-03
633246	09-	634807	51-34	636677	45-04
633254	09-08		54-34		46-04
633256	08-		56-31		47-04
633258	08-	634919	04-01		47-12
	09-	634920	04-01		48-04
633311	40-07	634921	04-01	636678	45-05
633317	13-05	634922	04-01		46-05
633412	20-07	634924	04-01		46-14
633435	56-15	634925	04-01		47-05
633579	40-10	634926	04-01		47-13
	40-11	634927	04-01		48-05
	40-12	634928	04-01	636679	48-06
	40-13	634929	04-01	636687	40-31
	40-14	634932	04-01	636692	40-26
	40-15	634934	04-01	636922	40-29
	40-16	634935	04-01	636954	42-17
633580	40-08	634956	03-01	637409-48	42-18
	40-09	634958	03-01		42-19
	40-17	634959	03-01		42-20
	40-18	634960	03-01		42-21
	40-19	634961	03-01		42-22
633581	40-25	634964	03-01		42-23
			04-01		42-24

PART NUMBER	FIG. & INDEX	PART NUMBER	FIG. & INDEX	PART NUMBER	FIG. & INDEX
	42-25	639418-2	01-19		
	42-26		02-20		
	42-27	639437	65-		
	42-28	639479	65-14		
	42-29	639565	13-02		
637781	17-18	639566	13-03		
637836	16-15	639573	16-26		
	17-15	639629	16-21		
637847	27-01		16-24		
638154-3A2	63-	639642	06-18		
638156-3A1	57-09	639660-11	50-28		
	59-09		50-30		
638156-3A11	58-09		54-11		
638156-3A18	60-09	639663	13-05		
638156-3A2	64-09	639761	65-		
638156-3A6	61-09	639761-A1	65-		
638156-3A7	63-10	639766A1	58-17		
638156-3A8	62-09	63997	05-12		
638156-9A1	59-09	640087	23-13		
638161	09-22	640107A1	58-		
638172	37-22	640120A1	58-		
	38-23	640518	13-01		
638440	57-38	640518A1	13-		
639152	36-01	640620-12	05-30		
639185A1	63-	640620-8	05-30		
639193	08-04	640919	22-13		
	09-04		24-13		
639195	08-	640944	16-		
	09-		17-		
639196	09-	641139	50-19		
639197	08-	641185	01-		
639234A1	59-	641186	01-		
639246A1	57-	641189	02-		
639247A1	59-	641191	02-		
639248A1	57-	641192	02-		
639255A1	60-	641197	02-		
639257A1	64-	641206	02-		
639258A1	64-	641213	01-		
639260A1	61-		02-		
639261A1	63-	641214	02-		
639264A1	62-	641226	01-		
639266	62-13	641250	08-20		
	64-13	641270	01-		
639268	57-13	641273	02-		
	58-13	641368	26-17		
	59-13	641373	01-		
	61-13	641390	03-01		
	63-14				
	64-13				
639292	18-05				
639304	05-22				
	06-17				
639305	36-14				
639418-1	01-20				
	02-21				

SECTION VI

CUSTOMERS SPECIFICATIONS

The following pages contain, in tabulated form, the various customer specifications of the basic O-470/IO-470 aircraft engines.

If the customer specification number does not appear on the engine nameplate, check the serial number and locate the customer spec in the serial number to customer spec cross reference list in Section I. All engines manufactured after January 1973 have the customer spec number stamped on the nameplate.

In some instances, certain accessories are furnished by the aircraft manufacturer. If an accessory on the engine does not appear on the customer spec, determine whether it is available from the aircraft manufacturer.

CONTINENTAL MODEL IO-470-D

(SPECIFICATIONS NOT SHOWN SAME AS BASIC ENGINE)

SPEC. NUMBER	STARTER SEE TABLE 1	GENERATOR SEE TABLE 1	MAGNETO	IGNITION HARNASS	OIL COOLER	CRANKCASE STUDING ASSEMBLY	ENGINE MOUNTING LEG	SHAFT STARTER DRIVEN	SHAFT GEN./ALT. DRIVEN	GEN. MOUNTING BRACKET	BRACKET, GEN. SUPPORT	BRACKET, ADJ. ARM	FUEL INJECTION SYSTEM (A)
1	628482	627274	631237	627804 627805	639152 (C)			534775	627377				639257A1
4	628482	627274	631237	627804 627805	639152 (C)			534775	627377				639257A1
5	539910	627273	631237	628073 628074	639152 (C)	628008 (B)	627690	534775	627377	627068	627276		639257A1
7	628482	627274	631237	627804 627805	639152 (C)			534775	627377				639257A1
9	628482	627274	631237	627804 627805	639152 (C)			534775	627377				639257A1
12	628482	627274	631237	627804 627805	639152 (C)	628008 (B)	627690	534775	627377	627068	627276		639257A1
15	628482	627274	628472 628473	636954	639152 (C)			534775	627377				639257A1
19	628482	629417	628472 628473	627804 627805	639152 (C)	628008 (B)	628004	628319	628005	628583	628580		639262A1
25	628482	629417	628472 628473	636954	635995	628008 (B)	628004	628319	628005	628583	628580		639257A1
27	628482	629417	628472 628473	636954	639152 (C)	628008 (B)	628004	628319	628005	628583	628580		639263A1
30	637847	629417	631237	627804 627805	639152 (C)	628008 (B)	628004	628319	628005	628583	628580		639257A1
42	539910	627274	631237	627804 627805	639152 (C)			534775	627377				639257A1
44	637847	627274	628472 628473	636954	639152 (C)	628008 (B)		534775	627377	627068	627276		639257A1
50	628482	629417	628472 628473	636954	639152 (C)	628008 (B)	628004	628319	628005	628583	628580		639257A1
52	628482	627274	628472 628473	636954	639152 (C)	628008 (B)	627690	534775	627377	627068	627276		639257A1

(C) Non-congealing

(A) See Service Bulletin M74-13
 (B) Use at left rear when generator is furnished

CONTINENTAL MODEL IO-470-F

(SPECIFICATIONS NOT SHOWN SAME AS BASIC ENGINE)

SPEC. NUMBER	STARTER SEE TABLE 1	GENERATOR SEE TABLE 1	MAGNETO	IGNITION HARNASS	OIL COOLER	CRANKCASE STUDING ASSEMBLY	ENGINE MOUNTING LEG	SHEAVE STARTER DRIVEN	SHEAVE GEN./ALT. DRIVEN	GEN. MOUNTING BRACKET	BRACKET, GEN. SUPPORT	BRACKET, ADJ. ARM	FUEL INJECTION SYSTEM (A)
1	637847	627272	631237	627804 627805	534503		539518(3) 628257(1)	534775	627377	627690	627068	627276	640107A1
3	637847	627272	628472 628473	636954	534503		539518(3) 628257(1)	534775	627377				640106A3
4	637847	629417	628472 628473	636954	626189		539518(3) 628257(1)	628319	628005	628004	628583	628580	640106A4
7	634592		625765	633311	626189	629398	539518(3) 628257(1)		628005	628004			640106A3
8	637847		628472 628473	636954	534503	629398	539518(3) 628257(1)						640107A1
9	637847		625765	633311	626189		539518(3) 628257(1)						640107A1
11	637847		625765	633311	534503		539518(3) 628257(1)						640107A1
17	637847		625765	633311	626189	629398	539518(3) 628257(1)						640107A1
18	637847	627272	625765	633311	639151	629398	539518(3) 628257(1)	628319	628005	628004			640107A1

(A) See Service Bulletin M74-13

CONTINENTAL MODEL IO-470-L

(SPECIFICATIONS NOT SHOWN SAME AS BASIC ENGINE)

SPEC. NUMBER	STARTER SEE TABLE 1	GENERATOR SEE TABLE 1	MAGNETO	IGNITION HARNASS	OIL COOLER	CRANKCASE STUDING ASSEMBLY	ENGINE MOUNTING LEG	SHEAVE STARTER DRIVEN	SHEAVE GEN./ALT. DRIVEN	GEN. MOUNTING BRACKET	BRACKET, GEN. SUPPORT	BRACKET, ADJ. ARM	FUEL INJECTION SYSTEM (A)
1	637847	629416	628472 628473	636954	626189	629300	628257 (B)	534257	627377	628004	630039	629825	639255A1
3	637847	629416	628472 628473	636954	626189	629300	628257 B	534775	627377	628004	630039	629825	639254A1
5	637847	629416	628472 628473	636954	639151		628257 (B)	534775	627377	628004	630039	629825	639254A1
8	637847	631111	628472 628473	636954	639151	629300		534775	630985	631000	631200	632312	639253A1
9	637847	631111	632958 632959	636952	639151	629300	628257 (B)	534775	630985	631000	631200	632312	639253A1
13	637847		628472 628473	636954			628257 (B)			628004	631200	629825	639253A1
15	637847	634692	628472 628473	636954	639151			635169	634571	634673 (C)		634617	639253A1
18	637847	631111	632958 632959	636952	639151		628257 (B)	534775	630985	631000	631200	632312	639253A1
19	637847	634692	636141	636140	639151			635169	634571	634673 (C)		634617	639253A1
20	637847		628472 628473	636954	626189								639253A1
21	637847	634692	640030	640031	639151			635169	634571	634673 (C)		629825	639253A1

(A) See Service Bulletin M74-13

(B) Use (1) 628257 or (1) 634673 and 539518 when engine is equipped with generator or alternator

(C) Combination alternator mounting, bracket and engine mount leg

CONTINENTAL MODEL O-470-E

(SPECIFICATIONS NOT SHOWN SAME AS BASIC ENGINE)

3	628482	627273	631237	625298 625299	534503	539164															
SPEC. NUMBER	STARTER SEE TABLE 1	GENERATOR SEE TABLE 1	MAGNETO	IGNITION HARNES	OIL COOLER	CARBURETOR	CRANKCASE STUDING ASSEMBLY	ENGINE MOUNTING LEG	FUEL PUMP	ADAPTER	PRIMING SYSTEM	OIL PUMP	FUEL INJECTION SYSTEM (A)								

CONTINENTAL MODEL O-470-K

(SPECIFICATIONS NOT SHOWN SAME AS BASIC ENGINE)

SPEC. NUMBER	STARTER -SEE TABLE 1	GENERATOR SEE TABLE 1	MAGNETO	IGNITION HARNES	OIL COOLER	CARBURETOR	CRANKCASE STUDING ASSEMBLY	ENGINE MOUNTING LEG	FUEL PUMP	ADAPTER	PRIMING SYSTEM	OIL PUMP	FUEL INJECTION SYSTEM (A)
1	628482	627273	631237	525298 525299	534503								
3	628482	627273	631237	525298 525299	534503								
5	628482	627273	631237	525298 525299	534503	626859		534470	535262 ①	627518 ①	536486 ②		
9	628482	627273	631237	525298 525299	534503								
14	628482	627273	631237	525298 525299	627392		626589						
15	628482	627273	631237	525298 525299	534503		626589						
17	628482	627272	631237	525298 525299	616189								

① See Figure 19 For Related Parts
 ② See Figure 46 For Breakdown

T A B L E I

STARTERS

535856	DELCO REMY	12V
539910	DELCO REMY	12V
626960	DELCO REMY	12V
627841	DELCO REMY	24V
628482	DELCO REMY	12V
629176	DELCO REMY	12V
631261	DELCO REMY	12V
634592	DELCO REMY	12V
637487	DELCO REMY	24V

GENERATORS

535928	DELCO REMY	24V	
627272	DELCO REMY	12V	50 AMP
627273	DELCO REMY	12V	35 AMP
627274	DELCO REMY	24V	25 AMP
629416	DELCO REMY	24V	40 AMP
629417	DELCO REMY	24V	50 AMP
630687	DELCO REMY	24V	25 AMP

ALTERNATORS

631111	DELCO REMY	24V	
634692	PRESTOLITE	24V	50 AMP
640393	PRESTOLITE	24V	50 AMP
641658	PRESTOLITE	24V	50 AMP