

REVISION

SKYLANE RG 1981 MODEL R182 PILOT'S OPERATING HANDBOOK

**REVISION 1
24 MAY 1982**

D1198R1-13PH

**INSERT THE FOLLOWING REVISED PAGES
INTO BASIC PILOT'S OPERATING HANDBOOK**

CONGRATULATIONS

Welcome to the ranks of Cessna owners! Your Cessna has been designed and constructed to give you the most in performance, economy, and comfort. It is our desire that you will find flying it, either for business or pleasure, a pleasant and profitable experience.

This Pilot's Operating Handbook has been prepared as a guide to help you get the most pleasure and utility from your airplane. It contains information about your Cessna's equipment, operating procedures, and performance; and suggestions for its servicing and care. We urge you to read it from cover to cover, and to refer to it frequently.

Our interest in your flying pleasure has not ceased with your purchase of a Cessna. World-wide, the Cessna Dealer Organization backed by the Cessna Customer Services Department stands ready to serve you. The following services are offered by most Cessna Dealers:

- THE CESSNA WARRANTY, which provides coverage for parts and labor, is available at Cessna Dealers worldwide. Specific benefits and provisions of warranty, plus other important benefits for you, are contained in your Customer Care Program book, supplied with your airplane. Warranty service is available to you at authorized Cessna Dealers throughout the world upon presentation of your Customer Care Card which establishes your eligibility under the warranty.
- FACTORY TRAINED PERSONNEL to provide you with courteous expert service.
- FACTORY APPROVED SERVICE EQUIPMENT to provide you efficient and accurate workmanship.
- A STOCK OF GENUINE CESSNA SERVICE PARTS on hand when you need them.
- THE LATEST AUTHORITATIVE INFORMATION FOR SERVICING CESSNA AIRPLANES, since Cessna Dealers have all of the Service Manuals and Parts Catalogs, kept current by Service Letters and Service News Letters, published by Cessna Aircraft Company.

We urge all Cessna owners to use the Cessna Dealer Organization to the fullest.

A current Cessna Dealer Directory accompanies your new airplane. The Directory is revised frequently, and a current copy can be obtained from your Cessna Dealer. Make your Directory one of your cross-country flight planning aids; a warm welcome awaits you at every Cessna Dealer.

PERFORMANCE - SPECIFICATIONS

SPEED:

Maximum at Sea Level	160 KNOTS
Cruise, 75% Power at 7500 Ft	156 KNOTS

CRUISE: Recommended lean mixture with fuel allowance for engine start, taxi, takeoff, climb and 45 minutes reserve.

75% Power at 7500 Ft	Range	845 NM
88 Gallons Usable Fuel	Time	5.5 HRS
Maximum Range at 10,000 Ft	Range	1135 NM
88 Gallons Usable Fuel	Time	9.0 HRS

RATE OF CLIMB AT SEA LEVEL 1140 FPM

***SERVICE CEILING 14,300 FT**

TAKEOFF PERFORMANCE:

Ground Roll	820 FT
Total Distance Over 50-Ft Obstacle	1570 FT

LANDING PERFORMANCE:

Ground Roll	600 FT
Total Distance Over 50-Ft Obstacle	1320 FT

STALL SPEED (KCAS):

Flaps Up, Power Off	54 KNOTS
Flaps Down, Power Off	50 KNOTS

MAXIMUM WEIGHT:

Ramp	3112 LBS
Takeoff or Landing	3100 LBS

STANDARD EMPTY WEIGHT:

Skylane RG	1752 LBS
Skylane RG II	1805 LBS

MAXIMUM USEFUL LOAD:

Skylane RG	1360 LBS
Skylane RG II	1307 LBS

BAGGAGE ALLOWANCE 200 LBS

WING LOADING: Pounds/Sq Ft 17.8

POWER LOADING: Pounds/HP 13.2

FUEL CAPACITY: Total 92 GAL.

OIL CAPACITY 9 QTS

ENGINE: Avco Lycoming O-540-J3C5D
235 BHP at 2400 RPM

****PROPELLER: 2-Bladed Constant Speed, Diameter 82 IN.**

*The Service Ceiling is 18,000 ft if an EGT indicator is used to set the mixture.

**Performance with an optional 3-bladed propeller is essentially the same as shown above.

The above performance figures are based on the indicated weights, standard atmospheric conditions, level hard-surface dry runways and no wind. They are calculated values derived from flight tests conducted by the Cessna Aircraft Company under carefully documented conditions and will vary with individual airplanes and numerous factors affecting flight performance.

COVERAGE

The Pilot's Operating Handbook in the airplane at the time of delivery from Cessna Aircraft Company contains information applicable to the 1981 Model R182 airplane designated by the serial number and registration number shown on the Title Page of this handbook. This information is based on data available at the time of publication.

REVISIONS

Changes and/or additions to this handbook will be covered by revisions published by Cessna Aircraft Company. These revisions are distributed to all Cessna Dealers and to owners of U. S. Registered aircraft according to FAA records at the time of revision issuance.

Revisions should be examined immediately upon receipt and incorporated in this handbook.

NOTE

It is the responsibility of the owner to maintain this handbook in a current status when it is being used for operational purposes.

Owners should contact their Cessna Dealer whenever the revision status of their handbook is in question.

A revision bar will extend the full length of new or revised text and/or illustrations added on new or presently existing pages. This bar will be located adjacent to the applicable revised area on the outer margin of the page.

All revised pages will carry the revision number and date on the applicable page.

The following Log of Effective Pages provides the dates of issue for original and revised pages, and a listing of all pages in the handbook. Pages affected by the current revision are indicated by an asterisk (*) preceding the pages listed.

LOG OF EFFECTIVE PAGES

Dates of issue for original and revised pages are:

Original 15 August 1980

Page	Date	Page	Date
Title	15 August 1980	6-1	15 August 1980
Assignment Record ...	15 August 1980	6-2 Blank.....	15 August 1980
i thru iv	15 August 1980	6-3 thru 6-13	15 August 1980
1-1 thru 1-9	15 August 1980	6-14 Blank.....	15 August 1980
1-10 Blank.....	15 August 1980	6-15 thru 6-31	15 August 1980
2-1	15 August 1980	6-32 Blank.....	15 August 1980
2-2 Blank.....	15 August 1980	7-1 thru 7-42	15 August 1980
2-3 thru 2-11	15 August 1980	8-1	15 August 1980
2-12 Blank.....	15 August 1980	8-2 Blank.....	15 August 1980
3-1 thru 3-19	15 August 1980	8-3 thru 8-17	15 August 1980
3-20 Blank.....	15 August 1980	8-18 Blank.....	15 August 1980
4-1 thru 4-11	15 August 1980	9-1 thru 9-3	15 August 1980
4-12 Blank.....	15 August 1980	9-4 Blank.....	15 August 1980
4-13 thru 4-24	15 August 1980		
5-1	15 August 1980		
5-2 Blank.....	15 August 1980		
5-3 thru 5-28	15 August 1980		

NOTE

Refer to Section 9 Table of Contents for supplements applicable to optional systems.

TABLE OF CONTENTS

	SECTION
GENERAL	1
LIMITATIONS.....	2
EMERGENCY PROCEDURES.....	3
NORMAL PROCEDURES.....	4
PERFORMANCE.....	5
WEIGHT & BALANCE/ EQUIPMENT LIST	6
AIRPLANE & SYSTEMS DESCRIPTIONS	7
AIRPLANE HANDLING, SERVICE & MAINTENANCE	8
SUPPLEMENTS (Optional Systems Description & Operating Procedures)	9

COVERAGE

The Pilot's Operating Handbook in the airplane at the time of delivery from Cessna Aircraft Company contains information applicable to the 1981 Model R182 airplane designated by the serial number and registration number shown on the Title Page of this handbook. This information is based on data available at the time of publication.

REVISIONS

Changes and/or additions to this handbook will be covered by revisions published by Cessna Aircraft Company. These revisions are distributed to all Cessna Dealers and to owners of U. S. Registered aircraft according to FAA records at the time of revision issuance.

Revisions should be examined immediately upon receipt and incorporated in this handbook.

NOTE

It is the responsibility of the owner to maintain this handbook in a current status when it is being used for operational purposes.

Owners should contact their Cessna Dealer whenever the revision status of their handbook is in question.

A revision bar will extend the full length of new or revised text and/or illustrations added on new or presently existing pages. This bar will be located adjacent to the applicable revised area on the outer margin of the page.

All revised pages will carry the revision number and date on the applicable page.

The following Log of Effective Pages provides the dates of issue for original and revised pages, and a listing of all pages in the handbook. Pages affected by the current revision are indicated by an asterisk (*) preceding the pages listed.

LOG OF EFFECTIVE PAGES

Dates of issue for original and revised pages are:

Original	15 August 1980		
Revision 1	24 May 1982		
Page	Date	Page	Date
Title	15 August 1980	5-12 thru 5-28	15 August 1980
Assignment Record	15 August 1980	6-1	15 August 1980
i thru ii	15 August 1980	6-2 Blank	15 August 1980
*iii	24 May 1982	6-3 thru 6-13	15 August 1980
iv	15 August 1980	6-14 Blank	15 August 1980
1-1 thru 1-9	15 August 1980	6-15 thru 6-31	15 August 1980
1-10 Blank	15 August 1980	6-32 Blank	15 August 1980
2-1	15 August 1980	7-1 thru 7-42	15 August 1980
2-2 Blank	15 August 1980	8-1	15 August 1980
2-3 thru 2-11	15 August 1980	8-2 Blank	15 August 1980
2-12 Blank	15 August 1980	8-3 thru 8-17	15 August 1980
3-1 thru 3-19	15 August 1980	8-18 Blank	15 August 1980
3-20 Blank	15 August 1980	9-1 thru 9-3	15 August 1980
4-1 thru 4-11	15 August 1980	9-4 Blank	15 August 1980
4-12 Blank	15 August 1980		
4-13 thru 4-24	15 August 1980		
5-1	15 August 1980		
5-2 Blank	15 August 1980		
5-3 thru 5-10	15 August 1980		
*5-11	24 May 1982		

NOTE

Refer to Section 9 Table of Contents for supplements applicable to optional systems.

TABLE OF CONTENTS

	SECTION
GENERAL.....	1
LIMITATIONS.....	2
EMERGENCY PROCEDURES.....	3
NORMAL PROCEDURES.....	4
PERFORMANCE.....	5
WEIGHT & BALANCE/ EQUIPMENT LIST.....	6
AIRPLANE & SYSTEMS DESCRIPTIONS	7
AIRPLANE HANDLING, SERVICE & MAINTENANCE	8
SUPPLEMENTS (Optional Systems Description & Operating Procedures)	9

PILOT'S OPERATING HANDBOOK and FAA APPROVED AIRPLANE FLIGHT MANUAL

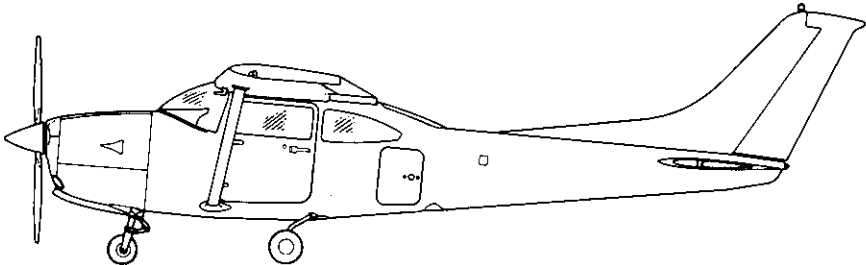

CESSNA AIRCRAFT COMPANY

1981 MODEL R182

THIS DOCUMENT MUST BE
CARRIED IN THE AIRPLANE
AT ALL TIMES.

Serial No. R18201741

Registration No. _____

THIS HANDBOOK INCLUDES THE MATERIAL REQUIRED TO BE
FURNISHED TO THE PILOT BY CAR PART 3 AND CONSTITUTES
THE FAA APPROVED AIRPLANE FLIGHT MANUAL.

COPYRIGHT © 1980

CESSNA AIRCRAFT COMPANY
WICHITA, KANSAS, USA

THIS MANUAL WAS PROVIDED FOR THE AIRPLANE IDENTIFIED ON THE TITLE PAGE ON _____. SUBSEQUENT REVISIONS SUPPLIED BY CESSNA AIRCRAFT COMPANY MUST BE PROPERLY INSERTED.

CESSNA AIRCRAFT COMPANY, PAWNEE DIVISION

This manual is issued to replace one originally provided for the airplane identified on the cover page on 4-15-81. All revisions, if any, have been incorporated as of 6-13-00.

Subsequent revisions supplied by Cessna Aircraft Company must be properly inserted.

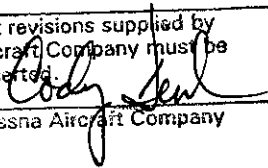
Cessna Aircraft Company

SECTION 1 GENERAL

TABLE OF CONTENTS

	Page
Three View	1-2
Introduction	1-3
Descriptive Data	1-3
Engine	1-3
Propeller (2-Bladed)	1-3
Propeller (3-Bladed)	1-3
Fuel	1-3
Oil	1-4
Maximum Certificated Weights	1-5
Standard Airplane Weights	1-5
Cabin And Entry Dimensions	1-5
Baggage Space And Entry Dimensions	1-5
Specific Loadings	1-5
Symbols, Abbreviations And Terminology	1-6
General Airspeed Terminology And Symbols	1-6
Meteorological Terminology	1-7
Engine Power Terminology	1-7
Airplane Performance And Flight Planning Terminology	1-7
Weight And Balance Terminology	1-8

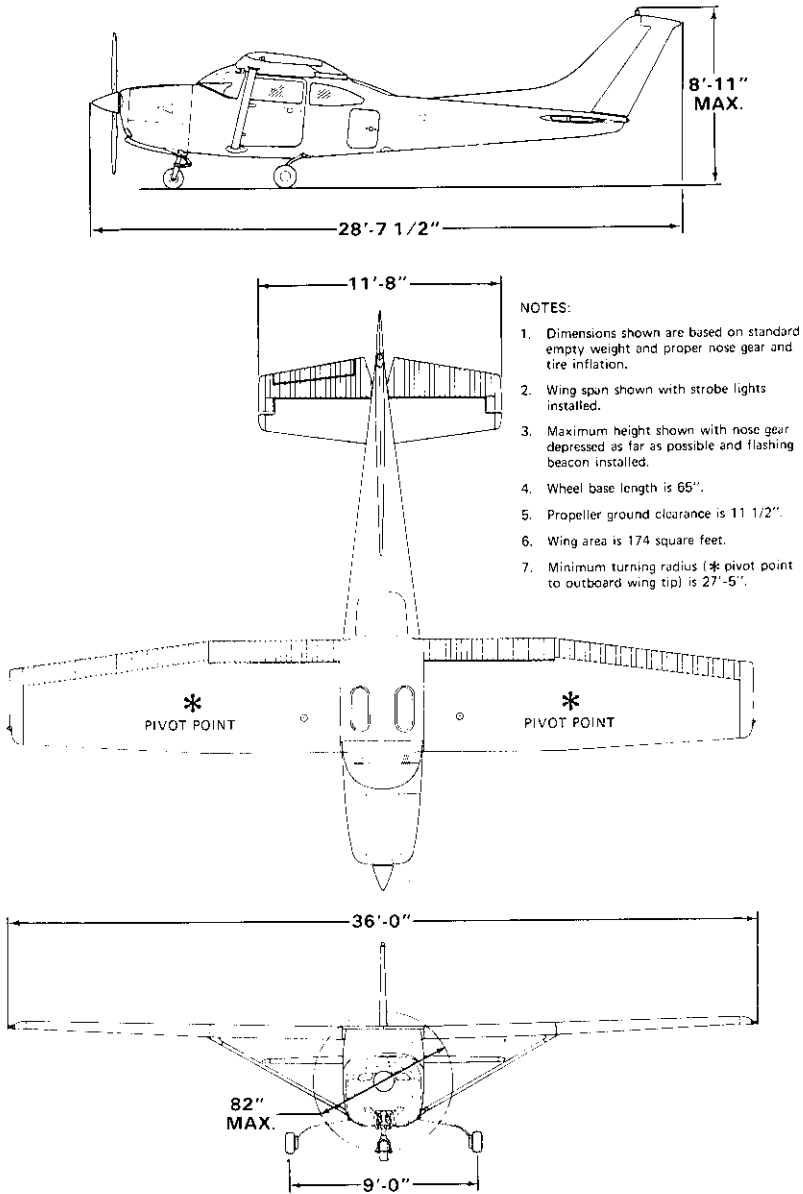

Figure 1-1. Three View

INTRODUCTION

This handbook contains 9 sections, and includes the material required to be furnished to the pilot by CAR Part 3. It also contains supplemental data supplied by Cessna Aircraft Company.

Section 1 provides basic data and information of general interest. It also contains definitions or explanations of symbols, abbreviations, and terminology commonly used.

DESCRIPTIVE DATA

ENGINE

Number of Engines: 1.
Engine Manufacturer: Avco Lycoming.
Engine Model Number: O-540-J3C5D.
Engine Type: Normally-aspirated, direct-drive, air-cooled, horizontally-opposed, carburetor equipped, six-cylinder engine with 541.5 cu. in. displacement.
Horsepower Rating and Engine Speed: 235 rated BHP at 2400 RPM.

PROPELLER (2-BLADED)

Propeller Manufacturer: McCauley Accessory Division.
Propeller Model Number: B2D34C218/90DHB-8.
Number of Blades: 2.
Propeller Diameter, Maximum: 82 inches.
Minimum: 80.5 inches.
Propeller Type: Constant speed and hydraulically actuated, with a low pitch setting of 15.8° and a high pitch setting of 29.4° (30 inch station).

PROPELLER (3-BLADED)

Propeller Manufacturer: McCauley Accessory Division.
Propeller Model Number: B3D32C407/82NDA-3.
Number of Blades: 3.
Propeller Diameter, Maximum: 79 inches.
Minimum: 78 inches.
Propeller Type: Constant speed and hydraulically actuated, with a low pitch setting of 16.0° and a high pitch setting of 31.7° (30 inch station).

FUEL

Approved Fuel Grades (and Colors):
100LL Grade Aviation Fuel (Blue).
100 (Formerly 100/130) Grade Aviation Fuel (Green).

NOTE

Isopropyl alcohol or ethylene glycol monomethyl ether may be added to the fuel supply. Additive concentrations shall not exceed 1% for isopropyl alcohol or .15% for ethylene glycol monomethyl ether. Refer to Section 8 for additional information.

Total Capacity: 92 gallons.
Total Capacity Each Tank: 46 gallons.
Total Usable: 88 gallons.

NOTE

To ensure maximum fuel capacity when refueling, and minimize cross-feeding when parked on a sloping surface, place the fuel selector valve in either LEFT or RIGHT position.

OIL

Oil Grade (Specification):

MIL-L-6082 Aviation Grade Straight Mineral Oil: Use to replenish supply during first 25 hours and at the first 25-hour oil change. Continue to use until a total of 50 hours has accumulated or oil consumption has stabilized.

MIL-L-22851 Ashless Dispersant Oil: This oil **must be used** after first 50 hours or oil consumption has stabilized.

Recommended Viscosity For Temperature Range:

MIL-L-6082 Aviation Grade Straight Mineral Oil:

All temperatures, use SAE 20W-50 or

Above 16°C (60°F), use SAE 50

-1°C (30°F) to 32°C (90°F), use SAE 40

-18°C (0°F) to 21°C (70°F), use SAE 30

Below -12°C (10°F), use SAE 20

MIL-L-22851 Ashless Dispersant Oil:

All temperatures, use SAE 20W-50 or

Above 16°C (60°F), use SAE 40 or SAE 50

-1°C (30°F) to 32°C (90°F), use SAE 40

-18°C (0°F) to 21°C (70°F), use SAE 40 or SAE 30

Below -12°C (10°F), use SAE 30

Oil Capacity:

Sump: 8 Quarts.

Total: 9 Quarts.

MAXIMUM CERTIFICATED WEIGHTS

Ramp: 3112 lbs.

Takeoff: 3100 lbs.

Landing: 3100 lbs.

Weight in Baggage Compartment:

Baggage Area "A" (or passenger on child's seat) - Station 82 to 110: 120 lbs. See note below.

Baggage Area "B" - Station 110 to 134: 80 lbs. See note below.

NOTE

The maximum combined weight capacity for baggage areas A and B is 200 lbs.

STANDARD AIRPLANE WEIGHTS

Standard Empty Weight, Skylane RG: 1752 lbs.

Skylane RG II: 1805 lbs.

Maximum Useful Load, Skylane RG: 1360 lbs.

Skylane RG II: 1307 lbs.

CABIN AND ENTRY DIMENSIONS

Detailed dimensions of the cabin interior and entry door openings are illustrated in Section 6.

BAGGAGE SPACE AND ENTRY DIMENSIONS

Dimensions of the baggage area and baggage door opening are illustrated in detail in Section 6.

SPECIFIC LOADINGS

Wing Loading: 17.8 lbs./sq. ft.

Power Loading: 13.2 lbs./hp.

SYMBOLS, ABBREVIATIONS AND TERMINOLOGY

GENERAL AIRSPEED TERMINOLOGY AND SYMBOLS

KCAS	Knots Calibrated Airspeed is indicated airspeed corrected for position and instrument error and expressed in knots. Knots calibrated airspeed is equal to KTAS in standard atmosphere at sea level.
KIAS	Knots Indicated Airspeed is the speed shown on the airspeed indicator and expressed in knots.
KTAS	Knots True Airspeed is the airspeed expressed in knots relative to undisturbed air which is KCAS corrected for altitude and temperature.
V_A	Maneuvering Speed is the maximum speed at which you may use abrupt control travel.
V_{FE}	Maximum Flap Extended Speed is the highest speed permissible with wing flaps in a prescribed extended position.
V_{LE}	Maximum Landing Gear Extended Speed is the maximum speed at which an airplane can be safely flown with the landing gear extended.
V_{LO}	Maximum Landing Gear Operating Speed is the maximum speed at which the landing gear can be safely extended or retracted.
V_{NO}	Maximum Structural Cruising Speed is the speed that should not be exceeded except in smooth air, then only with caution.
V_{NE}	Never Exceed Speed is the speed limit that may not be exceeded at any time.
V_S	Stalling Speed or the minimum steady flight speed at which the airplane is controllable.
V_{S_0}	Stalling Speed or the minimum steady flight speed at which the airplane is controllable in the landing configuration at the most forward center of gravity.

V_X **Best Angle-of-Climb Speed** is the speed which results in the greatest gain of altitude in a given horizontal distance.

V_Y **Best Rate-of-Climb Speed** is the speed which results in the greatest gain in altitude in a given time.

METEOROLOGICAL TERMINOLOGY

OAT **Outside Air Temperature** is the free air static temperature. It is expressed in either degrees Celsius or degrees Fahrenheit.

Standard Temperature **Standard Temperature** is 15°C at sea level pressure altitude and decreases by 2°C for each 1000 feet of altitude.

Pressure Altitude **Pressure Altitude** is the altitude read from an altimeter when the altimeter's barometric scale has been set to 29.92 inches of mercury (1013 mb).

ENGINE POWER TERMINOLOGY

BHP **Brake Horsepower** is the power developed by the engine.

RPM **Revolutions Per Minute** is engine speed.

MP **Manifold Pressure** is a pressure measured in the engine's induction system and is expressed in inches of mercury (Hg).

AIRPLANE PERFORMANCE AND FLIGHT PLANNING TERMINOLOGY

Demonstrated Crosswind Velocity **Demonstrated Crosswind Velocity** is the velocity of the crosswind component for which adequate control of the airplane during takeoff and landing was actually demonstrated during certification tests. The value shown is not considered to be limiting.

Usable Fuel **Usable Fuel** is the fuel available for flight planning.

Unusable Fuel **Unusable Fuel** is the quantity of fuel that can not be safely used in flight.

GPH **Gallons Per Hour** is the amount of fuel consumed per hour.

- NMPG** **Nautical Miles Per Gallon** is the distance which can be expected per gallon of fuel consumed at a specific engine power setting and/or flight configuration.
- g** **g** is acceleration due to gravity.

WEIGHT AND BALANCE TERMINOLOGY

- Reference Datum** **Reference Datum** is an imaginary vertical plane from which all horizontal distances are measured for balance purposes.
- Station** **Station** is a location along the airplane fuselage given in terms of the distance from the reference datum.
- Arm** **Arm** is the horizontal distance from the reference datum to the center of gravity (C.G.) of an item.
- Moment** **Moment** is the product of the weight of an item multiplied by its arm. (Moment divided by the constant 1000 is used in this handbook to simplify balance calculations by reducing the number of digits.)
- Center of Gravity (C.G.)** **Center of Gravity** is the point at which an airplane, or equipment, would balance if suspended. Its distance from the reference datum is found by dividing the total moment by the total weight of the airplane.
- C.G. Arm** **Center of Gravity Arm** is the arm obtained by adding the airplane's individual moments and dividing the sum by the total weight.
- C.G. Limits** **Center of Gravity Limits** are the extreme center of gravity locations within which the airplane must be operated at a given weight.
- Standard Empty Weight** **Standard Empty Weight** is the weight of a standard airplane, including unusable fuel, full operating fluids and full engine oil.
- Basic Empty Weight** **Basic Empty Weight** is the standard empty weight plus the weight of optional equipment.
- Useful Load** **Useful Load** is the difference between ramp weight and the basic empty weight.

Maximum
Ramp
Weight

Maximum Ramp Weight is the maximum weight approved for ground maneuver. (It includes the weight of start, taxi and runup fuel.)

Maximum
Takeoff
Weight

Maximum Takeoff Weight is the maximum weight approved for the start of the takeoff run.

Maximum
Landing
Weight

Maximum Landing Weight is the maximum weight approved for the landing touchdown.

Tare

Tare is the weight of chocks, blocks, stands, etc. used when weighing an airplane, and is included in the scale readings. Tare is deducted from the scale reading to obtain the actual (net) airplane weight.

SECTION 2 LIMITATIONS

TABLE OF CONTENTS

	Page
Introduction	2-3
Airspeed Limitations	2-4
Airspeed Indicator Markings	2-4
Power Plant Limitations	2-5
Power Plant Instrument Markings	2-6
Weight Limits	2-7
Center Of Gravity Limits	2-7
Maneuver Limits	2-7
Flight Load Factor Limits	2-7
Kinds Of Operation Limits	2-8
Fuel Limitations	2-8
Other Limitations	2-8
Flap Limitations	2-8
Placards	2-9

INTRODUCTION

Section 2 includes operating limitations, instrument markings, and basic placards necessary for the safe operation of the airplane, its engine, standard systems and standard equipment. The limitations included in this section and in Section 9 have been approved by the Federal Aviation Administration. Observance of these operating limitations is required by Federal Aviation Regulations.

NOTE

Refer to Section 9 of this Pilot's Operating Handbook for amended operating limitations, operating procedures, performance data and other necessary information for airplanes equipped with specific options.

NOTE

The airspeeds listed in the Airspeed Limitations chart (figure 2-1) and the Airspeed Indicator Markings chart (figure 2-2) are based on Airspeed Calibration data shown in Section 5 with the normal static source, with the exception of the bottom of the green and white arcs on the airspeed indicator. These are based on a power-off airspeed calibration. If the alternate static source is being used, ample margins should be observed to allow for the airspeed calibration variations between the normal and alternate static sources as shown in Section 5.

Your Cessna is certificated under FAA Type Certificate No. 3A13 as Cessna Model No. R182.

AIRSPEED LIMITATIONS

Airspeed limitations and their operational significance are shown in figure 2-1.

	SPEED	KCAS	KIAS	REMARKS
V _{NE}	Never Exceed Speed	175	181	Do not exceed this speed in any operation.
V _{NO}	Maximum Structural Cruising Speed	155	159	Do not exceed this speed except in smooth air, and then only with caution.
V _A	Maneuvering Speed: 3100 Pounds 2550 Pounds 2000 Pounds	111 100 89	112 101 89	Do not make full or abrupt control movements above this speed.
V _{FE}	Maximum Flap Extended Speed: To 10° Flaps 10° - 40° Flaps	137 96	140 95	Do not exceed these speeds with the given flap settings.
V _{LO}	Maximum Landing Gear Operating Speed	137	140	Do not extend or retract landing gear above this speed.
V _{LE}	Maximum Landing Gear Extended Speed	137	140	Do not exceed this speed with landing gear extended.
	Maximum Window Open Speed	175	181	Do not exceed this speed with windows open.

Figure 2-1. Airspeed Limitations

AIRSPEED INDICATOR MARKINGS

Airspeed indicator markings and their color code significance are shown in figure 2-2.

MARKING	KIAS VALUE OR RANGE	SIGNIFICANCE
White Arc	39 - 95	Full Flap Operating Range. Lower limit is maximum weight V_{S0} in landing configuration. Upper limit is maximum speed permissible with flaps extended.
Green Arc	41 - 159	Normal Operating Range. Lower limit is maximum weight V_S at most forward C.G. with flaps retracted. Upper limit is maximum structural cruising speed.
Yellow Arc	159 - 181	Operations must be conducted with caution and only in smooth air.
Red Line	181	Maximum speed for all operations.

Figure 2-2. Airspeed Indicator Markings

POWER PLANT LIMITATIONS

Engine Manufacturer: Avco Lycoming.

Engine Model Number: O-540-J3C5D.

Maximum Power: 235 BHP rating.

Engine Operating Limits for Takeoff and Continuous Operations:

Maximum Engine Speed: 2400 RPM.

Maximum Cylinder Head Temperature: 500°F (260°C).

Maximum Oil Temperature: 245°F (118°C).

Oil Pressure, Minimum: 25 psi.

Maximum: 115 psi.

Fuel Pressure, Minimum: 0.5 psi.

Maximum: 8.0 psi.

Fuel Grade: See Fuel Limitations.

Oil Grade (Specification):

MIL-L-6082 Aviation Grade Straight Mineral Oil or MIL-L-22851
Ashless Dispersant Oil.

Propeller Manufacturer: McCauley Accessory Division.

Propeller Model Number 2-Bladed: B2D34C218/90DHB-8

3-Bladed: B3D32C407/82NDA-3.

Propeller Diameter, 2-Bladed Maximum: 82 inches.

2-Bladed Minimum: 80.5 inches.

3-Bladed Maximum: 79 inches.

3-Bladed Minimum: 78 inches.

Propeller Blade Angle at 30 Inch Station, 2-Bladed Low: 15.8°.
 2-Bladed High: 29.4°.
 3-Bladed Low: 16.0°.
 3-Bladed High: 31.7°.

POWER PLANT INSTRUMENT MARKINGS

Power plant instrument markings and their color code significance are shown in figure 2-3.

INSTRUMENT	RED LINE	GREEN ARC	RED LINE
	MINIMUM LIMIT	NORMAL OPERATING	MAXIMUM LIMIT
Tachometer	---	2100 - 2400 RPM	2400 RPM
Manifold Pressure	---	15-23 in.Hg	---
Oil Temperature	---	100°-245°F	245°F
Cylinder Head Temperature	---	200° - 500°F	500°F
Fuel Pressure	0.5 psi	0.5 - 8.0 psi	8.0 psi
Oil Pressure	25 psi	60-90 psi	115 psi
Suction	---	4.5 - 5.4 in. Hg	---
Fuel Quantity	E (2 Gal. Unusable Each Tank)	---	---

Figure 2-3. Power Plant Instrument Markings

WEIGHT LIMITS

Maximum Ramp Weight: 3112 lbs.

Maximum Takeoff Weight: 3100 lbs.

Maximum Landing Weight: 3100 lbs.

Maximum Weight in Baggage Compartment:

Baggage Area "A" (or passenger on child's seat) - Station 82 to 110:120 lbs. See note below.

Baggage Area "B" - Station 110 to 134: 80 lbs. See note below.

NOTE

The maximum combined weight capacity for baggage areas A and B is 200 lbs.

CENTER OF GRAVITY LIMITS

Center of Gravity Range:

Forward: 33.0 inches aft of datum at 2250 lbs. or less, with straight line variation to 35.5 inches aft of datum at 2700 lbs., with straight line variation to 40.9 inches aft of datum at 3100 lbs.

Aft: 46.0 inches aft of datum at all weights.

Moment Change Due To Retracting Landing Gear: +3052 lb.-ins.

Reference Datum: Front face of firewall.

MANEUVER LIMITS

This airplane is certificated in the normal category. The normal category is applicable to aircraft intended for non-aerobatic operations. These include any maneuvers incidental to normal flying, stalls (except whip stalls), lazy eights, chandelles, and steep turns in which the angle of bank is not more than 60°.

Aerobatic maneuvers, including spins, are not approved.

FLIGHT LOAD FACTOR LIMITS

Flight Load Factors:

*Flaps Up: +3.8g, -1.52g

*Flaps Down: +2.0g

*The design load factors are 150% of the above, and in all cases, the structure meets or exceeds design loads.

KINDS OF OPERATION LIMITS

The airplane is equipped for day VFR and may be equipped for night VFR and/or IFR operations. FAR Part 91 establishes the minimum required instrumentation and equipment for these operations. The reference to types of flight operations on the operating limitations placard reflects equipment installed at the time of Airworthiness Certificate issuance.

Flight into known icing conditions is prohibited.

FUEL LIMITATIONS

2 Standard Tanks: 46 U.S. gallons each.

Total Fuel: 92 U.S. gallons.

Usable Fuel (all flight conditions): 88 U.S. gallons.

Unusable Fuel: 4 U.S. gallons

NOTE

To ensure maximum fuel capacity when refueling, and minimize cross-feeding when parked on a sloping surface, place the fuel selector valve in either LEFT or RIGHT position.

Takeoff and land with the fuel selector valve handle in the BOTH position.

Operation on either left or right tank is limited to level flight only.

With 1/4 tank or less, prolonged uncoordinated flight is prohibited when operating on either left or right tank in level flight.

Approved Fuel Grades (and Colors):

100LL Grade Aviation Fuel (Blue).

100 (Formerly 100/130) Grade Aviation Fuel (Green).

OTHER LIMITATIONS

FLAP LIMITATIONS

Approved Takeoff Range: 0° to 20°.

Approved Landing Range: 0° to 40°.

PLACARDS

The following information must be displayed in the form of composite or individual placards.

1. In full view of the pilot: (The "DAY-NIGHT-VFR-IFR" entry, shown on the example below, will vary as the airplane is equipped.)

The markings and placards installed in this airplane contain operating limitations which must be complied with when operating this airplane in the Normal Category. Other operating limitations which must be complied with when operating this airplane in this category are contained in the Pilot's Operating Handbook and FAA Approved Airplane Flight Manual.

No acrobatic maneuvers, including spins, approved.

Flight into known icing conditions prohibited.

This airplane is certified for the following flight operations as of date of original airworthiness certificate:

DAY-NIGHT-VFR-IFR

2. Near airspeed indicator:

<u>MAX SPEED - KIAS</u>	
MANEUVER	. . 112
GEAR OPER	. . 140
GEAR DOWN	. . 140

3. On control lock:

CONTROL LOCK - REMOVE BEFORE STARTING ENGINE.

4. On the fuel selector valve:

OFF
LEFT - 44 GAL. LEVEL FLIGHT ONLY
BOTH - 88 GAL. ALL FLIGHT ATTITUDES
BOTH ON FOR TAKEOFF AND LANDING
RIGHT - 44 GAL. LEVEL FLIGHT ONLY

5. On the baggage door:

120 POUNDS MAXIMUM
BAGGAGE AND/OR AUXILIARY PASSENGER
FORWARD OF BAGGAGE DOOR LATCH AND
80 POUNDS MAXIMUM
BAGGAGE AFT OF BAGGAGE DOOR LATCH
MAXIMUM 200 POUNDS COMBINED
FOR ADDITIONAL LOADING INSTRUCTIONS
SEE WEIGHT AND BALANCE DATA

6. On flap position indicator:

0° to 10°	(Partial flap range with blue color code and 140 kt callout; also, mechanical detent at 10°.)
10° to Full	White color code and 95 kt callout; also, mechanical detent at 20°.)

7. Forward of fuel tank filler cap:

FUEL
100LL/100 MIN GRADE AVIATION GASOLINE
CAP. 46.0 U.S. GAL.
CAP. 34.5 U.S. GAL. TO BOTTOM OF FILLER NECK

8. Near gear hand pump:

MANUAL
GEAR EXTENSION
1. SELECT GEAR DOWN
2. PULL HANDLE FWD
3. PUMP VERTICALLY
CAUTION
DO NOT PUMP WITH
GEAR UP SELECTED

9. A calibration card is provided to indicate the accuracy of the magnetic compass in 30° increments.

10. On oil filler cap:

OIL
8 QTS

11. Forward of each fuel tank filler cap in line with fwd arrow:

FUEL CAP FWD ▲ ARROW ALIGNMENT
CAP MUST NOT ROTATE DURING CLOSING

SECTION 3

EMERGENCY PROCEDURES

TABLE OF CONTENTS

	Page
Introduction	3-3
Airspeeds For Emergency Operation	3-3

OPERATIONAL CHECKLISTS

Engine Failures	3-3
Engine Failure During Takeoff Run	3-3
Engine Failure Immediately After Takeoff	3-4
Engine Failure During Flight	3-4
Forced Landings	3-4
Emergency Landing Without Engine Power	3-4
Precautionary Landing With Engine Power	3-4
Ditching	3-5
Fires	3-5
During Start On Ground	3-5
Engine Fire In Flight	3-6
Electrical Fire In Flight	3-6
Cabin Fire	3-7
Wing Fire	3-7
Icing	3-7
Inadvertent Icing Encounter	3-7
Static Source Blockage (Erroneous Instrument Reading Suspected)	3-8
Landing Gear Malfunction Procedures	3-8
Landing Gear Fails To Retract	3-8
Landing Gear Fails To Extend	3-8
Gear Up Landing	3-9
Landing Without Positive Indication Of Gear Locking	3-9
Landing With A Defective Nose Gear (Or Flat Nose Tire)	3-9
Landing With A Flat Main Tire	3-10
Electrical Power Supply System Malfunctions	3-10
Ammeter Shows Excessive Rate of Charge (Full Scale Deflection)	3-10
Low-Voltage Light Illuminates During Flight (Ammeter Indicates Discharge)	3-10

TABLE OF CONTENTS (Continued)

	Page
AMPLIFIED PROCEDURES	
Engine Failure	3-11
Forced Landings	3-12
Landing Without Elevator Control	3-12
Fires	3-12
Emergency Operation In Clouds (Vacuum System Failure)	3-13
Executing A 180° Turn In Clouds	3-13
Emergency Descent Through Clouds	3-13
Recovery From A Spiral Dive	3-14
Inadvertent Flight Into Icing Conditions	3-14
Static Source Blocked	3-14
Spins	3-15
Rough Engine Operation Or Loss Of Power	3-16
Carburetor Icing	3-16
Spark Plug Fouling	3-16
Magneto Malfunction	3-16
Engine-Driven Fuel Pump Failure	3-16
Low Oil Pressure	3-16
Landing Gear Malfunction Procedures	3-17
Retraction Malfunctions	3-17
Extension Malfunctions	3-17
Gear Up Landing	3-18
Electrical Power Supply System Malfunctions	3-18
Excessive Rate Of Charge	3-18
Insufficient Rate Of Charge	3-19

INTRODUCTION

Section 3 provides checklist and amplified procedures for coping with emergencies that may occur. Emergencies caused by airplane or engine malfunctions are extremely rare if proper preflight inspections and maintenance are practiced. Enroute weather emergencies can be minimized or eliminated by careful flight planning and good judgment when unexpected weather is encountered. However, should an emergency arise, the basic guidelines described in this section should be considered and applied as necessary to correct the problem. Emergency procedures associated with ELT and other optional systems can be found in Section 9.

AIRSPEEDS FOR EMERGENCY OPERATION

Engine Failure After Takeoff:

Wing Flaps Up	70 KIAS
Wing Flaps Down	65 KIAS

Maneuvering Speed:

3100 Lbs	112 KIAS
2550 Lbs	101 KIAS
2000 Lbs	89 KIAS

Maximum Glide:

3100 Lbs	80 KIAS
2550 Lbs	72 KIAS
2000 Lbs	64 KIAS

Precautionary Landing With Engine Power 65 KIAS

Landing Without Engine Power:

Wing Flaps Up	70 KIAS
Wing Flaps Down	65 KIAS

OPERATIONAL CHECKLISTS

ENGINE FAILURES

ENGINE FAILURE DURING TAKEOFF RUN

1. Throttle -- IDLE.
2. Brakes -- APPLY.
3. Wing Flaps -- RETRACT.
4. Mixture -- IDLE CUT-OFF.
5. Ignition Switch -- OFF.
6. Master Switch -- OFF.

ENGINE FAILURE IMMEDIATELY AFTER TAKEOFF

1. Airspeed -- 70 KIAS (flaps UP).
65 KIAS (flaps DOWN).
2. Mixture -- IDLE CUT-OFF.
3. Fuel Selector Valve -- OFF.
4. Ignition Switch -- OFF.
5. Wing Flaps -- AS REQUIRED (40° recommended).
6. Master Switch -- OFF.

ENGINE FAILURE DURING FLIGHT

1. Airspeed -- 80 KIAS.
2. Carburetor Heat -- ON.
3. Fuel Selector Valve -- BOTH
4. Mixture -- RICH.
5. Ignition Switch -- BOTH (or START if propeller is stopped).
6. Primer -- IN and LOCKED.

FORCED LANDINGS

EMERGENCY LANDING WITHOUT ENGINE POWER

1. Airspeed -- 70 KIAS (flaps UP).
65 KIAS (flaps DOWN).
2. Mixture -- IDLE CUT-OFF.
3. Fuel Selector Valve -- OFF.
4. Ignition Switch -- OFF.
5. Landing Gear -- DOWN (UP if terrain is rough or soft).
6. Wing Flaps -- AS REQUIRED (40° recommended).
7. Doors -- UNLATCH PRIOR TO TOUCHDOWN.
8. Master Switch -- OFF when landing is assured.
9. Touchdown -- SLIGHTLY TAIL LOW.
10. Brakes -- APPLY HEAVILY.

PRECAUTIONARY LANDING WITH ENGINE POWER

1. Airspeed -- 65 KIAS.
2. Wing Flaps -- 20°.
3. Selected Field -- FLY OVER, noting terrain and obstructions, then retract flaps upon reaching a safe altitude and airspeed.
4. Electrical Switches -- OFF.
5. Landing Gear -- DOWN (UP if terrain is rough or soft).
6. Wing Flaps -- 40° (on final approach).
7. Airspeed -- 65 KIAS.

8. Doors -- UNLATCH PRIOR TO TOUCHDOWN.
9. Avionics Power and Master Switches -- OFF.
10. Touchdown -- SLIGHTLY TAIL LOW.
11. Ignition Switch -- OFF.
12. Brakes -- APPLY HEAVILY.

DITCHING

1. Radio -- TRANSMIT MAYDAY on 121.5 MHz, giving location and intentions and SQUAWK 7700 if transponder is installed.
2. Heavy Objects (in baggage area) -- SECURE OR JETTISON.
3. Landing Gear -- UP.
4. Flaps -- 20° - 40°.
5. Power -- ESTABLISH 300 FT/MIN DESCENT at 60 KIAS.
6. Approach -- High Winds, Heavy Seas -- INTO THE WIND.
Light Winds, Heavy Swells -- PARALLEL TO SWELLS.

NOTE

If no power is available, approach at 70 KIAS with flaps up or at 65 KIAS with 10° flaps.

7. Cabin Doors -- UNLATCH.
8. Touchdown -- LEVEL ATTITUDE AT ESTABLISHED DESCENT.
9. Face -- CUSHION at touchdown with folded coat.
10. Airplane -- EVACUATE through cabin doors. If necessary, open windows and flood cabin to equalize pressure so doors can be opened.
11. Life Vests and Raft -- INFLATE.

FIRES

DURING START ON GROUND

1. Cranking -- CONTINUE, to get a start which would suck the flames and accumulated fuel through the carburetor and into the engine.

If engine starts:

2. Power -- 1700 RPM for a few minutes.
3. Engine -- SHUTDOWN and inspect for damage.

If engine fails to start:

4. Throttle -- FULL OPEN.

5. Mixture -- IDLE CUT-OFF.
6. Cranking -- CONTINUE.
7. Fire Extinguisher -- OBTAIN (have ground attendants obtain if not installed).
8. Engine -- SECURE.
 - a. Master Switch -- OFF.
 - b. Ignition Switch -- OFF.
 - c. Fuel Selector Valve -- OFF.
9. Fire -- EXTINGUISH using fire extinguisher, wool blanket, or dirt.
10. Fire Damage -- INSPECT, repair damage or replace damaged components or wiring before conducting another flight.

ENGINE FIRE IN FLIGHT

1. Mixture -- IDLE CUT-OFF.
2. Fuel Selector Valve -- OFF.
3. Master Switch -- OFF.
4. Cabin Heat and Air -- OFF (except overhead vents).
5. Airspeed -- 100 KIAS (If fire is not extinguished, increase glide speed to find an airspeed which will provide an incombustible mixture).
6. Forced Landing -- EXECUTE (as described in Emergency Landing Without Engine Power).

ELECTRICAL FIRE IN FLIGHT

1. Master Switch -- OFF.
2. Avionics Power Switch -- OFF.
3. All Other Switches (except ignition switch) -- OFF.
4. Vents/Cabin Air/Heat -- CLOSED.
5. Fire Extinguisher -- ACTIVATE (if available).

WARNING

After discharging an extinguisher within a closed cabin, ventilate the cabin.

If fire appears out and electrical power is necessary for continuance of flight:

6. Master Switch -- ON.
7. Circuit Breakers -- CHECK for faulty circuit, do not reset.
8. Radio Switches -- OFF.
9. Avionics Power Switch -- ON.
10. Radio/Electrical Switches -- ON one at a time, with delay after each until short circuit is localized.

11. Vents/Cabin Air/Heat -- OPEN when it is ascertained that fire is completely extinguished.

CABIN FIRE

1. Master Switch -- OFF.
2. Vents/Cabin Air/Heat -- CLOSED (to avoid drafts).
3. Fire Extinguisher -- ACTIVATE (if available).

WARNING

After discharging an extinguisher within a closed cabin, ventilate the cabin.

4. Land the airplane as soon as possible to inspect for damage.

WING FIRE

1. Navigation Light Switch -- OFF.
2. Strobe Light Switch (if installed) -- OFF.
3. Pitot Heat Switch (if installed) -- OFF.

NOTE

Perform a sideslip to keep the flames away from the fuel tank and cabin, and land as soon as possible using flaps only as required for final approach and touchdown.

ICING

INADVERTENT ICING ENCOUNTER

1. Turn pitot heat switch ON (if installed).
2. Turn back or change altitude to obtain an outside air temperature that is less conducive to icing.
3. Pull cabin heat control full out and rotate defroster control clockwise to obtain maximum defroster airflow.
4. Increase engine speed to minimize ice build-up on propeller blades.
5. Watch for signs of carburetor air filter ice and apply carburetor heat as required. An unexplained loss in manifold pressure could be caused by carburetor ice or air intake filter ice. Lean the mixture if carburetor heat is used continuously.

6. Plan a landing at the nearest airport. With an extremely rapid ice build-up, select a suitable "off airport" landing site.
7. With an ice accumulation of 1/4 inch or more on the wing leading edges, be prepared for significantly higher stall speed.
8. Leave wing flaps retracted. With a severe ice build-up on the horizontal tail, the change in wing wake airflow direction caused by wing flap extension could result in a loss of elevator effectiveness.
9. Open the window and, if practical, scrape ice from a portion of the windshield for visibility in the landing approach.
10. Perform a landing approach using a forward slip, if necessary, for improved visibility.
11. Approach at 85 to 95 KIAS, depending upon the amount of ice accumulation.
12. Perform a landing in level attitude.

STATIC SOURCE BLOCKAGE (Erroneous Instrument Reading Suspected)

1. Static Pressure Alternate Source Valve (if installed) -- PULL ON.
2. Airspeed -- Consult appropriate table in Section 5.
3. Altitude -- Cruise 50 feet higher than normal.

LANDING GEAR MALFUNCTION PROCEDURES

LANDING GEAR FAILS TO RETRACT

1. Master Switch -- ON.
2. Landing Gear Lever -- CHECK (lever full up).
3. Landing Gear and Gear Pump Circuit Breakers -- IN.
4. Gear Up Light -- CHECK.
5. Landing Gear Lever -- RECYCLE.
6. Gear Motor -- CHECK operation (ammeter and noise).

LANDING GEAR FAILS TO EXTEND

1. Landing Gear Lever -- DOWN.
2. Emergency Hand Pump -- EXTEND HANDLE, and PUMP (perpendicular to handle until resistance becomes heavy -- about 20 cycles).
3. Gear Down Light -- ON.
4. Pump Handle -- STOW.

GEAR UP LANDING

1. Landing Gear Lever -- UP.
2. Landing Gear and Gear Pump Circuit Breakers -- IN.
3. Runway -- SELECT longest hard surface or smooth sod runway available.
4. Wing Flaps -- 40° (on final approach).
5. Airspeed -- 65 KIAS.
6. Doors -- UNLATCH PRIOR TO TOUCHDOWN.
7. Avionics Power and Master Switches -- OFF when landing is assured.
8. Touchdown -- SLIGHTLY TAIL LOW.
9. Mixture -- IDLE CUT-OFF.
10. Ignition Switch -- OFF.
11. Fuel Selector Valve -- OFF.
12. Airplane -- EVACUATE.

LANDING WITHOUT POSITIVE INDICATION OF GEAR LOCKING

1. Before Landing Check -- COMPLETE.
2. Approach -- NORMAL (full flap).
3. Landing Gear and Gear Pump Circuit Breakers -- IN.
4. Landing -- TAIL LOW as smoothly as possible.
5. Braking -- MINIMUM necessary.
6. Taxi -- SLOWLY.
7. Engine -- SHUTDOWN before inspecting gear.

LANDING WITH A DEFECTIVE NOSE GEAR (Or Flat Nose Tire)

1. Movable Load -- TRANSFER to baggage area.
2. Passenger -- MOVE to rear seat.
3. Before Landing Checklist -- COMPLETE.
4. Runway -- HARD SURFACE or SMOOTH SOD.
5. Wing Flaps -- 40°
6. Cabin Doors -- UNLATCH PRIOR TO TOUCHDOWN.
7. Avionics Power and Master Switches -- OFF when landing is assured.
8. Land -- SLIGHTLY TAIL LOW.
9. Mixture -- IDLE CUT-OFF.
10. Ignition Switch -- OFF.
11. Fuel Selector Valve -- OFF.
12. Elevator Control -- HOLD NOSE OFF GROUND as long as possible.
13. Airplane -- EVACUATE as soon as it stops.

LANDING WITH A FLAT MAIN TIRE

1. Approach -- NORMAL (full flap).
2. Touchdown -- GOOD TIRE FIRST, hold airplane off flat tire as long as possible with aileron control.
3. Directional Control -- MAINTAIN using brake on good wheel as required.

ELECTRICAL POWER SUPPLY SYSTEM MALFUNCTIONS

AMMETER SHOWS EXCESSIVE RATE OF CHARGE (Full Scale Deflection)

1. Alternator -- OFF.
2. Alternator Circuit Breaker -- PULL.
3. Nonessential Electrical Equipment -- OFF.
4. Flight -- TERMINATE as soon as practical.

LOW-VOLTAGE LIGHT ILLUMINATES DURING FLIGHT (Ammeter Indicates Discharge)

NOTE

Illumination of the low-voltage light may occur during low RPM conditions with an electrical load on the system such as during a low RPM taxi. Under these conditions, the light will go out at higher RPM. The master switch need not be recycled since an over-voltage condition has not occurred to de-activate the alternator system. Momentary illumination and/or ammeter needle deflection may also occur during startup of the landing gear system hydraulic pump motor.

1. Avionics Power Switch -- OFF.
2. Alternator Circuit Breaker -- CHECK IN.
3. Master Switch -- OFF (both sides).
4. Master Switch -- ON.
5. Low-Voltage Light -- CHECK OFF.
6. Avionics Power Switch -- ON.

If low-voltage light illuminates again:

7. Alternator -- OFF.
8. Nonessential Radio and Electrical Equipment -- OFF.
9. Flight -- TERMINATE as soon as practical.

AMPLIFIED PROCEDURES

ENGINE FAILURE

If an engine failure occurs during the takeoff run, the most important thing to do is stop the airplane on the remaining runway. Those extra items on the checklist will provide added safety after a failure of this type.

Prompt lowering of the nose to maintain airspeed and establish a glide attitude is the first response to an engine failure after takeoff. In most cases, the landing should be planned straight ahead with only small changes in direction to avoid obstructions. Altitude and airspeed are seldom sufficient to execute a 180° gliding turn necessary to return to the runway. The checklist procedures assume that adequate time exists to secure the fuel and ignition systems prior to touchdown.

After an engine failure in flight, the best glide speed as shown in figure 3-1 should be established as quickly as possible. While gliding toward a suitable landing area, an effort should be made to identify the cause of the failure. If time permits, an engine restart should be attempted as shown in

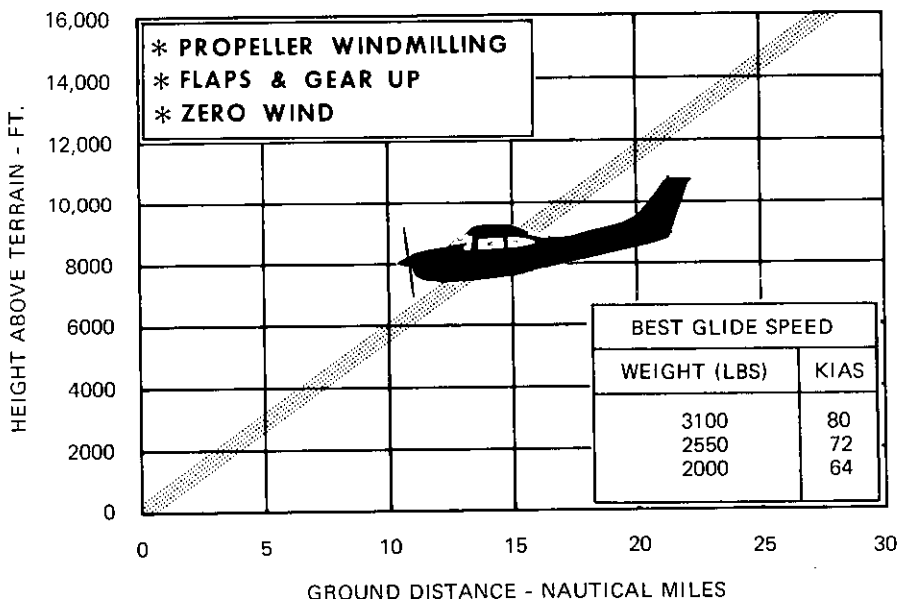

Figure 3-1. Maximum Glide

the checklist. If the engine cannot be restarted, a forced landing without power must be completed.

FORCED LANDINGS

If all attempts to restart the engine fail and a forced landing is imminent, select a suitable field and prepare for the landing as discussed in the checklist for Emergency Landing Without Engine Power.

Before attempting an "off airport" landing with engine power available, one should fly over the landing area at a safe but low altitude to inspect the terrain for obstructions and surface conditions, proceeding as discussed under the Precautionary Landing With Engine Power checklist.

Prepare for ditching by securing or jettisoning heavy objects located in the baggage area and collect folded coats for protection of occupants' face at touchdown. Transmit Mayday message on 121.5 MHz giving location and intentions and squawk 7700 if a transponder is installed. Avoid a landing flare because of difficulty in judging height over a water surface.

In a forced landing situation, do not turn off the avionics power and master switches until a landing is assured. Premature deactivation of the switches will disable the encoding altimeter and airplane electrical systems.

LANDING WITHOUT ELEVATOR CONTROL

Trim for horizontal flight with an airspeed of approximately 80 KIAS by using throttle and elevator trim control. Then **do not change the elevator trim control setting**; control the glide angle by adjusting power exclusively.

At flareout, the nose-down moment resulting from power reduction is an adverse factor and the airplane may hit on the nose wheel. Consequently, at flareout, the elevator trim control should be adjusted toward the full nose-up position and the power adjusted so that the airplane will rotate to the horizontal attitude for touchdown. Close the throttle at touchdown.

FIRES

Although engine fires are extremely rare in flight, the steps of the appropriate checklist should be followed if one is encountered. After completion of this procedure, execute a forced landing. Do not attempt to restart the engine.

The initial indication of an electrical fire is usually the odor of burning insulation. The checklist for this problem should result in elimination of the fire.

EMERGENCY OPERATION IN CLOUDS (Vacuum System Failure)

In the event of a vacuum system failure during flight, the directional indicator and attitude indicator will be disabled, and the pilot will have to rely on the turn coordinator if he inadvertently flies into clouds. The following instructions assume that only the electrically-powered turn coordinator is operative, and that the pilot is not completely proficient in instrument flying.

EXECUTING A 180° TURN IN CLOUDS

Upon inadvertently entering the clouds, an immediate plan should be made to turn back as follows:

1. Note the compass heading.
2. Note the time of the minute hand and observe the position of the sweep second hand on the clock.
3. When the sweep second hand indicates the nearest half-minute, initiate a standard rate left turn, holding the turn coordinator symbolic airplane wing opposite the lower left index mark for 60 seconds. Then roll back to level flight by leveling the miniature airplane.
4. Check accuracy of the turn by observing the compass heading which should be the reciprocal of the original heading.
5. If necessary, adjust heading primarily with skidding motions rather than rolling motions so that the compass will read more accurately.
6. Maintain altitude and airspeed by cautious application of elevator control. Avoid overcontrolling by keeping the hands off the control wheel as much as possible and steering only with rudder.

EMERGENCY DESCENT THROUGH CLOUDS

If conditions preclude reestablishment of VFR flight by a 180° turn, a descent through a cloud deck to VFR conditions may be appropriate. If possible, obtain radio clearance for an emergency descent through clouds. To guard against a spiral dive, choose an easterly or westerly heading to minimize compass card swings due to changing bank angles. In addition, keep hands off the control wheel and steer a straight course with rudder control by monitoring the turn coordinator. Occasionally check the compass heading and make minor corrections to hold an approximate

course. Before descending into the clouds, set up a stabilized let-down condition as follows:

1. Extend landing gear.
2. Apply full rich mixture.
3. Apply full carburetor heat.
4. Reduce power to set up a 500 to 800 ft/min rate of descent.
5. Adjust the elevator and rudder trim control wheels for a stabilized descent at 80 KIAS.
6. Keep hands off control wheel.
7. Monitor turn coordinator and make corrections by rudder alone.
8. Adjust rudder trim to relieve unbalanced rudder force, if present.
9. Check trend of compass card movement and make cautious corrections with rudder to stop turn.
10. Upon breaking out of clouds, resume normal cruising flight.

RECOVERY FROM A SPIRAL DIVE

If a spiral is encountered, proceed as follows:

1. Close the throttle.
2. Stop the turn by using coordinated aileron and rudder control to align the symbolic airplane in the turn coordinator with the horizon reference line.
3. Cautiously apply elevator back pressure to slowly reduce the indicated airspeed to 80 KIAS.
4. Adjust the elevator trim control to maintain an 80 KIAS glide.
5. Keep hands off the control wheel, using rudder control to hold a straight heading. Use rudder trim to relieve unbalanced rudder force, if present.
6. Apply carburetor heat.
7. Clear engine occasionally, but avoid using enough power to disturb the trimmed glide.
8. Upon breaking out of clouds, resume normal cruising flight.

INADVERTENT FLIGHT INTO ICING CONDITIONS

Flight into icing conditions is prohibited. An inadvertent encounter with these conditions can best be handled using the checklist procedures. The best procedure, of course, is to turn back or change altitude to escape icing conditions.

STATIC SOURCE BLOCKED

If erroneous readings of the static source instruments (airspeed, altimeter and vertical speed) are suspected, the static pressure alternate

source valve should be pulled on, thereby supplying static pressure to these instruments from the cabin. Cabin pressures will vary with open ventilators or windows and with airspeed. To avoid the possibility of large errors, the windows should not be open when using the alternate static source.

NOTE

In an emergency on airplanes not equipped with an alternate static source, cabin pressure can be supplied to the static pressure instruments by breaking the glass in the face of the vertical speed indicator.

A calibration table is provided in Section 5 to illustrate the effect of the alternate static source on indicated airspeeds. With the windows and vents closed the airspeed indicator may typically read as much as 1 knot slower in cruise. With the vents open, the airspeed indicator may typically read as much as 3 knots slower and the altimeter 50 feet lower in cruise. If the alternate static source must be used for landing, the normal indicated approach speed may be used since the indicated airspeed variations in this configuration are 2 knots or less.

SPINS

Intentional spins are prohibited in this airplane. Should an inadvertent spin occur, the following recovery procedure should be used:

1. RETARD THROTTLE TO IDLE POSITION.
2. PLACE AILERONS IN NEUTRAL POSITION.
3. APPLY AND HOLD FULL RUDDER OPPOSITE TO THE DIRECTION OF ROTATION.
4. JUST AFTER THE RUDDER REACHES THE STOP, MOVE THE WHEEL **BRISKLY** FORWARD FAR ENOUGH TO BREAK THE STALL. Full down elevator may be required at aft center of gravity loadings to assure optimum recoveries.
5. **HOLD** THESE CONTROL INPUTS UNTIL ROTATION STOPS. Premature relaxation of the control inputs may extend the recovery.
6. AS ROTATION STOPS, NEUTRALIZE RUDDER, AND MAKE A SMOOTH RECOVERY FROM THE RESULTING DIVE.

NOTE

If disorientation precludes a visual determination of the direction of rotation, the symbolic airplane in the turn coordinator may be referred to for this information.

ROUGH ENGINE OPERATION OR LOSS OF POWER

CARBURETOR ICING

An unexplained drop in manifold pressure and eventual engine roughness may result from the formation of carburetor ice. To clear the ice, apply full throttle and pull the carburetor heat knob full out until the engine runs smoothly; then remove carburetor heat and readjust the throttle. If conditions require the continued use of carburetor heat in cruise flight, use the minimum amount of heat necessary to prevent ice from forming and lean the mixture for smoothest engine operation.

SPARK PLUG FOULING

A slight engine roughness in flight may be caused by one or more spark plugs becoming fouled by carbon or lead deposits. This may be verified by turning the ignition switch momentarily from BOTH to either L or R position. An obvious power loss in single ignition operation is evidence of spark plug or magneto trouble. Assuming that spark plugs are the more likely cause, lean the mixture to the recommended lean setting for cruising flight. If the problem does not clear up in several minutes, determine if a richer mixture setting will produce smoother operation. If not, proceed to the nearest airport for repairs using the BOTH position of the ignition switch unless extreme roughness dictates the use of a single ignition position.

MAGNETO MALFUNCTION

A sudden engine roughness or misfiring is usually evidence of magneto problems. Switching from BOTH to either L or R ignition switch position will identify which magneto is malfunctioning. Select different power settings and enrichen the mixture to determine if continued operation on BOTH magnetos is practicable. If not, switch to the good magneto and proceed to the nearest airport for repairs.

ENGINE - DRIVEN FUEL PUMP FAILURE

In the event of an engine-driven fuel pump failure, gravity flow will provide sufficient fuel flow for level or descending flight. However, in a climbing attitude or anytime the fuel pressure drops to 0.5 PSI, the auxiliary fuel pump should be turned on.

LOW OIL PRESSURE

If low oil pressure is accompanied by normal oil temperature, there is a possibility the oil pressure gage or relief valve is malfunctioning. A leak

in the line to the gage is not necessarily cause for an immediate precautionary landing because an orifice in this line will prevent a sudden loss of oil from the engine sump. However, a landing at the nearest airport would be advisable to inspect the source of trouble.

If a total loss of oil pressure is accompanied by a rise in oil temperature, there is good reason to suspect an engine failure is imminent. Reduce engine power immediately and select a suitable forced landing field. Use only the minimum power required to reach the desired touchdown spot.

LANDING GEAR MALFUNCTION PROCEDURES

In the event of possible landing gear retraction or extension malfunctions, there are several general checks that should be made prior to initiating the steps outlined in the following paragraphs.

In analyzing a landing gear malfunction, first check that the master switch is ON and the LDG GEAR and GEAR PUMP circuit breakers are in, reset, if necessary. Also, check both landing gear position indicator lights for operation by "pressing-to-test" the light units and rotating them at the same time to check for open dimming shutters. A burned-out bulb can be replaced in flight by using the bulb from the remaining gear position indicator light.

RETRACTION MALFUNCTIONS

If the landing gear fails to retract normally, or an intermittent GEAR UP indicator light is present, check the indicator light for proper operation and attempt to recycle the landing gear. Place the landing gear lever in the GEAR DOWN position. When the GEAR DOWN light illuminates, reposition the gear lever in the GEAR UP position for another retraction attempt. If the GEAR UP indicator light still fails to illuminate, the flight may be continued to an airport having maintenance facilities, if practical. If gear motor operation is audible after a period of one minute following gear lever retraction actuation, pull the GEAR PUMP circuit breaker to prevent the electric motor from overheating. In this event, remember to re-engage the circuit breaker just prior to landing. Intermittent gear motor operation may also be detected by momentary fluctuations of the ammeter needle.

EXTENSION MALFUNCTIONS

Normal landing gear extension time is approximately 5 seconds. If the landing gear will not extend normally, perform the general checks of circuit breakers and master switch and repeat the normal extension

procedures at a reduced airspeed of 100 KIAS. The landing gear lever must be in the down position with the detent engaged. If efforts to extend and lock the gear through the normal landing gear system fail, the gear can be manually extended (as long as hydraulic system fluid has not been completely lost) by use of the emergency hand pump. The hand pump is located between the front seats.

A checklist is provided for step-by-step instructions for a manual gear extension.

If gear motor operation is audible after a period of one minute following gear lever extension actuation, pull the GEAR PUMP circuit breaker to prevent the electric motor from overheating. In this event, remember to re-engage the circuit breaker just prior to landing.

GEAR UP LANDING

If the landing gear remains retracted or is only partially extended, and all efforts to fully extend it (including manual extension) have failed, plan a wheels-up landing. In preparation for landing, reposition the landing gear lever to GEAR UP and push the LDG GEAR and GEAR PUMP circuit breakers in to allow the landing gear to swing into the gear wells at touchdown. Then proceed in accordance with the checklist.

ELECTRICAL POWER SUPPLY SYSTEM MALFUNCTIONS

Malfunctions in the electrical power supply system can be detected by periodic monitoring of the ammeter and low-voltage warning light; however, the cause of these malfunctions is usually difficult to determine. A broken alternator drive belt or wiring is most likely the cause of alternator failures, although other factors could cause the problem. A defective alternator control unit can also cause malfunctions. Problems of this nature constitute an electrical emergency and should be dealt with immediately. Electrical power malfunctions usually fall into two categories: excessive rate of charge and insufficient rate of charge. The paragraphs below describe the recommended remedy for each situation.

EXCESSIVE RATE OF CHARGE

After engine starting and heavy electrical usage at low engine speeds (such as extended taxiing) the battery condition will be low enough to accept above normal charging during the initial part of a flight. However, after thirty minutes of cruising flight, the ammeter should be indicating

less than two needle widths of charging current. If the charging rate were to remain above this value on a long flight, the battery would overheat and evaporate the electrolyte at an excessive rate.

Electronic components in the electrical system can be adversely affected by higher than normal voltage. The alternator control unit includes an over-voltage sensor which normally will automatically shut down the alternator if the charge voltage reaches approximately 31.5 volts. If the over-voltage sensor malfunctions, as evidenced by an excessive rate of charge shown on the ammeter, the alternator should be turned off, alternator circuit breaker pulled, nonessential electrical equipment turned off and the flight terminated as soon as practical.

INSUFFICIENT RATE OF CHARGE

NOTE

Illumination of the low-voltage light and ammeter discharge indications may occur during low RPM conditions with an electrical load on the system, such as during a low RPM taxi. Under these conditions, the light will go out at higher RPM. The master switch need not be recycled since an over-voltage condition has not occurred to de-activate the alternator system. Momentary illumination and/or ammeter needle deflection may also occur during startup of the landing gear system hydraulic pump motor.

If the over-voltage sensor should shut down the alternator or if the alternator output is low, a discharge rate will be shown on the ammeter followed by illumination of the low-voltage warning light. Since this may be a "nuisance" trip-out, an attempt should be made to reactivate the alternator system. To do this, turn the avionics power switch off, check that the alternator circuit breaker is in, then turn both sides of the master switch off and then on again. If the problem no longer exists, normal alternator charging will resume and the low-voltage light will go off. The avionics power switch may then be turned back on. If the light illuminates again, a malfunction is confirmed. In this event, the flight should be terminated and/or the current drain on the battery minimized because the battery can supply the electrical system for only a limited period of time. Battery power must be conserved for later operation of the landing gear and wing flaps and, if the emergency occurs at night, for possible use of the landing lights during landing.

SECTION 4

NORMAL PROCEDURES

TABLE OF CONTENTS

	Page
Introduction	4-3
Speeds For Normal Operation	4-3

CHECKLIST PROCEDURES

Preflight Inspection	4-5
Cabin	4-5
Empennage	4-5
Right Wing, Trailing Edge	4-5
Right Wing	4-5
Nose	4-6
Left Wing	4-6
Left Wing, Leading Edge	4-6
Left Wing, Trailing Edge	4-6
Before Starting Engine	4-7
Starting Engine	4-7
Before Takeoff	4-7
Takeoff	4-8
Normal Takeoff	4-8
Short Field Takeoff	4-9
Enroute Climb	4-9
Normal Climb	4-9
Maximum Performance Climb	4-9
Cruise	4-9
Descent	4-9
Before Landing	4-10
Landing	4-10
Normal Landing	4-10
Short Field Landing	4-10
Balked Landing	4-11
After Landing	4-11
Securing Airplane	4-11

TABLE OF CONTENTS (Continued)

	Page
AMPLIFIED PROCEDURES	
Starting Engine	4-13
Taxiing	4-13
Before Takeoff	4-15
Warm-Up	4-15
Magneto Check	4-15
Alternator Check	4-15
Takeoff	4-15
Power Check	4-15
Wing Flap Settings	4-16
Crosswind Takeoff	4-16
Landing Gear Retraction	4-16
Enroute Climb	4-17
Cruise	4-17
Leaning With A Cessna Economy Mixture Indicator (EGT)	4-19
Stalls	4-20
Before Landing	4-20
Landing	4-20
Normal Landing	4-20
Short Field Landing	4-20
Crosswind Landing	4-21
Balked Landing	4-21
Cold Weather Operation	4-21
Starting	4-21
Operation	4-23
Hot Weather Operation	4-23
Noise Characteristics	4-23

INTRODUCTION

Section 4 provides checklist and amplified procedures for the conduct of normal operation. Normal procedures associated with optional systems can be found in Section 9.

SPEEDS FOR NORMAL OPERATION

Unless otherwise noted, the following speeds are based on a maximum weight of 3100 pounds and may be used for any lesser weight. However, to achieve the performance specified in Section 5 for takeoff distance, the speed appropriate to the particular weight must be used.

Takeoff:

Normal Climb Out	70-80 KIAS
Short Field Takeoff, Flaps 20°, Speed at 50 Feet	59 KIAS

Enroute Climb, Flaps and Gear Up:

Normal	90-100 KIAS
Best Rate of Climb, Sea Level	88 KIAS
Best Rate of Climb, 10,000 Feet	75 KIAS
Best Angle of Climb, Sea Level	65 KIAS
Best Angle of Climb, 10,000 Feet	67 KIAS

Landing Approach:

Normal Approach, Flaps Up	70-80 KIAS
Normal Approach, Flaps 40°	65-75 KIAS
Short Field Approach, Flaps 40°	64 KIAS

Balked Landing:

Maximum Power, Flaps 20°	75 KIAS
------------------------------------	---------

Maximum Recommended Turbulent Air Penetration Speed:

3100 Lbs	112 KIAS
2550 Lbs	101 KIAS
2000 Lbs	89 KIAS

Maximum Demonstrated Crosswind Velocity:

Takeoff or Landing	18 KNOTS
------------------------------	----------

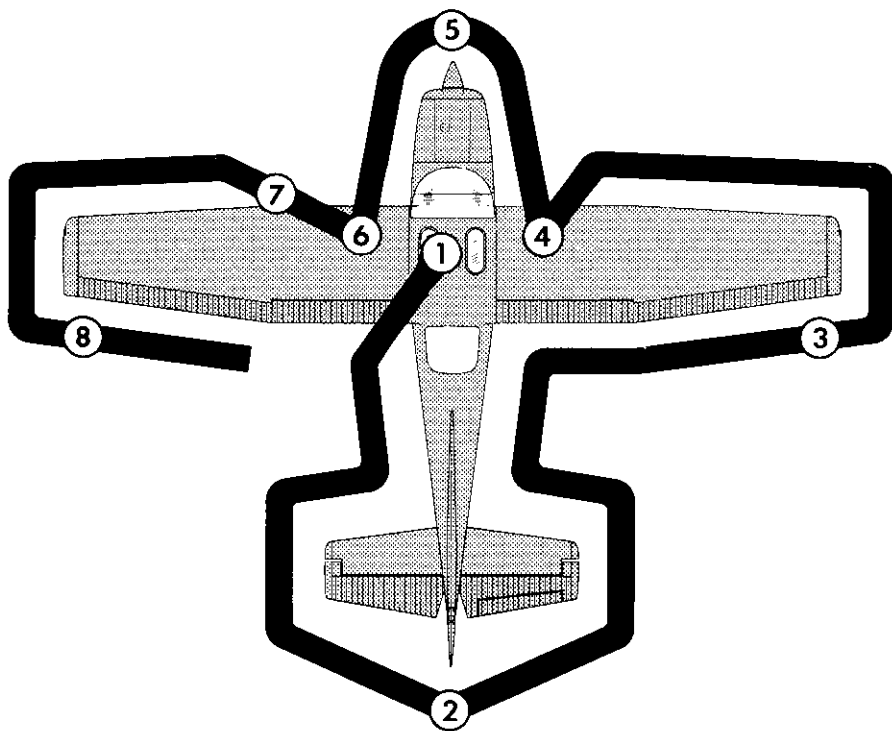

NOTE

Visually check airplane for general condition during walk-around inspection. In cold weather, remove even small accumulations of frost, ice or snow from wing, tail and control surfaces. Also, make sure that control surfaces contain no internal accumulations of ice or debris. Prior to flight, check that pitot heater (if installed) is warm to touch within 30 seconds with battery and pitot heat switches on. If a night flight is planned, check operation of all lights, and make sure a flashlight is available.

Figure 4-1. Preflight Inspection

CHECKLIST PROCEDURES

PREFLIGHT INSPECTION

① CABIN

1. Pilot's Operating Handbook -- AVAILABLE IN THE AIRPLANE.
2. Landing Gear Lever -- DOWN.
3. Control Wheel Lock -- REMOVE.
4. Ignition Switch -- OFF.
5. Avionics Power Switch -- OFF.
6. Master Switch -- ON.

WARNING

When turning on the master switch, using an external power source, or pulling the propeller through by hand, treat the propeller as if the ignition switch were on. Do not stand, nor allow anyone else to stand, within the arc of the propeller since a loose or broken wire or a component malfunction could cause the propeller to rotate.

7. Fuel Quantity Indicators -- CHECK QUANTITY.
8. Landing Gear Position Indicator Light (green) -- ILLUMINATED.
9. Avionics Cooling Fan -- CHECK AUDIBLY FOR OPERATION.
10. Master Switch -- OFF.
11. Fuel Selector Valve -- BOTH.
12. Static Pressure Alternate Source Valve (if installed) -- OFF.
13. Baggage Door -- CHECK for security, lock with key if child's seat is to be occupied.

② EMPENNAGE

1. Rudder Gust Lock -- REMOVE.
2. Tail Tie-Down -- DISCONNECT.
3. Control Surfaces -- CHECK freedom of movement and security.

③ RIGHT WING Trailing Edge

1. Aileron -- CHECK freedom of movement and security.

④ RIGHT WING

1. Wing Tie-Down -- DISCONNECT.
2. Fuel Tank Vent Opening -- CHECK for stoppage.

3. Main Wheel Tire -- CHECK for proper inflation.
4. Before first flight of the day and after each refueling, use sampler cup and drain small quantity of fuel from fuel tank sump quick-drain valve to check for water, sediment, and proper fuel grade.
5. Fuel Quantity -- CHECK VISUALLY for desired level.
6. Fuel Filler Cap -- SECURE and vent unobstructed.

⑤ NOSE

1. Static Source Openings (both sides of fuselage) --CHECK for stoppage.
2. Propeller and Spinner -- CHECK for nicks, security and oil leaks.
3. Landing Lights -- CHECK for condition and cleanliness.
4. Carburetor Air Inlet -- CHECK for restrictions .
5. Nose Wheel Strut and Tire -- CHECK for proper inflation.
6. Nose Tie-Down -- DISCONNECT.
7. Engine Oil Level -- CHECK. Do not operate with less than five quarts. Fill to eight quarts for extended flight.
8. Before first flight of the day and after each refueling, pull out strainer drain knob for about four seconds to clear fuel strainer of possible water and sediment. Check strainer drain closed. If water is observed, the fuel system may contain additional water, and further draining of the system at the strainer, fuel tank sumps, and fuel selector valve drain plug will be necessary.

⑥ LEFT WING

1. Main Wheel Tire -- CHECK for proper inflation.
2. Before first flight of day and after each refueling, use sampler cup and drain small quantity of fuel from fuel tank sump quick-drain valve to check for water, sediment and proper fuel grade.
3. Fuel Quantity -- CHECK VISUALLY for desired level.
4. Fuel Filler Cap -- SECURE and vent unobstructed.

⑦ LEFT WING Leading Edge

1. Pitot Tube Cover -- REMOVE and check opening for stoppage.
2. Fuel Tank Vent Opening -- CHECK for stoppage.
3. Stall Warning Vane -- CHECK for freedom of movement while master switch is momentarily turned ON (horn should sound when vane is pushed upward).
4. Wing Tie-Down -- DISCONNECT.

⑧ LEFT WING Trailing Edge

1. Aileron -- CHECK freedom of movement and security.

BEFORE STARTING ENGINE

1. Preflight Inspection -- COMPLETE.
2. Seats, Seat Belts, Shoulder Harnesses -- ADJUST and LOCK.
3. Fuel Selector Valve -- BOTH.
4. Avionics Power Switch, Autopilot (if installed), Electrical Equipment -- OFF.

CAUTION

The avionics power switch must be OFF during engine start to prevent possible damage to avionics.

5. Brakes -- TEST and SET.
6. Cowl Flaps -- OPEN (move lever out of locking hole to reposition).
7. Landing Gear Lever -- DOWN
8. Circuit Breakers -- CHECK IN.

STARTING ENGINE

1. Mixture -- RICH.
2. Propeller -- HIGH RPM.
3. Carburetor Heat -- COLD.
4. Throttle -- PUMP once, or as much as six times if engine is very hot; leave open 1/4 inch.
5. Master Switch -- ON.
6. Propeller Area -- CLEAR.
7. Ignition Switch -- START (release when engine starts).
8. Oil Pressure -- CHECK.
9. Flashing Beacon and Navigation Lights -- ON as required.
10. Avionics Power Switch -- ON.
11. Radios -- ON.

BEFORE TAKEOFF

1. Cabin Doors and Windows -- CLOSED and LOCKED.
2. Parking Brake -- SET.
3. Seats, Seat Belts, Shoulder Harnesses -- SECURE.
4. Flight Controls -- FREE and CORRECT.
5. Flight Instruments -- SET.
6. Fuel Selector Valve -- BOTH.
7. Mixture -- RICH.
8. Auxiliary Fuel Pump -- ON (check for rise in fuel pressure), then OFF.

NOTE

In flight, gravity feed will normally supply satisfactory fuel flow if the engine-driven fuel pump should fail. However, if a fuel pump failure in flight causes the fuel pressure to drop below 0.5 PSI, use the auxiliary fuel pump to assure proper engine operation.

9. Elevator and Rudder Trim -- TAKEOFF.
10. Throttle -- 1700 RPM.
 - a. Magnetos -- CHECK (RPM drop should not exceed 175 RPM on either magneto or 50 RPM differential between magnetos).
 - b. Propeller -- CYCLE from high to low RPM; return to high RPM (full in).
 - c. Carburetor Heat -- CHECK (for RPM drop).
 - d. Engine Instruments and Ammeter -- CHECK.
 - e. Suction Gage -- CHECK.
11. Throttle -- 800-1000 RPM.
12. Radios -- SET.
13. Electric Trim (if installed) -- PREFLIGHT TEST (See Section 9).
14. Autopilot (if installed) -- PREFLIGHT TEST (See Section 9), then OFF.
15. Air Conditioner (if installed) -- OFF.
16. Strobe Lights (if installed) -- AS DESIRED.
17. Throttle Friction Lock -- ADJUST.
18. Parking Brake -- RELEASE.

TAKEOFF

NORMAL TAKEOFF

1. Wing Flaps -- 0° - 20°.
2. Carburetor Heat -- COLD.
3. Power -- FULL THROTTLE and 2400 RPM.
4. Elevator Control -- LIFT NOSE WHEEL at 50 KIAS.

NOTE

When the nose wheel is lifted, the gear motor may run 1-2 seconds to restore hydraulic pressure.

5. Climb Speed -- 70 KIAS (flaps 20°).
80 KIAS (flaps UP).
6. Brakes -- APPLY momentarily when airborne.
7. Landing Gear -- RETRACT in climb out.
8. Wing Flaps -- RETRACT.

SHORT FIELD TAKEOFF

1. Wing Flaps -- 20°.
2. Carburetor Heat -- COLD.
3. Brakes -- APPLY.
4. Power -- FULL THROTTLE and 2400 RPM.
5. Brakes -- RELEASE.
6. Elevator Control -- MAINTAIN SLIGHTLY TAIL-LOW ATTITUDE.
7. Climb Speed -- 59 KIAS until all obstacles are cleared.
8. Landing Gear -- RETRACT after obstacles are cleared.
9. Wing Flaps -- RETRACT slowly after reaching 70 KIAS.

ENROUTE CLIMB

NORMAL CLIMB

1. Airspeed -- 90-100 KIAS.
2. Power -- 23 INCHES Hg and 2400 RPM.
3. Fuel Selector Valve -- BOTH.
4. Mixture -- FULL RICH (mixture may be leaned above 3000 feet).
5. Cowl Flaps -- OPEN as required.

MAXIMUM PERFORMANCE CLIMB

1. Airspeed -- 88 KIAS at sea level to 75 KIAS at 10,000 feet.
2. Power -- FULL THROTTLE and 2400 RPM.
3. Fuel Selector Valve -- BOTH.
4. Mixture -- FULL RICH (mixture may be leaned above 3000 feet).
5. Cowl Flaps -- FULL OPEN.

CRUISE

1. Power -- 15-23 INCHES Hg, 2100-2400 RPM (no more than 75% power).
2. Elevator and Rudder Trim -- ADJUST.
3. Mixture -- LEAN.
4. Cowl Flaps -- CLOSED.

DESCENT

1. Fuel Selector Valve -- BOTH.
2. Power -- AS DESIRED.
3. Carburetor Heat -- AS REQUIRED to prevent carburetor icing.

4. Mixture -- ENRICHEN as required.
5. Cowl Flaps -- CLOSED.
6. Wing Flaps -- AS DESIRED (0° - 10° below 140 KIAS, 10° - 40° below 95 KIAS).

NOTE

The landing gear may be used below 140 KIAS to increase the rate of descent.

BEFORE LANDING

1. Seats, Seat Belts, Shoulder Harnesses -- ADJUST and LOCK.
2. Fuel Selector Valve -- BOTH.
3. Landing Gear -- DOWN (below 140 KIAS).
4. Landing Gear -- CHECK (observe main gear down and green indicator light illuminated).
5. Mixture -- RICH.
6. Carburetor Heat -- ON (apply full heat before closing throttle).
7. Propeller -- HIGH RPM.
8. Autopilot (if installed) -- OFF.
9. Air Conditioner (if installed) -- OFF.

LANDING

NORMAL LANDING

1. Airspeed -- 70-80 KIAS (flaps UP).
2. Wing Flaps -- AS DESIRED (0° - 10° below 140 KIAS, 10°-40° below 95 KIAS).
3. Airspeed -- 65-75 KIAS (flaps DOWN).
4. Trim -- ADJUST.
5. Touchdown -- MAIN WHEELS FIRST.
6. Landing Roll -- LOWER NOSE WHEEL GENTLY.
7. Braking -- MINIMUM REQUIRED.

SHORT FIELD LANDING

1. Airspeed -- 70-80 KIAS (flaps UP).
2. Wing Flaps -- 40° (below 95 KIAS).
3. Airspeed -- MAINTAIN 64 KIAS.
4. Trim -- ADJUST.
5. Power -- REDUCE to idle as obstacle is cleared.
6. Touchdown -- MAIN WHEELS FIRST.
7. Brakes -- APPLY HEAVILY.
8. Wing Flaps -- RETRACT for maximum brake effectiveness.

BALKED LANDING

1. Power -- FULL THROTTLE and 2400 RPM.
2. Carburetor Heat -- COLD.
3. Wing Flaps -- RETRACT to 20°.
4. Climb Speed -- 75 KIAS.
5. Wing Flaps -- RETRACT slowly.
6. Cowl Flaps -- OPEN.

AFTER LANDING

1. Wing Flaps -- UP.
2. Carburetor Heat -- COLD.
3. Cowl Flaps -- OPEN.

SECURING AIRPLANE

1. Parking Brake -- SET.
2. Throttle -- IDLE.
3. Avionics Power Switch, Electrical Equipment -- OFF.
4. Mixture -- IDLE CUT-OFF (pulled full out).
5. Ignition Switch -- OFF.
6. Master Switch -- OFF.
7. Control Lock -- INSTALL.
8. Fuel Selector Valve -- RIGHT.

AMPLIFIED PROCEDURES

STARTING ENGINE

Ordinarily the engine starts easily with one or two pumps of the throttle in warm temperatures with the mixture full rich. If the engine is very hot, up to six pumps of the throttle should be used. In cooler weather, six to eight pumps of the throttle may be necessary. In extremely cold temperatures, it may be necessary to prime while cranking.

NOTE

Additional details concerning cold weather starting and operation may be found under COLD WEATHER OPERATION paragraphs in this section.

Weak intermittent firing followed by puffs of black smoke from the exhaust stack indicates overpriming or flooding. Excess fuel can be cleared from the combustion chambers by the following procedure: Set the mixture control full lean and the throttle full open; then crank the engine through several revolutions with the starter. Repeat the starting procedure without any additional priming.

If the engine is underprimed (most likely in cold weather with a cold engine) it will not fire at all. Additional priming will be necessary for the next starting attempt. As soon as the cylinders begin to fire, open the throttle slightly to keep it running.

If prolonged cranking is necessary, allow the starter motor to cool at frequent intervals, since excessive heat may damage the armature.

After starting, if the oil gage does not begin to show pressure within 30 seconds in the summertime and about twice that long in very cold weather, stop engine and investigate. Lack of oil pressure can cause serious engine damage. After starting, avoid the use of carburetor heat unless icing conditions prevail.

TAXIING

When taxiing, it is important that speed and use of brakes be held to a minimum and that all controls be utilized (see Taxiing Diagram, figure 4-2) to maintain directional control and balance.

The carburetor heat control knob should be pushed full in during all ground operations unless heat is absolutely necessary for smooth engine operation. When the knob is pulled out to the heat position, air entering the engine is not filtered.

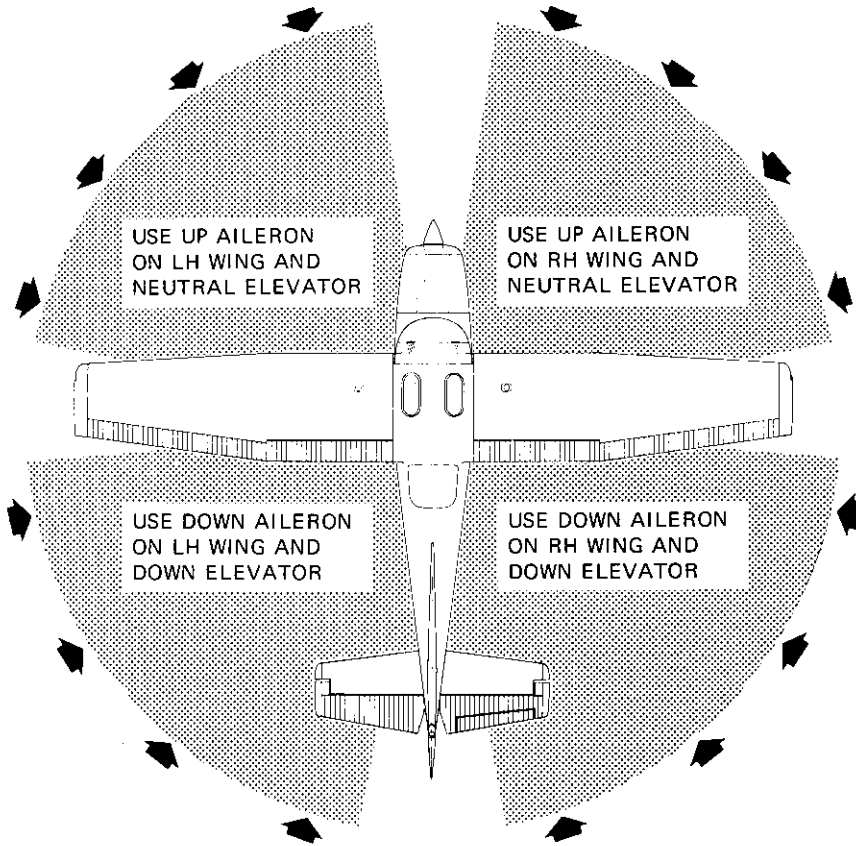

CODE

WIND DIRECTION 

NOTE

Strong quartering tail winds require caution. Avoid sudden bursts of the throttle and sharp braking when the airplane is in this attitude. Use the steerable nose wheel and rudder to maintain direction.

Figure 4-2. Taxiing Diagram

Taxiing over loose gravel or cinders should be done at low engine speed to avoid abrasion and stone damage to the propeller tips.

BEFORE TAKEOFF

WARM-UP

Since the engine is closely cowled for efficient in-flight cooling, precautions should be taken to avoid overheating on the ground. Full power checks on the ground are not recommended unless the pilot has good reason to suspect that the engine is not turning up properly.

MAGNETO CHECK

The magneto check should be made at 1700 RPM as follows. Move ignition switch first to R position and note RPM. Next move switch back to BOTH to clear the other set of plugs. Then move switch to the L position, note RPM and return the switch to the BOTH position. RPM drop should not exceed 175 RPM on either magneto or show greater than 50 RPM differential between magnetos. If there is a doubt concerning operation of the ignition system, RPM checks at higher engine speeds will usually confirm whether a deficiency exists.

An absence of RPM drop may be an indication of faulty grounding of one side of the ignition system or should be cause for suspicion that the magneto timing is set in advance of the setting specified.

ALTERNATOR CHECK

Prior to flights where verification of proper alternator and alternator control unit operation is essential (such as night or instrument flights), a positive verification can be made by loading the electrical system momentarily (3 to 5 seconds) with the landing lights during the engine runup (1700 RPM). The ammeter will remain within a needle width of the initial reading if the alternator and alternator control unit are operating properly.

TAKEOFF

POWER CHECK

It is important to check takeoff power early in the takeoff run. Any sign of rough engine operation or sluggish engine acceleration is good cause for discontinuing the takeoff.

Full power runups over loose gravel are especially harmful to propeller tips. When takeoffs must be made over a gravel surface, it is very important that the throttle be advanced slowly. This allows the airplane to start rolling before high RPM is developed, and the gravel will be blown back of the propeller rather than pulled into it. When unavoidable small dents appear in the propeller blades they should be corrected immediately as described in Section 8 under Propeller Care.

After full power is applied, adjust the throttle friction lock clockwise to prevent the throttle from creeping from a maximum power position. Similar friction lock adjustment should be made as required in other flight conditions to maintain a fixed throttle setting.

WING FLAP SETTINGS

Normal takeoffs are accomplished with wing flaps 0° to 20°. Using 20° wing flaps reduces the ground run and total distance over an obstacle by approximately 20 per cent. Flap deflections greater than 20° are not approved for takeoff.

If 20° wing flaps are used for takeoff, they should be left down until all obstacles are cleared and a safe flap retraction speed of 70 KIAS is reached. To clear an obstacle with wing flaps 20°, an obstacle clearance speed of 59 KIAS should be used.

Soft field takeoffs are performed with 20° flaps by lifting the airplane off the ground as soon as practical in a slightly tail-low attitude. If no obstacles are ahead, the airplane should be leveled off immediately to accelerate to a safer climb speed.

With wing flaps retracted and no obstacles ahead, a climb-out speed of 80 KIAS would be most efficient.

CROSSWIND TAKEOFF

Takeoffs into strong crosswinds normally are performed with the minimum flap setting necessary for the field length, to minimize the drift angle immediately after takeoff. With the ailerons partially deflected into the wind, the airplane is accelerated to a speed slightly higher than normal, and then pulled off abruptly to prevent possible settling back to the runway while drifting. When clear of the ground, make a coordinated turn into the wind to correct for drift.

LANDING GEAR RETRACTION

Landing gear retraction normally is started after reaching the point over the runway where a wheels-down, forced landing on that runway

would become impractical. Since the landing gear swings downward approximately two feet as it starts the retraction cycle, damage can result by retracting it before obtaining at least that much ground clearance.

Before retracting the landing gear, the brakes should be applied momentarily to stop wheel rotation. Centrifugal force caused by the rapidly-spinning wheel expands the diameter of the tire. If there is an accumulation of mud or ice in the wheel wells, the rotating wheel may rub as it is retracted into the wheel well.

ENROUTE CLIMB

Normal climbs are performed at 90-100 KIAS with flaps up, 23 In. Hg. or full throttle (whichever is less) and 2400 RPM for the best combination of engine cooling, rate of climb and forward visibility. If it is necessary to climb rapidly to clear mountains or reach favorable winds at high altitudes, the best rate-of-climb speed should be used with maximum power. This speed is 88 KIAS at sea level, decreasing to 75 KIAS at 10,000 feet.

If an obstruction ahead requires a steep climb angle, a best angle-of-climb speed should be used with landing gear and flaps up and maximum power. This speed is 65 KIAS at sea level, increasing to 67 KIAS at 10,000 feet.

The mixture should be full rich during climb at altitudes up to 3000 feet. Above 3000 feet, a full rich mixture setting may be used or the mixture may be leaned for increased power. Also, the mixture may be leaned as required for smooth engine operation. With the Cessna Economy Mixture Indicator, the mixture may be leaned to maintain the EGT indication corresponding to full rich at 3000 feet. This procedure will significantly improve high altitude climb performance.

CRUISE

Normal cruising is performed between 55% and 75% power. The corresponding power settings and fuel consumption for various altitudes can be determined by using your Cessna Power Computer or the data in Section 5.

NOTE

Cruising should be done at a minimum of 75% power until a total of 25 hours has accumulated or oil consumption has stabilized. Operation at this higher power will ensure

proper seating of the rings and is applicable to new engines, and engines in service following cylinder replacement or top overhaul of one or more cylinders.

The Cruise Performance Table, figure 4-3, illustrates the true airspeed and nautical miles per gallon during cruise for various altitudes and percent powers. This table should be used as a guide, along with the available winds aloft information, to determine the most favorable altitudes and power setting for a given trip. The selection of cruise altitude on the basis of the most favorable wind conditions and the use of low power settings are significant factors that should be considered on every trip to reduce fuel consumption.

For reduced noise levels, it is desirable to select the lowest RPM in the green arc range for a given percent power that will provide smooth engine operation. The cowl flaps should be opened, if necessary, to maintain the cylinder head temperature at approximately two-thirds of the normal operating range (green arc).

Cruise performance data in this handbook and on the power computer is based on a recommended lean mixture setting which may be established as follows:

1. Lean the mixture until the engine becomes rough.
2. Enrichen the mixture to obtain smooth engine operation; then further enrichen an equal amount.

For best fuel economy at 75% power or less, the engine may be operated at the leanest mixture that results in smooth engine operation. This will result in approximately 6% greater range than shown in this handbook accompanied by approximately 3 knots decrease in speed.

ALTITUDE	75% POWER		65% POWER		55% POWER	
	KTAS	NMPG	KTAS	NMPG	KTAS	NMPG
2500	148	11.0	140	11.9	131	13.0
5000	152	11.2	143	12.2	134	13.3
7500	156	11.5	147	12.5	136	13.5
10,000	---	---	150	12.8	139	13.8
Standard Conditions					Zero Wind	

Figure 4-3. Cruise Performance Table

Any change in altitude, power or carburetor heat will require a change in the recommended lean mixture setting and a recheck of the EGT setting (if installed).

Carburetor ice, as evidenced by an unexplained drop in manifold pressure, can be removed by application of full carburetor heat. Upon regaining the original manifold pressure indication (with heat off), use the minimum amount of heat (by trial and error) to prevent ice from forming. Since the heated air causes a richer mixture, readjust the mixture setting when carburetor heat is to be used continuously in cruise flight.

LEANING WITH A CESSNA ECONOMY MIXTURE INDICATOR (EGT)

Exhaust gas temperature (EGT) as shown on the Cessna Economy Mixture Indicator may be used as an aid for mixture leaning in cruising flight at 75% power or less. To adjust the mixture, using this indicator, lean to establish the peak EGT as a reference point and then enrichen the mixture by a desired increment based on data in figure 4-4.

As noted in the table, operation at peak EGT provides best fuel economy. This results in approximately 6% greater range than shown in this handbook accompanied by approximately 3 knots decrease in speed.

When leaning the mixture under some conditions, engine roughness may occur before peak EGT is reached. In this case, use the EGT corresponding to the onset of roughness as the reference point instead of peak EGT.

MIXTURE DESCRIPTION	EXHAUST GAS TEMPERATURE
RECOMMENDED LEAN (Pilot's Operating Handbook and Power Computer)	50°F Rich of Peak EGT
BEST ECONOMY	Peak EGT

Figure 4-4. EGT Table

STALLS

The stall characteristics are conventional and aural warning is provided by a stall warning horn which sounds between 5 and 10 knots above the stall in all configurations.

Power-off stall speeds at maximum weight for both forward and aft C.G. positions are presented in Section 5.

BEFORE LANDING

In view of the relatively low drag of the extended landing gear and the high allowable gear operating speed (140 KIAS), the landing gear should be extended before entering the traffic pattern. This practice will allow more time to confirm that the landing gear is down and locked. As a further precaution, leave the landing gear extended in go-around procedures or traffic patterns for touch-and-go landings.

Landing gear extension can be detected by illumination of the gear down indicator light (green), absence of a gear warning horn with the throttle retarded below 12 inches of manifold pressure and/or the wing flaps extended beyond 25°, and visual inspection of the main gear position. Should the gear indicator light fail to illuminate, the light should be checked for a burned-out bulb by pushing to test. A burned-out bulb can be replaced in flight with the landing gear up (amber) indicator light.

LANDING

NORMAL LANDING

Landings should be made on the main wheels first to reduce the landing speed and the subsequent need for braking in the landing roll. The nose wheel is lowered gently to the runway after the speed has diminished to avoid unnecessary nose gear load. This procedure is especially important in rough field landings.

SHORT FIELD LANDING

For a short field landing, make a power-off approach at 64 KIAS with 40° flaps and land on the main wheels first. Immediately after touchdown, lower the nose gear to the ground and apply heavy braking as required. For maximum brake effectiveness after all three wheels are on the ground, retract the flaps, hold full nose up elevator and apply maximum possible brake pressure without sliding the tires.

CROSSWIND LANDING

When landing in a strong crosswind, use the minimum flap setting required for the field length. Although the crab or combination method of drift correction may be used, the wing-low method gives the best control. After touchdown, hold a straight course with the steerable nose wheel and occasional braking if necessary.

BALKED LANDING

In a balked landing (go-around) climb, the wing flap setting should be reduced to 20° immediately after full power is applied. After all obstacles are cleared and a safe altitude and airspeed are obtained, the wing flaps should be retracted.

COLD WEATHER OPERATION

STARTING

Prior to starting on cold mornings, it is advisable to pull the propeller through several times by hand to "break loose" or "limber" the oil, thus conserving battery energy.

NOTE

When pulling the propeller through by hand, treat it as if the ignition switch is turned on. A loose or broken ground wire on either magneto could cause the engine to fire.

In extremely cold (-18°C and lower) weather, the use of an external preheater and an external power source are recommended whenever possible to obtain positive starting and to reduce wear and abuse to the engine and the electrical system. Pre-heat will thaw the oil trapped in the oil cooler, which probably will be congealed prior to starting in extremely cold temperatures. When using an external power source, the position of the master switch is important. Refer to Section 9, Supplements, for Ground Service Plug Receptacle operating details.

Cold weather starting procedures are as follows:

With Preheat:

1. With ignition switch turned off, mixture full rich and throttle open 1/2 inch, prime the engine four to eight strokes.

NOTE

Use heavy strokes of the primer for best atomization of fuel. After priming, push primer all the way in and turn to the locked position to avoid the possibility of the engine drawing fuel through the primer.

2. Propeller -- CLEAR.
3. Avionics Power Switch -- OFF.
4. Master Switch -- ON.
5. Throttle -- PUMP several times.
6. Ignition Switch -- START (release to BOTH when engine starts).

Without Preheat:

1. Prime the engine five to six strokes with mixture full rich and throttle open 1/2 inch. Leave the primer charged and ready for a stroke.
2. Propeller -- CLEAR.
3. Avionics Power Switch -- OFF.
4. Master Switch -- ON.
5. Pump throttle rapidly to full open four times. Return to 1/2 inch open position.
6. Ignition Switch -- START.
7. Release ignition switch to BOTH when engine starts.
8. Continue to prime engine until it is running smoothly, or alternately, pump the throttle rapidly over first 1/4 of total travel.
9. Oil Pressure -- CHECK.
10. Primer -- LOCK.

NOTE

If the engine does not start during the first few attempts, or if engine firing diminishes in strength, it is probable that the spark plugs have been frosted over. Preheat must be used before another start is attempted.

CAUTION

Excessive pumping of the throttle may cause raw fuel to accumulate in the intake manifold, creating a fire hazard in the event of a backfire. If this occurs, maintain a cranking action to suck flames into the engine. An outside attendant with a fire extinguisher is advised for cold starts without preheat.

OPERATION

During cold weather operations, no indication will be apparent on the oil temperature gage prior to takeoff if outside air temperatures are very cold. After a suitable warm-up period (2 to 5 minutes at 1000 RPM), accelerate the engine several times to higher engine RPM. If the engine accelerates smoothly and the oil pressure remains normal and steady, the airplane is ready for takeoff.

Rough engine operation in cold weather can be caused by a combination of an inherently leaner mixture due to the dense air and poor vaporization and distribution of the fuel-air mixture to the cylinders. The effects of these conditions are especially noticeable during operation on one magneto in ground checks where only one spark plug fires in each cylinder.

For optimum operation of the engine in cold weather, the appropriate use of carburetor heat may be necessary. The following procedures are indicated as a guideline:

1. Use the minimum carburetor heat required for smooth operation in takeoff, climb, and cruise.

NOTE

Care should be exercised when using partial carburetor heat to avoid icing. Partial heat may raise the carburetor air temperature to 0° to 21°C range where icing is critical under certain atmospheric conditions.

2. If the airplane is equipped with a carburetor air temperature gage, it can be used as a reference in maintaining carburetor air temperature at or slightly above the top of the yellow arc by application of carburetor heat.

HOT WEATHER OPERATION

The general warm temperature starting information in this section is appropriate. Avoid prolonged engine operation on the ground.

NOISE CHARACTERISTICS

Increased emphasis on improving the quality of our environment requires renewed effort on the part of all pilots to minimize the effect of airplane noise on the public.

We, as pilots, can demonstrate our concern for environmental improvement, by application of the following suggested procedures, and thereby tend to build public support for aviation:

1. Pilots operating aircraft under VFR over outdoor assemblies of persons, recreational and park areas, and other noise-sensitive areas should make every effort to fly not less than 2000 feet above the surface, weather permitting, even though flight at a lower level may be consistent with the provisions of government regulations.
2. During departure from or approach to an airport, climb after takeoff and descent for landing should be made so as to avoid prolonged flight at low altitude near noise-sensitive areas.

NOTE

The above recommended procedures do not apply where they would conflict with Air Traffic Control clearances or instructions, or where, in the pilot's judgment, an altitude of less than 2000 feet is necessary for him to adequately exercise his duty to see and avoid other aircraft.

The certificated noise level for the Model R182 at 3100 pounds maximum weight is 70.7 dB(A) with a two-bladed propeller and 68.3 dB(A) with a three-bladed propeller. No determination has been made by the Federal Aviation Administration that the noise levels of this airplane are or should be acceptable or unacceptable for operation at, into, or out of, any airport.

SECTION 5 PERFORMANCE

TABLE OF CONTENTS

	Page
Introduction	5-3
Use of Performance Charts	5-3
Sample Problem	5-3
Takeoff	5-4
Cruise	5-5
Fuel Required	5-5
Landing	5-7
Demonstrated Operating Temperature	5-7
Figure 5-1, Airspeed Calibration - Normal Static Source	5-8
Airspeed Calibration - Alternate Static Source	5-9
Figure 5-2, Temperature Conversion Chart	5-10
Figure 5-3, Stall Speeds	5-11
Figure 5-4, Takeoff Distance - 3100 Lbs	5-12
Takeoff Distance - 2800 Lbs And 2500 Lbs	5-13
Figure 5-5, Maximum Rate Of Climb	5-14
Figure 5-6, Time, Fuel, And Distance To Climb - Maximum Rate Of Climb	5-15
Time, Fuel, And Distance To Climb - Normal Climb	5-16
Figure 5-7, Cruise Performance - 2000 Feet	5-17
Cruise Performance - 4000 Feet	5-18
Cruise Performance - 6000 Feet	5-19
Cruise Performance - 8000 Feet	5-20
Cruise Performance - 10,000 Feet	5-21
Cruise Performance - 12,000 Feet	5-22
Cruise Performance - 14,000 Feet	5-23
Figure 5-8, Range Profile - 65 Gallons Fuel	5-24
Range Profile - 88 Gallons Fuel	5-25
Figure 5-9, Endurance Profile - 65 Gallons Fuel	5-26
Endurance Profile - 88 Gallons Fuel	5-27
Figure 5-10, Landing Distance	5-28

INTRODUCTION

Performance data charts on the following pages are presented so that you may know what to expect from the airplane under various conditions, and also, to facilitate the planning of flights in detail and with reasonable accuracy. The data in the charts has been computed from actual flight tests with the airplane and engine in good condition and using average piloting techniques.

It should be noted that the performance information presented in the range and endurance profile charts allows for 45 minutes reserve fuel at the specified cruise power. Fuel flow data for cruise is based on the recommended lean mixture setting. Some indeterminate variables such as mixture leaning technique, fuel metering characteristics, engine and propeller condition, and air turbulence may account for variations of 10% or more in range and endurance. Therefore, it is important to utilize all available information to estimate the fuel required for the particular flight.

USE OF PERFORMANCE CHARTS

Performance data is presented in tabular or graphical form to illustrate the effect of different variables. Sufficiently detailed information is provided in the tables so that conservative values can be selected and used to determine the particular performance figure with reasonable accuracy.

SAMPLE PROBLEM

The following sample flight problem utilizes information from the various charts to determine the predicted performance data for a typical flight. The following information is known:

AIRPLANE CONFIGURATION

Takeoff weight	3050 Pounds
Usable fuel	65 Gallons

TAKEOFF CONDITIONS

Field pressure altitude	1500 Feet
Temperature	28°C (16°C above standard)
Wind component along runway	12 Knot Headwind
Field length	3500 Feet

CRUISE CONDITIONS

Total distance	520 Nautical Miles
Pressure altitude	7500 Feet
Temperature	16°C (16°C above standard)
Expected wind enroute	10 Knot Headwind

LANDING CONDITIONS

Field pressure altitude	2000 Feet
Temperature	25°C
Field length	3000 Feet

TAKEOFF

The takeoff distance chart, figure 5-4, should be consulted, keeping in mind that the distances shown are based on the short field technique. Conservative distances can be established by reading the chart at the next higher value of weight, altitude and temperature. For example, in this particular sample problem, the takeoff distance information presented for a weight of 3100 pounds, pressure altitude of 2000 feet and a temperature of 30°C should be used and results in the following:

Ground roll	1085 Feet
Total distance to clear a 50-foot obstacle	2110 Feet

These distances are well within the available takeoff field length. However, a correction for the effect of wind may be made based on Note 3 of the takeoff chart. The correction for a 12 knot headwind is:

$$\frac{12 \text{ Knots}}{9 \text{ Knots}} \times 10\% = 13\% \text{ Decrease}$$

This results in the following distances, corrected for wind:

Ground roll, zero wind	1085
Decrease in ground roll (1085 feet × 13%)	<u>141</u>
Corrected ground roll	944 Feet
Total distance to clear a 50-foot obstacle, zero wind	2110
Decrease in total distance (2110 feet × 13%)	<u>274</u>
Corrected total distance to clear a 50-foot obstacle	1836 Feet

CRUISE

The cruising altitude should be selected based on a consideration of trip length, winds aloft, and the airplane's performance. A cruising altitude and the expected wind enroute have been given for this sample problem. However, the power setting selection for cruise must be determined based on several considerations. These include the cruise performance characteristics presented in figure 5-7, the range profile chart presented in figure 5-8, and the endurance profile chart presented in figure 5-9.

The relationship between power and range is illustrated by the range profile chart. Considerable fuel savings and longer range result when lower power settings are used. For this sample problem, a cruise power of approximately 65% will be used.

The cruise performance chart for 8000 feet pressure altitude is entered using 20°C above standard temperature. These values most nearly correspond to the planned altitude and expected temperature conditions. The power setting chosen is 2200 RPM and 21 inches of manifold pressure, which results in the following:

Power	65%
True airspeed	150 Knots
Cruise fuel flow	11.7 GPH

The power computer may be used to determine power and fuel consumption more accurately during the flight.

FUEL REQUIRED

The total fuel requirement for the flight may be estimated using the performance information in figures 5-6 and 5-7. For this sample problem, figure 5-6 shows that a normal climb from 2000 feet to 8000 feet requires 3.4 gallons of fuel. The corresponding distance during the climb is 16 nautical miles. These values are for a standard temperature and are sufficiently accurate for most flight planning purposes. However, a further correction for the effect of temperature may be made as noted on the climb chart. The approximate effect of a non-standard temperature is to increase the time, fuel, and distance by 10% for each 10°C above standard temperature, due to the lower rate of climb. In this case, assuming a temperature 16°C above standard, the correction would be:

$$\frac{16^{\circ}\text{C}}{10^{\circ}\text{C}} \times 10\% = 16\% \text{ Increase}$$

With this factor included, the fuel estimate would be calculated as follows:

Fuel to climb, standard temperature	3.4
Increase due to non-standard temperature (3.4 × 16%)	<u>0.5</u>
Corrected fuel to climb	3.9 Gallons

Using a similar procedure for the distance during climb results in 19 nautical miles.

The resultant cruise distance is:

Total distance	520
Climb distance	<u>-19</u>
Cruise distance	501 Nautical Miles

With an expected 10 knot headwind, the ground speed for cruise is predicted to be:

$$\begin{array}{r} 150 \\ -10 \\ \hline 140 \text{ Knots} \end{array}$$

Therefore, the time required for the cruise portion of the trip is:

$$\frac{501 \text{ Nautical Miles}}{140 \text{ Knots}} = 3.6 \text{ Hours}$$

The fuel required for cruise is:

$$3.6 \text{ hours} \times 11.7 \text{ gallons/hour} = 42.1 \text{ Gallons}$$

A 45-minute reserve requires:

$$\frac{45}{60} \times 11.7 \text{ gallons/hour} = 8.8 \text{ Gallons}$$

The total estimated fuel required is as follows:

Engine start, taxi, and takeoff	2.0
Climb	3.9
Cruise	42.1
Reserve	<u>8.8</u>
Total fuel required	56.8 Gallons

Once the flight is underway, ground speed checks will provide a more accurate basis for estimating the time enroute and the corresponding fuel required to complete the trip with ample reserve.

LANDING

A procedure similar to takeoff should be used for estimating the landing distance at the destination airport. Figure 5-10 presents landing distance information for the short field technique. The distances corresponding to 2000 feet pressure altitude and a temperature of 30°C are as follows:

Ground roll	680 Feet
Total distance to clear a 50-foot obstacle	1450 Feet

A correction for the effect of wind may be made based on Note 2 of the landing chart using the same procedure as outlined for takeoff.

DEMONSTRATED OPERATING TEMPERATURE

Satisfactory engine cooling has been demonstrated for this airplane with an outside air temperature 23°C above standard. This is not to be considered as an operating limitation. Reference should be made to Section 2 for engine operating limitations.

AIRSPEED CALIBRATION

NORMAL STATIC SOURCE

CONDITIONS:

Power required for level flight or maximum power during descent.

FLAPS UP														
KIAS	50	60	70	80	90	100	110	120	130	140	150	160	170	
KCAS	61	65	72	81	90	100	109	118	128	137	146	156	165	
FLAPS 20°														
KIAS	40	50	60	70	80	90	95	---	---	---	---	---	---	
KCAS	47	55	64	72	81	90	95	---	---	---	---	---	---	
FLAPS 40°														
KIAS	40	50	60	70	80	90	95	---	---	---	---	---	---	
KCAS	50	55	63	72	81	91	96	---	---	---	---	---	---	

Figure 5-1. Airspeed Calibration (Sheet 1 of 2)

AIRSPEED CALIBRATION ALTERNATE STATIC SOURCE

HEATER/VENTS AND WINDOWS CLOSED

FLAPS UP												
NORMAL KIAS	60	70	80	90	100	110	120	130	140	150	160	
ALTERNATE KIAS	59	70	80	91	101	111	121	130	140	150	160	
FLAPS 20°												
NORMAL KIAS	50	60	70	80	90	95	---	---	---	---	---	---
ALTERNATE KIAS	47	59	70	80	90	94	---	---	---	---	---	---
FLAPS 40°												
NORMAL KIAS	40	50	60	70	80	90	95	---	---	---	---	---
ALTERNATE KIAS	36	48	59	70	74	89	94	---	---	---	---	---

HEATER/VENTS OPEN AND WINDOWS CLOSED

FLAPS UP												
NORMAL KIAS	60	70	80	90	100	110	120	130	140	150	160	
ALTERNATE KIAS	58	68	79	89	99	109	119	129	139	149	158	
FLAPS 20°												
NORMAL KIAS	50	60	70	80	90	95	---	---	---	---	---	---
ALTERNATE KIAS	47	58	69	79	89	94	---	---	---	---	---	---
FLAPS 40°												
NORMAL KIAS	40	50	60	70	80	90	95	---	---	---	---	---
ALTERNATE KIAS	35	47	58	68	78	88	92	---	---	---	---	---

Figure 5-1. Airspeed Calibration (Sheet 2 of 2)

TEMPERATURE CONVERSION CHART

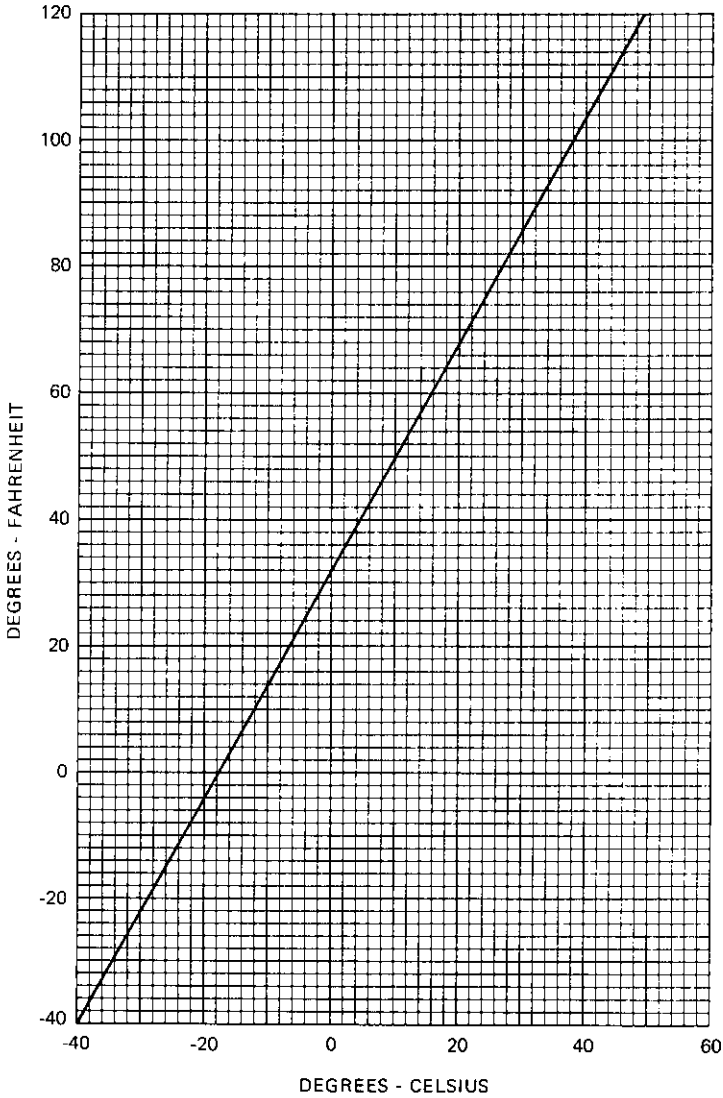

Figure 5-2. Temperature Conversion Chart

STALL SPEEDS

CONDITIONS:
Power Off
Gear Up or Down

NOTES:

1. Maximum altitude loss during a stall recovery may be as much as 240 feet.
2. KIAS values are approximate.

MOST REARWARD CENTER OF GRAVITY

WEIGHT LBS	FLAP DEFLECTION	ANGLE OF BANK							
		0°		30°		45°		60°	
		KIAS	KCAS	KIAS	KCAS	KIAS	KCAS	KIAS	KCAS
3100	UP	39	54	42	58	46	64	55	76
	20°	28	51	30	55	33	61	40	72
	40°	34	50	37	54	40	59	48	71

MOST FORWARD CENTER OF GRAVITY

WEIGHT LBS	FLAP DEFLECTION	ANGLE OF BANK							
		0°		30°		45°		60°	
		KIAS	KCAS	KIAS	KCAS	KIAS	KCAS	KIAS	KCAS
3100	UP	41	55	44	59	49	65	58	78
	20°	30	52	32	56	36	62	42	74
	40°	39	52	42	56	46	62	55	74

Figure 5-3. Stall Speeds

STALL SPEEDS

CONDITIONS:

Power Off

Gear Up or Down

NOTES:

1. Maximum altitude loss during a stall recovery may be as much as 240 feet.
2. KIAS values are approximate.

MOST REARWARD CENTER OF GRAVITY

WEIGHT LBS	FLAP DEFLECTION	ANGLE OF BANK							
		0°		30°		45°		60°	
		KIAS	KCAS	KIAS	KCAS	KIAS	KCAS	KIAS	KCAS
3100	UP	38	54	41	58	45	64	54	76
	20°	28	51	30	55	33	61	40	72
	40°	24	50	26	54	29	59	34	71

MOST FORWARD CENTER OF GRAVITY

WEIGHT LBS	FLAP DEFLECTION	ANGLE OF BANK							
		0°		30°		45°		60°	
		KIAS	KCAS	KIAS	KCAS	KIAS	KCAS	KIAS	KCAS
3100	UP	40	55	43	59	48	65	57	78
	20°	30	52	32	56	36	62	42	74
	40°	30	52	32	56	36	62	42	74

Figure 5-3. Stall Speeds

TAKEOFF DISTANCE
MAXIMUM WEIGHT 3100 LBS

SHORT FIELD

CONDITIONS:
Flaps 20°
2400 RPM and Full Throttle Prior to Brake Release
Cowl Flaps Open
Paved, Level, Dry Runway
Zero Wind

NOTES:

1. Short field technique as specified in Section 4.
2. Prior to takeoff from fields above 3000 feet elevation, the mixture should be leaned to give maximum power in a full throttle, static runup.
3. Decrease distances 10% for each 9 knots headwind. For operation with tailwinds up to 10 knots, increase distances by 10% for each 2 knots.
4. Where distance value has been deleted, climb performance after lift-off is less than 150 fpm at takeoff speed.
5. For operation on a dry, grass runway, increase distances by 15% of the "ground roll" figure.

WEIGHT LBS	TAKEOFF SPEED		PRESS ALT FT	0°C			10°C			20°C			30°C			40°C		
	LIFT OFF	AT 50 FT		GRND ROLL	TO CLEAR 50 FT OBS	TOTAL	GRND ROLL	TO CLEAR 50 FT OBS	TOTAL	GRND ROLL	TO CLEAR 50 FT OBS	TOTAL	GRND ROLL	TO CLEAR 50 FT OBS	TOTAL	GRND ROLL	TO CLEAR 50 FT OBS	TOTAL
3100	52	59	S.L.	735	1410	790	1515	850	1625	910	1745	975	1870					
			1000	800	1545	860	1660	925	1785	995	1915	1065	2060					
			2000	875	1690	940	1820	1010	1960	1085	2110	1165	2275					
			3000	955	1860	1030	2010	1105	2165	1190	2340	1275	2525					
			4000	1045	2055	1125	2225	1210	2405	1300	2605	1395	2825					
			5000	1145	2280	1235	2475	1330	2690	1430	2925	1535	3185					
			6000	1255	2550	1355	2775	1460	3030	1570	3310	1685	3635					
			7000	1380	2870	1490	3140	1605	3450	1730	3805							
8000	1520	3260	1640	3600	1770	3990												

Figure 5-4. Takeoff Distance (Sheet 1 of 2)

TAKEOFF DISTANCE
2800 LBS AND 2500 LBS

SHORT FIELD

REFER TO SHEET 1 FOR APPROPRIATE CONDITIONS AND NOTES.

WEIGHT LBS	TAKEOFF SPEED KIAS		PRESS ALT FT	0°C			10°C			20°C			30°C			40°C		
	LIFT OFF	AT 50 FT		GRND TO CLEAR 50 FT OBS		TOTAL TO CLEAR 50 FT OBS	GRND TO CLEAR 50 FT OBS		TOTAL TO CLEAR 50 FT OBS	GRND TO CLEAR 50 FT OBS		TOTAL TO CLEAR 50 FT OBS	GRND TO CLEAR 50 FT OBS		TOTAL TO CLEAR 50 FT OBS	GRND TO CLEAR 50 FT OBS		TOTAL TO CLEAR 50 FT OBS
				ROLL	ROLL		ROLL	ROLL		ROLL	ROLL		ROLL	ROLL		ROLL	ROLL	
2800	49	56	S.L.	580	1115	625	1195	670	1275	720	1365	770	1460	840	1595	840	1595	
			1000	635	1215	680	1300	730	1395	785	1490	840	1595					
			2000	690	1325	745	1420	800	1520	855	1630	915	1750					
			3000	755	1445	810	1555	870	1670	935	1790	1000	1920					
			4000	820	1585	885	1705	950	1835	1020	1975	1095	2125					
			5000	900	1745	970	1880	1040	2025	1120	2185	1200	2355					
			6000	985	1925	1060	2080	1140	2250	1225	2430	1315	2630					
			7000	1080	2140	1165	2315	1255	2510	1350	2725	1450	2960					
8000	1185	2385	1280	2595	1380	2825	1485	3080	1595	3365								
2500	47	53	S.L.	450	870	485	925	520	990	555	1055	595	1125	645	1220	645	1220	
			1000	490	940	525	1005	565	1075	605	1145	645	1220					
			2000	530	1020	570	1090	615	1165	660	1245	705	1330					
			3000	580	1110	625	1190	670	1270	720	1360	770	1455					
			4000	630	1210	680	1300	730	1390	785	1490	840	1590					
			5000	690	1325	745	1420	800	1525	855	1635	915	1760					
			6000	755	1450	810	1560	875	1675	935	1800	1005	1930					
			7000	825	1595	890	1715	955	1850	1025	1990	1100	2140					
8000	905	1760	975	1900	1050	2050	1130	2210	1210	2385								

Figure 5-4. Takeoff Distance (Sheet 2 of 2)

MAXIMUM RATE OF CLIMB

CONDITIONS:

Flaps Up
Gear Up
2400 RPM
Full Throttle
Mixture Full Rich
Cowl Flaps Open

NOTE:

Mixture may be leaned above 3000 feet for increased power.

WEIGHT LBS	PRESS ALT FT	CLIMB SPEED KIAS	RATE OF CLIMB - FPM			
			-20°C	0°C	20°C	40°C
3100	S.L.	88	1270	1195	1120	1045
	2000	85	1110	1035	960	890
	4000	82	945	875	805	730
	6000	80	785	715	645	570
	8000	77	625	555	485	415
	10,000	75	465	395	325	---
	12,000	72	305	235	165	---
	14,000	69	145	75	---	---

Figure 5-5. Maximum Rate of Climb

TIME, FUEL, AND DISTANCE TO CLIMB

MAXIMUM RATE OF CLIMB

CONDITIONS:

Flaps Up
Gear Up
2400 RPM
Full Throttle
Mixture Full Rich
Cowl Flaps Open
Standard Temperature

NOTES:

1. Add 2.0 gallons of fuel for engine start, taxi and takeoff allowance.
2. Mixture may be leaned above 3000 feet for increased power.
3. Increase time, fuel and distance by 10% for each 10°C above standard temperature.
4. Distances shown are based on zero wind.

WEIGHT LBS	PRESSURE ALTITUDE FT	TEMP °C	CLIMB SPEED KIAS	RATE OF CLIMB FPM	FROM SEA LEVEL		
					TIME MIN	FUEL USED GALLONS	DISTANCE NM
3100	S.L.	15	88	1140	0	0	0
	2000	11	85	995	2	0.8	3
	4000	7	82	850	4	1.6	6
	6000	3	80	705	7	2.6	10
	8000	-1	77	560	10	3.7	15
	10,000	-5	75	415	14	5.1	21
	12,000	-9	72	265	20	7.1	30
	14,000	-13	69	120	32	10.6	47

Figure 5-6. Time, Fuel, and Distance to Climb (Sheet 1 of 2)

TIME, FUEL, AND DISTANCE TO CLIMB

NORMAL CLIMB - 95 KIAS

CONDITIONS:

Flaps Up
Gear Up
2400 RPM
23 Inches Hg or Full Throttle
Mixture Full Rich
Cowl Flaps Open
Standard Temperature

NOTES:

1. Add 2.0 gallons of fuel for engine start, taxi and takeoff allowance.
2. Mixture may be leaned above 3000 feet for increased power.
3. Increase time, fuel and distance by 10% for each 10°C above standard temperature.
4. Distances shown are based on zero wind.

WEIGHT LBS	PRESSURE ALTITUDE FT	TEMP °C	RATE OF CLIMB FPM	FROM SEA LEVEL		
				TIME MIN	FUEL USED GALLONS	DISTANCE NM
3100	S.L.	15	680	0	0	0
	2000	11	680	3	1.0	5
	4000	7	680	6	2.0	10
	6000	3	640	9	3.1	15
	8000	-1	485	12	4.4	21
	10,000	-5	330	18	6.1	30

Figure 5-6. Time, Fuel, and Distance to Climb (Sheet 2 of 2)

CRUISE PERFORMANCE

PRESSURE ALTITUDE 2000 FEET

CONDITIONS:
3100 Pounds
Recommended Lean Mixture
Cowl Flaps Closed

NOTE

For best fuel economy, operate at the leanest mixture that results in smooth engine operation or at peak EGT if an EGT indicator is installed.

		20°C BELOW STANDARD TEMP -9°C			STANDARD TEMPERATURE 11°C			20°C ABOVE STANDARD TEMP 31°C		
RPM	MP	% BHP	KTAS	GPH	% BHP	KTAS	GPH	% BHP	KTAS	GPH
2400	23	---	---	---	76	148	13.6	73	149	13.2
	22	74	143	13.3	71	145	12.8	69	146	12.4
	21	69	140	12.4	67	141	12.0	64	142	11.6
	20	64	136	11.6	62	137	11.3	60	138	10.9
2300	23	75	145	13.5	72	146	13.1	70	147	12.6
	22	71	141	12.7	68	142	12.3	66	143	11.9
	21	66	137	11.9	64	138	11.5	62	139	11.2
	20	61	134	11.2	59	135	10.8	57	135	10.5
2200	23	72	142	12.9	69	143	12.5	67	144	12.1
	22	67	139	12.1	65	140	11.7	63	141	11.4
	21	63	135	11.4	61	136	11.0	59	137	10.7
	20	59	131	10.7	57	132	10.3	55	133	10.0
2100	23	68	139	12.2	66	140	11.8	63	141	11.5
	22	64	136	11.5	62	137	11.2	60	137	10.8
	21	60	132	10.9	58	133	10.5	56	134	10.2
	20	55	128	10.1	54	129	9.8	52	129	9.5
	19	51	124	9.4	50	124	9.1	48	125	8.9
	18	47	119	8.7	45	119	8.5	44	120	8.2

Figure 5-7. Cruise Performance (Sheet 1 of 7)

CRUISE PERFORMANCE

PRESSURE ALTITUDE 4000 FEET

CONDITIONS:
3100 Pounds
Recommended Lean Mixture
Cowl Flaps Closed

NOTE

For best fuel economy, operate at the leanest mixture that results in smooth engine operation or at peak EGT if an EGT indicator is installed.

		20°C BELOW STANDARD TEMP -13°C			STANDARD TEMPERATURE 7°C			20°C ABOVE STANDARD TEMP 27°C		
RPM	MP	% BHP	KTAS	GPH	% BHP	KTAS	GPH	% BHP	KTAS	GPH
2400	23	---	---	---	78	153	14.0	75	154	13.6
	22	76	148	13.7	73	149	13.2	71	150	12.8
	21	71	144	12.8	69	145	12.4	66	146	12.0
	20	66	140	12.0	64	141	11.6	62	142	11.2
2300	23	77	149	14.0	75	150	13.5	72	151	13.0
	22	73	145	13.1	70	147	12.7	68	148	12.2
	21	68	142	12.3	66	143	11.9	64	144	11.5
	20	64	138	11.5	61	139	11.1	59	140	10.8
2200	23	74	146	13.3	71	148	12.9	69	149	12.4
	22	70	143	12.5	67	144	12.1	65	145	11.7
	21	65	139	11.8	63	140	11.4	61	141	11.0
	20	61	135	11.0	59	136	10.7	57	137	10.3
2100	23	70	143	12.7	68	145	12.2	65	146	11.8
	22	66	140	11.9	64	141	11.5	62	142	11.2
	21	62	136	11.2	60	137	10.9	58	138	10.5
	20	58	132	10.5	55	133	10.1	54	134	9.8
	19	53	128	9.8	51	129	9.5	50	129	9.2
	18	49	123	9.1	47	124	8.8	46	124	8.5

Figure 5-7. Cruise Performance (Sheet 2 of 7)

CRUISE PERFORMANCE

PRESSURE ALTITUDE 6000 FEET

CONDITIONS:
3100 Pounds
Recommended Lean Mixture
Cowl Flaps Closed

NOTE

For best fuel economy, operate at the leanest mixture that results in smooth engine operation or at peak EGT if an EGT indicator is installed.

		20°C BELOW STANDARD TEMP -17°C			STANDARD TEMPERATURE 3°C			20°C ABOVE STANDARD TEMP 23°C		
RPM	MP	% BHP	KTAS	GPH	% BHP	KTAS	GPH	% BHP	KTAS	GPH
2400	22	---	---	---	75	154	13.6	73	155	13.1
	21	73	148	13.2	71	150	12.7	68	151	12.3
	20	69	145	12.3	66	146	11.9	64	147	11.5
	19	64	140	11.5	61	141	11.1	59	142	10.8
2300	23	---	---	---	77	155	13.9	74	156	13.4
	22	75	150	13.5	72	151	13.0	70	152	12.6
	21	70	146	12.7	68	147	12.2	66	148	11.8
	20	66	142	11.9	63	143	11.5	61	144	11.1
2200	23	76	151	13.7	74	152	13.3	71	153	12.8
	22	72	147	12.9	69	148	12.5	67	150	12.1
	21	67	144	12.1	65	145	11.7	63	146	11.4
	20	63	140	11.4	61	141	11.0	59	141	10.7
2100	23	72	148	13.1	70	149	12.6	68	150	12.2
	22	68	144	12.3	66	145	11.9	64	146	11.5
	21	64	141	11.6	62	142	11.2	60	142	10.8
	20	60	137	10.9	57	137	10.5	56	138	10.2
	19	55	132	10.1	53	133	9.8	52	133	9.5
	18	51	128	9.4	49	128	9.1	48	128	8.8

Figure 5-7. Cruise Performance (Sheet 3 of 7)

CRUISE PERFORMANCE

PRESSURE ALTITUDE 8000 FEET

CONDITIONS:
3100 Pounds
Recommended Lean Mixture
Cowl Flaps Closed

NOTE

For best fuel economy, operate at the leanest mixture that results in smooth engine operation or at peak EGT if an EGT indicator is installed.

		20°C BELOW STANDARD TEMP -21°C			STANDARD TEMPERATURE -1°C			20°C ABOVE STANDARD TEMP 19°C		
RPM	MP	% BHP	KTAS	GPH	% BHP	KTAS	GPH	% BHP	KTAS	GPH
2400	21	76	153	13.6	73	154	13.1	70	155	12.7
	20	71	149	12.7	68	150	12.3	66	151	11.9
	19	66	145	11.9	63	146	11.5	61	147	11.1
	18	61	140	11.1	59	141	10.7	57	142	10.3
2300	21	73	151	13.1	70	152	12.6	68	153	12.2
	20	68	147	12.2	65	148	11.8	63	149	11.4
	19	63	142	11.4	61	143	11.1	59	144	10.7
	18	58	138	10.6	56	138	10.3	54	139	9.9
2200	21	70	148	12.5	67	149	12.1	65	150	11.7
	20	65	144	11.7	63	145	11.3	60	146	11.0
	19	60	140	11.0	58	141	10.6	56	141	10.3
	18	56	135	10.2	54	136	9.9	52	136	9.5
2100	21	66	145	11.9	64	146	11.5	61	147	11.2
	20	62	141	11.2	59	142	10.8	57	142	10.5
	19	57	137	10.5	55	137	10.1	53	138	9.8
	18	53	132	9.7	51	132	9.4	49	133	9.1
	17	49	127	9.0	47	127	8.7	45	127	8.4

Figure 5-7. Cruise Performance (Sheet 4 of 7)

CRUISE PERFORMANCE

PRESSURE ALTITUDE 10,000 FEET

CONDITIONS:
3100 Pounds
Recommended Lean Mixture
Cowl Flaps Closed

NOTE

For best fuel economy, operate at the leanest mixture that results in smooth engine operation or at peak EGT if an EGT indicator is installed.

		20°C BELOW STANDARD TEMP -25°C			STANDARD TEMPERATURE -5°C			20°C ABOVE STANDARD TEMP 15°C		
RPM	MP	% BHP	KTAS	GPH	% BHP	KTAS	GPH	% BHP	KTAS	GPH
2400	20	73	154	13.1	70	155	12.6	68	156	12.2
	19	68	149	12.2	65	150	11.8	63	151	11.4
	18	63	145	11.4	60	145	11.0	58	146	10.6
	17	58	140	10.6	56	140	10.2	54	141	9.9
2300	20	70	151	12.6	67	152	12.2	65	153	11.8
	19	65	147	11.8	63	148	11.4	61	149	11.0
	18	60	142	11.0	58	143	10.6	56	143	10.3
	17	56	137	10.2	53	138	9.8	52	138	9.5
2200	20	67	149	12.1	65	150	11.7	62	150	11.3
	19	62	144	11.3	60	145	10.9	58	146	10.6
	18	58	140	10.5	56	140	10.2	54	140	9.9
	17	53	134	9.8	51	135	9.4	49	135	9.1
2100	20	64	146	11.5	61	146	11.2	59	147	10.8
	19	59	141	10.8	57	142	10.4	55	142	10.1
	18	55	136	10.1	53	137	9.7	51	137	9.4
	17	51	131	9.3	49	131	9.0	47	131	8.7
	16	46	125	8.6	44	125	8.3	43	125	8.1

Figure 5-7. Cruise Performance (Sheet 5 of 7)

CRUISE PERFORMANCE

PRESSURE ALTITUDE 12,000 FEET

CONDITIONS:

3100 Pounds
Recommended Lean Mixture
Cowl Flaps Closed

NOTE

For best fuel economy, operate at the leanest mixture that results in smooth engine operation or at peak EGT if an EGT indicator is installed.

		20°C BELOW STANDARD TEMP -29°C			STANDARD TEMPERATURE -9°C			20°C ABOVE STANDARD TEMP 11°C		
RPM	MP	% BHP	KTAS	GPH	% BHP	KTAS	GPH	% BHP	KTAS	GPH
2400	18	65	149	11.7	62	150	11.3	60	151	10.9
	17	60	144	10.9	57	145	10.5	55	145	10.1
	16	55	138	10.0	53	139	9.7	51	139	9.4
	15	50	132	9.2	48	132	8.8	46	132	8.6
2300	18	62	147	11.3	60	148	10.9	58	148	10.6
	17	57	142	10.5	55	142	10.1	53	142	9.8
	16	53	136	9.7	51	136	9.3	49	136	9.0
	15	48	130	8.8	46	130	8.5	44	129	8.3
2200	18	60	144	10.9	58	145	10.5	56	145	10.2
	17	55	139	10.1	53	139	9.7	51	139	9.4
	16	50	133	9.3	48	133	9.0	47	133	8.7
2100	18	57	141	10.4	55	141	10.0	53	142	9.7
	17	52	136	9.6	50	136	9.3	49	136	9.0
	16	48	130	8.9	46	130	8.6	44	129	8.3

Figure 5-7. Cruise Performance (Sheet 6 of 7)

CRUISE PERFORMANCE

PRESSURE ALTITUDE 14,000 FEET

CONDITIONS:
3100 Pounds
Recommended Lean Mixture
Cowl Flaps Closed

NOTE

For best fuel economy, operate at the leanest mixture that results in smooth engine operation or at peak EGT if an EGT indicator is installed.

		20°C BELOW STANDARD TEMP - 33°C			STANDARD TEMPERATURE - 13°C			20°C ABOVE STANDARD TEMP 7°C		
RPM	MP	% BHP	KTAS	GPH	% BHP	KTAS	GPH	% BHP	KTAS	GPH
2400	16	57	143	10.3	54	143	10.0	52	143	9.6
	15	51	137	9.5	49	137	9.1	48	136	8.8
2300	16	54	141	10.0	52	141	9.6	51	141	9.3
	15	49	134	9.1	48	134	8.8	46	134	8.5
2200	16	52	138	9.6	50	138	9.3	48	138	9.0
	15	47	131	8.8	46	131	8.5	44	131	8.2
2100	16	50	134	9.2	48	134	8.9	46	134	8.6

Figure 5-7. Cruise Performance (Sheet 7 of 7)

RANGE PROFILE 45 MINUTES RESERVE 65 GALLONS USABLE FUEL

CONDITIONS:

3100 Pounds
Recommended Lean Mixture for Cruise
Standard Temperature
Zero Wind

NOTE:

This chart allows for the fuel used for engine start, taxi, takeoff and climb, and the distance during a normal climb up to 10,000 feet and maximum climb above 10,000 feet.

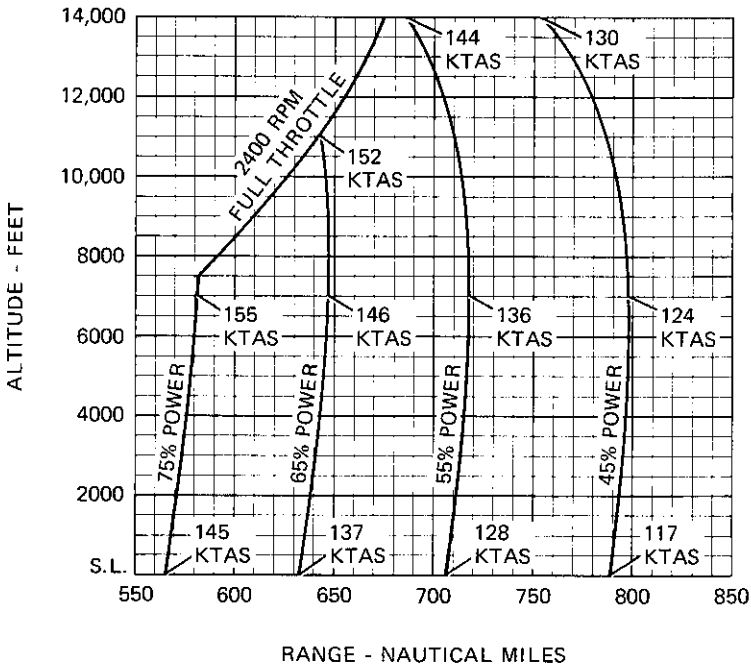

Figure 5-8. Range Profile (Sheet 1 of 2)

RANGE PROFILE

45 MINUTES RESERVE 88 GALLONS USABLE FUEL

CONDITIONS:
3100 Pounds
Recommended Lean Mixture for Cruise
Standard Temperature
Zero Wind

NOTE:
This chart allows for the fuel used for engine start, taxi, takeoff and climb, and the distance during a normal climb up to 10,000 feet and maximum climb above 10,000 feet.

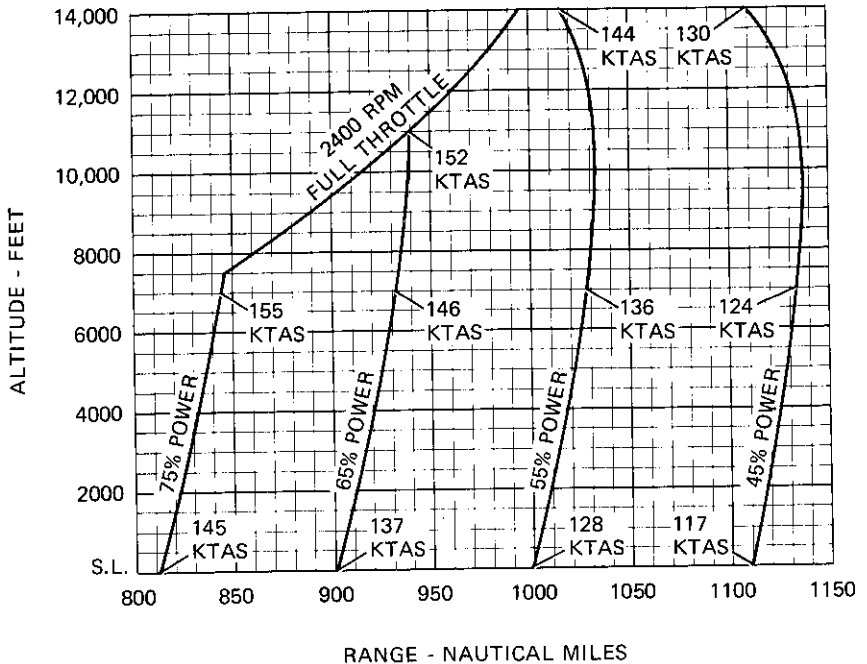

Figure 5-8. Range Profile (Sheet 2 of 2)

ENDURANCE PROFILE

45 MINUTES RESERVE
65 GALLONS USABLE FUEL

CONDITIONS:

3100 Pounds

Recommended Lean Mixture for Cruise

Standard Temperature

NOTE:

This chart allows for the fuel used for engine start, taxi, takeoff and climb, and the time during a normal climb up to 10,000 feet and maximum climb above 10,000 feet.

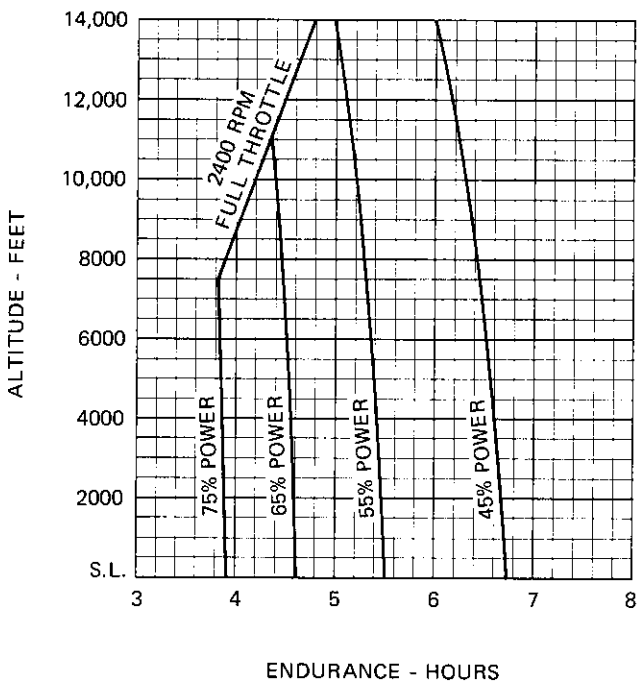

Figure 5-9. Endurance Profile (Sheet 1 of 2)

LANDING DISTANCE

SHORT FIELD

CONDITIONS:
 Flaps 40°
 Power Off
 Maximum Braking
 Paved, Level, Dry Runway
 Zero Wind

- NOTES:**
1. Short field technique as specified in Section 4.
 2. Decrease distances 10% for each 9 knots headwind. For operation with tailwinds up to 10 knots, increase distances by 10% for each 2 knots.
 3. For operation on a dry, grass runway, increase distances by 40% of the "ground roll" figure.

WEIGHT LBS	SPEED AT 50 FT KIAS	PRESS ALT FT	0°C		10°C		20°C		30°C		40°C	
			GRND ROLL	TOTAL TO CLEAR 50 FT OBS	GRND ROLL	TOTAL TO CLEAR 50 FT OBS	GRND ROLL	TOTAL TO CLEAR 50 FT OBS	GRND ROLL	TOTAL TO CLEAR 50 FT OBS	GRND ROLL	TOTAL TO CLEAR 50 FT OBS
3100	64	S.L.	570	1270	590	1305	610	1335	630	1370	650	1400
		1000	590	1305	610	1335	635	1375	655	1410	675	1440
		2000	610	1335	635	1375	655	1410	680	1450	700	1480
		3000	635	1375	660	1415	680	1450	705	1490	730	1530
		4000	660	1415	685	1455	705	1490	730	1530	755	1570
		5000	685	1455	710	1495	735	1535	760	1580	785	1620
		6000	710	1500	735	1540	760	1580	790	1625	815	1665
7000	735	1540	765	1585	790	1630	820	1675	845	1715		
8000	765	1585	795	1635	820	1675	850	1725	880	1770		

Figure 5-10. Landing Distance

ENDURANCE PROFILE 45 MINUTES RESERVE 88 GALLONS USABLE FUEL

CONDITIONS:

3100 Pounds
Recommended Lean Mixture for Cruise

Standard Temperature

NOTE:

This chart allows for the fuel used for engine start, taxi, takeoff and climb, and the time during a normal climb up to 10,000 feet and maximum climb above 10,000 feet.

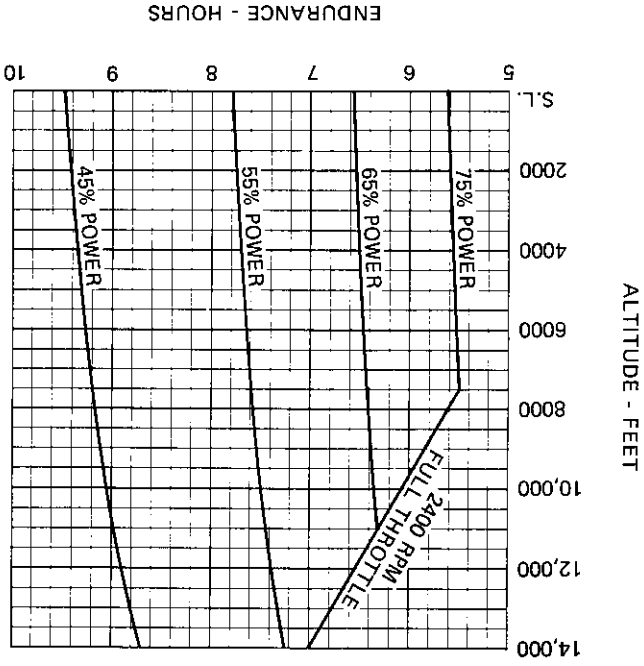

Figure 5-9. Endurance Profile (Sheet 2 of 2)

**AVIATION CONSULTANCY
and
RESEARCH SERVICES**

6.2 AEROPLANE WEIGHT

Aeroplane Type: Cessna R182 S/N 01741
Registration: VH-~~BDP~~ NDP
Issue: 1 Date: 27/11/89 Date of Expiry: N/A



EMPTY WEIGHT AND CENTRE OF GRAVITY DATA

Weight: 862 kg
Centre of gravity: 983 mm aft of the datum
Moment: 847585 kg-mm

Configuration:

unusable fuel, undrainable oil, four seat.

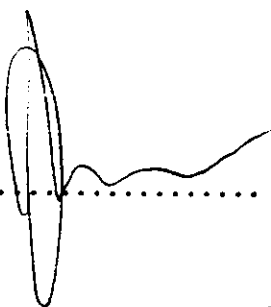
Approved ..  .. AV1

6.3 LOADING SYSTEM

Issue: 1 Date: 27/11/89

1. Applicable 6.2 Issue 1 only.
2. Observe Flight Manual weight limits.
3. Load front seats first, then load rear seats.

Baggage Limitations

4. With three POB maximum baggage is 70 kg.
5. With four POB maximum baggage is 50 kg.

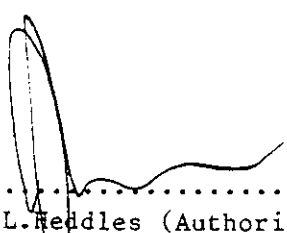
Approved:  ..
J.L. Fiddles (Authority AV1)

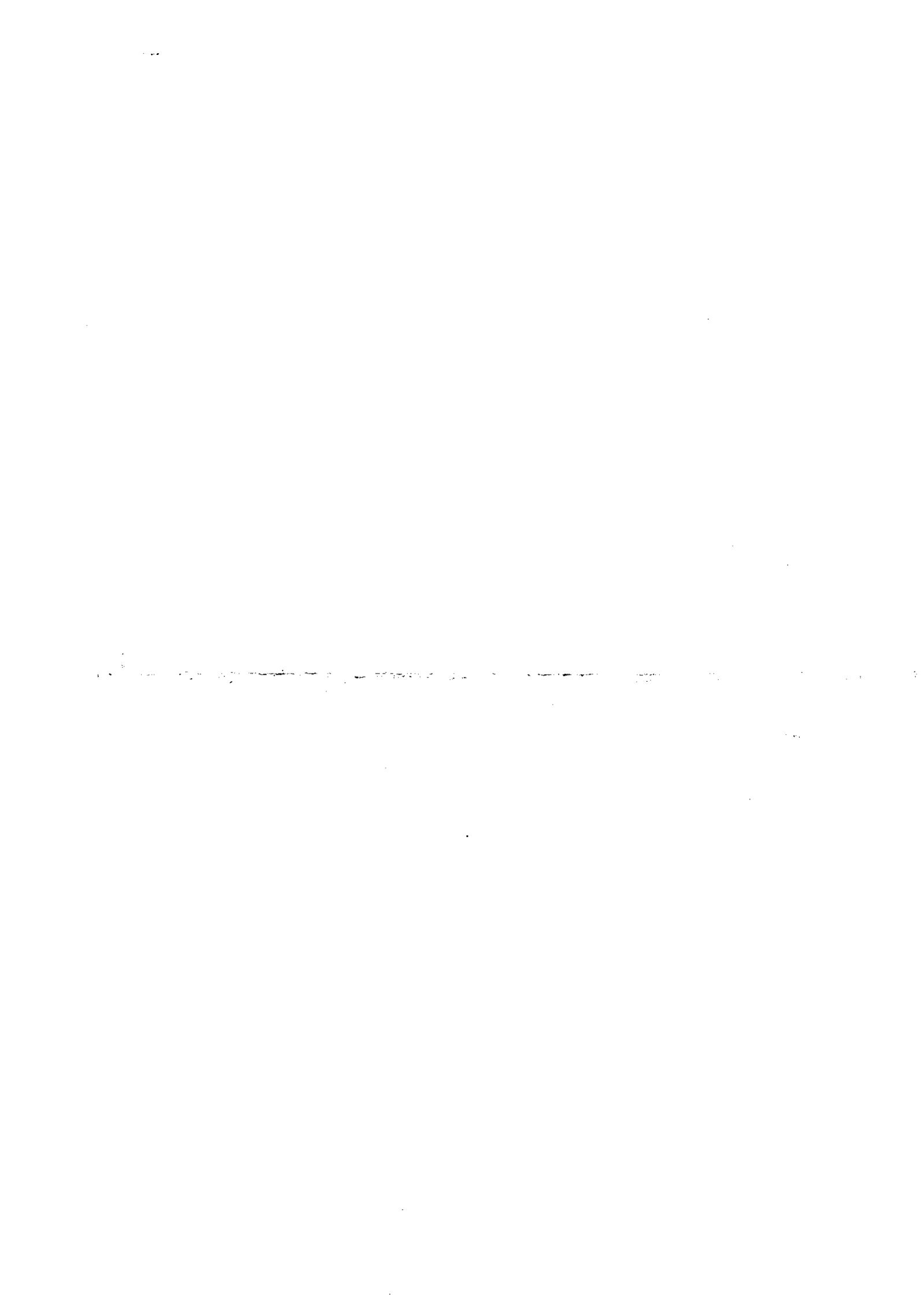

SECTION 6 WEIGHT & BALANCE/ EQUIPMENT LIST

TABLE OF CONTENTS

	Page
Introduction	6-3
Airplane Weighing Procedures	6-3
Weight And Balance	6-6
Baggage Tie-Down	6-6
Equipment List	6-15

INTRODUCTION

This section describes the procedure for establishing the basic empty weight and moment of the airplane. Sample forms are provided for reference. Procedures for calculating the weight and moment for various operations are also provided. A comprehensive list of all Cessna equipment available for this airplane is included at the back of this section.

It should be noted that specific information regarding the weight, arm, moment and installed equipment for this airplane as delivered from the factory can only be found in the plastic envelope carried in the back of this handbook.

It is the responsibility of the pilot to ensure that the airplane is loaded properly.

AIRPLANE WEIGHING PROCEDURES

1. Preparation:
 - a. Inflate tires to recommended operating pressures.
 - b. Remove the fuel tank sump quick-drain fittings and fuel selector valve drain plug to drain all fuel.
 - c. Remove oil sump drain plug to drain all oil.
 - d. Move sliding seats to the most forward position.
 - e. Raise flaps to the fully retracted position.
 - f. Place all control surfaces in neutral position.
2. Leveling:
 - a. Place scales under each wheel (minimum scale capacity, 1000 pounds).
 - b. Deflate the nose tire and/or lower or raise the nose strut to properly center the bubble in the level (see figure 6-1).
3. Weighing:
 - a. With the airplane level and brakes released, record the weight shown on each scale. Deduct the tare, if any, from each reading.
4. Measuring:
 - a. Obtain measurement A by measuring horizontally (along the airplane center line) from a line stretched between the main wheel centers to a plumb bob dropped from the firewall.
 - b. Obtain measurement B by measuring horizontally and parallel to the airplane center line, from center of nose wheel axle, left side, to a plumb bob dropped from the line between the main wheel centers. Repeat on right side and average the measurements.
5. Using weights from item 3 and measurements from item 4, the airplane weight and C.G. can be determined.
6. Basic Empty Weight may be determined by completing figure 6-1.

SECTION 6
 WEIGHT & BALANCE/
 EQUIPMENT LIST

CESSNA
 MODEL R182

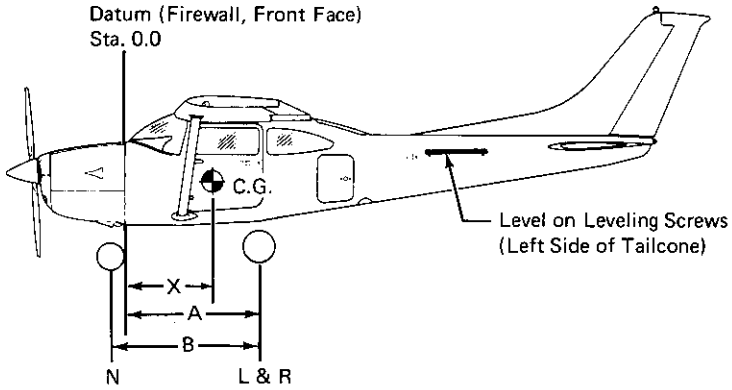

Scale Position	Scale Reading	Tare	Symbol	Net Weight
Left Wheel			L	
Right Wheel			R	
Nose Wheel			N	
Sum of Net Weights (As Weighed)			W	

$$X = \text{ARM} = \frac{(A) - (N) \times (B)}{W}; X = (\quad) - \frac{(\quad) \times (\quad)}{(\quad)} = (\quad) \text{ IN.}$$

Item	Weight (Lbs.) X C.G. Arm (In.) = Moment/1000 (Lbs.-In.)		
Airplane Weight (From Item 5, page 6-3)			
Add Oil: (9 Qts at 7.5 Lbs/Gal)	17	-15.7	-.3
Add: Unusable Fuel (4 Gal at 6 Lbs/Gal)	24	48.0	1.2
Equipment Changes			
Airplane Basic Empty Weight			

Figure 6-1. Sample Airplane Weighing

WEIGHT AND BALANCE

The following information will enable you to operate your Cessna within the prescribed weight and center of gravity limitations. To figure weight and balance, use the Sample Problem, Loading Graph, and Center of Gravity Moment Envelope as follows:

Take the basic empty weight and moment from appropriate weight and balance records carried in your airplane, and enter them in the column titled YOUR AIRPLANE on the Sample Loading Problem.

NOTE

In addition to the basic empty weight and moment noted on these records, the C.G. arm (fuselage station) is also shown, but need not be used on the Sample Loading Problem. The moment which is shown must be divided by 1000 and this value used as the moment/1000 on the loading problem.

Use the Loading Graph to determine the moment/1000 for each additional item to be carried; then list these on the loading problem.

NOTE

Loading Graph information for the pilot, passengers and baggage is based on seats positioned for average occupants and baggage items loaded in the center of these areas as shown on the Loading Arrangements diagram. For loadings which may differ from these, the Sample Loading Problem lists fuselage stations for these items to indicate their forward and aft C.G. range limitation (seat travel and baggage area limitation). Additional moment calculations, based on the actual weight and C.G. arm (fuselage station) of the item being loaded, must be made if the position of the load is different from that shown on the Loading Graph.

Total the weights and moments/1000 and plot these values on the Center of Gravity Moment Envelope to determine whether the point falls within the envelope, and if the loading is acceptable.

BAGGAGE TIE-DOWN

A nylon baggage net having six tie-down straps is provided as standard equipment to secure baggage in the area aft of the rear seat (Baggage A) and over the wheel well (Baggage B). Eight eyebolts serve as

attaching points for the net. Two eyebolts for the forward tie-down straps are mounted on the cabin floor near each sidewall just forward of the baggage door approximately at station 92; two eyebolts are installed on the cabin floor slightly inboard of each sidewall just forward of the wheel well approximately at station 109; and two eyebolts are mounted on the upper forward surface of the wheel well slightly inboard of each sidewall approximately at station 109. The two aft eyebolts are installed above the aft portion of the wheel well and slightly inboard of each sidewall approximately at station 124.

When the cabin floor (Baggage A) only is utilized for baggage, the four eyebolts located on the cabin floor may be used, or the two forward eyebolts on the cabin floor and the two eyebolts on the upper forward surface of the wheel well may be used. When the upper surface of the wheel well (Baggage B) only contains baggage, the two eyebolts on the upper forward surface of the wheel well and the two aft eyebolts above the aft portion of the wheel well should be used. When there is baggage in both areas, the two forward eyebolts on the cabin floor, the two eyebolts on the upper forward surface of the wheel well, and the two aft eyebolts above the aft portion of the wheel well should be utilized.

LOADING ARRANGEMENTS

*Pilot or passenger center of gravity on adjustable seats positioned for average occupant.
 Numbers in parentheses indicate forward and aft limits of occupant center of gravity range.

**Baggage area center of gravity.

- NOTES:
1. The usable fuel C.G. arm is located at station 46.5.
 2. The aft baggage wall (approximate station 134) can be used as a convenient interior reference point for determining the location of baggage area fuselage stations.

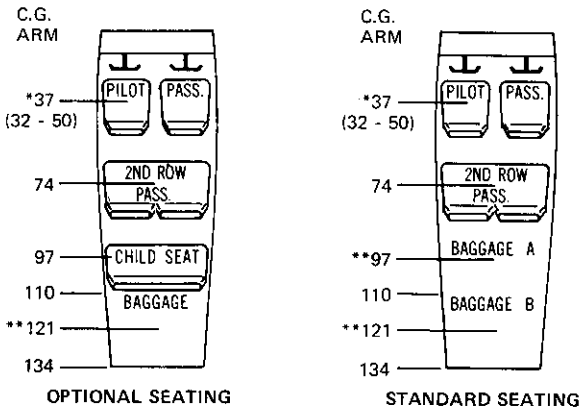
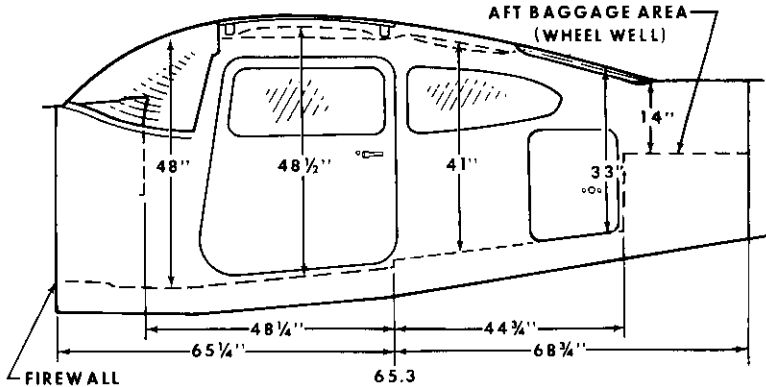

Figure 6-3. Loading Arrangements

CABIN HEIGHT MEASUREMENTS



DOOR OPENING DIMENSIONS

	WIDTH (TOP)	WIDTH (BOTTOM)	HEIGHT (FRONT)	HEIGHT (REAR)
CABIN DOOR	32"	36 1/2"	41"	38 1/2"
BAGGAGE DOOR	15 3/4"	15 3/4"	22"	20 1/2"

— WIDTH —
● LWR WINDOW LINE
* CABIN FLOOR

CABIN WIDTH MEASUREMENTS

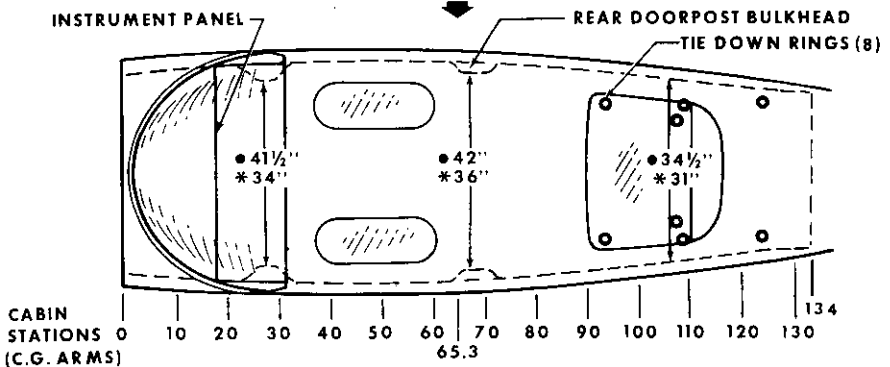

Figure 6-4. Internal Cabin Dimensions

SECTION 6
 WEIGHT & BALANCE/
 EQUIPMENT LIST

CESSNA
 MODEL R182

SAMPLE AIRPLANE	YOUR AIRPLANE	
	Weight (lbs.)	Moment (lb.-ins. /1000)
<p>SAMPLE LOADING PROBLEM</p> <p>1. Basic Empty Weight (Use the data pertaining to your airplane as it is presently equipped. Includes unusable fuel and full oil)</p> <p>2. Usable Fuel (At 6 Lbs./Gal.)</p> <p> Standard Tanks (88 Gal. Maximum)</p> <p> Reduced Fuel (65 Gal.)</p> <p>3. Pilot and Front Passenger (Sta. 32 to 50)</p> <p>4. Second Row Passengers</p> <p>5. Baggage (Area "A") or Passenger on Child's Seat (Station 82 to 110) 120 Lbs. Maximum</p> <p>6. Baggage - Aft (Area "B") (Station 110 to 134) 80 Lbs. Maximum</p> <p>7. RAMP WEIGHT AND MOMENT</p> <p>8. Fuel allowance for engine start, taxi and runup</p> <p>9. TAKEOFF WEIGHT AND MOMENT (Subtract step 8 from step 7)</p> <p>10. Locate this point (3100 at 136.0) on the Center of Gravity Moment Envelope, and since this point falls within the envelope, the loading is acceptable.</p>	1808	64.9
	528	24.6
	340	12.6
	340	25.2
	96	9.3
	3112	136.6
	-12	-.6
	3100	136.0

Figure 6-5. Sample Loading Problem

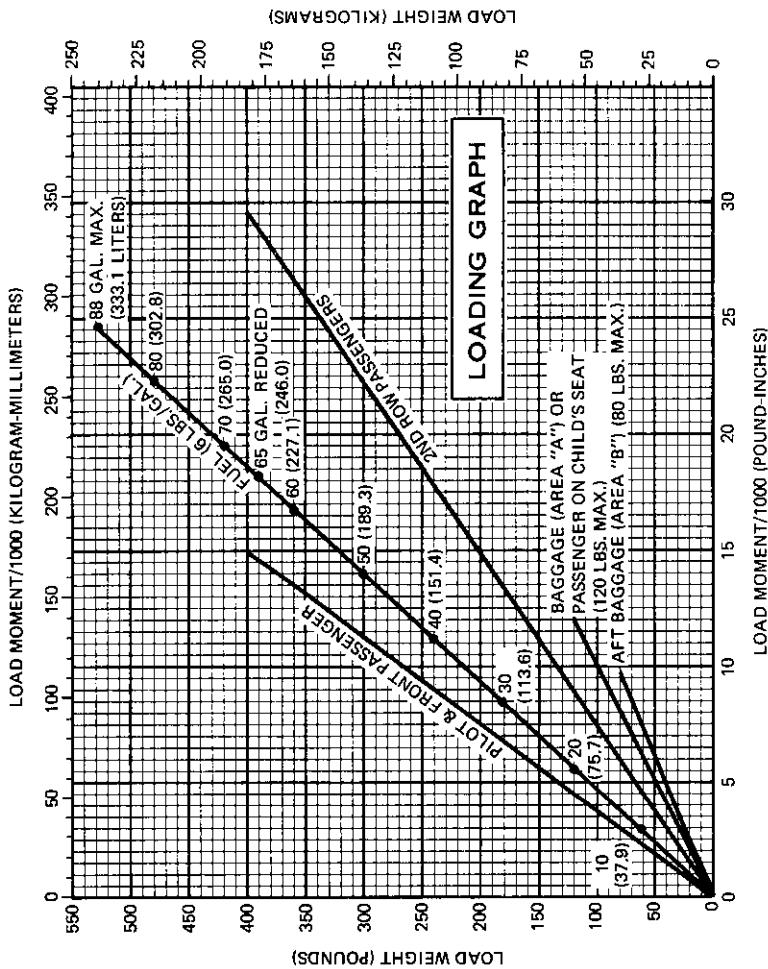

NOTES: Line representing adjustable seats shows pilot and front seat passenger center of gravity on adjustable seats positioned for an average occupant. Refer to the Loading Arrangements diagram for forward and aft limits of occupant C.G. range.

Figure 6-6. Loading Graph

SECTION 6
 WEIGHT & BALANCE/
 EQUIPMENT LIST

CESSNA
 MODEL R182

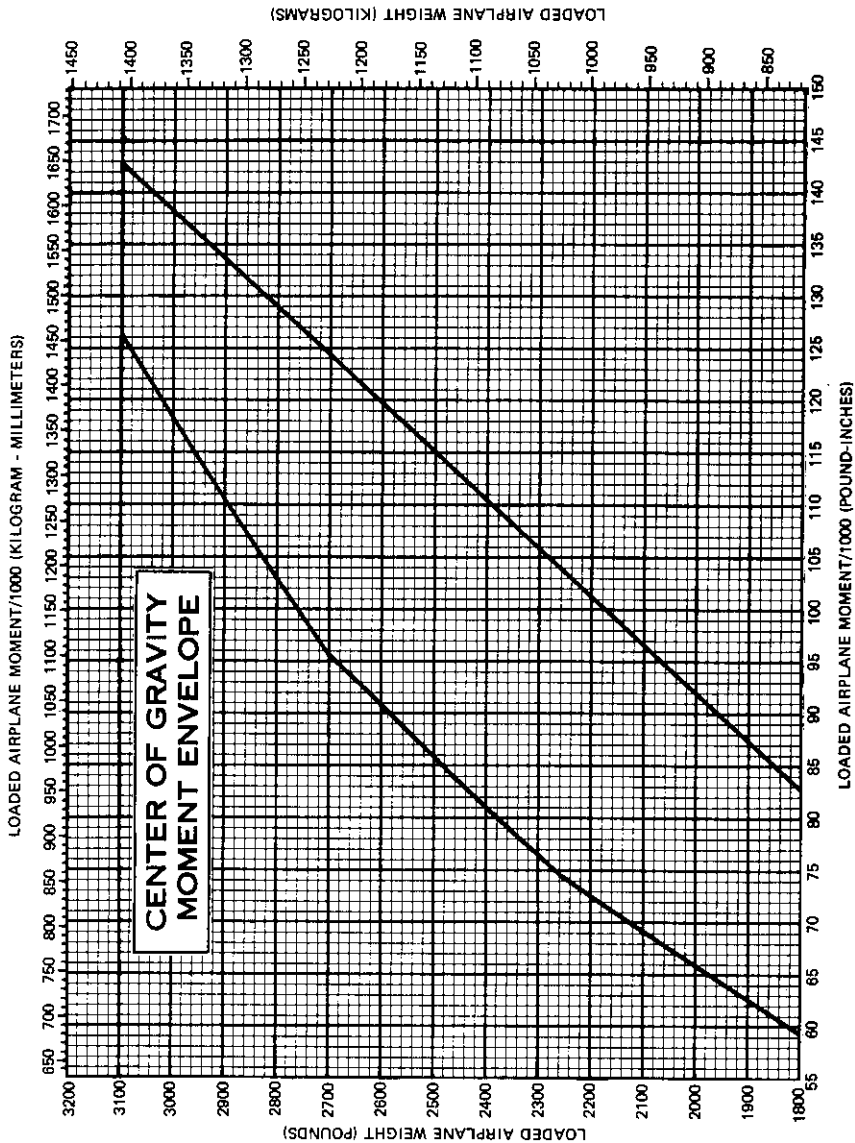

Figure 6-7. Center of Gravity Moment Envelope

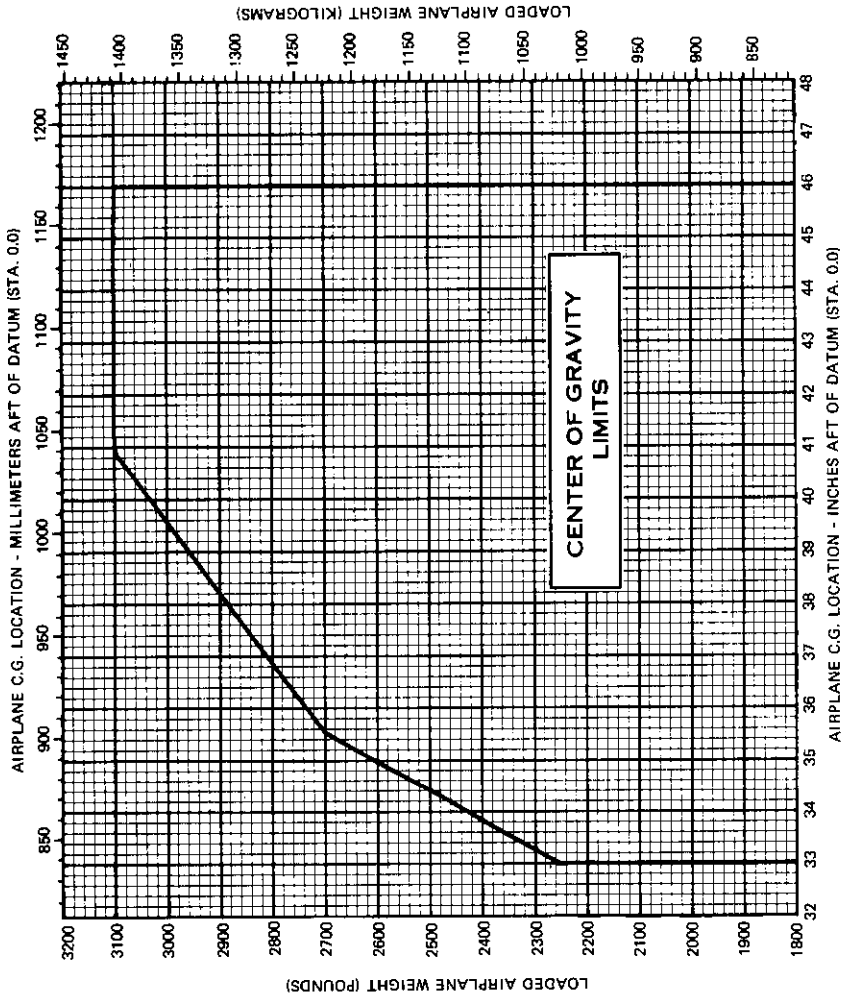

Figure 6-8. Center of Gravity Limits

EQUIPMENT LIST

The following equipment list is a comprehensive list of all Cessna equipment available for this airplane. A separate equipment list of items installed in your specific airplane is provided in your aircraft file. The following list and the specific list for your airplane have a similar order of listing.

This equipment list provides the following information:

An **item number** gives the identification number for the item. Each number is prefixed with a letter which identifies the **descriptive** grouping (example: A. Powerplant & Accessories) under which it is listed. Suffix letters identify the equipment as a required item, a standard item or an optional item. Suffix letters are as follows:

- R = required items of equipment for FAA certification
- S = standard equipment items
- O = optional equipment items replacing required or standard items
- A = optional equipment items which are in addition to required or standard items

A **reference drawing** column provides the drawing number for the item.

NOTE

If additional equipment is to be installed, it must be done in accordance with the reference drawing, accessory kit instructions, or a separate FAA approval.

Columns showing **weight (in pounds)** and **arm (in inches)** provide the weight and center of gravity location for the equipment.

NOTE

Unless otherwise indicated, true values (not net change values) for the weight and arm are shown. Positive arms are distances aft of the airplane datum; negative arms are distances forward of the datum.

NOTE

Asterisks (*) after the item weight and arm indicate complete assembly installations. Some major components of the assembly are listed on the lines immediately following. The summation of these major components does not necessarily equal the complete assembly installation.

SECTION 6
WEIGHT & BALANCE/
EQUIPMENT LIST

CESSNA
MODEL R182

ITEM NO	EQUIPMENT LIST DESCRIPTION	REF DRAWING	WT LBS	ARM INS
A01-R	A. POWERPLANT & ACCESSORIES ENGINE, LYCUMING C-540-J3C50 -BENDIX MAGNETO (IMPULSE COUPLING) -CARBURETOR, MARVEL SCHEBLER -STARTER, PRESTOLITE 24 VOLT -SPARK PLUGS (SHIELDED) -FUEL PUMP (MECHANICAL DRIVE) FILTER ASSEMBLY, CARBURETOR ALTERNATOR, 28 VOLT, 60 AMP ALTERNATOR, 28 VOLT, 95 AMP NET CHANGE -95 AMP ALTERNATOR -BALLAST (OR EQUIVILANT MOMENT) IS -REQUIRED WITH 95 AMP ALTERNATOR OIL COOLER, REMOTE OIL FILTER, SPIN-ON PROPELLER, MCCAULEY (B2D34C218/90DH8-9) PROPELLER, 3 BLADE MCCAULEY -PROPELLER, 3 BLADE -BALLAST (OR EQUIVILANT MOMENT) IS -REQUIRED WITH 3 BLADE PROPELLER GOVERNOR, PROPELLER (MCCAULEY D290-D3) SPINNER INSTALLATION, PROPELLER -SPINNER DOME ASSY -AFT BULKHEAD ASSY SPINNER INSTALLATION, 3 BLADE PROPELLER VACUUM SYSTEM, ENGINE DRIVEN -VACUUM PUMP -FILTER ASSEMBLY	225000U DOLN-2031 TYPE HA-6 MHE 4010 C294510-0901 C611503-0102 2201083 C611505-0101 2201074 106148 C294506-0102 C161008-0109 2252076 C161007-0301 2201074-2 C161031-0113 2250124 2250123-1 2250121-1 2252076-1 0706003-2 C231003 1201075-2	389.0* 11.5 5.1 18.0 2.6 1.7 0.8 10.7 6.8* 15.3 1.0 4.9 1.1 51.8 72.5* 68.5 4.0 3.0 3.4* 2.1 1.0 3.4 3.1* 1.8 0.3	-23.0* -6.5 -6.0 -33.0 -6.5 -4.6 -36.5 4.9* -36.5 230.0 -6.5 -7.5 -45.6 -37.2* -47.0 230.0 -36.0 -46.0* -50.5 -41.8 -46.0 -3.9* -7.5 11.5

ITEM NO	EQUIPMENT LIST DESCRIPTION	REF DRAWING	WT LBS	ARM INS
A70-S	PRIMING SYS. 4-CYL.	- -	6.7	-10.0
A75-S	OIL QUICK DRAIN VALVE	S-1951-5	6.2	-19.0
B01-R	B. LANDING GEAR & ACCESSORIES			
	WHEEL & TIRE ASSY., BRAKE ASSY MAIN (L)	4441107	37.8*	27.5*
	-WHEEL & TIRE ASSY (EACH SIDE)	C16301980208	15.8*	58.0*
	WHEEL ASSY. McCAULEY	C163008-0103	8.4	58.0
	TIRE 15X6.00X6, 6 PLY	C262006-0101	1.2	58.0
	TUBE	C262026-0101	1.2	55.0
	-BRAKE ASSY. -RH	C163032-0206	3.1	55.0
	-BRAKE ASSY. -LH	C163032-0205	3.1	55.0
B04-R-1	WHEEL & TIRE ASSY, 5.00X5 NOSE	1241159-104	9.4*	-7.2*
	-WHEEL ASSY CURVELAND 40-77	1441156-12	5.2	-7.2
	-TIRE, 6 PLY RATED BLACKWALL	C262005-0202	1.4	-7.2
	-TUBE	C262025-0101	1.2	-7.2
B04-R-2	WHEEL & TIRE ASSY, 5.00X5 NOSE GEAR	C1630180105	10.4*	-7.2*
	-WHEEL ASSY	C163009-0201	3.3	-7.2
	-TIRE, 6 PLY RATED BLACKWALL	C262009-0202	5.2	-7.2
	-TUBE	C262025-0101	1.4	-7.2
B04-R-3	WHEEL & TIRE ASSY, 5.00X5 NOSE GEAR	C1630180108	10.4*	-7.2
	-WHEEL ASSY	C163005-0201	3.8	-7.2
	-TIRE, 6 PLY RATED BLACKWALL	C262003-0212	5.2	-7.2
	-TUBE	C262025-0101	1.4	-7.2
B16-R	AXLE, STANDARD DUTY MAIN GEAR (SET UP 2)	0541124-1	1.9	58.0
C01-R	C. ELECTRICAL SYSTEMS			
	BATTERY, 24 VOLT, STANDARD DUTY	C614002-0101	23.2	136.0

**SECTION 6
WEIGHT & BALANCE/
EQUIPMENT LIST**

**CESSNA
MODEL R182**

ITEM NO	EQUIPMENT LIST DESCRIPTION	REF DRAWING	WT LBS	ARM INS
C01-0	BATTERY, 24 VOLT, HEAVY DUTY	C014002-0102	25.2	130.0
C04-R	ALTERNATOR CONTROL UNIT (WITH HIGH VOLTAGE PROTECTION AND LOW VOLTAGE SENSING)	C011005-0101	0.4	-0.3
C07-A	GROUND SERVICE PLUG RECEPTACLE	2270017-1	2.8	136.5
C10-A	ELECTRIC ELEVATOR TRIM INSTL (REQUIRES ALL-PURPOSE CONTROL WHEEL) -DRIVE ASSY -ACTUATOR ASSY (NET CHANGE)	2270028-1 -- 1260074-7	4.8* 2.3 NEGL	164.4* 220.0 --
C19-0	HEATING SYSTEM, PILOT & STALL WARNING SWITCH	0775724-3	0.5	26.5
C22-A	LIGHTS, INSTRUMENT POST	2201003	0.5	17.5
C23-A	LIGHTS, PANEL ELECTRO-LUMINESCENT	0770419	2.1	16.5
C25-A	MAP LIGHT, CONTROL WHEEL MOUNTED (REQUIRES E89-0 CHANGE FROM 2260126-1 TO 2260126-2)	2260126-2	0.2	22.5
C31-A	LIGHTS, COURTESY (NET CHANGE)	0700615-11	0.5	61.7
C34-S	FUEL PUMP, AUXILIARY (ELECTRIC)	C391506-0101	1.8	-1.2
C40-A	DETECTORS, NAVIGATION LIGHT (SET OF 2)	0701013-11-2	NEGL	--
C43-A	OMNI FLASHING BEACON LIGHT -LIGHT ASSY (IN FIN TIP) -FLASHER ASSY (IN FIN TIP) -LOADING RESISTOR	0701042-3 C621001-0102 C594502-0102 DR95-6	1.6* 0.7 0.4 0.2	208.6* 253.0 253.0 212.0
C46-A	STROBE LIGHTS INSTL. (NET CHANGE) -POWER SUPPLY INSTL -OPT WING TIPS (0723200-26, -27) REPLACES STU TIPS (072300-14, -15) WHICH INCLUDES LIGHT ASSY (SET OF TWO) -POWER UNIT	2201008-7 0701018-5E-0	3.5* 3.4	44.4* 44.4
C49-S	LIGHT INSTL, COWL MOUNTED LANDING & TAXI -LIGHT BULBS (SET OF 2)	C622006-0107 C622008-0102 2270002 4591	0.4 2.4 1.6* 1.0	42.0 46.7 -28.1 -37.0

ITEM NO	EQUIPMENT LIST DESCRIPTION	REF DRAWING	WT LBS	ARM INS
G. INSTRUMENTS				
D01-K	INDICATOR, AIRSPEED	C661064-0223	0.6	16.0
D01-O	INDICATOR, TRUE AIRSPEED (NET CHANGE)	1201108-19	0.2	16.5
D04-A	STATIC AIRMATE AIR SOURCE	0701028-1	0.3	14.4
D07-K	ALTIMETER, SENSITIVE	C661071-0101	0.7	16.5
D07-G-1	ALTIMETER, SENSITIVE (FEET & MILLIBARS)	C661071-0102	0.7	16.5
D07-G-2	ALTIMETER, SENSITIVE (20 FT. MARKINGS)	C661025-0102	0.7	16.5
D10-A-1	ALTIMETER INSUL. SECOND UNIT	1213681-1	0.8	16.0
D16-A-1	ENCODING ALTIMETER, INCHES HG. (REQUIRES RELOCATING STD. ALTIMETER)	1213752	3.0	14.0
D10-A-2	ENCODING ALTIMETER, FEET AND MILLIBARS (REQUIRES RELOCATING STANDARD ALTIMETER)	1213752	3.0	14.0
D16-A-3	ALTITUDE ENGINEER (BLIND)(UCES NOT REQUIRE PANEL MOUNTING)	0701099-5	1.5	13.6
D22-A	GAGE, CARBURETOR AIR TEMPERATURE	2201005-1	1.1	16.4
D25-S	ELECTRIC CLOCK	C664508-C102	0.4	16.6
D25-U	ELECTRIC CLOCK, DIGITAL READOUT	C664511-0101	0.4	16.6
D28-K	COMPASS, MAGNETIC & MOUNT	1213679-5	1.1	20.5
D34-R	INSTRUMENT CLUSTER, ENGINE & FUEL	C669545-0109	1.3	16.5
D49-A	INDICATOR INSTALLATION, ECONOMY MIXTURE -EGT INDICATOR -THERMOCOUPLE PROBE -THERMOCOUPLE LEAD WIRE (IC)	0750609-3 C668201-0211 C668501-0204 C668501-0206	0.7* 0.4 0.1 0.1	8.2* 17.1 -20.3 -0.3

**SECTION 6
WEIGHT & BALANCE/
EQUIPMENT LIST**

**CESSNA
MODEL R182**

ITEM NO	EQUIPMENT LIST DESCRIPTION	REF DRAWING	WT LBS	ARM INS
D58-R	GAGE, MANIFOLD AND FUEL PRESSURE, 2 NEEDLE	C662038-0103	1.0	16.5
D64-S	GYRO SYSTEM INSTL. (NON AUTO-PILOT) -DIRECTIONAL INDICATOR -ATTITUDE INDICATOR -HOSES, FITTINGS, SCREWS, CLAMPS & ETC.	0701030-2 C661075-0101 C661076-0102	5.8* 2.5 2.0 1.3	13.6* 14.0 14.6 11.5
C64-U-1	GYRO SYSTEM FOR NAV-U-MATIC 300A AUTOPILOT -DIRECTIONAL INDICATOR -ATTITUDE INDICATOR	0701038 40760-0104 C661076-0102	6.2* 2.7 2.0	13.4* 13.4 14.6
D64-C-2	GYRO SYSTEM FOR NCM 400B NON SLAVED DG -DIRECTIONAL INDICATOR -ATTITUDE INDICATOR	40760-0104 37570-0105	6.3* 2.3	13.4* 14.6
D64-C-3	GYRO SYSTEM FOR NCM 40CB SLAVED DG -DIRECTIONAL INDICATOR, SLAVED -ATTITUDE INDICATOR	44760-0000 37570-0105	7.1* 3.5 2.3	13.4* 13.4 14.6
D67-A	HOURMETER, INSTALLATION -RECORDING INDICATOR -OIL PRESSURE SWITCH	2201004-1 C664503-0101 S1711-1	0.6* 0.2 0.2	7.8* 16.5 -1.0
D82-S	GAGE, OUTSIDE AIR TEMPERATURE	C668507-0101	0.1	28.5
D85-R	TACHOMETER INSTALLATION, ENGINE -RECORDING TACH INDICATOR	2206001 C668020-0117	0.9* 0.7	13.8* 16.9
D88-S-1	INDICATOR, TURN COORDINATOR (28 VOLT ONLY)	C661003-0507	1.0	15.0
D88-S-2	INDICATOR, TURN COORDINATOR (10-30 VOLT)	C661003-0506	1.0	15.0
D88-U-1	INDICATOR, TURN COORDINATOR (FOR N.O.M.'S)	42520-0028	1.3	15.0
D91-S	INDICATOR, RATE OF CLIMB E. CABIN ACCOMMODATIONS	C661080-0101	1.0	15.4
E05-R	SEAT, ADJUSTABLE FGRE & AFT - PILOT	1214124-13	13.0	44.0

ITEM NO	EQUIPMENT LIST DESCRIPTION	REF DRAWING	WT LBS	ARM INS
E05-C	SEAT, ARTICULATING VERT. ADJ. - PILOT	2214013-13	24.0	41.5
E07-S	SEAT, ADJUSTABLE FURE & AFT - CO-PILOT	1214124-13	13.0	44.0
E07-B	SEAT, ARTICULATING VERT. ADJ. - CO-PILOT	2214013-14	24.0	41.5
E09-S	SEAT, 2ND ROW BENCH	2214004-13	23.0	80.5
E11-A	SEAT INSTALLATION, CHILDS (NET FACTORY INSTALLED) -SEAT ASSY, FOLDAWAY (CAP. 120 LB MAX) -BELT ASSY, LAP	2201001 0714050 S1748-5	8.4* 8.9 0.9	103.5* 104.4 101.1
E15-K	BELT ASSY, LAP (PILOT SEAT)	S2275-103	1.0	37.0
E15-S	SHOULDER HARNESS ASSY, PILOT	S2275-201	0.6	37.0
E19-D	INERTIA KEEL INSUL., PILOT & CO-PILOT (NET CHANGE)	0701077-1	3.0	92.0
E25-S	BELT & SHOULDER HARNESS ASSY, CO-PILOT	S2275-3	1.6	37.0
E27-S	BELT ASSY, 2ND ROW OCCUPANTS (SET OF 2)	S1748-40 & -41	1.6	74.5
E27-O	SHOULDER HARNESS INSTL. REAR (EXCHANGE) (S2275-7 HARNESS REPLACES STANDARD BELT, SEE E27-S FOR STANDARD BELTS)	0701026-1	1.8	74.5
E35-A-1	INTERIOR, VINYL SEAT COVERS (NET CHANGE)	CES-1249	0.0	-
E35-A-2	INTERIOR, LEATHER SEAT COVERS (NET CHANGE)	CES-1249	2.0	62.3
E35-A-3	SEAT COVERING-LEATHER & FABRIC	CES-1249	1.0	62.3
E35-A-4	INTERIOR, UPHOLSTERY SIDE PANELS LEATHER STYLING (NET CHANGE)		1.0	65.0
E35-A-5	INTERIOR, UPHOLSTERY SIDE PANELS, LEATHER AND VINYL OR FABRIC STYLING (NET CHANGE)		0.5	65.0
E37-U	OPENABLE REAR CABIN DOOR WINDOW (NET CHANGE)	0701065-8	2.3	47.0

**SECTION 6
WEIGHT & BALANCE/
EQUIPMENT LIST**

**CESSNA
MODEL R182**

ITEM NO	EQUIPMENT LIST DESCRIPTION	REF DRAWING	WT LBS	ARM INS
E39-A	WINDOWS, OVERHEAD CABIN TOP (NET CHANGE)	0701017-4	0.6	45.5
E43-A	VENTILATION SYSTEM, 2ND ROW SEATING	2201046-1	2.3	57.7
E47-A	OXYGEN SYSTEM, INCLUDES MASKS -CYLINDER & REGULATOR, EMPTY -OXYGEN - 48 CU FT @ 1800 PSI -OXYGEN MASKS - PILOT & 3 PASSENGERS	2201066-7 C166601-0601	39.0* 25.0 4.0 1.1	132.9* 143.6 143.6 61.1
E49-A	CUP HOLDER, KICKABLE (SET OF 2)	1201124-2 & -3	0.1	16.0
E50-A	HEADREST, 1ST ROW (INSTALLED ARM) (EACH)	1215073-1	0.9	47.0
E51-A	HEADREST, 2ND ROW (INSTALLED ARM) (EACH)	1215073-1	0.9	87.0
E55-S	SUN VISORS (SET OF 2)	0514166	3.2	33.0
E59-A	APPROACH PLATE HOLDER	0715083-1	0.1	27.5
E65-S	BAGGAGE TIE DOWN NET	1215171-1	0.5	122.0
E75-A	STRETCHER PORTABLE (AVAILABLE FROM DEALER ONLY)(USE ACTUAL INSTALLED WT & ARM)	0700164	-	-
E85-A	CONTROLS INSTALLATION, DUAL (CO-PILOT)	0760101-7	6.7	14.1
E86-A	CABIN AIRCIRCULATING SYSTEM -COMPRESSOR ASSEMBLY (SANYO) -CONDENSOR (ARA) -EVAPORATOR & BLOWER ASSY (ARA)	2201020 C413001-0101 0519258 0507574	68.9* 18.4 5.3 9.1	52.0* -37.1 120.2 124.0
E89-U	CONTROL WHEEL -ALL PURPOSE (EXCHANGE) PILOT ONLY, INCLUDES MIC SWITCH AND PANEL MOUNTED AUX MIC JACK WITH WIRING AND CHANGES 2260126-1 CONTROL WHEEL TO 2260126-2 CONTROL WHEEL	2260126-2	0.2	22.5
E93-R	HEATING SYSTEM, CABIN & CARBURETOR AIR F. PLACARDS, WARNINGS & MANUALS	-	13.5	-4.8

ITEM NO	EQUIPMENT LIST DESCRIPTION	REF DRAWING	WT LBS	ARM INS
F01-R	PLACARD, OPERATIONAL LIMITATIONS--VFR DAY	0505087-7	NEGL	--
F01-U-1	PLACARD, OPERATIONAL LIMITATIONS--VFR DAY--NIGHT	C505087-8	NEGL	--
F01-U-2	PLACARD, OPERATIONAL LIMITATIONS VFR--IFR/DAY-NIGHT	0505087-9	NEGL	--
F04-R	INDICATION, STALL WARNING UNIT (USES KALIC SPEAKER FOR AUDIBLE IDNE)	1270733-1	0.3	45.0
F10-S	CHECK LIST, PILOTS (STOWED)	U6070	NEGL	--
F10-R	PILOT'S OPERATING HANDBOOK AND FAA APPROVED AIRPLANE FLIGHT MANUAL, STOWED	01198-13PH	1.3	--
	C. AUXILIARY EQUIPMENT			
G01-A	TAILCONE LIFT HANDLES (SET OF 2)	2201009	1.0	186.5
G07-A	HOISTING RINGS (DEALER INSTALLED)	0700612-1	1.5	45.6
G10-S	FUEL SAMPLER CUP (STOWED ITEM)	S-2107-1	0.1	--
G13-A	CORRGUSION PROOFING, INTERNAL	0760007-2	7.1	70.0
G16-A	STATIC DISCHARGERS (SET OF 10)	1201131-2	0.4	130.5
G19-A	STABILIZER ABRASION BOOTS	0500041-5	2.7	206.0
G22-0	TOWBAR, AIRCRAFT, TELESCOPING HANDLE	0700315	2.0	97.0
G25-S	PAINT, OVERALL COVER--EXTERIOR -OVERALL BASE COLOR (102773 SC IN) -COLORED STRIPE	2204004	13.0* 12.1 0.5	91.9* 91.5 82.1
G28-A	JACK PADS (UNDERSIDE OF WING)(SET OF 2) INSTALLED ARM SHOWN (NORMALLY STOWED)	1200031	0.2	37.0

SECTION 6
WEIGHT & BALANCE/
EQUIPMENT LIST

CESSNA
MODEL R182

ITEM NO	EQUIPMENT LIST DESCRIPTION	REF DRAWING	WT LBS	ARM INS
G31-A	CABLES, CORROSION RESISTANT (NET CHANGE)	0760007-2	0.0	--
G55-A-1	FIRE EXTINGUISHER, HAND TYPE (FOR USE WITH STANDARD PILOT SEAT)	0701014-1	4.8	35.0
G55-A-2	FIRE EXTINGUISHER, HAND TYPE (FOR USE WITH VERTICALLY ADJUSTING PILOT SEAT)	0701014-2	5.0	29.0
G58-A	REFUELING STEP & HANDLE (BOTH SIDES)	0701127-1	1.8	15.3
G61-A	WRITING TABLE	1715072-1	3.6	61.5
G67-A	RUDDER PEDAL EXTENSIONS (DEALER INSTL.)	0701048-1	2.3	8.0
G89-A	WINTERIZATION KIT, ENGINE	2201012-1	0.3*	-40.0
	H. AVIONICS & AUTOPILOTS			
H01-A-1	CESSNA 300 ADF WITH BFO -RECEIVER K-546E -INDICATOR (LN-346A) -LOOP ANTENNA -RECEIVER MOUNT -SENSE ANTENNA	3910159-20 41240-0001 40980-1001 41000-1000 40900-0000 3960140-1	6.6* 2.3 0.9 1.4 0.5 0.3	22.4* 13.0 15.5 35.6 13.0 112.2
H01-A-2	CESSNA 400 ADF WITH BFO -ADF RECEIVER WITH -INDICATOR (LN-346A) -ADF LOOP ANTENNA -ADF SENSE ANTENNA -MOUNT & INSTALLATION ITEMS	3910160-19 43090-1028 40980-1001 41000-1000 3960140-1	7.5* 3.3 0.9 1.4 0.3 2.8	21.2* 13.0 15.5 32.2 112.2 11.0
H03-A	AM/FM STEREO RECEIVER & CASSETTE PLAYER -HEADSET (SET UP 2, 4 MAY BE USED) -STEREO RECEIVER INSTALLATION -ANTENNA, WIRING & MISC. ITEMS	3910209-2 C596532-0101 3930194	5.5* 2.2 1.2 6.4*	32.8* 17.5 13.5 27.0*
H04-A-1	DME INSTL. NAKCO DME 190	3910166-11		

ITEM NO	EQUIPMENT LIST DESCRIPTION	REF DRAWING	WT LBS	ARM INS
H04-A-2	-TRANSCIEIVER & MOUNT -ANTENNA INSTL. -WIRING, COOLING TUBING & MISC ITEMS	3312-406 3960133	5.2 0.2 1.0	12.0 188.0 72.9
H04-A-2	CESSNA 400 DME INSTL -RECEIVER-TRANSMITTER (REMOTE MOUNTED) MOUNT 44088 44088 3960134-1 -ANTENNA INSTL -CONTROL UNIT MOUNTING CLAMP -WIRING & MISC ITEMS	3910167-18 44000 44088 3960134-1 44020-1100 41038-0000	16.1* 9.0 0.8 0.2 1.5 0.1 0.1 5.2	105.1* 132.4 132.4 188.0 12.0 16.5 83.9
H04-A-3	COLLINS DME 451 -RECEIVER/TRANSMITTER, TCR-451 -INDICATOR/CONTROL, IND-450C -ANTENNA, ANT-451	622-3670-001 622-5588-001 622-4011-001	10.0* 5.3 0.9 0.2	97.9* 132.4 14.0 188.0
H05-A-1	CESSNA 400 R-NAV INSTL. -COMPUTER (R-478A) -MOUNT -INDICATOR INSTALLATION, 43910-1000 IND. REPLACES REGULAR 300 OR 400 IND. -CABLE INSTALLATION	3910168-17 44100-0000 44091-0000 3930182-8	6.1* 5.8 0.3 -0.5 - 0.4	11.9* 12.2 12.5 15.5 - 10.0
H05-A-2	FOSTER R-NAV INSTALLATION (W/CESSNA 400 OR NARCO 190 DME -R-NAV RECEIVER-INDICATOR (511)	3910203	3.4* 2.4	12.2* 12.5
H05-A-3	COLLINS R-NAV, ANS-351C	622-5579-001	4.3	12.3
H07-A	CESSNA 400 GLIDESLOPE -RECEIVER R-443B -MOUNT -VORAILS INDICATOR IN-386A (EXCHANGE) (ACTUAL WT IS 1.7 LB) -ANTENNA (MOUNTED ON UPPER WINDSHIELD) -WIRING	3910157-11 42100-0000 36450-0000 46360-2000	5.1* 2.1 0.3 0.2	107.2* 132.1 132.1 115.5
H08-A-1	AUTO RADIAL CENTERING INDICATOR ARC/LDC EXCHANGE FOR VOR/LDC IN ITEM H22-A (WT NET CHANGE) -ARC/LDC INDICATOR ADDED	1200098-1 3950136 3910196-1	0.2 2.4 0.2*	26.1 89.1 15.5*
		46860-1200	1.8	15.5

SECTION 6
WEIGHT & BALANCE/
EQUIPMENT LIST

CESSNA
MODEL R182

ITEM NO	EQUIPMENT LIST DESCRIPTION	REF DRAWING	WT LBS	ARM INS
H08-A-2	-VOR/LCC INDICATOR DELETED AUTO RADIAL CENTERING INDICATOR ARC/ILS EXCHANGE FOR VOR/ILS, USED WITH H07-A ONLY (WT NET CHANGE) -ARC/ILS INDICATOR ADDED -VOR/ILS INDICATOR DELETED	46860-1000 3910196-2	-1.6 0.2*	15.5 15.5*
H09-A-1	HSI NON-SLAVED INDICATOR INSTALLATION WITH DIRECTIONAL AND NAV INDICATORS NET CHANGE -HSI INDICATOR IG-832C -HSI VOR CONVERTER INSTALLATION -CONVERTER CABLE -N.O.M. DIRECTIONAL IND. DELETED -VOR/ILS INDICATOR DELETED	44690-2000	4.4 1.1 2.1 2.7 -1.7	13.0 162.7 94.4 13.4 15.5
H09-A-2	HSI SLAVED INDICATOR INSTALLATION WITH DIRECTIONAL AND NAV INDICATORS NET CHANG -HSI INDICATOR (SLAVED) IG-832B -VOR/ILS CONVERTER INSTALLATION -SLAVING SYSTEM -N.O.M. DIRECTIONAL INDICATOR DELETE -VOR/ILS INDICATOR DELETED	44690-0000	6.3* 4.9 1.1 3.1 -2.7 -1.7	86.9* 13.0 165.7 178.6 12.4 15.5
H11-A	SUNAIR ASB-125 SINGLE SIDE BAND HF XCVR -TRANSCIVER ASB-125 -POWER SUPPLY PA1C10A -POWER SUPPLY MOUNT -ANTENNA COUPLER CU-110 -ANTENNA COUPLER SUPPORTS -ANTENNA INSTALLATION -WIRING	3910158-39 99681 99683 99916 99816 2270096-1,-2 3960117-1 3950136	24.7* 5.3 8.5 0.4 4.9 0.2 0.3 5.1	97.3* 12.5 128.3 128.3 145.0 148.0 152.1 80.3
H13-A	CESSNA 400 MARKER BEACON -RECEIVER (R-402A) -ANTENNA INSL.	3910164-26 42410-5128 3960126-1	2.8* 0.7 1.0	93.5* 11.5 178.6
H16-A-1	CESSNA 300 TRANSPONDER -TRANSCIVER (RT-359A) -MOUNT BOX -ANTENNA -WIRING, COOLING TUBING & MISC ITEMS	3910127-28 41420-0028 3960136-1 -	3.9* 2.7 0.3 0.2 0.6	16.1* 12.5 12.5 56.3 20.3

ITEM NO	EQUIPMENT LIST DESCRIPTION	REF DRAWING	WT LBS	ARM INS
H16-A-2	CESSNA 400 TRANSPONDER (SAME AS H16-A-1 EXCEPT 3930126-16 RT-459A XCVR INSTL REPLACES 3930132-15 NEGL CHNG)	3910128-25	3.9*	16.1*
H22-A-1	FIRST 300 NAV/COM; 720 CHANNEL COM VOR/LOC REQUIRES H34-A FOR FIRST UNIT AND H37-A FOR SECOND UNIT INSTALLATION -RECEIVER-TRANSMITTER (RT-385A) -VOR/LOC INDICATOR (LIN-385A) -MOUNT, COOLING TUBE & MISC ITEMS	3910183-20 46660-1000 46860-1000	8.0* 5.5 1.6 0.9	12.8* 12.5 15.5 9.7
H22-A-2	CESSNA 400 NAV/COM WITH 300 SERIES INDI- CATOR; REQUIRES H34-A FOR FIRST UNIT AND H37-A FOR SECOND UNIT INSTALLATION -RECEIVER-TRANSMITTER (RT-485A) -VOR/LOC INDICATOR (LIN-385A) -MOUNT, COOLING TUBE & MISC ITEMS	3910189 47360-1000 46860-1000	8.0* 5.5 1.6 0.9	12.8* 12.5 15.5 9.7
H28-A-1	EMERGENCY LOCATOR TRANSMITTER -TRANSMITTER ASSY (D & M DMELT-6-1) -ANTENNA	0470419-27 C589511-0117 C589511-0109	3.5* 3.3 0.1	152.2* 121.5 168.0
H28-A-2	EMERGENCY LOCATOR TRANSMITTER (USED IN CANADA) -TRANSMITTER ASSY (D & M DMELT-6-1C) -ANTENNA	0470419-28 C589511-0113 C589511-0109	3.5* 3.3 0.1	152.2* 151.5 168.0
H31-A-1	NAV-O-MATIC 200A INSTALLATION (AF-295B) -CONTROLLER-AMPLIFIER -TURN COORDINATOR (D88-Q-1) NET CHANGE -WING SERVO INSTALLATION	3910162-24 43610-102 42320-0028 0700215	8.8* 1.1 0.3 5.4	49.4* 13.5 13.5 69.8
H31-A-2	NAV-O-MATIC 300A INSTALLATION (AF-395-A) -CONTROLLER-AMPLIFIER (C-395A) -CYO INSTALLATION NET CHANGE (ITEM D64-U-1 REPLACES ITEM D64-S) -TURN COORDINATOR (D88-Q-1) NET CHANGE -WING SERVO INSTALLATION	3910163-24 42660-1202 0701038-1 42320-0028 0700215-4	9.5* 1.4 0.4 5.4	47.8* 13.5 10.5 69.8
H31-A-3	NAV-O-MATIC 300A W/NON SLAVED HSI -CONTROLLER-AMPLIFIER (TYPE C-395A)	3910195-5 42660-2202	12.5* 1.4	61.0* 15.5

SECTION 6
WEIGHT & BALANCE/
EQUIPMENT LIST

CESSNA
MODEL R182

ITEM NO	EQUIPMENT LIST DESCRIPTION	REF DRAWING	WT LBS	ARM INS
H31-A-4	-HG9-A-1 NON-SLAVED HSI INSTALLATION	- -	3.2	96.7
	-D88-U-1 TURN COORDINATOR NET CHANGE	42320-0028	0.3	15.5
	-WING SERVO INSTALLATION	0700215	5.4	69.8
	-MISC ITEMS	42320-0028	2.2	22.6
	CESSNA 400B AUTOPILOT WITH HSI INSTL.	3910212	-	-
	-WITH NON-SLAVED HSI		47.8*	106.3*
	-CONTROLLEX C-590A		1.3	101.6*
	-AILERON ROLL ACTUATOR PA-495A-2	37860-1128	4.2	68.0
	-PITCH ACTUATOR PA-495A-2	43989-4801	4.2	157.4
	-ELEVATOR TRIM ACTUATOR TA-495A	45850-3913	2.3	220.0
H31-A-5	-AUTOPILOT ACCESSORY UNIT	- -	1.0	14.0
	-HG9-A-1 NON-SLAVED HSI INSTALLATION		3.2	96.7
	-HG9-A-2 SLAVED HSI INSTALLATION		2.3	86.9
	-SLAVING SYSTEM	4469C-0C0C	3.1	130.0
	-BATTERY CHANGE TO HEAVY DUTY BATTERY		3.9	176.6
	-COMPUTER-AMPLIFIER	42680-0009	2.8	151.4
	-MISC ITEMS, CABLES & HARDWARE	- -	17.6	85.6
	CESSNA 400B AUTOPILOT	3910212		
	-WITH NON-SLAVED DIRECTIONAL INDICATOR		39.0*	114.0*
	-WITH SLAVED DIRECTIONAL INDICATOR		42.2*	111.0
H33-A	-CONTROLLEX		1.5	15.0
	-PITCH ACTUATOR PA-495A-2	37900-1128	4.2	157.4
	-ROLL ACTUATOR PA-495A-2	45850-3913	4.2	157.4
	-PITCH TRIM ACTUATOR PA-495A-2	43989-4801	2.3	88.0
	-COMPUTER	42680-0007	2.3	220.0
	-D64-U-2 GYROS FOR NOM 400B NON SLAVED		5.8	151.4
	-D64-U-3 GYROS FOR SLAVED D.G.		6.5	13.4
	-SLAVING SYSTEM FOR SLAVED D.G.		7.1	13.4
	-COI-U HEAVY DUTY BATTERY NET CHANGE		3.0	176.6
	-D64-S STANDARD GYROS DELETED		2.0	130.0
H34-A	-MISC ITEMS		-5.8	113.6
	INTERCOM INSTALLATION	3910210	16.5	98.8
	(REQUIRES 885-A DUAL CONTROLS INSTL.)		2.9*	15.0*
	-JACK INSTALLATION FOR MICROPHONE	3970150	0.3	18.0
-H52-A-2 HEADPHONE-MIKE SET, 2 INCLUDED	C596531-0101	2.2	14.0	
-INTERCOM P/C BOARD ASSY	3970149	0.1	14.0	
BASIC AVIONICS KIT (USED AND AVAILABLE)	3910186-14	7.2*	53.7*	

ITEM NO	EQUIPMENT LIST DESCRIPTION	REF DRAWING	WT LBS	ARM INS
	ONLY WITH LIST OPERATING NAV/COM) -BUS BAR ASSY INSTL -NOISE FILTER INSTL -OMNI ANTENNA INSTL -VHF ANTENNA INSTL -AUDIO CONTROL PANEL INSTL -HEADSET INSTL -MICROPHONE INSTL -ANTENNA ADAPTOR -FIRST NAV/COM INSTL. COMPONENTS -CABLE INSTL. RH COM & OMNI ANTENNAS -RADIO COOLING	3930178-14 3940148-2 3960142-6 3910115-2 3970152 3970137-2 3970139-1 3960139-1 3950136-6 3950136 3930216	0.1 0.5 0.5 1.5 0.3 0.3 0.1 0.1 0.1 1.7 1.5	22.0 -250.6 193.4 12.7 14.7 18.5 14.6 194.7 6.0
H37-A	COM. ANTENNA & NAV COUPLER KIT (REQUIRED FOR & AVAILABLE ONLY WITH SECOND NAV/COM) -2ND NAV/COM INSTL. KIT -LH VHF COM ANIENNA INSTL. -NAV ANTENNA COUPLER INSTALLATION -CABLE INSTL. COM ANTENNA -ANTENNA ADAPTOR REMOVED	3910185-12 3930186-7 3960113-1 3960111-8 3950136-29 3960139-1	1.0* 0.2 0.5 0.3 0.3 -0.1	39.3* 14.6 63.4 1.6 22.0
H43-A-1	NAV-O-MATIC 200A PARTIAL INSTL (NOT AVAIL- ABLE WITH FACTORY INSTALLED NAV/COM'S) -CONTROLLER-AMPLIFIER -TURN COORDINATOR (D88-0-1)(NET CHANGE) -WING SERVO INSTALLATION	3910154-111 43610-1202 42320-0028 0700215	8.8* 1.1 0.3 5.4	49.4* 13.5 15.3 69.8
H43-A-2	NAV-O-MATIC 300A PARTIAL INSTL (NOT AVAIL- ABLE WITH FACTORY INSTALLED NAV/COM'S) -CONTROLLER-AMPLIFIER (C-395A) -CYRO INSTALLATION, NET CHANGE (ITEM D64-0-1 REPLACES ITEM D64-S) -TURN COORDINATOR (D88-0-1)(NET CHANGE) -WING SERVO INSTALLATION	3910154-122 42660-1202 0701036-1 42320-0028 0700215	9.5* 1.4 0.4 0.3 5.4	47.8* 13.5 10.5 15.5 69.8
H43-A-3	NAV-O-MATIC 400E PARTIAL INSTL -CONTROLLER -PITCH ACTUATOR ASSEMBLY -ROLL ACTUATOR ASSEMBLY -ELEVATOR TRIM ACTUATOR ASSEMBLY -HEAVY DUTY BATTERY NET CHANGE	3910154-140 37260-1128 45850-3913 45939-4601 -- --	39.0* 1.5 4.2 4.2 2.3 2.0	114.0* 15.0 157.4 68.0 220.0 150.0

SECTION 6
WEIGHT & BALANCE/
EQUIPMENT LIST

CESSNA
MODEL R182

ITEM NO	EQUIPMENT LIST DESCRIPTION	REF DRAWING	WT LBS	ARM INS
	-COMPUTER-AMPLIFIER -MISC ITEMS INCL. CABLES & HARDWARE	42680-0009	5.8 19.0	151.4 96.5
H46-A	ADF ANTI PRECIP SENSE ANTENNA	3960116-6	0.8	141.8
H55-A-1	HEADSET-MICROPHONE, LIGHT WEIGHT	C596553-01C1	0.3	14.0
H55-A-2	HEADSET-MICROPHONE, PADDED (STOWED)	C596531-0101	1.1	14.0
H56-A	HEADSET FOR SEATED, REAR SEAT (2)	C596532-0101	2.2	50.0
H61-R	CABIN SPEAKER (REQUIRED AS PART OF STALL WARNING SYS.)	C596510-0101	1.9	45.1
H64-A	NAV/COM PARTIAL INSTL A (FOR EXPORT ONLY) -RADIO COILING PARTIAL ASSEMBLY -OMNI ANTENNA CABLE ASSEMBLY -COM ANTENNA CABLE INSTL RH SIDE -COM ANTENNA INSTL, RH -OMNI ANTENNA INSTL -HEADPHONE INSTALLATION -MICROPHONE INSTALLATION	3910206-13 3930216 3950136-5 3950136-28 3960113-2 3960142-6 3970137-2 3970139-1	4.7* 1.5 1.1 0.6 0.5 0.6 0.3	72.8* 6.0 127.4 22.0 63.4 250.6 14.6 18.5
H67-A	NAV/COM PARTIAL B INSTL FOR DUAL NAV/COMS (FOR EXPORT AIRCRAFT ONLY) -PARTIAL OPTION A -COM ANTENNA CABLE INSTL LH SIDE -ANTENNA COUPLER ASSEMBLY FOR NAV. -COM ANTENNA INSTL LH SIDE	3910206-14 3910206-13 3950136-29 3960111-8 3960113-1	6.0* 4.7 0.6 0.2 0.5	64.7* 72.8 22.0 1.6 63.4
H70-A	REMOTE TRANSPONDER IDENT SWITCH & WIRING J. SPECIAL OPTION PACKAGES	3910205	0.2	17.0
J01-A	SKYLINE RG II KIT -CG7-A GROUND SERVICE RECEP TACLE -C19-C HEATED PITOT & STILL WARNING -C31-A COURTESY ENTRANCE LIGHTS (2) -C40-A NAV LIGHT DETECTORS (2)	2260001 2270017-1 2770724-7 6700615-11 0701013-1 6-2	51.9* 2.8 0.5 0.5 NEGL	50.7* 136.5 26.5 61.7 1

CESSNA
MODEL R182

SECTION 6
WEIGHT & BALANCE/
EQUIPMENT LIST

ITEM NO	EQUIPMENT LIST DESCRIPTION	REF DRAWING	WT LBS	ARM INS
	-C43-A FLASHING BEACON LIGHT -D01-B TRUE AIRSPEED IND. (NET CHANGE) -D04-A STATIC ALTERNATE AIR SOURCE -D49-A E.G.P. INDICATOR -E85-A DUAL CONTROLS -G16-A STALIC DISCHARGERS (SET OF 10) -H01-A-1 CESSNA 300 ADF (R-548E) -H02-A-1 CESSNA 300 TRANSPONDER RT-359A -H22-A-1 NAV/COM, 1ST UNIT (RT-385A) -H28-A-1 EMERGENCY LOCATOR TRANSMITTER -H31-A-1 CESSNA 200A AUTOPILOT -H34-A BASIC AVIONICS PACKAGE	0761042-3 1201108-19 0701028-1 0750609-3 0760101-3 1201131-20 3910159-20 3910127-28 3910183-20 0470419-27 3910162-24 3910186-14	1.8 0.3 0.5 0.7 0.7 0.4 0.4 3.9 3.0 3.5 3.8 7.2	208.6 14.4 14.2 14.1 130.4 22.4 16.1 12.8 12.2 149.4 53.7
J04-A	NAV-PAC (SKYLANE RG II ONLY) (NET CHANGE) -H07-A 400 GLIDESLOPE (R-443B) -H13-A 400 MARKER BEACON (R-402A) -H23-A-1 2ND UNIT 300 NAV/COM, RT-385A -H37-A ANTENNA & COUPLER KIT	3910157-11 3910164-26 3910183-20 3910185-12	16.9* 5.1 2.8 8.0 1.0	56.2* 107.2 93.5 12.8 39.3

SECTION 7

AIRPLANE & SYSTEMS DESCRIPTIONS

TABLE OF CONTENTS

	Page
Introduction	7-3
Airframe	7-3
Flight Controls	7-8
Trim Systems	7-8
Instrument Panel	7-8
Ground Control	7-9
Wing Flap System	7-10
Landing Gear System	7-11
Landing Gear Lever	7-11
Landing Gear Position Indicator Lights	7-12
Landing Gear Operation	7-12
Emergency Hand Pump	7-12
Landing Gear Warning System	7-13
Baggage Compartment	7-13
Seats	7-13
Seat Belts And Shoulder Harnesses	7-14
Seat Belts	7-15
Shoulder Harnesses	7-15
Integrated Seat Belt/Shoulder Harnesses With Inertia Reels	7-17
Entrance Doors And Cabin Windows	7-17
Control Locks	7-18
Engine	7-18
Engine Controls	7-19
Engine Instruments	7-19
New Engine Break-In And Operation	7-20
Engine Oil System	7-20
Ignition-Starter System	7-21
Air Induction System	7-22
Exhaust System	7-22
Carburetor And Priming System	7-22
Cooling System	7-23
Propeller	7-23
Fuel System	7-24

TABLE OF CONTENTS (Continued)

	Page
Hydraulic System	7-27
Brake System	7-29
Electrical System	7-29
Master Switch	7-31
Avionics Power Switch	7-31
Ammeter	7-31
Alternator Control Unit and Low-Voltage Warning Light	7-32
Circuit Breakers And Fuses	7-32
Ground Service Plug Receptacle	7-33
Lighting Systems	7-33
Exterior Lighting	7-33
Interior Lighting	7-33
Cabin Heating, Ventilating And Defrosting System	7-35
Pitot-Static System And Instruments	7-37
Airspeed Indicator	7-38
Vertical Speed Indicator	7-38
Altimeter	7-38
Vacuum System And Instruments	7-38
Attitude Indicator	7-40
Directional Indicator	7-40
Suction Gage	7-40
Stall Warning System	7-40
Avionics Support Equipment	7-41
Avionics Cooling Fan	7-41
Microphone - Headset Installations	7-41
Static Dischargers	7-42

INTRODUCTION

This section provides description and operation of the airplane and its systems. Some equipment described herein is optional and may not be installed in the airplane. Refer to Section 9, Supplements, for details of other optional systems and equipment.

AIRFRAME

The airplane is an all-metal, four-place, high-wing, single-engine airplane equipped with retractable tricycle landing gear and designed for general utility purposes.

The construction of the fuselage is a conventional formed sheet metal bulkhead, stringer, and skin design referred to as semimonocoque. Major items of structure are the front and rear carry-through spars to which the wings are attached, a bulkhead with attaching plates at the base of the forward doorposts for the lower attachment of the wing struts, and the forgings and structure for the retractable main landing gear in the lower aft portion of the fuselage center section. Four engine mount stringers are also attached to the forward doorposts and extend forward to the firewall. A tunnel incorporated into the fuselage structure below the engine, in front of the firewall, is required for the forward retracting nose wheel.

The externally braced wings, containing the fuel tanks, are constructed of a front and rear spar with formed sheet metal ribs, doublers, and stringers. The entire structure is covered with aluminum skin. The front spars are equipped with wing-to-fuselage and wing-to-strut attach fittings. The aft spars are equipped with wing-to-fuselage attach fittings, and are partial-span spars. Conventional hinged ailerons and single-slot type flaps are attached to the trailing edge of the wings. The ailerons are constructed of a forward spar containing balance weights, formed sheet metal ribs and "V" type corrugated aluminum skin joined together at the trailing edge. The flaps are constructed basically the same as the ailerons, with the exception of balance weights and the addition of a formed sheet metal leading edge section.

The empennage (tail assembly) consists of a conventional vertical stabilizer, rudder, horizontal stabilizer, and elevator. The vertical stabilizer consists of a forward and aft spar, formed sheet metal ribs and reinforcements, four skin panels, formed leading edge skins, and a dorsal. The rudder is constructed of a forward and aft spar, formed sheet metal ribs and reinforcements, and a wrap-around skin panel. The top of the rudder incorporates a leading edge extension which contains a balance weight. The horizontal stabilizer is constructed of a forward and aft spar, ribs and

AILERON CONTROL SYSTEM

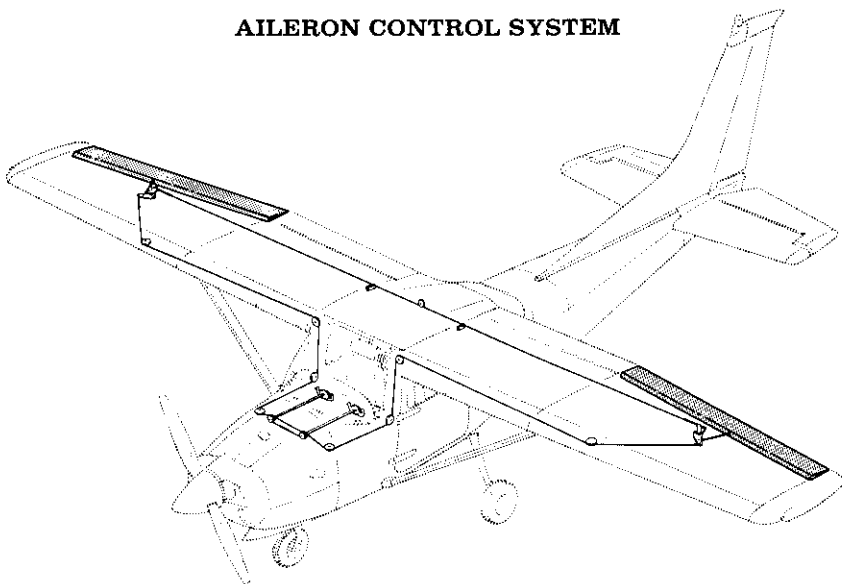

RUDDER AND RUDDER TRIM CONTROL SYSTEMS

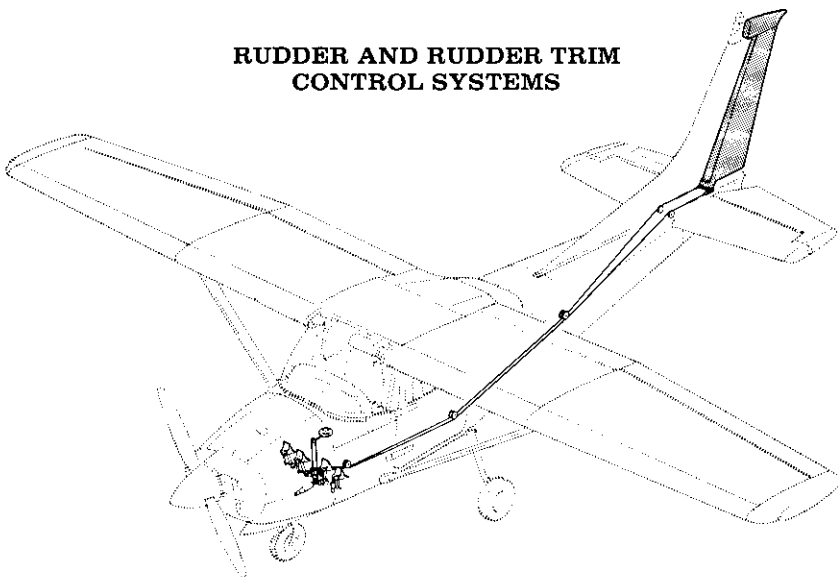
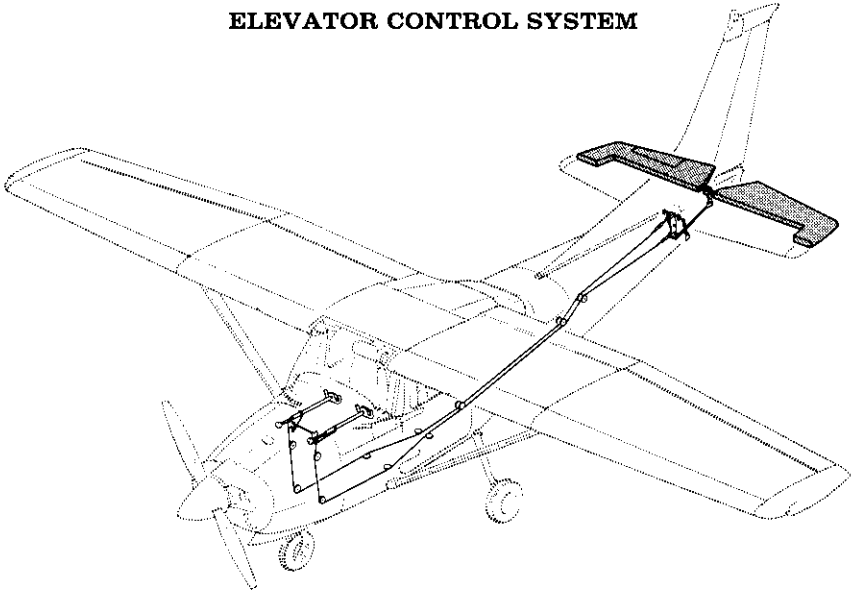

Figure 7-1. Flight Control and Trim Systems (Sheet 1 of 2)

ELEVATOR CONTROL SYSTEM



ELEVATOR TRIM CONTROL SYSTEM

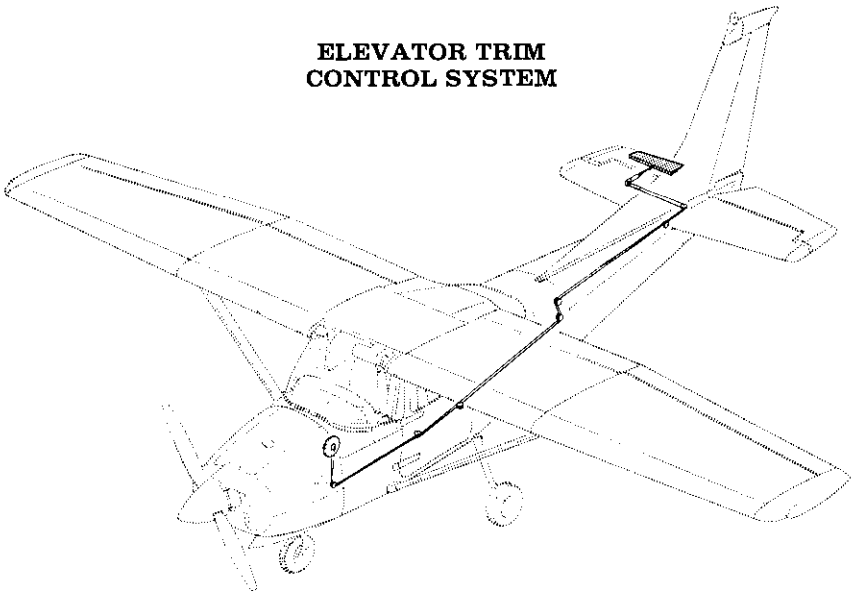

Figure 7-1. Flight Control and Trim Systems (Sheet 2 of 2)

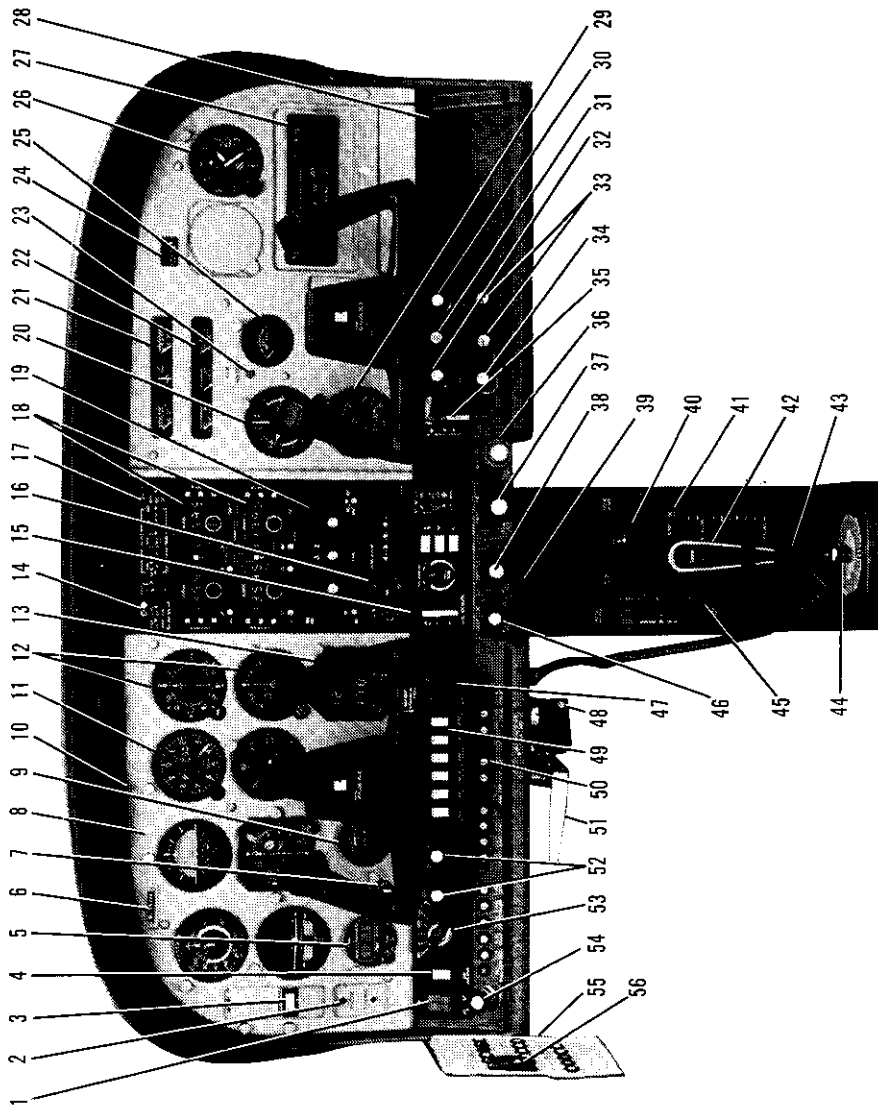

Figure 7-2. Instrument Panel (Sheet 1 of 2)

- | | |
|--|--|
| 1. Master Switch | 29. Tachometer |
| 2. Phone and Auxiliary Mike Jacks | 30. Defroster Control |
| 3. Pitot Heat Switch | 31. Cabin Air Control |
| 4. Auxiliary Fuel Pump Switch | 32. Cabin Heat Control |
| 5. Digital Clock | 33. Air Conditioning System Controls |
| 6. Airplane Registration Number | 34. Lighter |
| 7. Suction Gage | 35. Wing Flap Switch and Position Indicator |
| 8. Flight Instrument Group | 36. Mixture Control |
| 9. Carburetor Air Temperature Gage | 37. Propeller Control |
| 10. Map Light and Switch | 38. Throttle (With Friction Lock) |
| 11. Encoding Altimeter | 39. Control Pedestal Light |
| 12. ADF Bearing and NAV 2 Course Deviation Indicators | 40. Rudder Trim Control Wheel and Position Indicator |
| 13. DME | 41. Cowl Flap Control Lever |
| 14. Marker Beacon Indicator Lights and Switches | 42. Microphone |
| 15. Autopilot Control Unit | 43. Fuel Selector Light |
| 16. Transponder | 44. Fuel Selector Valve Handle |
| 17. Audio Control Panel | 45. Elevator Trim Control Wheel and Position Indicator |
| 18. NAV/COM Radios | 46. Carburetor Heat Control |
| 19. ADF Radio | 47. Landing Gear Lever and Position Indicator Lights |
| 20. Manifold Pressure Gage/
Fuel Pressure Gage | 48. Static Pressure Alternate Source Valve |
| 21. Fuel Quantity Indicators and Ammeter | 49. Electrical Switches |
| 22. Cylinder Head Temperature, Oil Temperature, and Oil Pressure Gages | 50. Circuit Breakers |
| 23. Low-Voltage Warning Light | 51. Parking Brake Handle |
| 24. Flight Hour Recorder | 52. Interior Lighting Controls |
| 25. Economy Mixture Indicator (EGT) | 53. Ignition Switch |
| 26. Secondary Altimeter | 54. Primer |
| 27. AM/FM Cassette Stereo Entertainmnet Center | 55. Sidewall Circuit Breaker Panel |
| 28. Map Compartment | 56. Avionics Power Switch |

Figure 7-2. Instrument Panel (Sheet 2 of 2)

stiffeners, center upper and lower skin panels, and two left and two right wrap-around skin panels which also form the leading edges. The horizontal stabilizer also contains the elevator trim tab actuator. Construction of the elevator consists of formed leading edge skins, a forward spar, ribs, torque tube and bellcrank, left upper and lower "V" type corrugated skins, and right upper and lower "V" type corrugated skins incorporating a trailing edge cut-out for the trim tab. The elevator trim tab consists of a spar and upper and lower "V" type corrugated skins. Both elevator tip leading edge extensions incorporate balance weights.

FLIGHT CONTROLS

The airplane's flight control system (see figure 7-1) consists of conventional aileron, rudder, and elevator control surfaces. The control surfaces are manually operated through mechanical linkage using a control wheel for the ailerons and elevator, and rudder/brake pedals for the rudder. The elevator control system is equipped with downsprings which provide improved stability in flight.

Extensions are available for the rudder/brake pedals. They consist of a rudder pedal face, two spacers and two spring clips. To install an extension, place the clip on the bottom of the extension under the bottom of the rudder pedal and snap the top clip over the top of the rudder pedal. Check that the extension is firmly in place. To remove the extensions, reverse the above procedures.

TRIM SYSTEMS

Manually-operated rudder and elevator trim is provided (see figure 7-1). Rudder trimming is accomplished through a bungee connected to the rudder control system and a trim control wheel mounted on the control pedestal. Rudder trimming is accomplished by rotating the horizontally mounted trim control wheel either left or right to the desired trim position. Rotating the trim wheel to the right will trim nose-right; conversely, rotating it to the left will trim nose-left. Elevator trimming is accomplished through the elevator trim tab by utilizing the vertically mounted trim control wheel. Forward rotation of the trim wheel will trim nose-down; conversely, aft rotation will trim nose-up. The airplane may also be equipped with an electric elevator trim system. For details concerning this system, refer to Section 9, Supplements.

INSTRUMENT PANEL

The instrument panel (see figure 7-2) is designed around the basic "T" configuration. The gyros are located immediately in front of the pilot, and

arranged vertically. The airspeed indicator and altimeter are located to the left and right of the gyros, respectively. The remainder of the flight instruments are located around the basic "T". The suction gage and carburetor air temperature gage are located below the flight instruments, and to the left of the pilot's control column. Avionics equipment is stacked approximately on the centerline of the panel, with the right side of the panel containing the manifold pressure/fuel pressure gage, low-voltage warning light, tachometer, map compartment, and space for additional instruments and avionics equipment. The engine instrument cluster and fuel quantity indicators are to the right side of the avionics stack near the top of the panel. A switch and control panel, at the lower edge of the instrument panel, contains most of the switches, controls, and circuit breakers necessary to operate the airplane. The left side of the panel contains the master switch, engine primer, auxiliary fuel pump switch, ignition switch, light intensity controls, electrical switches, circuit breakers, landing gear indicator lights and landing gear lever. The center area contains the carburetor heat control, throttle, propeller control, and mixture control. The right side of the panel contains the wing flap switch and position indicator, cabin heat, cabin air, and defroster controls and the cigar lighter. A pedestal, extending from the switch and control panel to the floorboard, contains the elevator and rudder trim control wheels, cowl flap control lever, and microphone bracket. The fuel selector valve handle is located at the base of the pedestal. A parking brake handle is mounted below the switch and control panel, in front of the pilot. A static pressure alternate source valve may also be installed below the switch and control panel adjacent to the parking brake handle.

For details concerning the instruments, switches, circuit breakers, and controls on this panel, refer in this section to the description of the systems to which these items are related.

GROUND CONTROL

Effective ground control while taxiing is accomplished through nose wheel steering by using the rudder pedals; left rudder pedal to steer left and right rudder pedal to steer right. When a rudder pedal is depressed, a spring-loaded steering bungee (which is connected to the nose gear and to the rudder bars) will turn the nose wheel through an arc of approximately 15° each side of center. By applying either left or right brake, the degree of turn may be increased up to 30° each side of center.

Moving the airplane by hand is most easily accomplished by attaching a tow bar to the nose gear strut. If a tow bar is not available, or pushing is required, use the wing struts as push points. Do not use the vertical or horizontal surfaces to move the airplane. If the airplane is to be towed by

vehicle, never turn the nose wheel more than 30° either side of center or structural damage to the nose gear could result.

The minimum turning radius of the airplane, using differential braking and nose wheel steering during taxi, is approximately 27 feet 5 inches. To obtain a minimum radius turn during ground handling, the airplane may be rotated around either main landing gear by pressing down on a tailcone bulkhead just forward of the horizontal stabilizer to raise the nose wheel off the ground.

WING FLAP SYSTEM

The single-slot type wing flaps (see figure 7-3) are extended or retracted by positioning the wing flap switch lever on the right side of the switch and control panel to the desired flap deflection position. The switch lever is moved up or down in a slotted panel that provides mechanical stops at the 10° and 20° positions. For flap settings greater than 10°, move the switch lever to the right to clear the stop and position it as desired. A scale and pointer on the left side of the switch lever indicates flap travel in degrees. The wing flap system circuit is protected by a 10-amp "push-to-

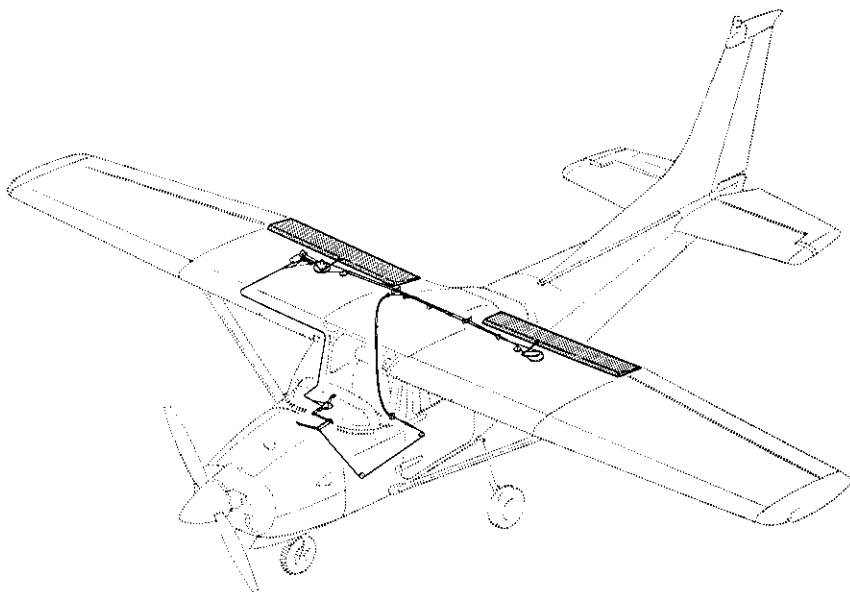

Figure 7-3. Wing Flap System

reset" type circuit breaker, labeled FLAP, on the left side of the switch and control panel.

A gear warning interconnect switch is incorporated in the flap system, and sounds a warning horn when the flaps are extended beyond 25° with the landing gear retracted.

LANDING GEAR SYSTEM

The landing gear is a retractable, tricycle type with a steerable nose wheel and two main wheels. Shock absorption is provided by the tubular spring-steel main landing gear struts and the air/oil nose gear shock strut. Each main gear wheel is equipped with a hydraulically actuated single-disc brake on the inboard side of each wheel.

The landing gear extension, retraction, and main gear down lock operation is accomplished by hydraulic actuators powered by an electrically-driven hydraulic power pack (see figure 7-7). The power pack is located aft of the firewall between the pilot's and copilot's rudder pedals. The hydraulic system fluid level may be checked by utilizing the dipstick/filler cap located on the top right side of the power pack adjacent to the motor mounting flange. The system should be checked at 25-hour intervals. If the fluid level is at or below the ADD line on the dipstick, hydraulic fluid (MIL-H-5606) should be added to bring the level to the top of the dipstick/filler cap opening. A normal operating pressure of 1000 PSI to 1500 PSI is automatically maintained in the landing gear system, and is sufficient to provide a positive up pressure on the main landing gear. The nose gear incorporates an over-center mechanical linkage which provides a positive mechanical up and down lock. Mechanically-actuated wheel well doors are provided for the nose gear. The doors open when the nose gear extends, and close when it retracts.

Power pack operation is started and stopped by a pressure switch, and hydraulic pressure is directed by the landing gear lever. Two position indicator lights are provided to show landing gear position. The landing gear system is also equipped with a nose gear safety (squat) switch, an emergency extension hand pump, and a gear-up warning system.

LANDING GEAR LEVER

The landing gear lever is located on the switch and control panel to the right of the electrical switches. The lever has two positions, labeled GEAR UP and GEAR DOWN, which give a mechanical indication of the gear position selected. From either position, the lever must be pulled out to clear a detent before it can be repositioned; operation of the landing gear

system will not begin until the lever has been repositioned. After the lever has been repositioned, it directs hydraulic pressure within the system to actuate the gear to the selected position.

LANDING GEAR POSITION INDICATOR LIGHTS

Two position indicator lights, adjacent to the landing gear control lever, indicate that the gear is either up or down and locked. Both the gear-up (amber) and gear-down (green) lights are the press-to-test type, incorporating dimming shutters for night operation. If an indicator light bulb should burn out, it can be replaced in flight with the bulb from the remaining indicator light.

LANDING GEAR OPERATION

To retract or extend the landing gear, pull out on the gear lever and move it to the desired position. After the lever is positioned, the power pack will create pressure in the system and actuate the landing gear to the selected position. During a normal cycle, the gear retracts fully or extends and locks, limit switches close, and the indicator light comes on (amber for up and green for down) indicating completion of the cycle. After indicator light illumination, the power pack will continue to run until the fluid pressure reaches 1500 PSI, opens the pressure switch, and turns the power pack off. Whenever fluid pressure in the system drops below 1000 PSI, the pressure switch will close and start power pack operation, except when the nose gear safety (squat) switch is open. During cruising flight with the landing gear retracted, automatic cycling on of the hydraulic pump motor to restore system pressure bleed down may normally occur up to twice per hour. More frequent cycling is an indication of abnormal pressure loss and cause of this condition should be investigated.

The safety (squat) switch, actuated by the nose gear, electrically prevents inadvertent retraction whenever the nose gear strut is compressed by the weight of the airplane. When the nose gear is lifted off the runway during takeoff, the squat switch will close, which may cause the power pack to operate for 1 to 2 seconds and return system pressure to 1500 PSI in the event pressure has dropped below 1000 PSI. A "pull-off" type circuit breaker is also provided in the system as a maintenance safety feature. With the circuit breaker pulled out, landing gear operation by the gear pump motor is prevented. After maintenance is completed, and prior to flight, the circuit breaker should be pushed back in.

EMERGENCY HAND PUMP

A hand-operated hydraulic pump, located between the front seats, is provided for manual extension of the landing gear in the event of a hydraulic system failure. The landing gear cannot be retracted with the

hand pump. To utilize the pump, extend the handle forward, and pump vertically. For complete emergency procedures, refer to Section 3.

LANDING GEAR WARNING SYSTEM

The airplane is equipped with a landing gear warning system designed to help prevent the pilot from inadvertently making a wheels-up landing. The system consists of a throttle actuated switch which is electrically connected to a dual warning unit. The warning unit is connected to the airplane speaker.

When the throttle is retarded below approximately 12 inches of manifold pressure at low altitude (master switch on), the throttle linkage will actuate a switch which is electrically connected to the gear warning portion of a dual warning unit. If the landing gear is retracted (or not down and locked), an intermittent tone will be heard on the airplane speaker. An interconnect switch in the wing flap system also sounds the horn when the wing flaps are extended beyond 25° with the landing gear retracted.

BAGGAGE COMPARTMENT

The baggage compartment consists of the area from the back of the rear passenger seats to the aft cabin bulkhead. A baggage shelf, above the wheel well, extends aft from the aft cabin bulkhead. Access to the baggage compartment and the shelf is gained through a lockable baggage door on the left side of the airplane, or from within the airplane cabin. A baggage net with six tie-down straps is provided for securing baggage, and is attached by tying the straps to tie-down rings provided in the airplane. For further information on baggage tie-down, refer to Section 6. When loading the airplane, children should not be placed or permitted in the baggage compartment, and any material that may be hazardous to the airplane or occupants should not be placed anywhere in the airplane. For baggage area and door dimensions, refer to Section 6.

SEATS

The seating arrangement consists of two individually adjustable four-way or six-way seats for the pilot and front seat passenger, and a split-backed fixed seat for the rear seat passengers. A child's seat (if installed) is located at the aft cabin bulkhead behind the rear seat.

The four-way seats may be moved forward or aft, and the seat back angle adjusted to any comfortable angle. To position either seat, lift the

tubular handle under the center of the seat, slide the seat into position, release the handle, and check that the seat is locked in place. The seat back angle is controlled by a cylinder lock release button which is spring-loaded to the locked position. The release button is located on the inboard side, below the forward corner of the seat cushion. To adjust the angle of the seat back, push up on the release button, position the seat back to the desired angle and release the button. When the seat is not occupied, the seat back will fold forward whenever the release button is pushed up.

The six-way seats may be moved forward or aft, and are infinitely adjustable for height and seat back angle. To position the seat, lift the tubular handle under the center of the seat bottom, slide the seat into position, release the handle, and check that the seat is locked in place. Raise or lower the seat by rotating the large crank under the front inboard corner of either seat. The seat back is adjusted by rotating the small crank under the front outboard corner of either seat. The seat bottom angle will change as the seat back angle changes, providing proper support. The seat backs will also fold full forward.

The rear passengers' seat consists of a fixed one-piece seat bottom with individually adjustable seat backs. The seat backs are adjusted by cylinder lock release buttons, recessed into skirts located below the seat frame at the outboard ends of the seat. To adjust a seat back, push up on the adjacent cylinder lock release button, which is spring-loaded to the locked position, recline the seat back to the desired position and release the button. When the seat is not occupied, the seat backs will automatically fold forward whenever the cylinder lock release button is pushed up.

A child's seat may be installed aft of the rear passengers' seat, and is held in place by two brackets mounted on the floorboard. The seat is designed to swing upward into a stowed position against the aft cabin bulkhead when not in use. To stow the seat, rotate the seat bottom up and aft as far as it will go. When not in use, the seat should be kept in the stowed position.

Headrests are available for any of the seat configurations except the child's seat. To adjust the headrest, apply enough pressure to it to raise or lower it to the desired level. The headrest may be removed at any time by raising it until it disengages from the top of the seat back.

SEAT BELTS AND SHOULDER HARNESSSES

All seat positions are equipped with seat belts (see figure 7-4). The pilot's and front passenger's seats are also equipped with separate shoulder harnesses; separate shoulder harnesses are also available for the rear seat positions. Integrated seat belt/shoulder harnesses with inertia

reels can be furnished for the pilot's and front passenger's seat positions if desired.

SEAT BELTS

The seat belts used with the pilot's and front passenger's seats, and the child's seat (if installed), are attached to fittings on the floorboard. The buckle half is inboard of each seat and the link half is outboard of each seat. The belts for the rear seat are attached to the seat frame, with the link halves on the left and right sides of the seat bottom, and the buckles at the center of the seat bottom.

To use the seat belts for the front seats, position the seat as desired, and then lengthen the link half of the belt as needed by grasping the sides of the link and pulling against the belt. Insert and lock the belt link into the buckle. Tighten the belt to a snug fit. Seat belts for the rear seat, and the child's seat, are used in the same manner as the belts for the front seats. To release the seat belts, grasp the top of the buckle opposite the link and pull upward.

SHOULDER HARNESSSES

Each front seat shoulder harness is attached to a rear doorpost above the window line and is stowed behind a stowage sheath above the cabin door. To stow the harness, fold it and place it behind the sheath. When rear seat shoulder harnesses are furnished, they are attached adjacent to the lower corners of the aft side windows. Each rear seat harness is stowed behind a stowage sheath above an aft side window. No harness is available for the child's seat.

To use a front or rear seat shoulder harness, fasten and adjust the seat belt first. Lengthen the harness as required by pulling on the connecting link on the end of the harness and the narrow release strap. Snap the connecting link firmly onto the retaining stud on the seat belt link half. Then adjust to length. A properly adjusted harness will permit the occupant to lean forward enough to sit completely erect, but prevent excessive forward movement and contact with objects during sudden deceleration. Also, the pilot will want the freedom to reach all controls easily.

Removing the shoulder harness is accomplished by pulling upward on the narrow release strap, and removing the harness connecting link from the stud on the seat belt link. In an emergency, the shoulder harness may be removed by releasing the seat belt first and allowing the harness, still attached to the link half of the seat belt, to drop to the side of the seat.

STANDARD SHOULDER
 HARNESS

- NARROW RELEASE STRAP
 (Pull up when lengthening
 harness)
- FREE END OF HARNESS
 (Pull down to tighten)
- SHOULDER HARNESS
 CONNECTING LINK
 (Snap onto retaining stud on
 seat belt link to attach harness)
- SEAT BELT BUCKLE HALF
 (Non adjustable)

(PILOT'S SEAT SHOWN)

- SEAT BELT LINK HALF
 AND SHOULDER HARNESS
 RETAINING STUD
- FREE END OF SEAT BELT
 (Pull to tighten)

SEAT BELT/SHOULDER
 HARNESS WITH INERTIA
 REEL

- SEAT BELT/SHOULDER HARNESS
 ADJUSTABLE LINK
 (Position link just below shoulder
 level; pull link and harness down-
 ward to connect to seat belt buckle)

- SEAT BELT BUCKLE
 (Non adjustable)

Figure 7-4. Seat Belts and Shoulder Harnesses

INTEGRATED SEAT BELT/SHOULDER HARNESSSES WITH INERTIA REELS

Integrated seat belt/shoulder harnesses with inertia reels are available for the pilot and front seat passenger. The seat belt/shoulder harnesses extend from inertia reels located in the cabin top structure, through slots in the overhead console marked PILOT and COPILOT, to attach points inboard of the two front seats. A separate seat belt half and buckle is located outboard of the seats. Inertia reels allow complete freedom of body movement. However, in the event of a sudden deceleration, they will lock automatically to protect the occupants.

To use the seat belt/shoulder harness, position the adjustable metal link on the harness at about shoulder level, pull the link and harness downward, and insert the link in the seat belt buckle. Adjust belt tension across the lap by pulling upward on the shoulder harness. Removal is accomplished by releasing the seat belt buckle, which will allow the inertia reel to pull the harness inboard of the seat.

ENTRANCE DOORS AND CABIN WINDOWS

Entry to, and exit from the airplane is accomplished through either of two entry doors, one on each side of the cabin at the front seat positions (refer to Section 6 for cabin and cabin door dimensions). The doors incorporate a recessed exterior door handle, a conventional interior door handle, a key-operated door lock (left door only), a door stop mechanism, and an openable window in the left door. An openable right door window is also available.

To open the doors from outside the airplane, utilize the recessed door handle near the aft edge of each door. Grasp the forward end of the handle and pull outboard. To close or open the doors from inside the airplane, use the combination door handle and arm rest. The inside door handle has three positions and a placard at its base which reads OPEN, CLOSE, and LOCK. The handle is spring-loaded to the CLOSE (up) position. When the door has been pulled shut and latched, lock it by rotating the door handle forward to the LOCK position (flush with the arm rest). When the handle is rotated to the LOCK position, an over-center action will hold it in that position. Both cabin doors should be locked prior to flight, and should not be opened intentionally during flight.

NOTE

Accidental opening of a cabin door in flight due to improper closing does not constitute a need to land the airplane. The best procedure is to set up the airplane in a

trimmed condition at approximately 80 KIAS, open a window, momentarily shove the door outward slightly, and forcefully close and lock the door.

Exit from the airplane is accomplished by rotating the door handle from the LOCK position, past the CLOSE position, aft to the OPEN position and pushing the door open. To lock the airplane, lock the right cabin door with the inside handle, close the left cabin door, and using the ignition key, lock the door.

The left cabin door is equipped with an openable window which is held in the closed position by a detent equipped latch on the lower edge of the window frame. To open the window, rotate the latch upward. The window is equipped with a spring-loaded retaining arm which will help rotate the window outward and hold it there. An openable window is also available for the right door, and functions in the same manner as the left window. If required, either window may be opened at any speed up to 181 KIAS. The cabin top windows (if installed), rear side windows, and rear window are of the fixed type and cannot be opened.

CONTROL LOCKS

A control lock is provided to lock the aileron and elevator control surfaces to prevent damage to these systems by wind buffeting while the airplane is parked. The lock consists of a shaped steel rod with a red metal flag attached to it. The flag is labeled CONTROL LOCK, REMOVE BEFORE STARTING ENGINE. To install the control lock, align the hole in the right side of the pilot's control wheel shaft with the hole in the right side of the shaft collar on the instrument panel and insert the rod into the aligned holes. Installation of the lock will secure the ailerons in a neutral position and the elevators in a slightly trailing edge down position. Proper installation of the lock will place the red flag over the ignition switch. In areas where high or gusty winds occur, a control surface lock should be installed over the vertical stabilizer and rudder. The control lock and any other type of locking device should be removed prior to starting the engine.

ENGINE

The airplane is powered by a horizontally-opposed, six-cylinder, overhead-valve, air-cooled, carbureted engine with a wet sump oil system. The engine is a Lycoming Model O-540-J3C5D and is rated at 235 horsepower at 2400 RPM. Major accessories include a starter, belt-driven alternator, belt-driven air conditioner compressor (if installed) and propeller governor on the front of the engine and dual magnetos encased in a single drive housing, fuel pump, vacuum pump, and full-flow oil filter on the rear

of the engine.

ENGINE CONTROLS

Engine manifold pressure is controlled by a throttle located on the center area of the switch and control panel. The throttle operates in a conventional manner; in the full forward position, the throttle is open, and in the full aft position, it is closed. A friction lock, which is a round knurled disk, is located at the base of the throttle and is operated by rotating the lock clockwise to increase friction or counterclockwise to decrease it.

The mixture control, mounted near the propeller control, is a red knob with raised points around the circumference and is equipped with a lock button in the end of the knob. The rich position is full forward, and full aft is the idle cut-off position. For small adjustments, the control may be moved forward by rotating the knob clockwise, and aft by rotating the knob counterclockwise. For rapid or large adjustments, the knob may be moved forward or aft by depressing the lock button in the end of the control, and then positioning the control as desired.

ENGINE INSTRUMENTS

Engine operation is monitored by the following instruments: oil pressure gage, oil temperature gage, cylinder head temperature gage, tachometer, manifold pressure gage and fuel pressure gage. An economy mixture (EGT) indicator and carburetor air temperature gage are also available.

The oil pressure gage, located on the right side of the instrument panel, is operated by oil pressure. A direct pressure oil line from the engine delivers oil at engine operating pressure to the oil pressure gage. Gage markings indicate that minimum idling pressure is 25 PSI (red line), the normal operating range is 60 to 90 PSI (green arc), and maximum pressure is 115 PSI (red line).

Oil temperature is indicated by a gage adjacent to the oil pressure gage. The gage is operated by an electrical resistance type temperature sensor which receives power from the airplane electrical system. Gage markings indicate the normal operating range (green arc) which is 100°F (38°C) to 245°F (118°C), and the maximum (red line) which is 245°F (118°C).

The cylinder head temperature gage, below the left fuel quantity indicator, is operated by an electrical-resistance type temperature sensor on the engine which receives power from the airplane electrical system. Gage markings indicate the normal operating range (green arc) which is 200°F (93°C) to 500°F (260°C) and the maximum (red line) which is 500°F (260°C).

The engine-driven mechanical tachometer is located on the lower right side of the instrument panel. The instrument is calibrated in increments of 100 RPM and indicates both engine and propeller speed. An hour meter below the center of the tachometer dial records elapsed engine time in hours and tenths. Instrument markings include a normal operating range (green arc) of 2100 to 2400 RPM, and a maximum (red line) of 2400 RPM.

The manifold pressure gage is the left half of a dual-indicating instrument located on the right side of the instrument panel above the tachometer. The gage is direct reading and indicates induction air manifold pressure in inches of mercury. It has a normal operating range (green arc) of 15 to 23 inches of mercury.

The fuel pressure gage is the right half of the dual-indicating instrument described above and indicates fuel pressure to the carburetor. Gage markings indicate that minimum pressure is 0.5 PSI (red line), normal operating range is 0.5 to 8 PSI (green arc), and maximum pressure is 8 PSI (red line).

An economy mixture (EGT) indicator is available for the airplane and is located on the right side of the instrument panel. A thermocouple probe in the left exhaust stack assembly measures exhaust gas temperature and transmits it to the indicator. The indicator serves as a visual aid to the pilot in adjusting the mixture during climb or cruise as described in Section 4. Exhaust gas temperature varies with fuel-to-air ratio, power, and RPM. However, the difference between the peak EGT and the EGT at the desired mixture setting is essentially constant and this provides a useful leaning aid. The indicator is equipped with a manually positioned reference pointer which is especially useful for leaning during climb.

A carburetor air temperature gage is available for the airplane. Details of this gage are presented in Section 9, Supplements.

NEW ENGINE BREAK-IN AND OPERATION

The engine underwent a run-in at the factory and is ready for the full range of use. It is, however, suggested that cruising be accomplished at a minimum of 75% power until a total of 25 hours has accumulated or oil consumption has stabilized. This will ensure proper seating of the rings.

ENGINE OIL SYSTEM

Oil for engine lubrication and propeller governor operation is supp-

ried from a sump on the bottom of the engine. The capacity of the sump is 8 quarts (one additional quart is contained in the engine oil filter). Oil is drawn from the sump through a filter screen on the end of a pickup tube to the engine-driven oil pump. Oil from the pump passes through an oil pressure screen, full flow oil filter, a pressure relief valve at the rear of the right oil gallery, and a thermostatically controlled remote oil cooler. Oil from the remote cooler is then circulated to the left gallery and propeller governor. The engine parts are then lubricated by oil from the galleries. After lubricating the engine, the oil returns to the sump by gravity. The filter adapter in the full flow oil filter is equipped with a bypass valve which will cause lubricating oil to bypass the filter in the event the filter becomes plugged, or the oil temperature is extremely cold.

An oil dipstick is located at the rear of the engine on the right side, and an oil filler tube is on top of the crankcase near the front of the engine. The dipstick and oil filler are accessible through doors on the engine cowling. The engine should not be operated on less than five quarts of oil. To minimize loss of oil through the breather, fill to seven quarts for normal flights of less than three hours. For extended flight, fill to eight quarts (dipstick indication only). For engine oil grade and specifications, refer to Section 8 of this handbook.

An oil quick-drain valve is installed on the bottom of the oil sump, to provide a quick, clean method of draining the engine oil. To drain the oil, slip a hose over the end of the valve and push upward on the end of the valve until it snaps into the open position. Spring clips will hold the valve open. After draining, use a suitable tool to snap the valve into the extended (closed) position and remove the drain hose.

IGNITION-STARTER SYSTEM

Engine ignition is provided by two engine-driven magnetos encased in a single drive housing, and two spark plugs in each cylinder. The right magneto fires the lower right and upper left spark plugs, and the left magneto fires the lower left and upper right spark plugs. Normal operation is conducted with both magnetos due to the more complete burning of the fuel-air mixture with dual ignition.

Ignition and starter operation is controlled by a rotary type switch located on the left switch and control panel. The switch is labeled clockwise, OFF, R, L, BOTH, and START. The engine should be operated on both magnetos (BOTH position) except for magneto checks. The R and L positions are for checking purposes and emergency use only. When the switch is rotated to the spring-loaded START position (with the master switch in the ON position), the starter contactor is energized and the starter will crank the engine. When the switch is released, it will automati-

cally return to the BOTH position.

AIR INDUCTION SYSTEM

The engine air induction system receives ram air through an intake scoop in the upper left hand engine cowling. The intake scoop is covered by an air filter which removes dust and other foreign matter from the induction air. Airflow passing through the filter enters an airbox. After passing through the airbox, induction air enters the inlet in the carburetor which is below the engine, and is then ducted to the engine cylinders through intake manifold tubes. In the event carburetor ice is encountered or the intake filter becomes blocked, alternate heated air can be obtained from a shroud around the left muffler through a duct to a valve, in the airbox, operated by the carburetor heat control on the instrument panel. Heated air from the muffler shroud is obtained from unfiltered air inside the cowling. Use of full carburetor heat at full throttle will result in a loss of approximately one inch of manifold pressure.

EXHAUST SYSTEM

Exhaust gas from each cylinder passes through riser assemblies to a muffler and tailpipe on each side of the engine. Shrouds are constructed around the outside of the mufflers to form heating chambers. The left muffler supplies heat to the carburetor, and the right muffler supplies heat to the cabin.

CARBURETOR AND PRIMING SYSTEM

The engine is equipped with a side-draft, float-type, fixed jet carburetor mounted below the engine adjacent to the firewall. The carburetor is equipped with an enclosed accelerator pump, an idle cut-off mechanism, and a manual mixture control. Fuel is delivered from the fuel system to the carburetor by gravity flow, the engine-driven fuel pump, and/or auxiliary fuel pump. In the carburetor, fuel is atomized, proportionally mixed with intake air, and delivered to the cylinders through intake manifold tubes. The proportion of atomized fuel to air may be controlled, within limits, by the mixture control located on the lower center portion of the instrument panel.

For easy starting in cold weather, the engine is equipped with a manual primer. The primer is actually a small pump which draws fuel from the fuel strainer when the plunger knob is pulled out, and injects it into the engine intake ports when the knob is pushed back in. The plunger knob is equipped with a lock and, after being pushed full in, must be rotated either left or right until the knob cannot be pulled out.

COOLING SYSTEM

Ram air for engine cooling enters through two intake openings in the front of the engine cowling. The cooling air is directed around the cylinders by baffling and through the remote oil cooler and is then exhausted through cowl flaps on the lower aft edge of the cowling. The cowl flaps are mechanically operated from the cabin by means of a cowl flap lever on the right side of the control pedestal. The pedestal is labeled OPEN, COWL FLAPS, CLOSED. Before starting the engine, and throughout takeoff and high power operation, the cowl flap lever should be placed in the OPEN position for maximum cooling. This is accomplished by moving the lever to the right to clear a detent, then moving the lever up to the OPEN position. Anytime the lever is repositioned, it must first be moved to the right. While in cruise flight, cowl flaps should be adjusted to keep the cylinder head temperature at approximately two-thirds of the normal operating range (green arc). During extended let-downs, the cowl flaps should be completely closed by pushing the cowl flap lever down to the CLOSED position.

A winterization kit is available for the airplane. Details of this kit are presented in Section 9, Supplements.

PROPELLER

The airplane has an all-metal, two-bladed, constant-speed, governor-regulated propeller. A three-bladed propeller is also available. A setting introduced into the governor with the propeller control establishes the propeller speed, and thus the engine speed to be maintained. The governor then controls flow of engine oil, boosted to high pressure by the governing pump, to or from a piston in the propeller hub. Oil pressure acting on the piston twists the blades toward high pitch (low RPM). When oil pressure to the piston in the propeller hub is relieved, centrifugal force, assisted by an internal spring, twists the blades toward low pitch (high RPM).

A control knob on the center area of the switch and control panel is used to set the propeller and control engine RPM as desired for various flight conditions. The knob is labeled PROPELLER, PUSH INCR RPM. When the control knob is pushed in, blade pitch will decrease, giving a higher RPM. When the control knob is pulled out, the blade pitch increases, thereby decreasing RPM. The propeller control knob is equipped with a vernier feature which allows slow or fine RPM adjustments by rotating the knob clockwise to increase RPM, and counterclockwise to decrease it. To make rapid or large adjustments, depress the button on the end of the control knob and reposition the control as desired.

FUEL SYSTEM

The airplane fuel system (see figure 7-5) consists of two vented integral fuel tanks (one in each wing), a four-position selector valve, fuel strainer, manual primer, auxiliary fuel pump, engine-driven fuel pump, and carburetor. Refer to figure 7-6 for fuel quantity data for the system.

Fuel flows by gravity from the two integral wing tanks to a four-position selector valve, labeled BOTH, RIGHT, LEFT, and OFF. With the selector valve in either the BOTH, RIGHT, or LEFT position, fuel flows through a strainer and a bypass in the auxiliary fuel pump (when it is not in operation) to the engine-driven fuel pump, and from the pump to the carburetor. From the carburetor, mixed fuel and air flows to the cylinders through intake manifold tubes. The manual primer draws its fuel from the fuel strainer and injects it into the engine intake ports.

The airplane may be serviced to a reduced fuel capacity to permit heavier cabin loadings by filling each fuel tank to the bottom edge of the fuel filler neck, thus giving a reduced fuel load of 34.5 gallons in each tank (32.5 gallons usable in all flight conditions).

Fuel system venting is essential to system operation. Complete blockage of the venting system will result in a decreasing fuel flow and eventual engine stoppage. Venting consists of an interconnecting vent line between the tanks, and check valve equipped overboard vents in each tank. The overboard vents protrude from the bottom surfaces of the wings behind the wing struts, slightly below the upper attach points of the struts. The fuel filler caps are vacuum vented; the vents will open and allow air to enter the fuel tanks in case the overboard vents become blocked.

Fuel quantity is measured by two float-type fuel quantity transmitters (one in each tank) and indicated by two electrically-operated fuel quantity indicators on the right side of the instrument panel. The fuel quantity indicators are calibrated in gallons (lower scale) and pounds (upper scale). An empty tank is indicated by a red line and the letter E. When an indicator shows an empty tank, approximately 2 gallons remain in a tank as unusable fuel. The indicators cannot be relied upon for accurate readings during skids, slips, or unusual attitudes. If both indicator pointers should rapidly move to a zero reading, check the cylinder head temperature gage for operation. If these gages are not indicating, an electrical malfunction has occurred.

The auxiliary fuel pump switch is located on the left side of the switch and control panel and is a rocker-type switch. It is labeled AUX FUEL PUMP. When the pump is operating, it will maintain fuel pressure to the carburetor. It should be used whenever the indicated fuel pressure falls below 0.5 PSI, but is not required when gravity flow and/or the engine-

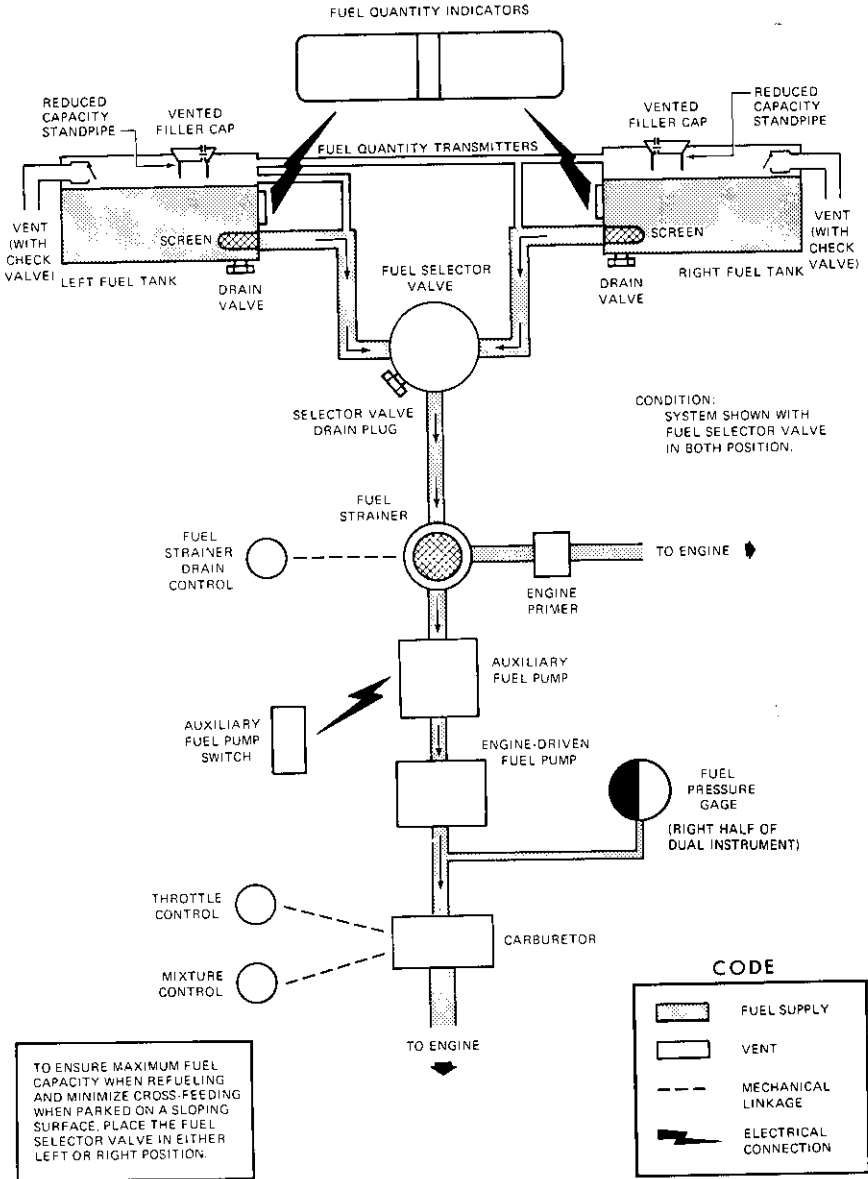

Figure 7-5. Fuel System

FUEL QUANTITY DATA (U.S. GALLONS)				
FUEL TANKS	FUEL LEVEL (QUANTITY EACH TANK)	TOTAL FUEL	TOTAL UNUSABLE	TOTAL USABLE ALL FLIGHT CONDITIONS
STANDARD	FULL (46)	92	4	88
STANDARD	REDUCED (34.5)	69	4	65

Figure 7-6. Fuel Quantity Data

driven fuel pump can maintain indicated pressures above 0.5 PSI.

The fuel selector valve should be in the BOTH position for takeoff, climb, descent, landing, and maneuvers that involve prolonged slips or skids. Operation from either LEFT or RIGHT tank is reserved for level cruising flight only.

NOTE

Unusable fuel is at a minimum due to the design of the fuel system. However, with 1/4 tank or less, prolonged uncoordinated flight such as slips or skids can uncover the fuel tank outlets, causing fuel starvation and engine stoppage. Therefore, with low fuel reserves, do not allow the airplane to remain in uncoordinated flight for periods in excess of one minute.

NOTE

When the fuel selector valve handle is in the BOTH position in cruising flight, unequal fuel flow from each tank may occur if the wings are not maintained exactly level. Resulting wing heaviness can be alleviated gradually by turning the selector valve handle to the tank in the "heavy" wing.

NOTE

It is not practical to measure the time required to consume all of the fuel in one tank, and, after switching to the

opposite tank, expect an equal duration from the remaining fuel. The airspace in both fuel tanks is interconnected by a vent line and, therefore, some sloshing of fuel between tanks can be expected when the tanks are nearly full and the wings are not level.

The fuel system is equipped with drain valves to provide a means for the examination of fuel in the system for contamination and grade. The system should be examined before the first flight of every day and after each refueling, by using the sampler cup provided to drain fuel from the wing tank sumps, and by utilizing the fuel strainer drain under an access panel on the left side of the engine cowling. The fuel tanks should be filled after each flight to prevent condensation.

HYDRAULIC SYSTEM

Hydraulic power (see figure 7-7) is supplied by an electrically-driven hydraulic power pack located behind the firewall between the pilot's and copilot's rudder pedals. The power pack's only function is to supply hydraulic power for operation of the retractable landing gear. This is accomplished by applying hydraulic pressure to actuator cylinders which extend or retract the gear. The hydraulic system normally operates at 1000 PSI to 1500 PSI, and is protected by relief valves which prevent high pressure damage to the pump and other components in the system. The electrical portion of the power pack is protected by a 30-amp "pull-off" type circuit breaker, labeled GEAR PUMP, on the left switch and control panel.

The hydraulic power pack is turned on by a pressure switch on the power pack when the landing gear lever is placed in either the GEAR UP or GEAR DOWN position. When the lever is placed in the GEAR UP or GEAR DOWN position, it mechanically rotates a selector valve which applies hydraulic pressure in the direction selected. As soon as the landing gear reaches the selected position, a series of electrical switches will illuminate one of two indicator lights on the instrument panel to show gear position and completion of the cycle. After indicator light illumination, hydraulic pressure will continue to build until the power pack pressure switch turns the power pack off.

The hydraulic system includes an emergency hand pump to permit manual extension of the landing gear in the event of hydraulic power pack failure. The hand pump is located on the cabin floor between the front seats.

During normal operations, the landing gear should require from 5 to 7 seconds to fully extend or retract. For malfunctions of the hydraulic and landing gear systems, refer to Section 3 of this handbook.

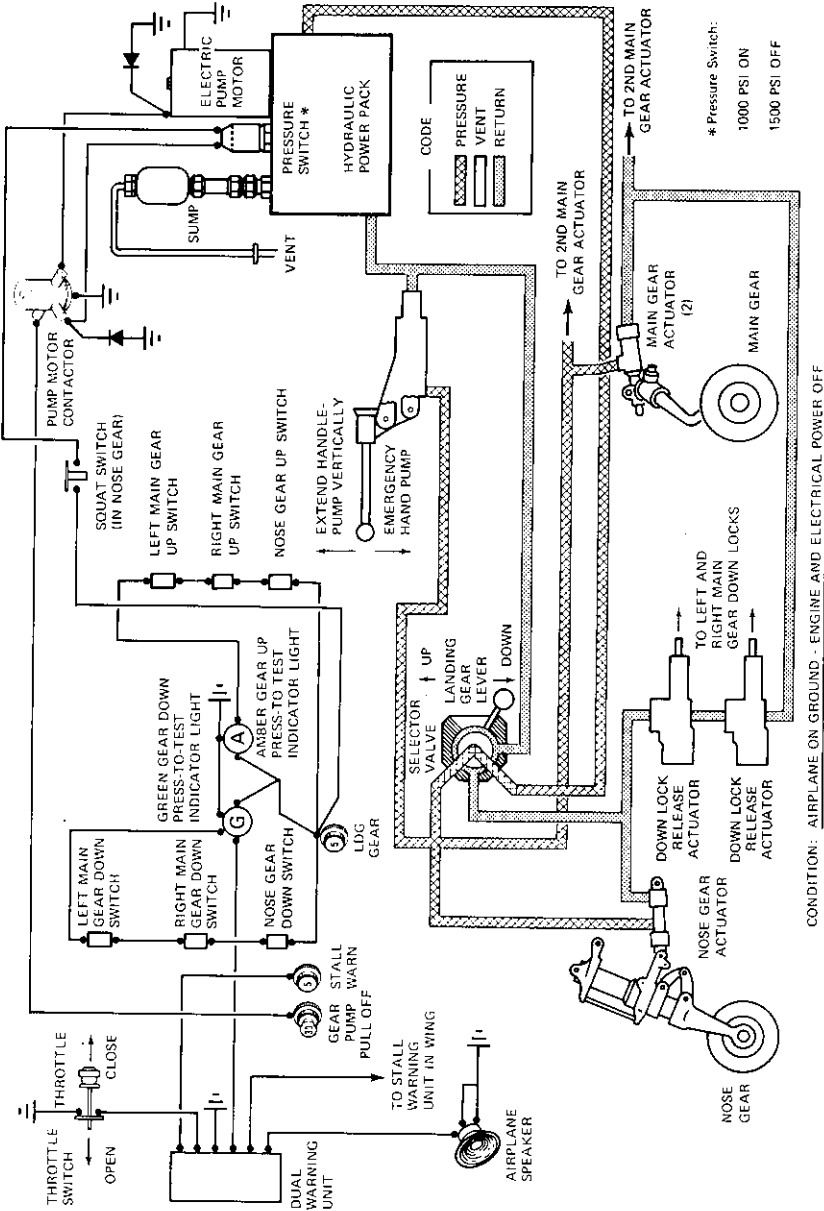

Figure 7-7. Hydraulic System

BRAKE SYSTEM

The airplane has a single-disc, hydraulically-actuated brake on each main landing gear wheel. Each brake is connected, by a hydraulic line, to a master cylinder attached to each of the pilot's rudder pedals. The brakes are operated by applying pressure to the top of either the left (pilot's) or right (copilot's) set of rudder pedals, which are interconnected. When the airplane is parked, both main wheel brakes may be set by utilizing the parking brake which is operated by a handle below the left side of the switch and control panel. To apply the parking brake, set the brakes with the rudder pedals, pull the handle aft, and rotate it 90° down.

For maximum brake life, keep the brake system properly maintained, and minimize brake usage during taxi operations and landings.

Some of the symptoms of impending brake failure are: gradual decrease in braking action after brake application, noisy or dragging brakes, soft or spongy pedals, and excessive travel and weak braking action. If any of these symptoms appear, the brake system is in need of immediate attention. If, during taxi or landing roll, braking action decreases, let up on the pedals and then re-apply the brakes with heavy pressure. If the brakes become spongy or pedal travel increases, pumping the pedals should build braking pressure. If one brake becomes weak or fails, use the other brake sparingly while using opposite rudder, as required, to offset the good brake.

ELECTRICAL SYSTEM

The airplane is equipped with a 28-volt, direct-current electrical system (see figure 7-8). The system uses a battery located aft of the baggage compartment wall as the source of electrical energy and a belt-driven 60-amp alternator (or a 95-amp, if installed) to maintain the battery's state of charge. Power is supplied to most general electrical and all avionics circuits through the primary bus bar and the avionics bus bar, which are interconnected by an avionics power switch. The primary bus is on anytime the master switch is turned on, and is not affected by starter or external power usage. Both bus bars are on anytime the master and avionics power switches are turned on.

CAUTION

Prior to turning the master switch on or off, starting the engine, or applying an external power source, the avionics power switch, labeled AVN PWR, should be turned off to prevent any harmful transient voltage from damaging the avionics equipment.

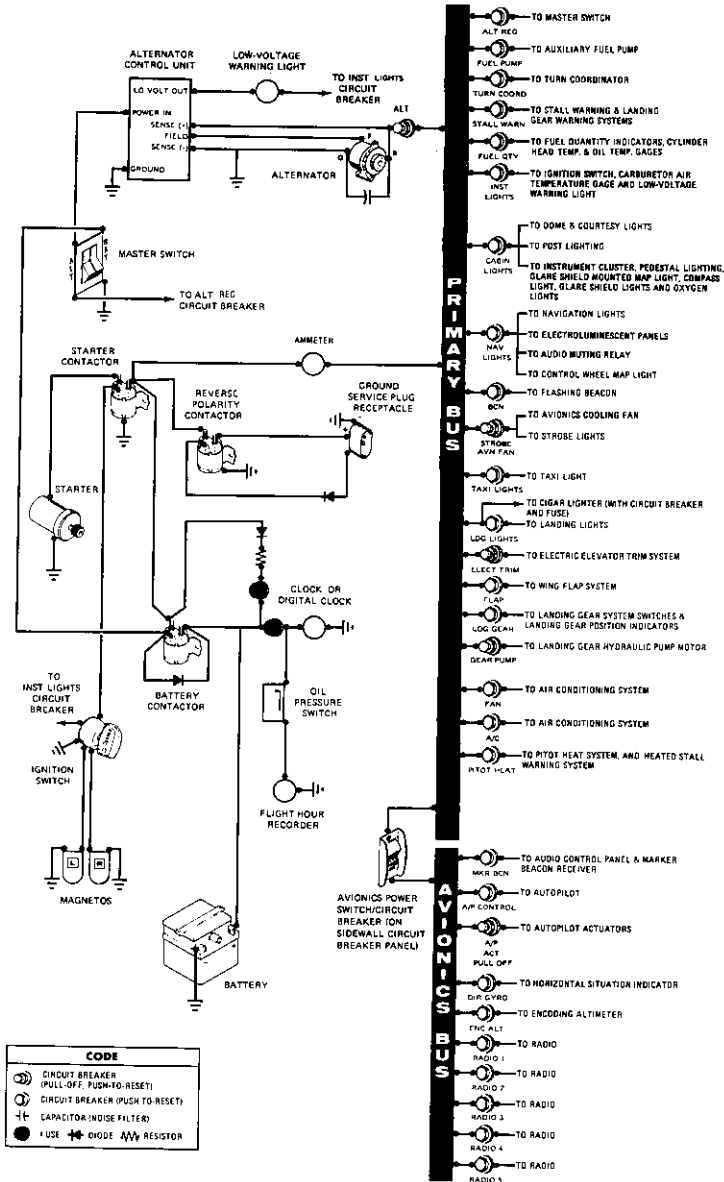

Figure 7-8. Electrical System

MASTER SWITCH

The master switch is a split-rocker type switch labeled MASTER, and is ON in the up position and off in the down position. The right half of the switch, labeled BAT, controls all electrical power to the airplane. The left half, labeled ALT, controls the alternator.

Normally, both sides of the master switch should be used simultaneously; however, the BAT side of the switch could be turned ON separately to check equipment while on the ground. To check or use avionics equipment or radios while on the ground, the avionics power switch must be turned ON. The ALT side of the switch, when placed in the off position, removes the alternator from the electrical system. With this switch in the off position, the entire electrical load is placed on the battery. Continued operation with the alternator switch in the off position will reduce battery power low enough to open the battery contactor, remove power from the alternator field, and prevent alternator restart.

AVIONICS POWER SWITCH

Electrical power from the airplane primary bus to the avionics bus (see figure 7-8) is controlled by a single-rocker switch/circuit breaker labeled AVN PWR. The switch is located on the left sidewall circuit breaker panel and is ON in the up position and OFF in the down position. With the switch in the OFF position, no electrical power will be applied to the avionics equipment, regardless of the position of the master switch or the individual equipment switches. The avionics power switch also functions as a circuit breaker. If an electrical malfunction should occur and cause the circuit breaker to open, electrical power to the avionics equipment will be interrupted and the switch will automatically move to the OFF position. If this occurs, allow the circuit breaker to cool approximately two minutes before placing the switch in the ON position again. If the circuit breaker opens again, do not reset it. The avionics power switch should be placed in the OFF position prior to turning the master switch ON or off, starting the engine, or applying an external power source, and may be utilized in place of the individual avionics equipment switches.

AMMETER

The ammeter, located between the fuel gages, indicates the amount of current, in amperes, from the alternator to the battery or from the battery to the airplane electrical system. When the engine is operating and the master switch is turned on, the ammeter indicates the charging rate applied to the battery. In the event the alternator is not functioning or the electrical load exceeds the output of the alternator, the ammeter indicates the battery discharge rate.

ALTERNATOR CONTROL UNIT AND LOW-VOLTAGE WARNING LIGHT

The airplane is equipped with a combination alternator regulator high-low voltage control unit mounted on the engine side of the firewall and a red warning light labeled LOW VOLTAGE, on the right side of the instrument panel adjacent to the manifold pressure/fuel pressure gage.

In the event an over-voltage condition occurs, the alternator control unit automatically removes alternator field current which shuts down the alternator. The battery will then supply system current as shown by a discharge rate on the ammeter. Under these conditions, depending on electrical system load, the low-voltage warning light will illuminate when system voltage drops below normal. The alternator control unit may be reset by turning the master switch off and back on again. If the warning light does not illuminate, normal alternator charging has resumed; however, if the light does illuminate again, a malfunction has occurred, and the flight should be terminated as soon as practicable.

NOTE

Illumination of the low-voltage light and ammeter discharge indications may occur during low RPM conditions with an electrical load on the system, such as during a low RPM taxi. Under these conditions, the light will go out at higher RPM. The master switch need not be recycled since an over-voltage condition has not occurred to de-activate the alternator system. Momentary illumination of the low-voltage warning light and/or ammeter needle deflection may also occur during startup of the landing gear system hydraulic pump motor.

The warning light may be tested by turning on the landing lights and momentarily turning off the ALT portion of the master switch while leaving the BAT portion turned on.

CIRCUIT BREAKERS AND FUSES

Most of the electrical circuits in the airplane are protected by "push-to-reset" type circuit breakers mounted on the lower left side of the switch and control panel. However, the alternator output, the avionics cooling fan/strobe light circuits, and the landing gear circuits are protected by "pull-off" type circuit breakers on the switch and control panel. In addition to the individual circuit breakers, a single-rocker switch/circuit breaker, labeled AVN PWR on the avionics panel, located on the left cabin sidewall between the forward doorpost and the switch and control panel, also protects the avionics systems. The cigar lighter is protected by a manually-reset type circuit breaker on the back of the lighter, and a fuse

behind the instrument panel. The control wheel map light (if installed) is protected by the NAV LIGHTS circuit breaker and a fuse behind the instrument panel. Electrical circuits which are not protected by circuit breakers are the battery contactor closing (external power) circuit, clock circuit, and flight hour recorder circuit. These circuits are protected by fuses mounted adjacent to the battery.

GROUND SERVICE PLUG RECEPTACLE

A ground service plug receptacle may be installed to permit the use of an external power source for cold weather starting and during lengthy maintenance work on the electrical and electronic equipment. Details of the ground service plug receptacle are presented in Section 9, Supplements.

LIGHTING SYSTEMS

EXTERIOR LIGHTING

Conventional navigation lights are located on the wing tips and tail stinger, and dual landing/taxi lights are installed in the cowl nose cap. Additional lighting is available and includes a strobe light on each wing tip, a flashing beacon on top of the vertical stabilizer, and two courtesy lights, one under each wing, just outboard of the cabin doors. Details of the strobe light system are presented in Section 9, Supplements. The courtesy lights are operated by a switch located on the left rear door post. All exterior lights, except the courtesy lights, are operated by rocker switches on the left switch and control panel. The switches are ON in the up position and off in the down position.

The flashing beacon should not be used when flying through clouds or overcast; the flashing light reflected from water droplets or particles in the atmosphere, particularly at night, can produce vertigo and loss of orientation.

INTERIOR LIGHTING

Instrument and control panel lighting is provided by flood and integral lighting, with electroluminescent and post lighting also available. Dual concentric light dimming rheostats on the left side of the switch and control panel control the intensity of all lighting. The following paragraphs describe the various lighting systems and their controls.

The left and right sides of the switch and control panel, and the marker beacon/audio control panel may be lighted by electroluminescent panels

which do not require light bulbs for illumination. To utilize this lighting, turn the NAV light rocker switch to the ON position and rotate the inner knob labeled EL PANEL, on the right dimming rheostat, clockwise to the desired light intensity.

Instrument panel flood lighting consists of four red lights on the underside of the glare shield, and two red flood lights in the forward section of the overhead console. This lighting is controlled by rotating the outer knob labeled FLOOD, on the left dimming rheostat, clockwise to the desired intensity.

The instrument panel may be equipped with post lights which are mounted at the edge of each instrument or control and provide direct lighting. This lighting is controlled by rotating the inner knob labeled POST, on the left dimming rheostat, clockwise to the desired light intensity. Flood and post lights may be used simultaneously by rotating both the FLOOD and POST knobs clockwise to the desired intensity for each type of lighting.

The engine instrument cluster, radio equipment, and magnetic compass have integral lighting and operate independently of post or flood lighting. To operate these lights, rotate the outer knob labeled ENG-RADIO, on the right dimming rheostat, clockwise to the desired intensity. However, for daylight operation, the compass and engine instrument lights may be turned off while still maintaining maximum light intensity for the digital readouts in the radio equipment. This is accomplished by rotating the ENG-RADIO knob full counterclockwise. Check that the flood lights, post lights, and electroluminescent lights are turned off for daylight operation by rotating the FLOOD, POST, and EL PANEL knobs full counterclockwise.

The control pedestal has two integral lights and, if the airplane is equipped with oxygen, the overhead console is illuminated by post lights. Pedestal and console light intensity is controlled by the knob labeled ENG-RADIO, on the right dimming rheostat.

Map lighting is provided by overhead console map lights and a glare shield mounted map light. The airplane may also be equipped with a control wheel map light. The overhead console map lights operate in conjunction with instrument panel flood lighting and consist of two openings just aft of the red instrument panel flood lights. The map light openings have sliding covers controlled by small round knobs which uncover the openings when moved toward each other. The covers should be kept closed unless the map lights are required. A map light and toggle switch, mounted in front of the pilot on the underside of the glare shield, is used for illuminating approach plates or other charts when using a control wheel mounted approach plate holder. The switch is labeled MAP LIGHT.

ON, OFF and light intensity is controlled by the knob labeled FLOOD, on the left dimming rheostat. The pilot's control wheel map light (if installed) illuminates the lower portion of the cabin in front of the pilot, and is used for checking maps and other flight data during night operation. The light is utilized by turning the NAV light switch to the ON position, and adjusting light intensity with the rheostat control knob on the bottom of the control wheel.

The airplane is equipped with a dome light aft of the overhead console. The light is operated by a slide-type switch, aft of the light lens, which turns the light on when moved to the right.

The most probable cause of a light failure is a burned out bulb; however, in the event any of the lighting systems fail to illuminate when turned on, check the appropriate circuit breaker. If the circuit breaker has opened (white button popped out), and there is no obvious indication of a short circuit (smoke or odor), turn off the light switch of the affected lights, reset the breaker, and turn the switch on again. If the breaker opens again, do not reset it.

CABIN HEATING, VENTILATING AND DEFROSTING SYSTEM

The temperature and volume of airflow into the cabin can be regulated by manipulation of the push-pull CABIN HEAT and CABIN AIR control knobs (see figure 7-9). Both control knobs are the double button type with locks to permit intermediate settings.

NOTE

For improved partial heating on mild days, pull out the CABIN AIR knob slightly when the CABIN HEAT knob is out. This action increases the airflow through the system, increasing efficiency, and blends cool outside air with the exhaust manifold heated air, thus eliminating the possibility of overheating the system ducting.

Front cabin heat and ventilating air is supplied by outlet holes spaced across a cabin manifold just forward of the pilot's and copilot's feet. Rear cabin heat and air is supplied by two ducts from the manifold, one extending down each side of the cabin to an outlet at the front door post at floor level. Windshield defrost air is also supplied by a duct leading from the cabin manifold to an outlet on top of the antiglare shield. Defrost air flow is controlled by a rotary type knob labeled DEFROST.

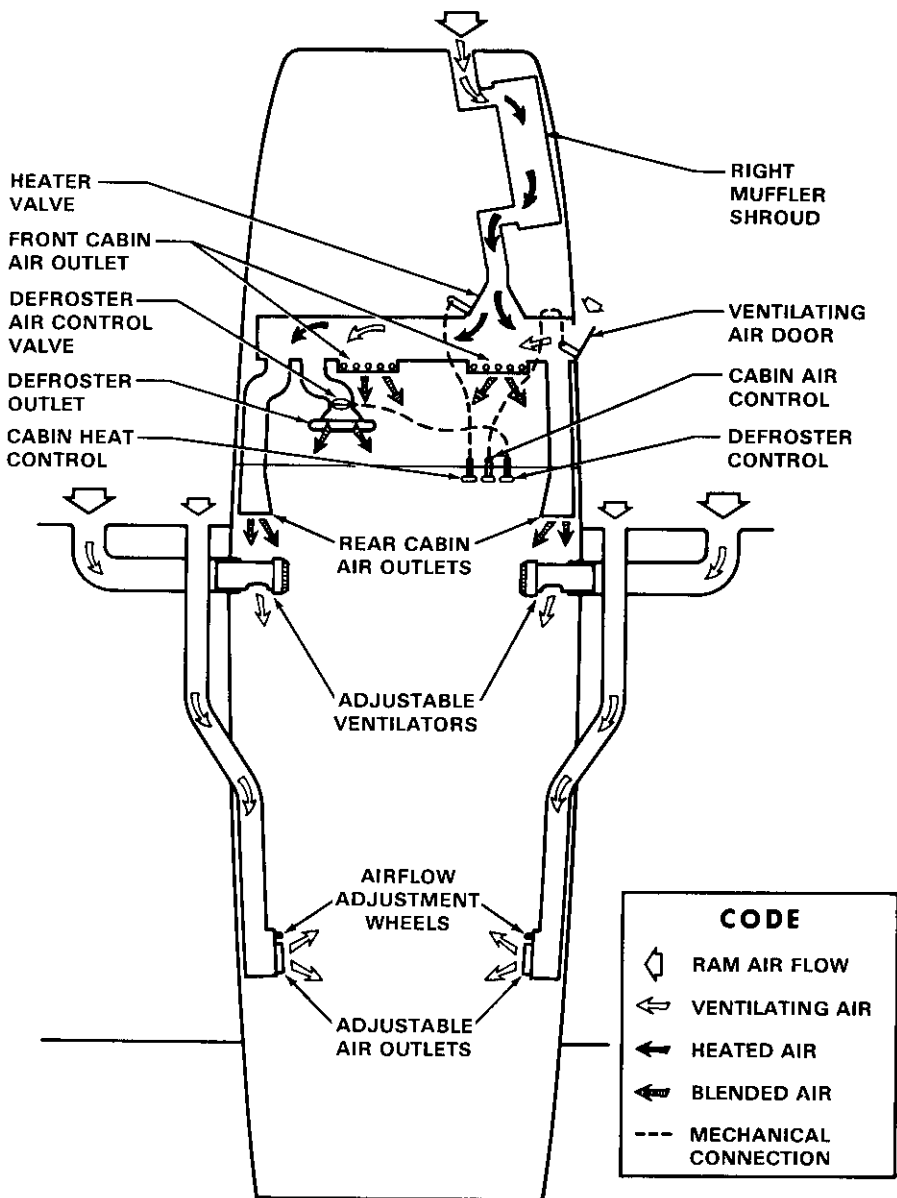

Figure 7-9. Cabin Heating, Ventilating, and Defrosting System

For cabin ventilation, pull the CABIN AIR knob out, with the CABIN HEAT knob pushed full in. To raise the air temperature, pull the CABIN HEAT knob out until the desired temperature is attained. Additional heat is available by pulling the knob out farther; maximum heat is available with the CABIN HEAT knob pulled out and the CABIN AIR knob pushed full in.

Separate adjustable ventilators supply additional ventilation air to the cabin. One near each upper corner of the windshield supplies air for the pilot and copilot, and two ventilators are available for the rear cabin area to supply air to the rear seat passengers. Each rear ventilator outlet can be adjusted in any desired direction by moving the entire outlet to direct the airflow up or down, and by moving a tab protruding from the center of the outlet left or right to obtain left or right airflow. Ventilation airflow may be closed off completely, or partially closed according to the amount of airflow desired, by rotating an adjustment wheel adjacent to the outlet. An air conditioning system may be installed in the airplane. Details of this system are presented in Section 9, Supplements.

PITOT-STATIC SYSTEM AND INSTRUMENTS

The pitot-static system supplies ram air pressure to the airspeed indicator and static pressure to the airspeed indicator, vertical speed indicator and altimeter. The system is composed of either an unheated or heated pitot tube mounted on the lower surface of the left wing, two external static ports on the left and right sides of the forward fuselage, and the associated plumbing necessary to connect the instruments to the sources.

The heated pitot system (if installed) consists of a heating element in the pitot tube, a rocker switch labeled PITOT HEAT, a 10-amp "push-to reset" type circuit breaker on the left sidewall circuit breaker panel, and associated wiring. When the pitot heat switch is turned on, the element in the pitot tube is heated electrically to maintain proper operation in possible icing conditions. Pitot heat should be used only as required.

A static pressure alternate source valve may be installed adjacent to the parking brake, and can be used if the external static source is malfunctioning. This valve supplies static pressure from inside the cabin instead of the external static ports.

If erroneous instrument readings are suspected due to water or ice in the pressure line going to the standard external static pressure source, the alternate static source valve should be pulled on.

Pressures within the cabin will vary with heater/vents opened or closed and windows open. Refer to Sections 3 and 5 for the effect of varying cabin pressures on airspeed and altimeter readings.

AIRSPPEED INDICATOR

The airspeed indicator is calibrated in knots and miles per hour. Limitation and range markings (in KIAS) include the white arc (39 to 95 knots), green arc (41 to 159 knots), yellow arc (159 to 181 knots), and a red line (181 knots).

If a true airspeed indicator is installed, it is equipped with a rotatable ring which works in conjunction with the airspeed indicator dial in a manner similar to the operation of a flight computer. To operate the indicator, first rotate the ring until **pressure** altitude is aligned with outside air temperature in degrees Fahrenheit. Pressure altitude should not be confused with indicated altitude. To obtain pressure altitude, momentarily set the barometric scale on the altimeter to 29.92 and read pressure altitude on the altimeter. Be sure to return the altimeter barometric scale to the original barometric setting after pressure altitude has been obtained. Having set the ring to correct for altitude and temperature, read the true airspeed shown on the rotatable ring by the indicator pointer. For best accuracy, the indicated airspeed should be corrected to calibrated airspeed by referring to the Airspeed Calibration chart in Section 5. Knowing the calibrated airspeed, read true airspeed on the ring opposite the calibrated airspeed.

VERTICAL SPEED INDICATOR

The vertical speed indicator depicts airplane rate of climb or descent in feet per minute. The pointer is actuated by atmospheric pressure changes resulting from changes of altitude as supplied by the static source.

ALTIMETER

Airplane altitude is depicted by a barometric type altimeter. A knob near the lower left portion of the indicator provides adjustment of the instrument's barometric scale to the current altimeter setting.

VACUUM SYSTEM AND INSTRUMENTS

An engine-driven vacuum system (see figure 7-10) provides the suction necessary to operate the attitude indicator and directional indicator. The system consists of a vacuum pump mounted on the engine, a vacuum relief valve and vacuum system air filter on the aft side of the

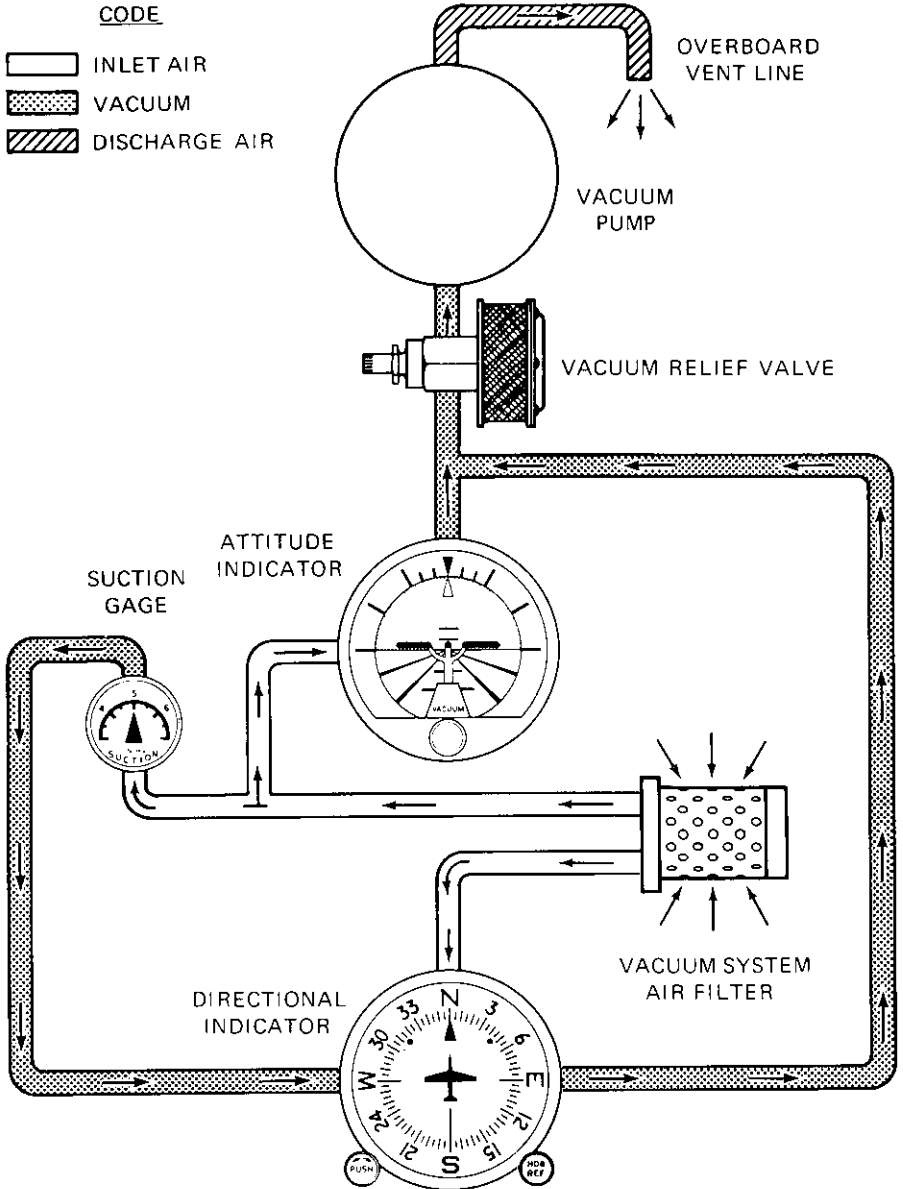

Figure 7-10. Vacuum System

firewall below the instrument panel, and instruments (including a suction gage) on the left side of the instrument panel.

ATTITUDE INDICATOR

An attitude indicator is available and gives a visual indication of flight attitude. Bank attitude is presented by a pointer at the top of the indicator relative to the bank scale which has index marks at 10°, 20°, 30°, 60°, and 90° either side of the center mark. Pitch and roll attitudes are presented by a miniature airplane superimposed over a symbolic horizon area divided into two sections by a white horizon bar. The upper "blue sky" area and the lower "ground" area have arbitrary, pitch reference lines useful for pitch attitude control. A knob at the bottom of the instrument is provided for in-flight adjustment of the miniature airplane to the horizon bar for a more accurate flight attitude indication.

DIRECTIONAL INDICATOR

A directional indicator displays airplane heading on a compass card in relation to a fixed simulated airplane image and index. The directional indicator will precess slightly over a period of time. Therefore, the compass card should be set in accordance with the magnetic compass just prior to takeoff, and occasionally re-adjusted on extended flights. A knob on the lower left edge of the instrument is used to adjust the compass card to correct for any precession.

SUCTION GAGE

The suction gage, located below the flight instruments, is calibrated in inches of mercury and indicates suction available for operation of the attitude and directional indicators. The desired suction range is 4.5 to 5.4 inches of mercury. A suction reading out of this range may indicate a system malfunction or improper adjustment, and in this case, the indicators should not be considered reliable.

STALL WARNING SYSTEM

The airplane is equipped with a vane-type stall warning unit, in the leading edge of the left wing, which is electrically connected to a stall warning horn under the map compartment. A 5-amp "push-to-reset" type circuit breaker labeled STALL WARN, on the left side of the switch and control panel, protects the stall warning system. The vane in the wing senses the change in airflow over the wing, and operates the warning horn at airspeeds between 5 and 10 knots above the stall in all configurations.

If the airplane has a heated stall warning system, the vane and sensor unit in the wing leading edge is equipped with a heating element. The heated part of the system is operated by the PITOT HEAT switch, and is protected by the PITOT HEAT circuit breaker.

The stall warning system should be checked during the pre-flight inspection by momentarily turning on the master switch and actuating the vane in the wing. The system is operational if the warning horn sounds as the vane is pushed upward.

AVIONICS SUPPORT EQUIPMENT

If the airplane is equipped with avionics, various avionics support equipment may also be installed. Equipment available includes an avionics cooling fan, microphone-headset installations and control surface static dischargers. The following paragraphs discuss these items. Description and operation of radio equipment is covered in Section 9 of this handbook.

AVIONICS COOLING FAN

An avionics cooling fan system is provided whenever a factory-installed Nav/Com radio is installed. The system is designed to provide internal cooling air from a small electric fan to the avionics units and thereby eliminate the possibility of moisture contamination using an external cooling air source.

Power to the electric fan is supplied directly from a "pull-off" type circuit breaker labeled STROBE, AVN FAN, located on the left switch and control panel. Hence, power is supplied to the fan anytime the master switch is ON. This arrangement provides air circulation through the radios to remove a possible heat soak condition before the radios are turned on after engine start. It is recommended that the circuit breaker be left ON except during periods of lengthy maintenance with the master switch ON.

MICROPHONE-HEADSET INSTALLATIONS

Three types of microphone-headset installations are offered. The standard system provided with avionics equipment includes a hand-held microphone and separate headset. The keying switch for this microphone is on the microphone. Two optional microphone-headset installations are also available; these feature a single-unit microphone-headset combination which permits the pilot or front passenger to conduct radio communications without interrupting other control operations to handle a hand-

held microphone. One microphone-headset combination is a lightweight type without a padded headset and the other version has a padded headset. The microphone-headset combinations utilize a remote keying switch located on the left grip of the pilot's control wheel and, if an optional intercom system is installed, a second switch on the right grip of the front passenger's control wheel. The microphone and headset jacks are located on the lower left and right sides of the instrument panel. Audio to all three headsets is controlled by the individual audio selector switches and adjusted for volume level by using the selected receiver volume controls.

NOTE

When transmitting, with the hand-held microphone, the pilot should key the microphone, place the microphone as close as possible to the lips and speak directly into it.

STATIC DISCHARGERS

If frequent IFR flights are planned, installation of wick-type static dischargers is recommended to improve radio communications during flight through dust or various forms of precipitation (rain, snow or ice crystals). Under these conditions, the build-up and discharge of static electricity from the trailing edges of the wings, rudder, elevator, propeller tips, and radio antennas can result in loss of usable radio signals on all communications and navigation radio equipment. Usually the ADF is first to be affected and VHF communication equipment is the last to be affected.

Installation of static dischargers reduces interference from precipitation static, but it is possible to encounter severe precipitation static conditions which might cause the loss of radio signals, even with static dischargers installed. Whenever possible, avoid known severe precipitation areas to prevent loss of dependable radio signals. If avoidance is impractical, minimize airspeed and anticipate temporary loss of radio signals while in these areas.

SECTION 8

AIRPLANE HANDLING, SERVICE & MAINTENANCE

TABLE OF CONTENTS

	Page
Introduction	8-3
Identification Plate	8-3
Owner Follow-Up System	8-3
Publications	8-3
Airplane File	8-4
Airplane Inspection Periods	8-5
FAA Required Inspections	8-5
Cessna Progressive Care	8-6
Cessna Customer Care Program	8-6
Pilot Conducted Preventive Maintenance	8-7
Alterations or Repairs	8-7
Ground Handling	8-8
Towing	8-8
Parking	8-8
Tie-Down	8-8
Jacking	8-8
Leveling	8-9
Flyable Storage	8-9
Servicing	8-10
Engine Oil	8-10
Fuel	8-12
Landing Gear	8-14
Oxygen	8-15
Cleaning and Care	8-15
Windshield-Windows	8-15
Painted Surfaces	8-15
Propeller Care	8-16
Landing Gear Care	8-16
Engine Care	8-16
Interior Care	8-17

INTRODUCTION

This section contains factory-recommended procedures for proper ground handling and routine care and servicing of your Cessna. It also identifies certain inspection and maintenance requirements which must be followed if your airplane is to retain that new-plane performance and dependability. It is wise to follow a planned schedule of lubrication and preventive maintenance based on climatic and flying conditions encountered in your locality.

Keep in touch with your Cessna Dealer and take advantage of his knowledge and experience. He knows your airplane and how to maintain it. He will remind you when lubrications and oil changes are necessary, and about other seasonal and periodic services.

IDENTIFICATION PLATE

All correspondence regarding your airplane should include the SERIAL NUMBER. The Serial Number, Model Number, Production Certificate Number (PC) and Type Certificate Number (TC) can be found on the Identification Plate, located on the left forward doorpost. Located adjacent to the Identification Plate is a Finish and Trim Plate which contains a code describing the interior color scheme and exterior paint combination of the airplane. The code may be used in conjunction with an applicable Parts Catalog if finish and trim information is needed.

OWNER FOLLOW-UP SYSTEM

Your Cessna Dealer has an Owner Follow-Up System to notify you when he receives information that applies to your Cessna. In addition, if you wish, you may choose to receive similar notification, in the form of Service Letters, directly from the Cessna Customer Services Department. A subscription form is supplied in your Customer Care Program book for your use, should you choose to request this service. Your Cessna Dealer will be glad to supply you with details concerning these follow-up programs, and stands ready, through his Service Department, to supply you with fast, efficient, low-cost service.

PUBLICATIONS

Various publications and flight operation aids are furnished in the

airplane when delivered from the factory. These items are listed below.

- CUSTOMER CARE PROGRAM BOOK
- PILOT'S OPERATING HANDBOOK AND FAA APPROVED AIRPLANE FLIGHT MANUAL
- AVIONICS OPERATION GUIDE
- PILOT'S CHECKLISTS
- POWER COMPUTER
- CUSTOMER CARE DEALER DIRECTORY

The following additional publications, plus many other supplies that are applicable to your airplane, are available from your Cessna Dealer.

- INFORMATION MANUAL (Contains Pilot's Operating Handbook Information)
- SERVICE MANUALS AND PARTS CATALOGS FOR YOUR:
AIRPLANE
ENGINE AND ACCESSORIES
AVIONICS AND AUTOPILOT

Your Cessna Dealer has a Customer Care Supplies Catalog covering all available items, many of which he keeps on hand. He will be happy to place an order for any item which is not in stock.

NOTE

A Pilot's Operating Handbook and FAA Approved Airplane Flight Manual which is lost or destroyed may be replaced by contacting your Cessna Dealer or writing directly to the Customer Services Department, Cessna Aircraft Company, Wichita, Kansas. An affidavit containing the owner's name, airplane serial number and registration number must be included in replacement requests since the Pilot's Operating Handbook and FAA Approved Airplane Flight Manual is identified for specific airplanes only.

AIRPLANE FILE

There are miscellaneous data, information and licenses that are a part of the airplane file. The following is a checklist for that file. In addition, a periodic check should be made of the latest Federal Aviation Regulations to ensure that all data requirements are met.

- A. To be displayed in the airplane at all times:
1. Aircraft Airworthiness Certificate (FAA Form 8100-2).
 2. Aircraft Registration Certificate (FAA Form 8050-3).
 3. Aircraft Radio Station License, if transmitter installed (FCC Form 556).
- B. To be carried in the airplane at all times:
1. Pilot's Operating Handbook and FAA Approved Airplane Flight Manual.
 2. Weight and Balance, and associated papers (latest copy of the Repair and Alteration Form, FAA Form 337, if applicable).
 3. Equipment List.
- C. To be made available upon request:
1. Airplane Log Book.
 2. Engine Log Book.

Most of the items listed are required by the United States Federal Aviation Regulations. Since the Regulations of other nations may require other documents and data, owners of airplanes not registered in the United States should check with their own aviation officials to determine their individual requirements.

Cessna recommends that these items, plus the Pilot's Checklists, Power Computer, Customer Care Program book and Customer Care Card, be carried in the airplane at all times.

AIRPLANE INSPECTION PERIODS

FAA REQUIRED INSPECTIONS

As required by Federal Aviation Regulations, all civil aircraft of U.S. registry must undergo a complete inspection (annual) each twelve calendar months. In addition to the required ANNUAL inspection, aircraft operated commercially (for hire) must have a complete inspection every 100 hours of operation.

The FAA may require other inspections by the issuance of airworthiness directives applicable to the airplane, engine, propeller and components. It is the responsibility of the owner/operator to ensure compliance with all applicable airworthiness directives and, when the inspections are repetitive, to take appropriate steps to prevent inadvertent noncompliance.

In lieu of the 100 HOUR and ANNUAL inspection requirements, an airplane may be inspected in accordance with a progressive inspection schedule, which allows the work load to be divided into smaller operations that can be accomplished in shorter time periods.

The CESSNA PROGRESSIVE CARE PROGRAM has been developed to provide a modern progressive inspection schedule that satisfies the complete airplane inspection requirements of both the 100 HOUR and ANNUAL inspections as applicable to Cessna airplanes. The program assists the owner in his responsibility to comply with all FAA inspection requirements, while ensuring timely replacement of life-limited parts and adherence to factory-recommended inspection intervals and maintenance procedures.

CESSNA PROGRESSIVE CARE

The Cessna Progressive Care Program has been designed to help you realize maximum utilization of your airplane at a minimum cost and downtime. Under this program, your airplane is inspected and maintained in four operations at 50-hour intervals during a 200-hour period. The operations are recycled each 200 hours and are recorded in a specially provided Aircraft Inspection Log as each operation is conducted.

The Cessna Aircraft Company recommends Progressive Care for airplanes that are being flown 200 hours or more per year, and the 100-hour inspection for all other airplanes. The procedures for the Progressive Care Program and the 100-hour inspection have been carefully worked out by the factory and are followed by the Cessna Dealer Organization. The complete familiarity of Cessna Dealers with Cessna equipment and factory-approved procedures provides the highest level of service possible at lower cost to Cessna owners.

Regardless of the inspection method selected by the owner, he should keep in mind that FAR Part 43 and FAR Part 91 establishes the requirement that properly certified agencies or personnel accomplish all required FAA inspections and most of the manufacturer recommended inspections.

CESSNA CUSTOMER CARE PROGRAM

Specific benefits and provisions of the CESSNA WARRANTY plus other important benefits for you are contained in your CUSTOMER CARE PROGRAM book supplied with your airplane. You will want to thoroughly review your Customer Care Program book and keep it in your airplane at all times.

Coupons attached to the Program book entitle you to an initial inspection and either a Progressive Care Operation No.1 or the first 100-

hour inspection within the first 6 months of ownership at no charge to you. If you take delivery from your Dealer, the initial inspection will have been performed before delivery of the airplane to you. If you pick up your airplane at the factory, plan to take it to your Dealer reasonably soon after you take delivery, so the initial inspection may be performed allowing the Dealer to make any minor adjustments which may be necessary.

You will also want to return to your Dealer either at 50 hours for your first Progressive Care Operation, or at 100 hours for your first 100-hour inspection depending on which program you choose to establish for your airplane. While these important inspections will be performed for you by any Cessna Dealer, in most cases you will prefer to have the Dealer from whom you purchased the airplane accomplish this work.

PILOT CONDUCTED PREVENTIVE MAINTENANCE

A certified pilot who owns or operates an airplane not used as an air carrier is authorized by FAR Part 43 to perform limited maintenance on his airplane. Refer to FAR Part 43 for a list of the specific maintenance operations which are allowed.

NOTE

Pilots operating airplanes of other than U.S. registry should refer to the regulations of the country of certification for information on preventive maintenance that may be performed by pilots.

A Service Manual should be obtained prior to performing any preventive maintenance to ensure that proper procedures are followed. Your Cessna Dealer should be contacted for further information or for required maintenance which must be accomplished by appropriately licensed personnel.

ALTERATIONS OR REPAIRS

It is essential that the FAA be contacted **prior to** any alterations on the airplane to ensure that airworthiness of the airplane is not violated. Alterations or repairs to the airplane must be accomplished by licensed personnel.

GROUND HANDLING

TOWING

The airplane is most easily and safely maneuvered by hand with the tow-bar attached to the nose wheel. When towing with a vehicle, do not exceed the nose gear turning angle of 30° either side of center, or damage to the gear will result. If the airplane is towed or pushed over a rough surface during hangaring, watch that the normal cushioning action of the nose strut does not cause excessive vertical movement of the tail and the resulting contact with low hangar doors or structure. A flat nose tire or deflated strut will also increase tail height.

PARKING

When parking the airplane, head into the wind and set the parking brakes. Do not set the parking brakes during cold weather when accumulated moisture may freeze the brakes, or when the brakes are overheated. Close the cowl flaps, install the control wheel lock and chock the wheels. In severe weather and high wind conditions, tie the airplane down as outlined in the following paragraph.

TIE-DOWN

Proper tie-down procedure is the best precaution against damage to the parked airplane by gusty or strong winds. To tie-down the airplane securely, proceed as follows:

1. Set the parking brake and install the control wheel lock.
2. Install a surface control lock over the fin and rudder.
3. Tie sufficiently strong ropes or chains (700 pounds tensile strength) to the wing and tail tie-down fittings and secure each rope to a ramp tie-down.
4. Tie a rope (no chains or cables) to the nose gear torque link and secure to a ramp tie-down.
5. Install a pitot tube cover.

JACKING

When a requirement exists to jack one or both main gear, the entire airplane should be jacked by using the wing jack points. Refer to the Service Manual for specific procedures and equipment required.

If nose gear maintenance is required, the nose wheel may be raised off the ground by pressing down on a tailcone bulkhead, just forward of the horizontal stabilizer, and allowing the tail to rest on the tail tie-down ring.

NOTE

Do not apply pressure on the elevator or outboard stabilizer surfaces. When pushing on the tailcone, always apply pressure at a bulkhead to avoid buckling the skin.

To assist in raising and holding the nose wheel off the ground, weight down the tail by placing sand-bags, or suitable weights, on each side of the horizontal stabilizer, next to the fuselage. If ground anchors are available, the tail should be securely tied down.

NOTE

Ensure that the nose will be held off the ground under all conditions by means of suitable stands or supports under weight supporting bulkheads near the nose of the airplane.

LEVELING

Longitudinal leveling of the airplane is accomplished by placing a level on the leveling screws located on the left side of the tailcone. Deflate the nose tire and/or lower or raise the nose strut to properly center the bubble in the level. Corresponding points on both upper door sills may be used to level the airplane laterally.

FLYABLE STORAGE

Airplanes placed in non-operational storage for a maximum of 30 days or those which receive only intermittent operational use for the first 25 hours are considered in flyable storage status. Every seventh day during these periods, the propeller should be rotated by hand through five revolutions. This action "limbers" the oil and prevents any accumulation of corrosion on engine cylinder walls.

WARNING

For maximum safety, check that the ignition switch is OFF, the throttle is closed, the mixture control is in the idle cut-off position, and the airplane is secured before rotating the propeller by hand. Do not stand within the arc of the propeller blades while turning the propeller.

After 30 days, the airplane should be flown for 30 minutes or a ground runup should be made just long enough to produce an oil temperature within the lower green arc range. Excessive ground runup should be avoided.

Engine runup also helps to eliminate excessive accumulations of water in the fuel system and other air spaces in the engine. Keep fuel tanks full to minimize condensation in the tanks. Keep the battery fully charged to prevent the electrolyte from freezing in cold weather. If the airplane is to be stored temporarily, or indefinitely, refer to the Service Manual for proper storage procedures.

SERVICING

In addition to the PREFLIGHT INSPECTION covered in Section 4, COMPLETE servicing, inspection, and test requirements for your airplane are detailed in the Service Manual. The Service Manual outlines all items which require attention at 50, 100, and 200 hour intervals plus those items which require servicing, inspection, and/or testing at special intervals.

Since Cessna Dealers conduct all service, inspection, and test procedures in accordance with applicable Service Manuals, it is recommended that you contact your Cessna Dealer concerning these requirements and begin scheduling your airplane for service at the recommended intervals.

Cessna Progressive Care ensures that these requirements are accomplished at the required intervals to comply with the 100-hour or ANNUAL inspection as previously covered.

Depending on various flight operations, your local Government Aviation Agency may require additional service, inspections, or tests. For these regulatory requirements, owners should check with local aviation officials where the airplane is being operated.

For quick and ready reference, quantities, materials, and specifications for frequently used service items are as follows:

ENGINE OIL

GRADE AND VISCOSITY FOR TEMPERATURE RANGE --

The airplane was delivered from the factory with aviation grade straight mineral oil. This oil should be drained after the first 25 hours of operation, and the following oils used as specified for the average ambient air temperature in the operating area.

MIL-L-6082 Aviation Grade Straight Mineral Oil: Use to replenish supply during the first 25 hours and at the first 25-hour oil change. Continue to use until a total of 50 hours has accumulated or oil consumption has stabilized.

- All temperatures, use SAE 20W-50 or
- Above 16°C (60°F), use SAE 50
- 1°C (30°F) to 32°C (90°F), use SAE 40

-18°C (0°F) to 21°C (70°F), use SAE 30

Below -12°C (10°F), use SAE 20

MIL-L-22851 Ashless Dispersant Oil: This oil **must be used** after the first 50 hours or oil consumption has stabilized.

All temperatures, use SAE 20W-50 or

Above 16°C (60°F), use SAE 40 or SAE 50

-1°C (30°F) to 32°C (90°F), use SAE 40

-18°C (0°F) to 21°C (70°F), use SAE 40 or SAE 30

Below -12°C (10°F), use SAE 30

CAPACITY OF ENGINE SUMP -- 8 Quarts.

Do not operate on less than 5 quarts. To minimize loss of oil through breather, fill to 7 quart level for normal flights of less than 3 hours. For extended flight, fill to 8 quarts. These quantities refer to oil dipstick level readings. During oil and oil filter changes, one additional quart is required.

OIL AND OIL FILTER CHANGE --

After the first 25 hours of operation, drain engine oil sump and change the filter. Refill sump with straight mineral oil and use until a total of 50 hours has accumulated or oil consumption has stabilized; then change to dispersant oil. Drain the engine oil sump and change the filter each 50 hours thereafter. The oil change interval may be extended to 100-hour intervals, providing the oil filter is changed at 50-hour intervals. Change engine oil at least every 6 months even though less than the recommended hours have accumulated. Reduce intervals for prolonged operation in dusty areas, cold climates, or when short flights and long idle periods result in sludging conditions.

NOTE

During the first 25-hour oil and filter change, a general inspection of the overall engine compartment is required. Items which are not normally checked during a preflight inspection should be given special attention. Hoses, metal lines and fittings should be inspected for signs of oil and fuel leaks, and checked for abrasions, chafing, security, proper routing and support, and evidence of deterioration. Inspect the intake and exhaust systems for cracks, evidence of leakage, and security of attachment. Engine controls and linkages should be checked for freedom of movement through their full range, security of attachment and evidence of wear. Inspect wiring for security, chafing, burning, defective insulation, loose or broken terminals, heat deterioration, and corroded terminals. Check the alternator belt in accordance with Service Manual instructions, and retighten if necessary. A periodic check of these

items during subsequent servicing operations is recommended.

FUEL

APPROVED FUEL GRADES (AND COLORS) --
100LL Grade Aviation Fuel (Blue).
100 (Formerly 100/130) Grade Aviation Fuel (Green).

NOTE

Isopropyl alcohol or ethylene glycol monomethyl ether may be added to the fuel supply in quantities not to exceed 1% or .15% by volume, respectively, of the total. Refer to Fuel Additives in later paragraphs for additional information.

CAPACITY EACH TANK -- 46.0 U.S. Gallons.
REDUCED CAPACITY EACH TANK (WHEN FILLED TO BOTTOM OF FUEL FILLER NECK) -- 34.5 U.S. Gallons.

NOTE

To ensure maximum fuel capacity when refueling and minimize cross-feeding when parked on a sloping surface, place the fuel selector valve handle in either LEFT or RIGHT position.

NOTE

Service the fuel system after each flight, and keep fuel tanks full to minimize condensation in the tanks.

FUEL ADDITIVES --

Strict adherence to recommended preflight draining instructions as called for in Section 4 will eliminate any free water accumulations from the tank sumps. While small amounts of water may still remain in solution in the gasoline, it will normally be consumed and go unnoticed in the operation of the engine.

One exception to this can be encountered when operating under the combined effect of: (1) use of certain fuels, with (2) high humidity conditions on the ground (3) followed by flight at high altitude and low temperature. Under these unusual conditions, small amounts of water in solution can precipitate from the fuel stream and freeze in sufficient quantities to induce partial icing of the engine fuel system.

While these conditions are quite rare and will not normally pose a

problem to owners and operators, they do exist in certain areas of the world and consequently must be dealt with, when encountered.

Therefore, to alleviate the possibility of fuel icing occurring under these unusual conditions, it is permissible to add isopropyl alcohol or ethylene glycol monomethyl ether (EGME) compound to the fuel supply.

The introduction of alcohol or EGME compound into the fuel provides two distinct effects: (1) it absorbs the dissolved water from the gasoline and (2) alcohol has a freezing temperature depressant effect.

Alcohol, if used, is to be blended with the fuel in a concentration of 1% by volume. Concentrations greater than 1% are not recommended since they can be detrimental to fuel tank materials.

The manner in which the alcohol is added to the fuel is significant because alcohol is most effective when it is completely dissolved in the fuel. To ensure proper mixing, the following is recommended:

1. For best results, the alcohol should be added during the fueling operation by pouring the alcohol directly on the fuel stream issuing from the fueling nozzle.
2. An alternate method that may be used is to premix the complete alcohol dosage with some fuel in a separate clean container (approximately 2-3 gallon capacity) and then transferring this mixture to the tank prior to the fuel operation.

Any high quality isopropyl alcohol may be used, such as Anti-Icing Fluid (MIL-F-5566) or Isopropyl Alcohol (Federal Specification TT-I-735a). Figure 8-1 provides alcohol-fuel mixing ratio information.

Ethylene glycol monomethyl ether (EGME) compound, in compliance with MIL-I-27686 or Phillips PFA-55MB, if used, must be carefully mixed with the fuel in concentrations not to exceed .15% by volume. Figure 8-1 provides EGME-fuel mixing ratio information.

CAUTION

Mixing of the EGME compound with the fuel is extremely important because a concentration in excess of that recommended (.15% by volume maximum) will result in detrimental effects to the fuel tanks, such as deterioration of protective primer and sealants and damage to O-rings and seals in the fuel system and engine components. Use only blending equipment that is recommended by the manufacturer to obtain proper proportioning.

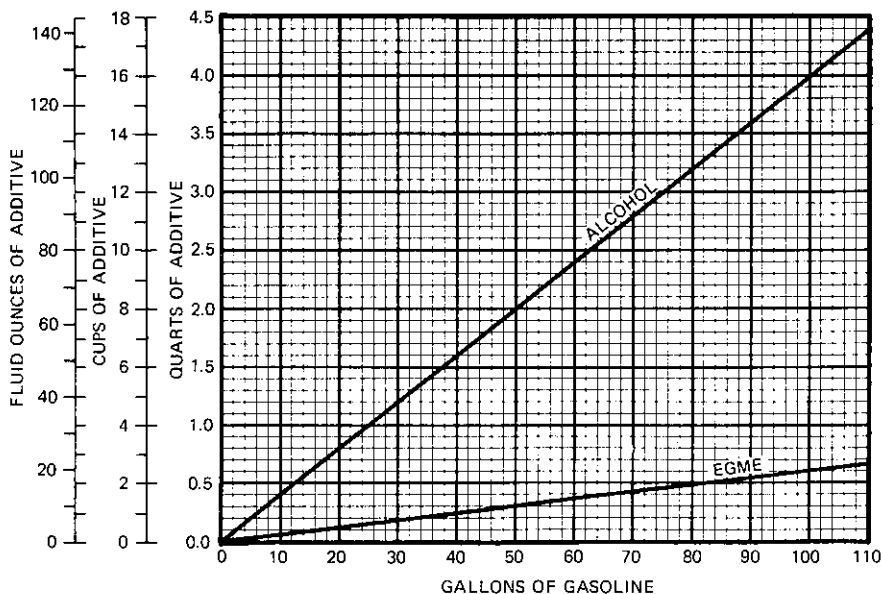

Figure 8-1. Additive Mixing Ratio

CAUTION

Do not allow the concentrated EGME compound to come in contact with the airplane finish or fuel cell as damage can result.

Prolonged storage of the airplane will result in a water buildup in the fuel which "leeches out" the additive. An indication of this is when an excessive amount of water accumulates in the fuel tank sumps. The concentration can be checked using a differential refractometer. It is imperative that the technical manual for the differential refractometer be followed explicitly when checking the additive concentration.

LANDING GEAR

NOSE WHEEL TIRE PRESSURE -- 50 PSI on 5.00-5, 6-Ply Rated Tire.
MAIN WHEEL TIRE PRESSURE -- 68 PSI on 15 x 6.00-6, 6-Ply Rated Tires.
NOSE GEAR SHOCK STRUT --

Keep filled with MIL-H-5606 hydraulic fluid per filling instructions placard, and with no load on the strut, inflate with air to 55 PSI. Do not over-inflate.

HYDRAULIC FLUID RESERVOIR -- Check every 25 hours and service with MIL-H-5606 hydraulic fluid.

OXYGEN

AVIATOR'S BREATHING OXYGEN -- Spec. No. MIL-O-27210.
MAXIMUM PRESSURE (cylinder temperature stabilized after filling) --
1800 PSI at 21°C (70°F). Refer to Oxygen System Supplement (Section
9) for filling pressures.

CLEANING AND CARE

WINDSHIELD-WINDOWS

The plastic windshield and windows should be cleaned with an aircraft windshield cleaner. Apply the cleaner sparingly with soft cloths, and rub with moderate pressure until all dirt, oil scum and bug stains are removed. Allow the cleaner to dry, then wipe it off with soft flannel cloths.

If a windshield cleaner is not available, the plastic can be cleaned with soft cloths moistened with Stoddard solvent to remove oil and grease.

NOTE

Never use gasoline, benzine, alcohol, acetone, fire extinguisher or anti-ice fluid, lacquer thinner or glass cleaner to clean the plastic. These materials will attack the plastic and may cause it to craze.

Follow by **carefully** washing with a mild detergent and plenty of water. Rinse thoroughly, then dry with a clean moist chamois. **Do not rub** the plastic with a dry cloth since this builds up an electrostatic charge which attracts dust. Waxing with a good commercial wax will finish the cleaning job. A thin, even coat of wax, polished out by hand with clean soft flannel cloths, will fill in minor scratches and help prevent further scratching.

Do not use a canvas cover on the windshield unless freezing rain or sleet is anticipated since the cover may scratch the plastic surface.

PAINTED SURFACES

The painted exterior surfaces of your new Cessna have a durable, long lasting finish and, under normal conditions, require no polishing or buffing. Approximately 10 days are required for the paint to cure completely; in most cases, the curing period will have been completed prior to delivery of the airplane. In the event that polishing or buffing is required within the curing period, it is recommended that the work be done by someone experienced in handling uncured paint. Any Cessna Dealer can accomplish this work.

Generally, the painted surfaces can be kept bright by washing with

water and mild soap, followed by a rinse with water and drying with cloths or a chamois. Harsh or abrasive soaps or detergents which cause corrosion or scratches should never be used. Remove stubborn oil and grease with a cloth moistened with Stoddard solvent.

Waxing is unnecessary to keep the painted surfaces bright. However, if desired, the airplane may be waxed with a good automotive wax. A heavier coating of wax on the leading edges of the wings and tail and on the engine nose cap and propeller spinner will help reduce the abrasion encountered in these areas.

When the airplane is parked outside in cold climates and it is necessary to remove ice before flight, care should be taken to protect the painted surfaces during ice removal with chemical liquids. Isopropyl alcohol will satisfactorily remove ice accumulations without damaging the paint. While applying the de-icing solution, keep it away from the windshield and cabin windows since the alcohol will attack the plastic and may cause it to craze.

PROPELLER CARE

Preflight inspection of propeller blades for nicks, and wiping them occasionally with an oily cloth to clean off grass and bug stains will assure long, trouble-free service. Small nicks on the propeller, particularly near the tips and on the leading edges, should be dressed out as soon as possible since these nicks produce stress concentrations, and if ignored, may result in cracks. Never use an alkaline cleaner on the blades; remove grease and dirt with Stoddard solvent.

LANDING GEAR CARE

Cessna Dealer's mechanics have been trained in the proper adjustment and rigging procedures on the airplane hydraulic system. To assure trouble-free gear operation, have your Cessna Dealer check the gear regularly and make any necessary adjustments. Only properly trained mechanics should attempt to repair or adjust the landing gear.

ENGINE CARE

The engine may be cleaned with Stoddard solvent, or equivalent, then dried thoroughly.

CAUTION

Particular care should be given to electrical equipment before cleaning. Cleaning fluids should not be allowed to enter magnetos, starter, alternator and the like. Protect

these components before saturating the engine with solvents. All other openings should also be covered before cleaning the engine assembly. Caustic cleaning solutions should be used cautiously and should always be properly neutralized after their use.

INTERIOR CARE

To remove dust and loose dirt from the upholstery and carpet, clean the interior regularly with a vacuum cleaner.

Blot up any spilled liquid promptly with cleansing tissue or rags. Don't pat the spot; press the blotting material firmly and hold it for several seconds. Continue blotting until no more liquid is taken up. Scrape off sticky materials with a dull knife, then spot-clean the area.

Oily spots may be cleaned with household spot removers, used sparingly. Before using any solvent, read the instructions on the container and test it on an obscure place on the fabric to be cleaned. Never saturate the fabric with a volatile solvent; it may damage the padding and backing materials.

Soiled upholstery and carpet may be cleaned with foam-type detergent, used according to the manufacturer's instructions. To minimize wetting the fabric, keep the foam as dry as possible and remove it with a vacuum cleaner.

If your airplane is equipped with leather seating, cleaning of the seats is accomplished using a soft cloth or sponge dipped in mild soap suds. The soap suds, used sparingly, will remove traces of dirt and grease. The soap should be removed with a clean damp cloth.

The plastic trim, headliner, instrument panel and control knobs need only be wiped off with a damp cloth. Oil and grease on the control wheel and control knobs can be removed with a cloth moistened with Stoddard solvent. Volatile solvents, such as mentioned in paragraphs on care of the windshield, must never be used since they soften and craze the plastic.

SECTION 9 SUPPLEMENTS

(Optional Systems Description & Operating Procedures)

TABLE OF CONTENTS

Introduction

General:

1	Air Conditioning System	6 pages)
2	Carburetor Air Temperature Gage	(2 pages)
3	Convenience Table	(2 pages)
4	Digital Clock	(4 pages)
5	Electric Elevator Trim System	(4 pages)
6	Ground Service Plug Receptacle	(4 pages)
7	Oxygen System	(6 pages)
8	Strobe Light System	(2 pages)
9	Winterization Kit	(2 pages)

Avionics:

10	Audio Control Panels	(8 pages)
11	Cassette Stereo AM/FM Entertainment Center (Type EC-100)	(8 pages)
12	DME (Type 190)	(4 pages)
13	DME (Type 451)	(4 pages)
14	Emergency Locator Transmitter (ELT)	(4 pages)
15	Foster Area Navigation System (Type 511)	(8 pages)
16	RNAV (Type ANS-351C)	(14 pages)
16A	Slaved Horizontal Situation Indicator (Type IG-832A)	(4 pages)
17	SSB HF Transceiver (Type ASB-125)	(4 pages)
18	Unslaved Horizontal Situation Indicator (Type IG-832C)	(6 pages)
19	200A Navomatic Autopilot (Type AF-295B)	(6 pages)
20	300 ADF (Type R-546E)	(6 pages)
21	300 Nav/Com (Type RT-385A)	(8 pages)
22	300 Nav/Com (Type RT-385A) With 400 Area Navigation System (Type RN-478A)	(8 pages)
23	300 Transponder (Type RT-359A) And Optional Altitude Encoder (Blind) With Optional IDENT Switch	(6 pages)

TABLE OF CONTENTS (Continued)

24	300 Transponder (Type RT-359A) And Optional Encoding Altimeter (Type EA-401A) With Optional IDENT Switch	(6 pages)
25	300A Navomatic Autopilot (Type AF-395A)	(8 pages)
26	400 ADF (Type R-446A)	(6 pages)
27	400 Area Navigation System (Type RN-478A)	(6 pages)
28	400 DME (Type R-476A)	(4 pages)
29	400 Glide Slope (Type R-443B)	(4 pages)
30	400 Marker Beacon (Type R-402A)	(6 pages)
31	400 Nav/Com (Type RT-485A)	(10 pages)
32	400 Nav/Com (Type RT-485A) With 400 Area Navigation System (Type RN-478A)	(10 pages)
33	400 Transponder (Type RT-459A) And Optional Altitude Encoder (Blind) With Optional IDENT Switch	(6 pages)
34	400 Transponder (Type RT-459A) And Optional Encoding Altimeter (Type EA-401A) With Optional IDENT Switch	(6 pages)
35	400B Navomatic Autopilot (Type AF-550A)	(14 pages)

INTRODUCTION

This section consists of a series of supplements, each covering a single optional system which may be installed in the airplane. Each supplement contains a brief description, and when applicable, operating limitations, emergency and normal procedures, and performance. As listed in the Table of Contents, the supplements are classified under the headings of General and Avionics, and have been provided with reference numbers. Also the supplements are arranged alphabetically and numerically to make it easier to locate a particular supplement. Other routinely installed items of optional equipment, whose function and operational procedures do not require detailed instructions, are discussed in Section 7.

Limitations contained in the following supplements are FAA approved. Observance of these operating limitations is required by Federal Aviation Regulations.

SUPPLEMENT

AIR CONDITIONING SYSTEM

SECTION 1

GENERAL

The air conditioning system provides cooled air to the cabin during hot weather operations, both on the ground or in flight. Controls for the air conditioning system consist of two rotary switches, labeled A/C and FAN, located on the lower right switch and control panel beneath the standard cabin heating and ventilating controls. Rotating the A/C switch from OFF to the LOW position starts the system compressor. With continued clockwise rotation from LOW to MAX, progressively cooler air is provided to the cabin by cycling compressor operation. With the MAX position selected, the compressor runs continuously. Airflow is controlled by the knob labeled FAN. The control rotates clockwise from OFF through three positions labeled LOW, MED, and HI to provide three blower speeds. Cool air is directed through ducts above the headliner to four individually adjustable outlets, one above each seat. System electrical protection is provided by a 10-amp circuit breaker, labeled FAN, and a 15-amp circuit breaker, labeled A/C, located on the avionics circuit breaker panel on the left cabin sidewall.

In this system (see figure 1), a belt-driven compressor and a high pressure switch are located on the left front side of the engine, while the evaporator, condenser, blowers and other components are combined into an integral unit located above the main landing gear wheel well, aft of the baggage compartment wall. Removal of the left and center grills on the aft baggage compartment wall provides access to the Schrader valves and the receiver/dryer sight glass for servicing.

SECTION 2

LIMITATIONS

The air conditioning system must not be operated during takeoff and

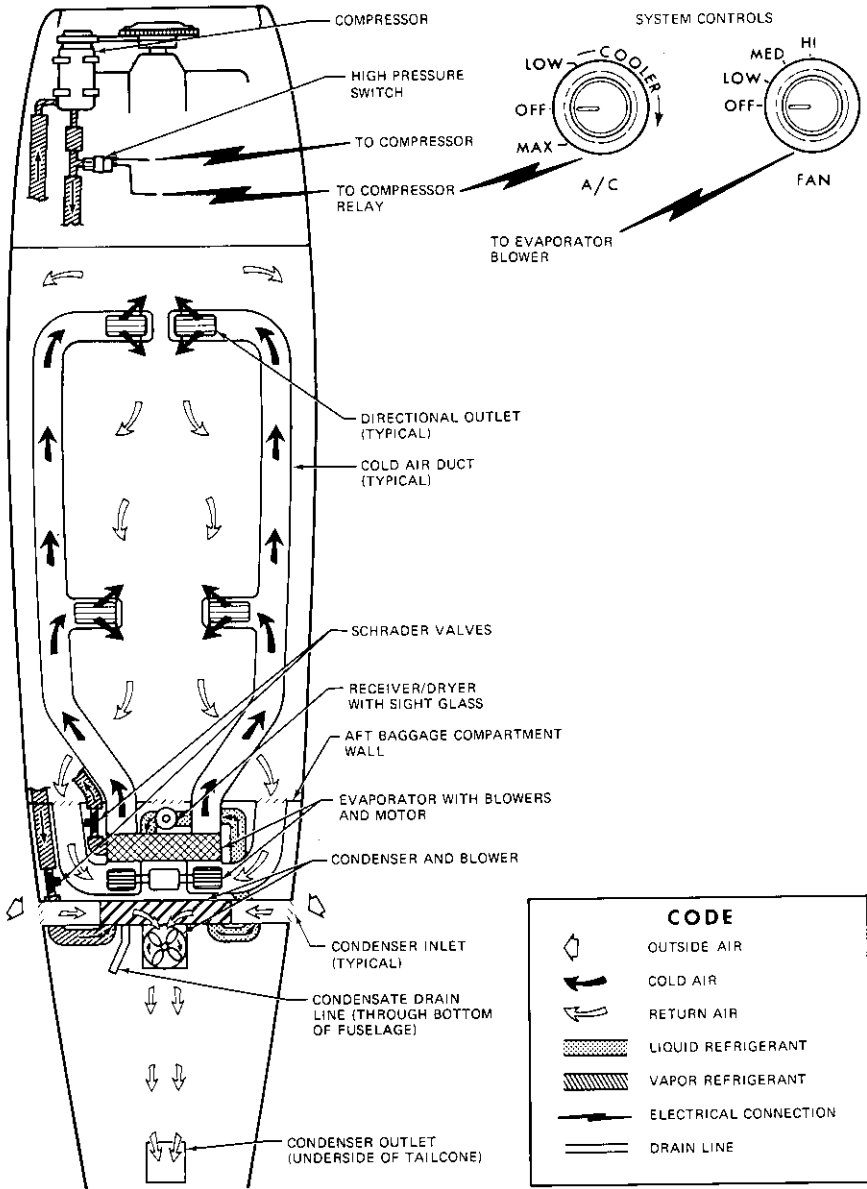

Figure 1. Air Conditioning System

landing. When the system is installed, the airplane must be equipped with a placard located in clear view of the pilot which reads as follows:

**TURN OFF AIR CONDITIONER
FOR TAKEOFF AND LANDING**

When the air conditioning system is installed, system components located behind the rear baggage compartment wall will obstruct access to the emergency locator transmitter (ELT) referenced on a placard on the baggage wall. Access to the ELT can be gained by removing the screws securing the large access panel on the right side of the tailcone.

SECTION 3 EMERGENCY PROCEDURES

There is no change to the airplane emergency procedures when the air conditioning system is installed.

SECTION 4 NORMAL PROCEDURES

PREFLIGHT INSPECTION

During the preflight (walk around) inspection, open both cabin doors to aid in cool-down of the cabin before flight. Air conditioning system components should be inspected as follows:

1. Check compressor condition and drive belt for tightness.
2. Check hoses (where visibility permits) from compressor to the condenser/evaporator unit for evidence of damage or leakage.
3. Check condenser inlets on each side of the tailcone and condenser outlet on underside of aft tailcone for condition and blockage.
4. Check that condensate drain on underside of fuselage beneath baggage compartment is not damaged or blocked.
5. Check that cabin return air openings (grills) in aft baggage compartment wall are clean and not blocked by baggage.

OPERATION ON GROUND

After preflight inspection and engine start, use the following procedures for quickest reduction of hot cabin temperatures prior to takeoff:

1. Cabin Doors and Windows -- CLOSED.
2. Cabin Air Control -- PUSHED IN.
3. Wing Root and Overhead Ventilators -- CLOSED.
4. A/C Control Switch -- MAX.
5. FAN Control Switch -- HI.

NOTE

A high pressure switch in the air conditioning system disengages the compressor clutch and stops system operation in the event the system becomes overheated during periods of idling at low RPM. The system will cycle on and off under these circumstances and is not malfunctioning. If this occurs, head the airplane into the wind and increase engine RPM, if practical.

BEFORE TAKEOFF

1. A/C Control Switch -- OFF.
2. FAN Control Switch -- AS DESIRED.

OPERATION IN FLIGHT

Initially, it may be desirable to operate the system at its coldest setting and highest blower speed for fast cool down. Later in the flight, adjustment of the controls to reduced settings may be necessary.

During extended flight when temperature and humidity are extremely high, the evaporator coils may frost over. The evaporator unit is equipped with an automatic defrost system which will normally prevent this. However, when the temperature (A/C) control is at its coldest setting (MAX), the automatic defrost system will not operate. Therefore, if the system no longer supplies enough cooling, move the temperature control counterclockwise slightly toward the OFF position and select the HI position of the FAN control. This should increase evaporator discharge temperature sufficiently to clear the frost.

The blower portion of the system may be used anytime air circulation is desired. This is accomplished by leaving the A/C switch in the OFF position and placing the FAN control switch in the LOW, MED, or HI position as desired.

BEFORE LANDING

1. A/C Control Switch -- OFF.
2. FAN Control Switch -- AS DESIRED.

AFTER LANDING

The A/C control switch may be rotated from OFF to a position which will provide cooled air to the cabin while operating on the ground.

SECTION 5 PERFORMANCE

The installation and operation of the air conditioning system will result in a minor (less than 1 knot) reduction in cruise performance.

DEMONSTRATED OPERATING TEMPERATURE

Satisfactory engine cooling has been demonstrated for the airplane with this equipment installed with an outside air temperature 23°C above standard. This is not to be considered as an operating limitation. Reference should be made to Section 2 of the basic handbook for engine operating limitations.

SUPPLEMENT

CARBURETOR AIR TEMPERATURE GAGE

SECTION 1 GENERAL

The carburetor air temperature gage provides a means of detecting carburetor icing conditions. The gage is located on the left side of the instrument panel below the gyros. It is marked in 5° increments from -30°C to +30°C, and has a yellow arc between -15°C and +5°C which indicates the temperature range most conducive to carburetor icing.

SECTION 2 LIMITATIONS

There is no change to the airplane limitations when the carburetor air temperature gage is installed.

SECTION 3 EMERGENCY PROCEDURES

There is no change to the airplane emergency procedures when the carburetor air temperature gage is installed.

SECTION 4 NORMAL PROCEDURES

There is no change to the airplane normal procedures when the carburetor air temperature gage is installed. It is good practice to monitor the gage periodically and keep the needle out of the yellow arc during possible carburetor icing conditions. Refer to Section 4 of the basic

handbook for procedures used when operating with carburetor heat applied.

SECTION 5

PERFORMANCE

There is no change to the airplane performance when the carburetor air temperature gage is installed. However, if it is necessary to operate with carburetor heat applied, a small performance loss may be expected at any given power setting due to the warmer induction air temperature.

SUPPLEMENT

CONVENIENCE TABLE

SECTION 1

GENERAL

The convenience table and its stowage compartment are installed on the back of the pilot's or copilot's seats for use by the second row passengers. The table is equipped with guides which follow tracks inside the stowage compartment.

SECTION 2

LIMITATIONS

The following information must be presented in the form of a placard located on the back of the convenience table.

**STOW LEAF DURING
TAKEOFF AND LANDING**

SECTION 3

EMERGENCY PROCEDURES

There is no change to the airplane emergency procedures when the convenience table is installed.

SECTION 4

NORMAL PROCEDURES

To remove the table from the stowage compartment, grasp the handle near the top edge of the leaf, slide it upward and aft until the leaf contacts the stops at the top of the compartment. Stowing the table is accomplished by rotating it upward and sliding it back down into the stowage compartment.

SECTION 5

PERFORMANCE

There is no change to the airplane performance when the convenience table is installed.

SUPPLEMENT

DIGITAL CLOCK

SECTION 1 GENERAL

The Astro Tech LC-2 Quartz Chronometer (see figure 1) is a precision, solid state time keeping device which will display to the pilot the time-of-day, the calendar date, and the elapsed time interval between a series of selected events, such as in-flight check points or legs of a cross-country flight, etc. These three modes of operation function independently and can be alternately selected for viewing on the four digit liquid crystal display (LCD) on the front face of the instrument. Three push button type switches directly below the display control all time keeping functions. These control functions are summarized in figures 2 and 3.

The digital display features an internal light (back light) to ensure good visibility under low cabin lighting conditions or at night. The intensity of the back light is controlled by the ENG-RADIO lights rheostat. In addition, the display incorporates a test function (see figure 1) which allows checking that all elements of the display are operating. To activate the test function, press the LH and RH buttons at the same time.

SECTION 2 LIMITATIONS

There is no change to the airplane limitations when the digital clock is installed.

SECTION 3 EMERGENCY PROCEDURES

There is no change to the airplane emergency procedures when the digital clock is installed.

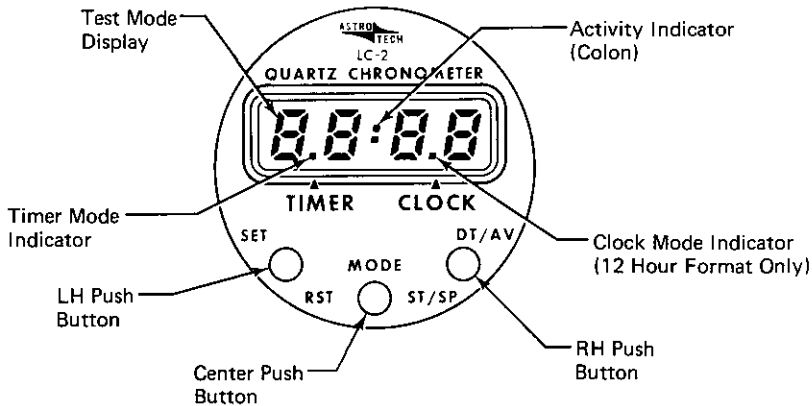

Figure 1. Digital Clock

SECTION 4

NORMAL PROCEDURES

CLOCK AND DATE OPERATION

When operating in the clock mode (see figure 2), the display shows the time of day in hours and minutes while the activity indicator (colon) will blink off for one second each ten seconds to indicate proper functioning. If the RH push button is pressed momentarily, while in the clock mode, the calendar date appears numerically on the display with month of year to the left of the colon and day of the month shown to the right of the colon. The display automatically returns to the clock mode after approximately 1.5 seconds. However, if the RH button is pressed continuously longer than approximately two seconds, the display will return from the date to the clock mode with the activity indicator (colon) blinking altered to show continuously or be blanked completely from the display. Should this occur, simply press the RH button again for two seconds or longer, and correct colon blinking will be restored.

NOTE

The clock mode is set at the factory to operate in the 24-hour format. However, 12-hour format operation may be selected by changing the position of an internal slide switch accessible through a small hole on the bottom of the instrument case. Notice that in the 24-hour format, the clock mode indicator does not appear.

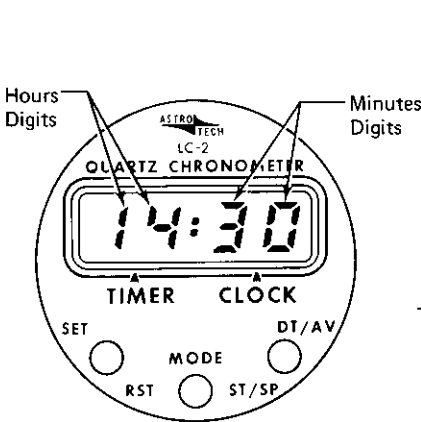

LH Button: Sets date and time of day (when used with RH button).

Center Button: Alternately displays clock or timer status

RH Button: Shows calendar date momentarily; display returns to clock mode after 1.5 seconds.

Figure 2. Clock Mode

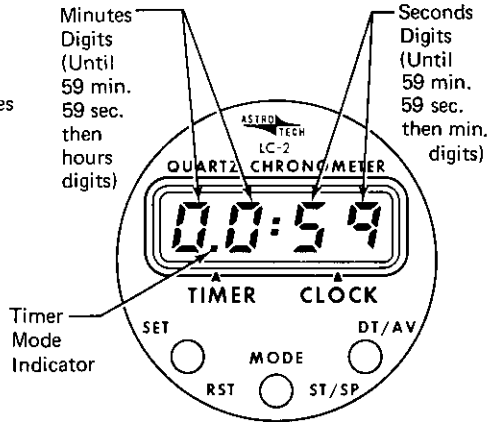

LH Button: Resets timer to "zero".

Center Button: Alternately displays clock or timer status

RH Button: Alternately starts and stops timer; timer starts from any previously accumulated total.

Figure 3. Timer Mode

SETTING CORRECT DATE AND TIME

The correct date and time are set while in the clock mode using the LH and RH push buttons as follows: press the LH button once to cause the date to appear with the month flashing. Press the RH button to cause the month to advance at one per second (holding button), or one per push until the correct month appears. Push the LH button again to cause the day of month to appear flashing, then advance as before using RH button until correct day of month appears.

Once set correctly, the date advances automatically at midnight each day. February 29 of each leap year is not programmed into the calendar mode, and the date will advance to March 1. This may be corrected the following day by resetting the mode back to March 1.

Pressing the LH button two additional times will cause the time to appear with the hours digits flashing. Using the RH button as before, advance the hour digits to the correct hour as referenced to a known time standard. Another push of the LH button will now cause the minutes digits to flash. Advance the minutes digits to the next whole minute to be reached by the time standard and "hold" the display by pressing the LH button once more. At the exact instant the time standard reaches the value "held" by the display, press the RH button to restart normal clock timing, which will now be synchronized to the time standard.

In some instances, however, it may not be necessary to advance the minutes digits of the clock; for example when changing time zones. In such a case, do not advance the minutes digits while they are flashing. Instead, press the LH button again, and the clock returns to the normal time keeping mode without altering the minutes timing.

TIMER OPERATION

The completely independent 24-hour elapsed timer (see figure 3) is operated as follows: press the center (MODE) push button until the timer mode indicator appears. Reset the display to "zero" by pressing the LH button. Begin timing an event by pressing the RH button. The timer will begin counting in minutes and seconds and the colon (activity indicator) will blink off for 1/10 second each second. When 59 minutes 59 seconds have accumulated, the timer changes to count in hours and minutes up to a maximum of 23 hours, 59 minutes. During the count in hours and minutes, the colon blinks off for one second each ten seconds. To stop timing the event, press the RH button once again and the time shown by the display is "frozen". Successive pushes of the RH button will alternately restart the count from the "held" total or stop the count at a new total. The hold status of the timer can be recognized by lack of colon activity, either continuously on or continuously off. The timer can be reset to "zero" at anytime using the LH button.

SECTION 5 PERFORMANCE

There is no change to the airplane performance when the digital clock is installed.

SUPPLEMENT

ELECTRIC ELEVATOR TRIM SYSTEM

SECTION 1 GENERAL

The electric elevator trim system provides a simple method of relieving pitch control pressures without interrupting other control operations to adjust the elevator trim wheel. The system is controlled by a dual-segmented, 3-position trim switch with each segment labeled DN and UP, a red momentary push button autopilot disengage/trim disconnect switch labeled AP/TRIM DISC, and a "pull-off" type circuit breaker, labeled ELEC TRIM. The dual segmented trim switch and push button autopilot disengage/trim disconnect switch are located on the left control wheel grip; the "pull-off" circuit breaker is on the left side of the switch and control panel. Simultaneously pushing the dual segments of the trim switch forward to the DN position moves the elevator trim tab and the trim wheel in the "nose down" direction; conversely, pulling the dual segments aft to the UP position moves the tab and trim wheel in the "nose up" direction. The dual segments of the trim switch are spring-loaded to automatically return to the center off position when they are released from the DN or UP positions, thus stopping movement of the trim tab and elevator trim wheel.

During normal operation of the electric elevator trim system, a trim actuator (which includes an electric motor, a solenoid gear engage mechanism, and an override slip clutch) moves the trim tab to the selected position. When the dual segments of the trim switch are in the center off position, the trim actuator is disconnected from the trim system and does not impede manual adjustment of the trim tab by the elevator trim wheel.

SECTION 2 LIMITATIONS

Prior to each flight during which the electric elevator trim system will be used, a preflight check of the system safety features must be made as discussed in the Normal Procedures section of this supplement.

SECTION 3

EMERGENCY PROCEDURES

1. Elevator Control -- **OVERPOWER** as required.
2. **AP/TRIM DISC** Push Button -- **PUSH** and **RELEASE**.
3. **ELEC TRIM** Circuit Breaker -- **PULL OFF** for the remainder of the flight.
4. **Manual Trim** -- **AS REQUIRED**.

SECTION 4

NORMAL PROCEDURES

BEFORE TAKEOFF

The following electric trim system checks must be made prior to each flight:

1. Each Individual Segment of Electric Trim Switch -- **PUSH FORWARD** to **DN** position and **HOLD** momentarily, **RELEASE** to center off position. **PULL AFT** to **UP** position and **HOLD** momentarily, **RELEASE** to center off position.
2. Elevator Trim Wheel -- **OBSERVE NO MOVEMENT** of the trim wheel as trim switch segments are individually cycled through **DN** and **UP** positions.

NOTE

If movement of the elevator trim wheel is noted during checks of steps 1 and 2, the electric elevator trim system has malfunctioned. The flight may be continued if the electric trim circuit breaker is pulled to the off position to render the system inoperative until such time as repairs can be made.

3. Both Segments of Electric Trim Switch -- **PUSH FORWARD SIMULTANEOUSLY** and **HOLD**. During "nose down" cycle of elevator trim wheel, **DEPRESS** and **RELEASE AP/TRIM DISC** push button.
4. Elevator Trim Wheel -- **OBSERVE MOVEMENT** in proper direction. After **AP/TRIM DISC** push button is depressed and released, **OBSERVE NO MOVEMENT**.

5. Both Segments of Electric Trim Switch -- REPEAT step 3 in opposite direction.
6. Elevator Trim Wheel -- REPEAT step 4 in opposite direction.
7. Both Segments of Electric Trim Switch -- RELEASE TO CENTER OFF POSITION to reactivate system.

NOTE

During the preceding steps verify movement of elevator trim tab in proper direction.

NOTE

If movement of the elevator trim wheel is observed after the AP/TRIM DISC push button is depressed and released during steps 3, 4, 5, or 6, the elevator trim system has malfunctioned. The ELEC TRIM circuit breaker should be pulled to the off position to render the system inoperative.

INFLIGHT

To operate the electric elevator trim system during flight, proceed as follows:

1. Master Switch -- ON.
2. Elevator Trim Circuit Breaker -- PUSH-TO-RESET, if off.
3. Dual Segmented Trim Switch -- ACTUATE as desired.
4. Electric Trim Position Indicator -- CHECK.

SECTION 5

PERFORMANCE

There is no change to the airplane performance when the electric elevator trim system is installed.

SUPPLEMENT

GROUND SERVICE PLUG RECEPTACLE

SECTION 1 GENERAL

The ground service plug receptacle permits the use of an external power source for cold weather starting and during lengthy maintenance work on the electrical and avionics equipment. The receptacle is located behind a door on the fuselage tailcone aft of the baggage compartment door.

NOTE

If no avionics equipment is to be used or worked on, the avionics power switch should be turned off. If maintenance is required on the avionics equipment, it is advisable to utilize a battery cart external power source to prevent damage to the avionics equipment by transient voltage. Do not crank or start the engine with the avionics power switch turned on.

A special fused circuit is included with the ground service plug receptacle which will close the battery contactor when external power is applied with the master switch turned on. This circuit is intended as a servicing aid when battery power is too low to close the contactor, and should not be used to avoid performing proper maintenance procedures on a low battery.

NOTE

Use of the ground service plug receptacle for starting an airplane with a "dead" battery or charging a "dead" battery in the airplane is not recommended. The battery should be removed from the airplane and serviced in accordance with Service Manual procedures. Failure to observe this precaution could result in loss of electrical power during flight.

The ground service plug receptacle circuit incorporates a polarity reversal protection. Power from the external power source will flow only if the ground service plug is correctly connected to the airplane. If the plug is accidentally connected backwards, no power will flow to the electrical system, thereby preventing any damage to electrical equipment.

The following check should be made after engine start and removal of the external power source, if there is any question as to the condition of the battery.

1. Master Switch -- OFF.
2. Taxi and Landing Light Switches -- ON.
3. Engine RPM -- REDUCE to idle.
4. Master Switch -- ON (with taxi and landing lights turned on).
5. Engine RPM -- INCREASE to approximately 1500 RPM.
6. Ammeter and Low-Voltage Warning Light -- CHECK.

NOTE

If the ammeter does not show a charge or the low-voltage warning light does not go out, the battery should be removed from the airplane and properly serviced prior to flight.

SECTION 5 PERFORMANCE

There is no change to the airplane performance when the ground service plug receptacle is installed.

SUPPLEMENT

OXYGEN SYSTEM

SECTION 1

GENERAL

A four-place oxygen system provides the supplementary oxygen necessary for continuous flight at high altitude. In this system, an oxygen cylinder, located behind the rear baggage compartment wall, supplies the oxygen. Cylinder pressure is reduced to an operating pressure of 70 psi by a pressure regulator attached to the cylinder. A shutoff valve is included as part of the regulator assembly. An oxygen cylinder filler valve is located under a cover plate on the fuselage tailcone aft of the baggage compartment door. Cylinder pressure is indicated by a pressure gage located in the overhead oxygen console.

Four oxygen outlets are provided; two in the overhead oxygen console and two in the cabin ceiling just above the side windows, one at each of the seating positions. One permanent, microphone-equipped mask is provided for the pilot, and three disposable type masks are provided for the passengers. All masks are the partial-rebreathing type equipped with vinyl plastic hoses and flow indicators.

NOTE

The hose provided for the pilot is of a higher flow rate than those for the passengers; it is color-coded with an orange band adjacent to the plug-in fitting. The passenger hoses are color-coded with a green band. If the airplane owner prefers, he may provide higher flow hoses for all passengers. In any case, it is recommended that the pilot use the larger capacity hose. The pilot's mask is equipped with a microphone to facilitate use of the radio while using oxygen. An adapter cord is furnished with the microphone-equipped mask to mate the mask microphone lead to the auxiliary microphone jack located on the left side of the instrument panel. To connect the oxygen mask microphone, connect the mask lead to the adapter cord and plug the cord into the auxiliary microphone jack. (If an optional microphone-headset combination has been in use, the microphone lead from this equipment is already plugged into the auxiliary microphone jack. It will be necessary to disconnect this lead from the auxiliary microphone jack so that the adapter cord from the oxygen

mask microphone can be plugged into the jack). A switch is incorporated on the left hand control wheel to operate the microphone.

A remote shutoff valve control, located adjacent to the pilot's oxygen outlet, is used to shut off the supply of oxygen to the system when not in use. The control is mechanically connected to the shutoff valve at the cylinder. With the exception of the shutoff function, the system is completely automatic and requires no manual regulation for change of altitude.

The oxygen cylinder, when fully charged, contains approximately 48 cubic feet of oxygen, under a pressure of 1800 psi at 70°F (21°C). Filling pressures will vary, however, due to the ambient temperature in the filling area, and because of the temperature rise resulting from compression of the oxygen. Because of this, merely filling to 1800 psi will not result in a properly filled cylinder. Fill to the pressures indicated in figure 1 for ambient temperature.

WARNING

Oil, grease or other lubricants in contact with oxygen create a serious fire hazard, and such contact must be avoided when handling oxygen equipment.

AMBIENT TEMPERATURE °F	FILLING PRESSURE PSIG	AMBIENT TEMPERATURE °F	FILLING PRESSURE PSIG
0	1600	50	1825
10	1650	60	1875
20	1700	70	1925
30	1725	80	1975
40	1775	90	2000

Figure 1. Oxygen Filling Pressures

OXYGEN DURATION CHART (48 CUBIC FEET CAPACITY)

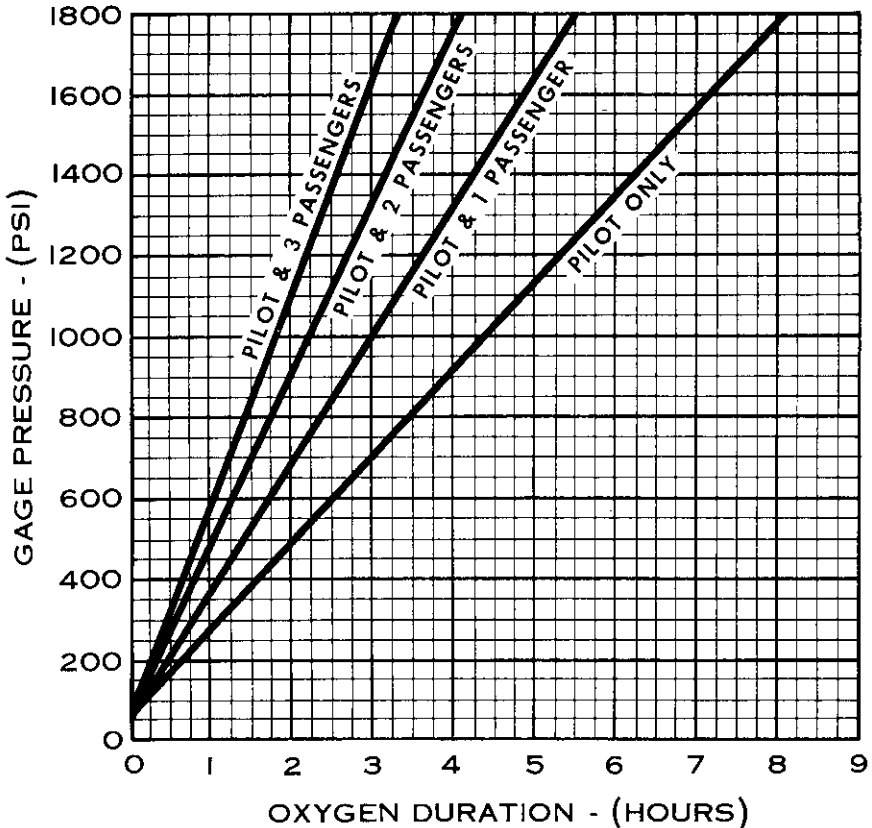

NOTE: This chart is based on a pilot with an orange color-coded oxygen line fitting and passengers with green color-coded line fittings.

Figure 2. Oxygen Duration Chart

For FAA requirements concerning supplemental oxygen, refer to FAR 91.32. Supplemental oxygen should be used by all occupants when cruising above 12,500 feet. As described in the Cessna booklet "Man At Altitude," it is often advisable to use oxygen at altitudes lower than 12,500 feet under conditions of night flying, fatigue, or periods of physiological or emotional disturbances. Also, the habitual and excessive use of tobacco or alcohol will usually necessitate the use of oxygen at less than 10,000 feet.

The Oxygen Duration Chart (figure 2) should be used in determining the usable duration (in hours) of the oxygen supply in your airplane. The following procedure outlines the method of finding the duration from the chart.

1. Note the available oxygen pressure shown on the pressure gage.
2. Locate this pressure on the scale on the left side of the chart, then go across the chart horizontally to the right until you intersect the line representing the number of persons making the flight. After intersecting the line, drop down vertically to the bottom of the chart and read the duration in hours given on the scale.
3. As an example of the above procedure, 1400 psi of pressure will safely sustain the pilot only for nearly 6 hours and 15 minutes. The same pressure will sustain the pilot and three passengers for approximately 2 hours and 30 minutes.

NOTE

The Oxygen Duration Chart is based on a standard configuration oxygen system having one orange color-coded hose assembly for the pilot and green color-coded hoses for the passengers. If orange color-coded hoses are provided for pilot and passengers, it will be necessary to compute new oxygen duration figures due to the greater consumption of oxygen with these hoses. This is accomplished by computing the total duration available to the pilot only (from PILOT ONLY line on chart), then dividing this duration by the number of persons (pilot and passengers) using oxygen.

SECTION 2 LIMITATIONS

There is no change to the airplane limitations when oxygen equipment is installed.

SECTION 3 EMERGENCY PROCEDURES

There is no change to the airplane emergency procedures when oxygen equipment is installed.

SECTION 4 NORMAL PROCEDURES

Prior to flight, check to be sure that there is an adequate oxygen supply for the trip, by noting the oxygen pressure gage reading, and referring to the Oxygen Duration Chart (figure 2). Also, check that the face masks and hoses are accessible and in good condition.

WARNING

For safety reasons, no smoking should be allowed in the airplane while oxygen is being used.

When ready to use the oxygen system, proceed as follows:

1. Mask and Hose -- SELECT. Adjust mask to face and adjust metallic nose strap for snug mask fit.
2. Delivery Hose -- PLUG INTO OUTLET nearest to the seat you are occupying.

NOTE

When the oxygen system is turned on, oxygen will flow continuously at the proper rate of flow for any altitude without any manual adjustments.

3. Oxygen Supply Control Knob -- ON.
4. Face Mask Hose Flow Indicator -- CHECK. Oxygen is flowing if the indicator is being forced toward the mask.
5. Delivery Hose -- UNPLUG from outlet when discontinuing use of oxygen. This automatically stops the flow of oxygen.
6. Oxygen Supply Control Knob -- OFF when oxygen is no longer required.

SECTION 5 PERFORMANCE

There is no change to the airplane performance when oxygen equipment is installed.

SUPPLEMENT

STROBE LIGHT SYSTEM

SECTION 1 GENERAL

The high intensity strobe light system enhances anti-collision protection for the airplane. The system consists of two wing tip-mounted strobe lights (with integral power supplies), a two-position rocker switch labeled STROBE LIGHTS, and a 5-amp "pull-off" type circuit breaker, labeled STROBE/AVN FAN. The rocker switch and circuit breaker are located on the left side of the switch and control panel.

SECTION 2 LIMITATIONS

Strobe lights must be turned off when taxiing in the vicinity of other airplanes, or during night flight through clouds, fog or haze.

SECTION 3 EMERGENCY PROCEDURES

There is no change to the airplane emergency procedures when strobe lights are installed.

SECTION 4 NORMAL PROCEDURES

To operate the strobe light system, proceed as follows:

1. Master Switch -- ON.
2. Strobe Light Switch -- ON.

SECTION 5

PERFORMANCE

The installation of strobe lights will result in a minor reduction in cruise performance.

SUPPLEMENT

WINTERIZATION KIT

SECTION 1 GENERAL

The winterization kit consists of two cover plates (with placards) which attach to the air intakes in the cowling nose cap, and a placard to be installed on the instrument panel. This equipment should be installed for operations in temperatures consistently below 20°F (-7°C).

SECTION 2 LIMITATIONS

The following information must be presented in the form of placards when the airplane is equipped with a winterization kit.

1. On each nose cap cover plate:

THIS PLATE NOT TO BE USED WHEN
TEMPERATURE EXCEEDS +20° F.

2. On right side of instrument panel:

WINTERIZATION KIT MUST BE REMOVED
WHEN OUTSIDE AIR TEMPERATURE IS
ABOVE 20°F.

SECTION 3

EMERGENCY PROCEDURES

There is no change to the airplane emergency procedures when the winterization kit is installed.

SECTION 4

NORMAL PROCEDURES

There is no change to the airplane normal procedures when the winterization kit is installed.

SECTION 5

PERFORMANCE

There is no significant change to the airplane performance when the winterization kit is installed.

SUPPLEMENT

AUDIO CONTROL PANELS

SECTION 1

GENERAL

Two types of audio control panels (see figure 1) are available for this airplane, depending upon how many transmitters are included. The operational features of both audio control panels are similar and are discussed in the following paragraphs.

TRANSMITTER SELECTOR SWITCH

When the avionics package includes a maximum of two transmitters, a two-position toggle-type switch, labeled XMTR, is provided to switch the microphone to the transmitter the pilot desires to use. If the airplane avionics package includes a third transmitter, the transmitter selector switch is a three-position rotary-type switch, labeled XMTR SEL. To select a transmitter, place the transmitter selector switch in the position number corresponding to the desired transmitter.

The action of selecting a particular transmitter using the transmitter selector switch simultaneously selects the audio amplifier associated with that transmitter to provide speaker audio. For example, if the number one transmitter is selected, the audio amplifier in the number one NAV/COM is also selected and is used for ALL speaker audio. Headset audio is not affected by audio amplifier operation.

AUDIO SELECTOR SWITCHES

Both audio control panels (see figure 1) incorporate three-position toggle-type audio selector switches for individual control of the audio systems installed in the airplane. These switches allow receiver audio to be directed to the airplane speaker or to a headset, and heard singly or in combination with other receivers. To hear a particular receiver on the airplane speaker, place that receiver's audio selector switch in the up (SPEAKER) position. To listen to a receiver over a headset, place that receiver's audio selector switch in the down (PHONE) position. The center (OFF) position turns off all audio from the associated receiver.

NOTE

Volume level is adjusted using the individual receiver volume controls on each radio.

A special feature of the audio control panel used when one or two transmitters are installed is separate control of NAV and COM audio from the NAV/COM radios. With this installation, the audio selector switches labeled NAV, 1 and 2 select audio from the navigation receivers of the NAV/COM radios only. Communication receiver audio is selected by the switches labeled COM, AUTO and BOTH. Description and operation of these switches is described in figure 1.

When the audio control panel for three transmitters is installed, audio from both NAV and COM frequencies is combined, and is selected by the audio selector switches labeled NAV/COM, 1, 2 and 3.

COM AUTO AUDIO SELECTOR SWITCH

The audio control panel used with either one or two transmitters incorporates a three-position toggle switch, labeled COM AUTO, which is provided to automatically match the audio of the appropriate NAV/COM communications receiver to the radio selected by the transmitter selector switch.

COM BOTH AUDIO SELECTOR SWITCH

The audio control panel used with either one or two transmitters incorporates a three-position toggle switch, labeled COM BOTH, which is provided to allow both COM receivers to be monitored at the same time.

AUTO AUDIO SELECTOR SWITCH

The audio control panel used with three transmitters incorporates a three-position toggle switch, labeled AUTO, which is provided to automatically match the audio of the appropriate NAV/COM receiver to the selected transmitter.

ANNUNCIATOR LIGHTS BRIGHTNESS AND TEST SWITCH

The audio control panel used with either one or two transmitters incorporates a three-position toggle switch with NITE (up) and DAY (middle) positions to control the brightness level of the marker beacon indicator lights, and the BC and RN Nav indicator lights (when installed). In the TEST (down) position, all annunciator lights (Mkr Bcn, BC and RN) will illuminate full bright to verify lighting test.

NOTE

A potentiometer is installed inside the audio control panel to provide further minimum light dimming capabilities. Refer to the appropriate Avionics Service/Parts manual for adjustment procedures.

SIDETONE OPERATION

Cessna radios are equipped with sidetone capability (monitoring of the operator's own voice transmission). While adjusting speaker sidetone, be aware that if the sidetone volume level is set too high, audio feedback (squeal) may result when transmitting.

When the airplane has one or two transmitters, sidetone is provided in either the speaker or headset anytime the COM AUTO selector switch is utilized. Placing the COM AUTO selector switch in the OFF position will eliminate sidetone. Sidetone internal adjustments are available to the pilot through the front of the audio control panel (see figure 1).

When the airplane has three transmitters, sidetone will be heard on either the speaker or a headset as selected with the AUTO selector switch. Sidetone may be eliminated by placing the AUTO selector switch in the OFF position, and utilizing the individual audio selector switches. Adjustment of speaker and headset sidetone volume can only be accomplished by adjusting the sidetone potentiometers located inside the audio control panel.

NOTE

Sidetone is not available on HF Transceiver (Type ASB-125), when installed.

OPTIONAL INTERCOM SYSTEM

The optional intercom system is a pilot and copilot intercom phone system which is only offered with the one and two transmitter type audio control panel. The system incorporates its own audio amplifier with a volume control (labeled INT) and a "hot mike" feature. The intercom system is used with the headphones only.

The "hot mike" feature allows the pilot and copilot to communicate at anytime through their microphone/headsets without having to key the mike. However, they must key the mike button on their control wheel to transmit over the aircraft's transceiver. Sidetone is present on the intercom system when the AUTO switch is in the PHONE position.

NOTE

Any ambient noise attenuating type padded headset and boom mike combination is not compatible with this system.

The intercom audio volume is controlled by the INT knob located on the front of the audio control panel. Clockwise rotation of the knob increases the volume of the intercom audio and counterclockwise rotation decreases it. The INT knob controls the audio volume for the intercom system only. Receiver audio volume is adjusted using the individual receiver volume controls. When the intercom system is not being used, the volume control should be turned full counterclockwise to eliminate any noise over the headphones.

NOTE

When the intercom volume is turned up and an auxiliary mike is plugged in, there will be a loud squeal over the speaker if the COM BOTH and COM AUTO switches are inadvertently placed in the opposite positions (one in the SPEAKER position and the other in the PHONE position). To eliminate this squeal turn the volume down or place both switches in the same position.

When the optional intercom system is not installed, a plug button will be installed in place of the INT volume control knob.

USED WITH ONE OR TWO TRANSMITTERS

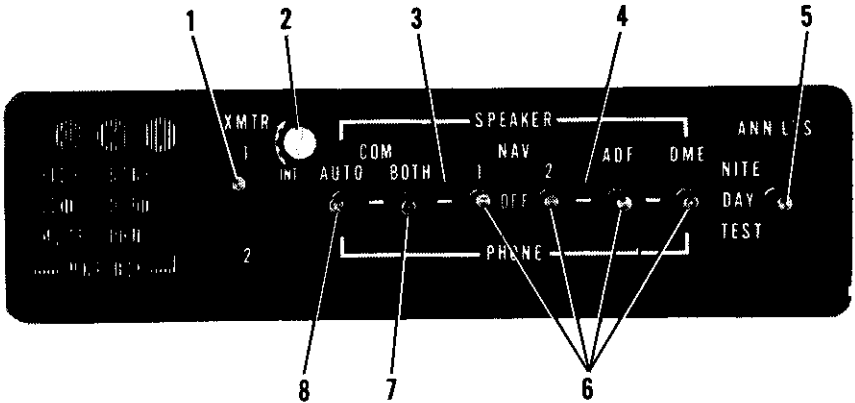

USED WITH THREE TRANSMITTERS OR DUAL ADF'S

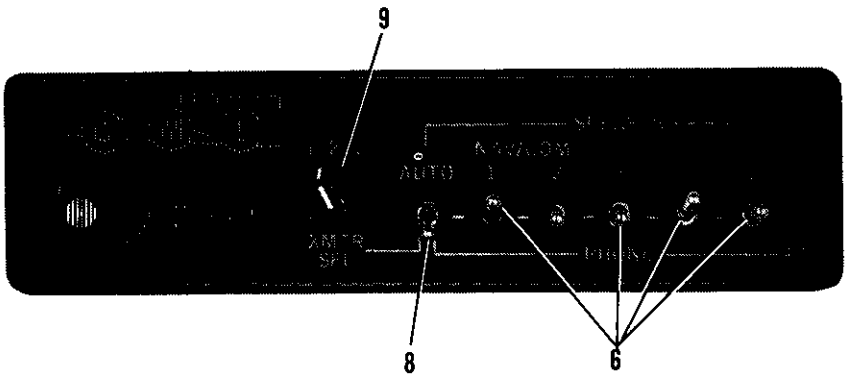

1. TRANSMITTER SELECTOR SWITCH (XMTR) - A two-position toggle switch used to activate the audio amplifier and switch the microphone to the desired transmitter. The number 1 (up position) and 2 (down position) corresponds to the first and second (from top to bottom) transmitters, respectively.

Figure 1. Audio Control Panel Operating Controls
(Sheet 1 of 2)

2. INTERCOM VOLUME CONTROL (INT) - Controls the intercom audio volume. Clockwise rotation of the knob increases the intercom audio volume and counterclockwise rotation decreases it.
3. HEADSET SIDETONE INTERNAL ADJUSTMENT ACCESS - To adjust headset sidetone, remove the plug button, place COM AUTO selector switch in the PHONE position, insert a small screwdriver into the adjustment potentiometer and rotate it clockwise to increase the sidetone volume or counterclockwise to decrease sidetone.
4. SPEAKER SIDETONE INTERNAL ADJUSTMENT ACCESS - To adjust speaker sidetone, remove the plug button, place COM AUTO selector switch in the SPEAKER position, insert a small screwdriver into the adjustment potentiometer and rotate it clockwise to increase the sidetone volume or counterclockwise to decrease sidetone. While adjusting sidetone, be aware that if the sidetone volume level is set too high, audio feedback (squeal) may result when transmitting.
5. ANNUNCIATOR LIGHTS BRIGHTNESS SELECTOR AND TEST SWITCH (ANN LTS-NITE/DAY/TEST) - Three-position toggle switch; in the up (NITE) position, annunciator lights (Mkr Bcn, BC and RN) will show at a reduced light level for typical night operations. In the center (DAY) position, annunciator lights (Mkr Bcn, BC and RN) will show full bright to verify lamp operation. In the NITE position, annunciator light (Mkr Bcn, BC and RN) level can be further adjusted down to a preset minimum using the RADIO LT dimming rheostat knob.
6. AUDIO SELECTOR SWITCHES - Three-position selector switches used to select either SPEAKER or PHONE operation for audio outputs. Enables the operator to select any one or more, audio signals on either SPEAKER or PHONE at the same time or to silence audio when placed in the OFF position.
7. COMBOTH AUDIO SELECTOR SWITCH (COM BOTH) - A three-position toggle switch used to allow both COM receivers to be monitored at the same time. Placing the COM BOTH switch in the up (SPEAKER) position will enable the pilot to monitor both the number 1 and number 2 COM receivers over the SPEAKER at the same time. Placing the switch in the down (PHONE) position allows the pilot to monitor both the number 1 and number 2 COM receivers through the headset at the same time. Center (OFF) position, removes the non-selected COM receiver (or both COM receivers if COM AUTO switch is OFF) from the audio system.
8. COM AUTO AUDIO SELECTOR SWITCH (COM AUTO OR AUTO) - A three-position toggle switch provided to automatically match the audio of the appropriate NAV/COM communications receiver to the transmitter selected by the transmitter selector switch. In the up (SPEAKER) position, audio from the selected receiver will be heard on the airplane speaker. In the down (PHONE) position, audio from the selected receiver will be heard through the headset. Center (OFF) position, removes the automatic SPEAKER/PHONE selection feature and will also disable the sidetone feature.
9. TRANSMITTER SELECTOR SWITCH (XMTR SEL) - A three-position rotary switch used to activate the audio amplifier and switch the microphone to the desired transmitter. The numbers 1, 2 and 3 positions correspond to the first, second and third (from top to bottom) transmitters, respectively.

Figure 1. Audio Control Panel Operating Controls
(Sheet 2 of 2)

SECTION 2 LIMITATIONS

There is no change to the airplane limitations when either of these audio control panels is installed.

SECTION 3 EMERGENCY PROCEDURES

In the event the audio amplifier in use fails, as evidenced by loss of all speaker audio, selecting an alternate transmitter will reestablish speaker audio using the alternate transmitter audio amplifier.

SECTION 4 NORMAL PROCEDURES

AUDIO CONTROL PANEL OPERATIONS:

1. Transmitter Selector (XMTR or XMTR SEL) Switch -- SELECT desired transmitter for transceiver operation.
2. COM AUTO or AUTO Selector Switch -- SELECT SPEAKER or PHONE position to automatically select SPEAKER or PHONE audio.

NOTE

If the NAV/COM audio selector switch corresponding to the selected transmitter is in the PHONE position with the AUTO selector switch in the SPEAKER position, all audio selector switches placed in the PHONE position will automatically be connected to both the airplane speaker and any headsets in use.

3. COM BOTH Selector Switch -- SELECT the same SPEAKER or PHONE position which was set on the COM AUTO selector switch to allow both COM receivers to be monitored at the same time.

NOTE

The combination of placing the COM AUTO switch in the SPEAKER position and the COM BOTH switch in the PHONE position (or vice versa) is not normally recommended as it will cause audio from both communications receivers (and any other navigation receiver with its audio selector switch in the PHONE position) to be heard on both the airplane speaker and the headset simultaneously.

4. Audio SPEAKER/PHONE Selector Switches -- SELECT desired SPEAKER or PHONE audio position only if COM AUTO switch is not used.
5. INT Control Knob -- ROTATE as desired to increase or decrease intercom audio volume.
6. ANN LTS Switch:
 - a. TEST Position -- SELECT to verify operation of marker beacon, BC and RN annunciator lights (when installed).
 - b. DAY Position -- SELECT for typical daytime lighting.
 - c. NITE Position -- SELECT for typical night lighting.

NOTE

In the NITE position, further lighting adjustment for the Mkr Bcn, BC and RN (when installed) annunciator lights can be obtained using the RADIO LT dimming rheostat knob.

SECTION 5

PERFORMANCE

There is no change to the airplane performance when either of these audio control panels is installed.

SUPPLEMENT

CASSETTE STEREO AM/FM ENTERTAINMENT CENTER

(Type EC-100)

SECTION 1

GENERAL

The EC-100 Cassette Stereo Player and AM/FM Radio is a compact, fully automatic AM/FM Mpx radio and stereo cassette player mounted in the instrument panel above the glove box, or in the alternate location utilizing the glove box. In addition to the player/radio, the system consists of stereo headphones and an externally mounted, fixed-wire antenna. All operating controls for the player/radio and headphones are shown and described in figure 1.

The AM/FM Mpx Radio will receive AM frequencies between 525 and 1650 kHz or FM frequencies between 88 and 108 MHz. AM or FM reception is selected by an AM/FM pushbutton located on the front of the set and with strong FM stations, at altitude, the radio can receive FM stations for over 200 miles.

The cassette stereo player is equipped with four-track, two-channel stereo cassette type playback with a tape speed of 4.76 cm/sec. Any standard-size monaural or stereo cassette may be used in the player. Cassettes are automatically activated when inserted in cassette receptacle (with tape play side to the right) with radio ON and AM/FM switch in either AM or FM position. When cassette is removed, radio play will automatically resume. Annunciator lights will illuminate monitoring the STEREO, TAPE, or COM Interrupt modes.

A COM Interrupt mode in this system, when activated, will interrupt stereo and cassette audio to provide selected aircraft radio audio to the stereo headphones. After a short delay, preselected stereo or cassette play will return following the completion of the aircraft communications.

A COM ONLY mode in the EC-100, allows the pilot to eliminate all entertainment modes and activate uninterrupted navigation and communications audio.

Headphones are equipped with individual earphone volume controls and a phone plug which must be attached to one of the phone jacks mounted overhead. Stereo phone jacks are placarded either "STEREO" or "STEREO HEADPHONE".

NOTICE

Sound from the player/radio is only available through stereo headphones.

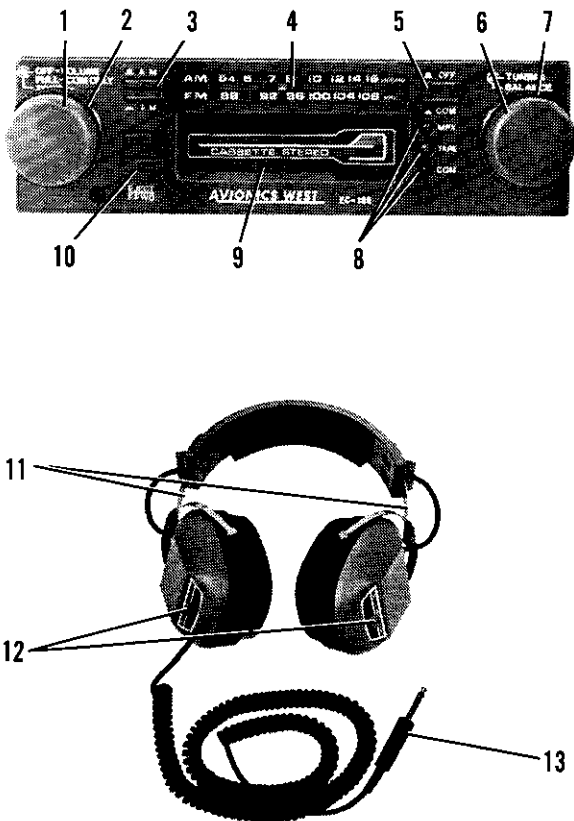

Figure 1. Cassette Stereo AM/FM Entertainment Center, Operating Controls. (Sheet 1 of 3)

1. OFF/VOLUME AND PULL-COM ONLY CONTROL KNOB:

OFF-VOLUME CONTROL - Turning knob fully counterclockwise to detent turns off entire system. Advancing the knob clockwise past the detent, applies power to the unit. Advancing it further clockwise increases the volume of audio level.

NOTE

This control affects the audio level of both the radio/tape system as well as the communications audio.

PULL-COM ONLY - Pull out on this knob to eliminate all entertainment modes and enable the NAV/COM input only.

2. RADIO/PLAYER AND COM TONE CONTROL (TONE) - Normal position of this control is fully clockwise for flat audio response. If excessive high frequency hiss is evident in the headphones, the control may be rotated counterclockwise to reduce the high frequency response.
3. AM/FM PUSHBUTTON SELECTOR SWITCH (AM/FM) - Selects AM or FM radio reception; IN for FM and OUT for AM.
4. AM and FM RADIO FREQUENCY INDICATOR DIAL (AM/FM) - Indicates selected operating radio frequencies for AM between 525 and 1650 kHz and FM between 88 and 108 MHz.
5. COM INTERRUPT PUSHBUTTON SELECTOR SWITCH (OFF/COM) - To activate the communications override feature, pushbutton is pushed in. Communications override is eliminated by pushing button completely in and releasing (button out).
6. TUNING SELECTOR CONTROL KNOB (TUNING) - Rotate to tune in desired AM or FM operating frequencies.
7. RADIO/PLAYER AND COM SPEAKER BALANCE CONTROL KNOB (BALANCE) - Left and right speaker balance is controlled by counterclockwise and clockwise rotation of control knob.
8. MODE ANNUNCIATOR LIGHTS:

MPX (GREEN) - Illuminates green to indicate that a stereo FM station has been tuned-in.

TAPE (AMBER):

Dim Position - Illuminates dim amber to indicate tape mode of operation.

Bright Position - Illuminates bright amber to indicate cassette has reached end of tape and requires changing.

COM (RED) - Illuminates red to indicate com mode has been activated and a com transmission is being received.

9. CASSETTE RECEPTACLE - Insert cassette cartridge, turned sideways, with tape play side to the right. When the cartridge is inserted far enough, the mechanism will snap it into place and the EJECT pushbutton will move to the extended

Figure 1. Cassette Stereo AM/FM Entertainment Center, Operating Controls. (Sheet 2 of 3)

position (button out). Top numbered side will play. Either monaural or standard stereo cassettes may be used.

10. TAPE EJECT AND FAST FORWARD PUSHBUTTON (EJECT/F. FWD) - This pushbutton has two modes of control. For fast forward (rewind), pushbutton is pushed in slightly. Cassette is ejected when button is pushed completely in.
11. HEADPHONE EXTENSION-ADJUSTMENT ARMS - Located on both sides of the headphones. Earphone extension is adjusted by sliding the adjustment arms in, or out, of the head pad to a comfortable listening position.
12. EARPHONE VOLUME CONTROL LEVERS - Regulates volume of audio to individual earphones. Volume increases as levers are moved to higher settings.
13. HEADPHONE PLUG - Inserts into one of the phone jacks located overhead and placarded "STEREO" or "STEREO HEADPHONE". Jacks are for 1/4-inch stereo plugs only.

CAUTION

To prevent damage to the entertainment center, use only 8-ohm headphones with 1/4-inch stereo type plugs.

Figure 1. Cassette Stereo AM/FM Entertainment Center, Operating Controls. (Sheet 3 of 3)

SECTION 2 LIMITATIONS

There is no change to the airplane limitations when this avionics equipment is installed.

SECTION 3 EMERGENCY PROCEDURES

There is no change to the airplane emergency procedures when this avionics equipment is installed.

SECTION 4 NORMAL PROCEDURES

AM/FM RADIO OPERATIONS:

1. Headphones -- INSERT headphone plug(s) into jack(s) mounted

- overhead and placarded either "STEREO" or "STEREO HEADPHONE".
2. Earphone Volume Control Levers -- SELECT a position slightly lower than medium volume for both volume control levers on the headphones.
 3. Headphone Extension-Adjustment Arms -- ADJUST to comfortable listening position.
 4. OFF/VOLUME AND PULL-COM ONLY CONTROL KNOB -- ROTATE control knob clockwise past detent to activate unit. Continue to rotate knob clockwise to desired volume setting.

NOTE

Audio can only be heard through stereo headphones.

CAUTION

The stall and gear warning horn may not be heard with the stereo headphones in use.

With headphones plugged in, extended play at full volume should be avoided in order to prevent damage to headphones and hearing.

5. AM/FM Pushbutton Selector Switch -- SELECT as desired; IN for FM, OUT for AM.
6. TUNING Knob -- SELECT desired frequency.
7. MPX Stereo Annunciator Light -- CHECK ON (green light will illuminate) if FM radio station reception is selected.
8. Earphone Volume Control Levers -- ADJUST to desired audio setting. Volume is increased by moving levers to HI settings, and lowered by moving levers to LO settings.

NOTE

Improper tuning will result in poor tone and excessive noise.

9. TONE Control -- ROTATE to a fully clockwise position for normal operation.

NOTE

If excessive high frequency hiss is evident in the head-

phones, the control may be rotated counterclockwise to reduce the high frequency response.

10. BALANCE Control -- ADJUST to desired audio setting.

CASSETTE PLAYER OPERATIONS:

1. Tape Receptacle -- INSERT CASSETTE with tape play side to right and adjust listening controls on unit and headphones. Player will play top numbered side.

NOTE

When tape is ejected, radio play will automatically resume.

2. TAPE Annunciator Light -- CHECK ON; Light will illuminate dim amber when cassette is installed and will illuminate bright amber when cassette has reached end of tape play and requires changing.

CAUTION

To insure the best performance and operation of your cassette player, follow these simple rules:

- a. Loose cassette tape should not be played. If your tape is loose, rewind it before playing.
- b. Do not keep cassette tape in your player long after cassette play is finished.
- c. Do not use non-standard cassette tapes. Damage to your player will result.
3. Tape EJECT/Fast Forward Pushbutton:
 - a. To Eject Tape -- PUSH IN button all the way to eject cassette at end of play or at any point desired.
 - b. To Select Fast Forward (Rewind) -- PUSH SLIGHTLY in for fast forward position (push button in approximately half way).
 - c. To Cancel Fast Forward -- RELEASE BUTTON.

COM INTERRUPT OPERATIONS:

NOTE

Aircraft radio(s) must be turned on and the desired audio, to be monitored by COM Interrupt, must have the associated receiver's SPEAKER/PHONE selector switch(es) placed in the PHONE position on the audio control panel in order for the COM Interrupt feature to be operational. Audio signals that the pilot does not want to monitor, by the COM Interrupt feature, must have their associated receiver's SPEAKER/PHONE selector switch(es) on the audio control panel placed in the OFF position.

1. AM/FM Radio/Cassette Player -- SELECT and TURN ON desired system to be operated.
2. VOL Control -- SET to desired listening level.

NOTES

This control affects the stereo headphone audio level of the radio/tape system and other aircraft radios selected.

If the audio level from the Nav/Com Radio is too weak getting to the entertainment center, the COM Interrupt circuit will not be activated. If the audio level is too strong, distortion will be produced in the audio signal.

3. Com Interrupt Pushbutton Selector Switch (on EC-100) -- PUSH button in halfway and release to activate COM Interrupt circuit.
4. Aircraft's COM Radio SQ Control -- ROTATE clockwise until background noise is noticable and note that the red (COM) annunciator illuminates on the EC-100 to verify COM Interrupt operation, and then, backoff slightly on the SQ Control until background noise disappears. Repeat this operation periodically in normal flight.

COM ONLY OPERATIONS:

1. PULL-COM ONLY Selector Knob -- PULL knob out to override all audio modes in the EC-100 and activate audio signals as selected by the PHONE switches on the audio control panel.
2. COM Annunciator Light -- CHECK ON (Red) when selected audio is being received.

SECTION 5

PERFORMANCE

There is no change to the airplanes performance when this avionics equipment is installed. However, the installation of an externally mounted antenna or several related external antennas will result in a minor reduction in cruise performance.

SUPPLEMENT

DME

(TYPE 190)

SECTION 1

GENERAL

The DME 190 (Distance Measuring Equipment) system consists of a panel mounted 200 channel UHF transmitter-receiver and an externally mounted antenna. The transceiver has a single selector knob that changes the DME's mode of operation to provide the pilot with: distance-to-station, time-to-station, or ground speed readouts. The DME is designed to operate at altitudes up to a maximum of 50,000 feet at ground speeds up to 250 knots and has a maximum slant range of 199.9 nautical miles.

The DME can be channeled independently or by a remote NAV set. When coupled with a remote NAV 1 set, the MHz digits will be covered over by a remote (REM) flag and the DME will utilize the frequency set by the NAV set's channeling knobs. When the DME is not coupled with a remote NAV set, the DME will reflect the channel selected on the DME unit. The transmitter operates in the frequency range of 1041 to 1150 MHz and is paired with 108 to 117.95 MHz to provide automatic DME channeling. The receiver operates in the frequency range of 978 to 1213 MHz and is paired with 108 to 117.95 MHz to provide automatic DME channeling.

All operating controls (except for a SPEAKER/PHONE selector switch mounted on the audio control panel supplied with one or two transmitters as described in another supplement in this section) for the DME are mounted on the front panel of the DME and are described in Figure 1.

SECTION 2

LIMITATIONS

There is no change to the airplane limitations when this avionic equipment is installed.

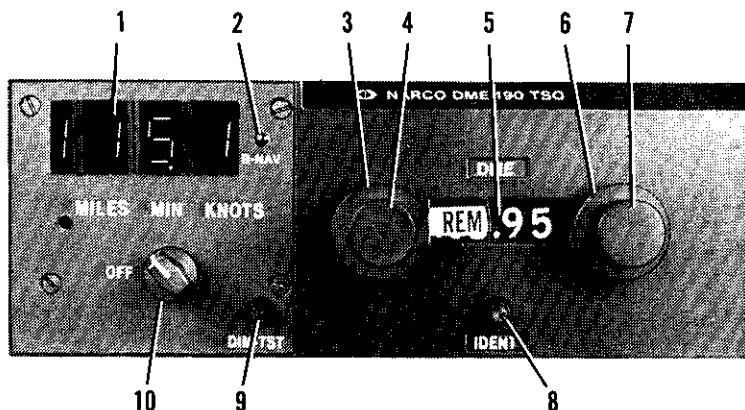

1. READOUT WINDOW - Displays function readout in nautical miles (distance-to-station), minutes (time-to-station) or knots (ground speed).
2. R-NAV INDICATOR LAMP - The green R-NAV indicator lamp is provided to indicate the DME is coupled to an R-NAV system. Since this DME 190 is only factory installed with an R-NAV 511 system on Cessna airplanes, the R-NAV indicator lamp will never be illuminated. However, if a compatible R-NAV system is coupled to the DME, and when in R-NAV mode, the R-NAV lamp will light which indicates that the distance readout is the "way point" instead of the DME station. The DME can only give distance (MILES) in R-Nav mode.
3. REMOTE CHANNELING SELECTOR - Two position selector. In the first position, the DME will utilize the frequency set by the DME channeling knobs. In the second position, the MHz digits will utilize the frequency set by the NAV 1 unit's channeling knobs.
4. WHOLE MEGAHERTZ SELECTOR KNOB - Selects operating frequency in 1-MHz steps between 108 and 117 MHz.
5. FREQUENCY INDICATOR - Shows operating frequency selected on the DME or displays remote (REM) flag to indicate DME is operating on a frequency selected by the remote NAV 1 receiver.
6. FRACTIONAL MEGAHERTZ SELECTOR KNOB - Selects operating frequency in 50 kHz steps. This knob has two positions, one for the 0 and one for the 5.
7. FRACTIONAL MEGAHERTZ SELECTOR KNOB - Selects operating frequency in tenths of a Megahertz (0-9).

Figure 1. DME 190 Operating Controls (Sheet 1 of 2)

8. IDENT KNOB - Rotation of this control increases or decreases the volume of the received station's Ident signal. An erratic display, accompanied by the presence of two Ident signals, can result if the airplane is flying in an area where two stations using the same frequency are transmitting.

9. DIM-TST KNOB -
 - DIM: Controls the brilliance of the readout lamp's segments. Rotate the control as desired for proper lamp illumination in the function window (The frequency window is dimmed by the aircraft's radio light dimming control).

 - TST (PUSH TEST): This control is used to test the illumination of the readout lamps, with or without being tuned to a station. Press the control, a readout of 1888 should be seen with the mode selector switch in the MIN or KNOTS position. The decimal point along with 188.8 will light in the MILES mode. When the control is released, and had the DME been channeled to a nearby station, the distance to that station will appear. If the station channeled was not in range, a "bar" readout will be seen (--- or ---).

10. MODE SELECTOR SWITCH -
 - OFF: Turns the DME OFF.
 - MILES: Allows a digital readout to appear in the window which represents slant range (in nautical miles) to or from the channeled station.
 - MIN: Allows a digital readout (in minutes) to appear in the window that it will take the airplane to travel the distance to the channeled station. This time is only accurate when flying directly TO the station and after the ground speed has stabilized.
 - KNOTS: Allows a digital readout (in knots) to appear in the window that is ground speed and is valid only after the stabilization time (approximately 2 minutes) has elapsed when flying directly TO or FROM the channeled station.

Figure 1. DME 190 Operating Controls (Sheet 2 of 2)

SECTION 3

EMERGENCY PROCEDURES

There is no change to the airplane emergency procedures when this avionic equipment is installed.

SECTION 4

NORMAL PROCEDURES

TO OPERATE:

1. Mode Selector Switch -- SELECT desired DME function.
2. Frequency Selector Knobs -- SELECT desired frequency and allow equipment to warm-up at least 2 minutes.

NOTE

If remote channeling selector is set in REM position, select the desired frequency on the #1 Nav radio.

3. PUSH TEST Control -- PUSH and observe reading of 188.8 in function window.
4. DIM Control -- ADJUST.
5. DME SPEAKER/PHONE Selector Switch (on audio control panel) -- SELECT as desired.
6. IDENT CONTROL -- ADJUST audio output in speaker or headset.
7. Mode Selector Functions:
 - MILES Position -- Distance-to-Station is slant range in nautical miles.
 - MIN Position -- Time-to-Station when flying directly to station.
 - KNOTS Position -- Ground Speed in knots when flying directly to or from station.

CAUTION

After the DME 190 has been turned OFF, do not turn it on again for 5 seconds to allow the protective circuits to reset.

SECTION 5

PERFORMANCE

There is no change to the airplane performance when this avionic equipment is installed. However, the installation of an externally mounted antenna or several related external antennas, will result in a minor reduction in cruise performance.

SUPPLEMENT

DME

(TYPE 451 WITH IND-450C INDICATOR)

SECTION 1 GENERAL

The DME-451 system consists of a panel-mounted IND-450C Indicator, a remotely-mounted TCR-451 Transceiver and an externally-mounted antenna.

Except for selection of the operating channel, which is selected by the VHF navigation receiver frequency selector switches, the DME-451 system is capable of independent operation. The DME-451 transmits interrogating pulse pairs on 200 channels between 1041 MHz and 1150 MHz; it receives associated ground-to-air replies between 978 MHz and 1213 MHz. The IND-450C digitally displays distances to or from the selected station up to 200 nautical miles, aircraft ground speed from 30 to 399 knots, or time-to-station with a maximum time of 120 minutes. A Nav mode selector switch provides selection of ON/OFF, Nav 1, Nav 2, Hold and RNAV operation. A DME display selector switch provides selection of distance to or from station (NM), aircraft ground speed (KTS) or time-to-station (MIN). An ambient light sensor automatically controls brightness of digital display and annunciators.

SECTION 2 LIMITATIONS

There is no change to the airplane limitations when this avionic equipment is installed.

SECTION 3 EMERGENCY PROCEDURES

There is no change to the airplane emergency procedures when this avionic equipment is installed.

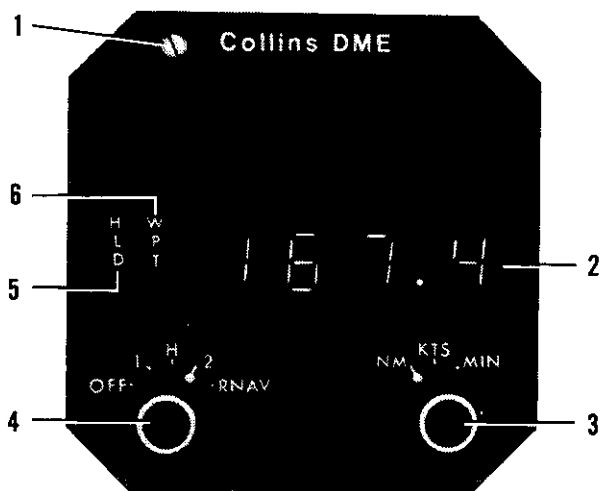

1. AMBIENT LIGHT SENSOR - Senses ambient cockpit light and controls brightness of digital display and WPT and HLD annunciators.
2. DIGITAL DISPLAY - Displays distance to or from station (NM), aircraft ground speed (KTS), or time-to-station (MIN), depending on the position of the display selector (3).

NOTE

Dashes will be observed on the display until station lock-on occurs in the NM mode or until a velocity of at least 30 knots is established with lock-on in the KTS or MIN mode.

NOTE

In all DME modes except RNAV, aircraft ground speed and time-to-station are meaningful only when the aircraft track is directly to or from the ground station. The KTS and MIN indications require approximately 1.5 minutes after station acquisition for final accuracy.

3. DME DISPLAY SELECTOR SWITCH - Selects desired mode readouts as follows:
NM Position: Displays distance to or from the selected station in nautical miles up to 199.9 nmi.
KTS Position: Displays aircraft ground speed up to 399 knots.
MIN Position: Displays time-to-station with a maximum time of 120 minutes.

Brightness of this switch is controlled by the radio light dimming rheostat.

Figure 1. IND-450C Indicator
(Sheet 1 of 2)

4. NAV MODE SELECTOR SWITCH - Applies power to the DME and selects DME operating modes as follows:
 - OFF: Turns the DME OFF.
 - NAV 1: Selects DME operation with No. 1 VHF navigation set; enables channel selection by Nav 1 frequency selector switches.
 - HOLD: Selects DME memory circuit; DME remains channeled to station to which it was last channeled when HOLD was selected and will continue to display information relative to this channel. Allows both the Nav 1 and Nav 2 navigation receivers to be set to new operational frequencies without affecting the previously selected DME operation.

CAUTION

In the Hold mode there is no annunciation of the VOR/DME station frequency. However, an annunciator labeled "HLD" will illuminate on the DME to flag the pilot that the DME is in the Hold mode.

NAV 2: Selects DME operation with No. 2 VHF navigation set; enables channel selection by Nav 2 frequency selector switches.
RNAV: Selects area navigation operation.

Brightness of this switch is controlled by the radio light dimming rheostat.

5. HOLD ANNUNCIATOR (HLD) - Illuminates amber to indicate HOLD mode is selected.
6. WAYPOINT ANNUNCIATOR (WPT) - Illuminates amber to indicate RNAV mode is selected. (Annunciator will not illuminate when DME is installed without RNAV.)

Figure 1. IND-450C Indicator
(Sheet 2 of 2)

SECTION 4

NORMAL PROCEDURES

DME OPERATION

1. NAV 1 and NAV 2 VHF Navigation Receivers -- ON; SET frequency selector switches to VOR/DME station frequencies as required.
2. NAV Mode Selector Switch -- SET to NAV 1 or NAV 2.

NOTE

When the VOR frequency is selected, the appropriate DME frequency is automatically channeled.

3. DME SPEAKER/PHONE Selector Switch (on audio control panel) -- SET to desired mode to identify station ident tone.
4. DME Display Selector Switch -- SELECT desired readout.

DME HOLD FUNCTION:

The HOLD position is selected when the currently controlling Nav receiver (1 or 2) frequency is about to be changed but the pilot wishes the DME to remain operating on the current frequency after the navigation frequency has been changed.

1. NAV Mode Selector Switch -- SELECT HOLD.

CAUTION

Inadvertent switching to any other DME Nav Mode position other than HOLD must be avoided, since this could cause the DME to display erroneous information.

2. NAV 1 or NAV 2 Receiver -- SELECT new operating frequency.

SECTION 5

PERFORMANCE

There is no change to the airplane performance when this avionic equipment is installed. However, the installation of an externally-mounted antenna or several related external antennas, will result in a minor reduction in cruise performance.

SUPPLEMENT

EMERGENCY LOCATOR TRANSMITTER (ELT)

SECTION 1 GENERAL

The ELT consists of a self-contained dual-frequency radio transmitter and battery power supply, and is activated by an impact of 5g or more as may be experienced in a crash landing. The ELT emits an omni-directional signal on the international distress frequencies of 121.5 and 243.0 MHz. (Some ELT units in export aircraft transmit only on 121.5 MHz.) General aviation and commercial aircraft, the FAA, and CAP monitor 121.5 MHz, and 243.0 MHz is monitored by the military. Following a crash landing, the ELT will provide line-of-sight transmission up to 100 miles at 10,000 feet. The ELT supplied in domestic aircraft transmits on both distress frequencies simultaneously at 75 mw rated power output for 50 continuous hours in the temperature range of -4°F to +131°F (-20°C to +55°C). The ELT unit in export aircraft transmits on 121.5 MHz at 25 mw rated power output for 50 continuous hours in the temperature range of -4°F to +131°F (-20°C to +55°C).

The ELT is readily identified as a bright orange unit mounted behind the baggage compartment wall in the tailcone. To gain access to the unit, remove the baggage compartment wall. The ELT is operated by a control panel at the forward facing end of the unit (see figure 1).

SECTION 2 LIMITATIONS

The following information is presented in the form of a placard located on the baggage compartment wall.

EMERGENCY LOCATOR TRANSMITTER
INSTALLED AFT OF THIS PARTITION.
MUST BE SERVICED IN ACCORDANCE
WITH FAR PART 91.52

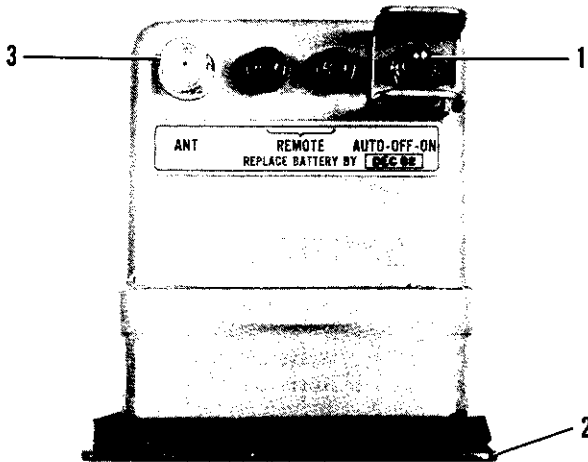

1. FUNCTION SELECTOR SWITCH (3-position toggle switch):
 - ON - Activates transmitter instantly. Used for test purposes and if "g" switch is inoperative.
 - OFF - Deactivates transmitter. Used during shipping, storage and following rescue.
 - AUTO - Activates transmitter only when "g" switch receives 5g or more impact.
2. COVER - Removable for access to battery pack.
3. ANTENNA RECEPTACLE - Connects to antenna mounted on top of tailcone.

Figure 1. ELT Control Panel

SECTION 3

EMERGENCY PROCEDURES

Immediately after a forced landing where emergency assistance is required, the ELT should be utilized as follows.

1. ENSURE ELT ACTIVATION --Turn a radio transceiver ON and select 121.5 MHz. If the ELT can be heard transmitting, it was activated by the "g" switch and is functioning properly. If no emergency tone is audible, gain access to the ELT and place the function selector switch in the ON position.

2. PRIOR TO SIGHTING RESCUE AIRCRAFT -- Conserve airplane battery. Do not activate radio transceiver.
3. AFTER SIGHTING RESCUE AIRCRAFT -- Place ELT function selector switch in the OFF position, preventing radio interference. Attempt contact with rescue aircraft with the radio transceiver set to a frequency of 121.5 MHz. If no contact is established, return the function selector switch to ON immediately.
4. FOLLOWING RESCUE -- Place ELT function selector switch in the OFF position, terminating emergency transmissions.

SECTION 4 NORMAL PROCEDURES

As long as the function selector switch remains in the AUTO position, the ELT automatically activates following an impact of 5g or more over a short period of time.

Following a lightning strike, or an exceptionally hard landing, the ELT may activate although no emergency exists. To check your ELT for inadvertent activation, select 121.5 MHz on your radio transceiver and listen for an emergency tone transmission. If the ELT can be heard transmitting, place the function selector switch in the OFF position and the tone should cease. Immediately place the function selector switch in the AUTO position to re-set the ELT for normal operation.

SECTION 5 PERFORMANCE

There is no change to the airplane performance data when this equipment is installed.

SUPPLEMENT

FOSTER AREA NAVIGATION SYSTEM (Type 511)

SECTION 1 GENERAL

The Foster Area Navigation System (RNAV - Type 511) consists of a 511 Area Nav Computer, a compatible VHF navigation receiver, a DME Adapter Module and DME.

The RNAV 511 is a basic Area Navigation Computer with two thumb-wheel programmable waypoints. It performs continuous computation of triangulation problems.

The VOR and DME equipment in the aircraft provides information to the computer on aircraft position relative to the VORTAC station. A waypoint is dialed into one set of waypoint thumbwheels by inserting the RADIAL and DISTANCE of the waypoint (the position the pilot would like to fly over, or to) relative to the VORTAC station. The RNAV 511 computer calculates the Magnetic Bearing (BEARING) and Distance (RANGE NM) from the aircraft to the waypoint repeatedly to provide continual information on WHICH WAY and HOW FAR to the waypoint.

The pilot can monitor BEARING and RANGE on RNAV 511 to fly straight line paths to waypoints up to 200 NM distance from the aircraft position. Waypoints can be precisely dialed into the thumbwheels to 0.1° and 0.1 NM resolution.

The RNAV 511 also provides immediate position orientation relative to the VORTAC (VOR/DME) station being used for computation. Merely press the VOR/DME pushbutton to display the RADIAL and DME distance from the VORTAC.

Another feature of the RNAV 511 is its ability to provide evidence of proper computation in the system. The system can be tested at anytime before flight or while airborne to confirm proper computer operation. An acceptable "test" is evidenced by the active waypoint's RADIAL/DISTANCE being displayed in the BEARING and RANGE windows of the RNAV 511 while TEST pushbutton is pressed. In addition to the "test" feature, diagnostic functions are provided to alert the pilot of why the system is not functional.

SECTION 2

LIMITATIONS

This RNAV installation is not approved for IFR operations and the following information is displayed on individual placards:

1. Adjacent to panel unit when used with the DME 190:

RNAV FOR VFR FLIGHT ONLY
TUNE DME & NAV 1 TO SAME
VORTAC FOR RNAV OPERATION

2. Adjacent to panel unit when used with the 400 DME:

RNAV FOR VFR FLIGHT ONLY
DME MODE SELECTOR ON
NAV 1 OR NAV 2 ONLY

SECTION 3

EMERGENCY PROCEDURES

There is no change to the airplane emergency procedures when this avionic equipment is installed.

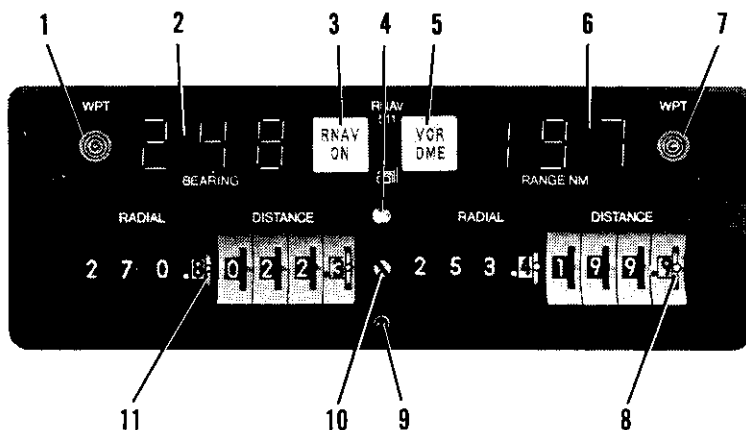

1. WAYPOINT PUSHBUTTON (WPT) - Activates the waypoint data dialed into the left side thumbwheels (11). When pressed, the WPT pushbutton lights to indicate which waypoint is "active". The WPT pushbutton light intensity is controlled by a photocell (4).
2. MAGNETIC BEARING DISPLAY READOUT - Digitally displays the magnetic bearing from the airplane to the waypoint. While VOR/DME pushbutton (5) is pressed, the digital display reads RADIAL from the VOR station on which the airplane is presently positioned.
3. RNAV ON/OFF PUSHBUTTON (RNAV ON) - When pressed, RNAV ON light will illuminate and set is turned ON. When pressed again, set will be turned OFF and the RNAV ON light will go out. The pushbutton lighting is automatically dimmed by the photocell (4).
4. PHOTOCELL - Senses ambient cockpit light and controls brightness of pushbuttons (1, 3, 5 & 7) and digital displays (2 & 6).
5. VOR DME PUSHBUTTON - Provides PRESENT POSITION information as to VOR RADIAL and DME DISTANCE digitally in positions (2) and (6) respectively when the pushbutton is pressed.
6. DISTANCE DISPLAY READOUT - Digitally displays airplane DISTANCE TO or FROM the waypoint. Reads by 0.1 NM increments up to 99.9 NM and by 1.0 NM increments over 100 NM. Maximum range readout is 199 NM. While VOR/DME pushbutton (5) is pressed, the digital display reads DME distance to the VORTAC station from the airplane.

Figure 1. Foster Area Nav (Type 511) Computer Operating Controls and Indicators (Sheet 1 of 2)

7. WAYPOINT PUSHBUTTON (WPT) - Activates the waypoint data dialed into the RIGHT side thumbwheels (8). When pressed, the WPT pushbutton lights to indicate which waypoint is "active". The WPT pushbutton light intensity is controlled by photocell (4).
8. RADIAL AND DISTANCE THUMBWHEELS - Waypoint location (RADIAL and DISTANCE) is dialed into thumbwheels to 0.1° and 0.1 NM resolution. Maximum waypoint offset from the VORTAC is 199.9 NM.
9. TEST PUSHBUTTON - Press to check proper calibration of RNAV 511. If the computer is properly calibrated, the displays (2 & 6) read the "active" WPT RADIAL and DISTANCE as dialed into the thumbwheels. CDI left/right needle will center and NAV/TO-FROM flag will display TO when the OBS setting is at the value of the RADIAL entered in the waypoint thumbwheels. Test may be performed anytime, (during or before flight).
10. LOCKING SCREW - Secures RNAV 511 in dustcover. Turn locking screw counterclockwise several turns to release unit from panel.
11. RADIAL AND DISTANCE THUMBWHEELS - Waypoint location (RADIAL AND DISTANCE) is dialed into thumbwheels to 0.1° and 0.1 NM resolution. Maximum waypoint offset from the VORTAC is 199.9 NM.

Figure 1. Foster Area Nav (Type 511) Computer Operating Controls and Indicators (Sheet 2 of 2)

SECTION 4

NORMAL OPERATION

VOR/LOC OPERATION

VOR NAVIGATION CIRCUITS VERIFICATION TESTS:

1. See appropriate Nav/Com supplement.

AREA NAVIGATION OPERATING NOTES

1. Proper RNAV operation requires valid VOR and DME inputs to the RNAV system. In certain areas, the ground station antenna patterns and transmitter power may be inadequate to provide valid signals to the RNAV. For this reason, intermittent RNAV signal loss may be experienced enroute.
2. When a waypoint from one VORTAC is displaced over a second VORTAC, interference from the second VORTAC sometimes causes erratic and unusable BEARING and RANGE displays on the RNAV at low altitude.
3. The RNAV BEARING readout (to the waypoint) becomes extremely sensitive and may become unusable within 1 - 1 1/2 miles of the waypoint. Thus, the RANGE readout is the primary means of approximating waypoint passage.
4. Tracking from a waypoint is not recommended since the pilot would have to fly a reciprocal bearing and make error corrections in the opposite direction from flying to a waypoint.

DIAGNOSTIC FUNCTIONS

All RNAV systems are rendered inoperative under certain conditions. The RNAV 511 provides a Flag mode and permits a diagnostic interpretation of why the system is inoperative.

FLAG MODE INDICATIONS:

1. Six "Bars" Appear in the Digital Displays (2 & 6):
 - a. PRESS VOR/DME button (5) to determine if the VOR radial signal is absent. If VOR radial signal is absent, bars will change to show as "000" in the BEARING window (2). (One possible cause of this condition could be that the NAV receiver is channeled to a localizer signal.)

- b. Excess RADIAL waypoint address entry (11 or 8) such as 360.1° or 389° -- The computer will not accept this entry.
- c. Excess RANGE to Waypoint (6) -- This would be any value over 199 NM. (A check of aircraft position relative to the VORTAC and Waypoint will detect and verify this condition.)
2. Missing DME Signal Display -- This will show as "00.0" in the RANGE NM digital display (6) when the VOR/DME button (2) is held in. The missing DME signal is then the reason for the FLAG condition. (If valid VOR and DME data is displayed, then another cause must be sought.)
3. Temporary Display of Unchanging Random Digits in the BEARING and RANGE Windows (2 & 6) at Time of Initial Turn-ON -- Such a condition is caused by a random interpretation of the micro processor cycle. The RNAV 511 will Flag this malfunction by a complete blanking of all display functions. The pilot can reset the micro processor cycle by turning the RNAV OFF and then ON.

WAYPOINT PROGRAMMING

1. Using a VFR Sectional or other appropriate maps -- DETERMINE distance and bearing for desired waypoint(s) from appropriate VOR/DME stations.
2. VHF Navigation Receiver -- ON (When installed with DME 190, RNAV 511 is connected to the Nav 1 Rcvr. When installed with the 400 DME, RNAV 511 may be connected to either the Nav 1 or Nav 2 Rcvr.) and channeled to the desired VORTAC.
3. DME ON/OFF Switch -- ON.
4. DME Remote Channeling Selector on DME 190 Selector -- SET to REM position on DME 190.
5. DME Mode Selector on 400 DME -- SET TO desired NAV 1 or NAV 2 position on 400 DME.

NOTE

RNAV and HOLD positions on the 400 DME Mode Selector are not used with this installation. RNAV is automatically channeled to the selected Nav receiver.

6. GS/TTS Selector Switch (on 400 DME) -- SET as desired. (Will only display **ground speed** component or **time-to-station** at that speed to the selected VOR --**not the waypoint.**)
7. RADIAL and DISTANCE Thumbwheels -- SET to first waypoint RADIAL and DISTANCE. (Typically, the first waypoint is set into the left side set of thumbwheels.)
8. RADIAL and DISTANCE Thumbwheels -- SET to second waypoint RADIAL and DISTANCE. (Typically, the second waypoint is set into the right set of thumbwheels.)

9. Left WPT Pushbutton Switch -- PUSH in.
 - a. First waypoint RADIAL and DISTANCE are placed in unit as a waypoint.
10. RNAV BEARING Readout -- OBSERVE readout for magnetic BEARING to waypoint.
11. RNAV RANGE Readout -- OBSERVE readout of first waypoint distance.
12. TEST Pushbutton -- PRESS and observe that the desired BEARING and RANGE readouts of the waypoint thumbwheel settings are displayed.
 - a. BEARING Display Readout -- DISPLAYS readout of first waypoint bearing.
 - b. RANGE Display Readout -- DISPLAYS readout of first waypoint distance.
 - c. COURSE DEVIATION INDICATOR (CDI) -- CDI needle centers and NAV/TO-FROM indicator displays TO if OBS setting is at the value of the radial entered in the waypoint thumbwheels.
13. DG or HSI -- CONTROL AIRCRAFT as required to maintain desired track to or from waypoint.

NOTE

Due to wind drift, it may be necessary to fly a few degrees plus or minus the calculated BEARING readout in order to maintain the desired BEARING readout on the computer.

14. VOR/DME Pushbutton -- PRESS at anytime to observe the radial and DME distance from the VORTAC associated with the waypoint.
15. Upon Waypoint Passage -- CHECK or SELECT next desired waypoint's VORTAC frequency on the selected Nav receiver and then PRESS next WPT Pushbutton in and repeat steps 9 through 12 to proceed to next waypoint which was dialed in the right set of thumbwheels.

NOTE

Waypoint passage will begin to be reflected on the RNAV BEARING display about 1.5 NM from the waypoint. Waypoint passage will be reflected by a rapid change of BEARING displays. Therefore, the pilot should fly the established inbound predetermined DG heading until waypoint passage has occurred or until the next waypoint is selected.

16. Left Hand RADIAL and DISTANCE Thumbwheels -- SET to next waypoint RADIAL and DISTANCE.

NOTE

As first waypoint is reached, it can be replaced with the next waypoint RADIAL and DISTANCE. Then a new waypoint, if necessary, can be set into the right-hand thumbwheels after the initial right-hand waypoint is passed. This procedure can be followed for as many waypoints as necessary, providing that the desired Nav receiver is selected and the VORTAC frequency has been re-channelled to each VORTAC station.

**SECTION 5
PERFORMANCE**

There is no change to the airplane performance when this avionic equipment is installed.

SUPPLEMENT

AREA NAVIGATION SYSTEM

(TYPE ANS-351C)

SECTION 1

GENERAL

The Area Navigation System (Type ANS-351C) consists of an ANS-351C Area Navigation Computer, a compatible Cessna 300 or 400 Series VHF navigation receiver with a course deviation indicator, and a DME-451 System with an IND-450C Indicator.

There are two types of Course Deviation Indicators which may be used with this Area Navigation System. Either a type IN-442AR Indicator with VOR/LOC capabilities, or a type IN-443AR Indicator with VOR/LOC/ILS capabilities may be coupled with the No. 2 navigation receiver. These 400 Series Indicators are not equipped with a course datum synchro to provide course datum information to the autopilot.

NOTE

This is the only installation in which a 400 Series Radio and 400 Series Indicator, coupled with a slaved gyro system, are installed without Course Datum.

The ANS-351C Area Navigation Computer contains concentric rotary switches for waypoint definition entry, an eight-waypoint number selector, an enroute/approach sensitivity control, use and return pushbuttons for waypoint management, a check pushbutton, electronic displays for data readout, and an ambient light sensor to control brightness of digital displays and annunciators. Primary power is applied to the ANS-351C by the Number 2 VHF Navigation Receiver to which it is coupled.

The ANS-351C Area Navigation Computer calculates the following parameters when activated: Crosstrack deviation of the aircraft from the selected course and to/from information displayed on the associated CDI, and (as selected on the DME) ground speed displayed in knots, time-to-waypoint displayed in minutes, or distance-to-waypoint displayed in nautical miles.

The ANS-351C Area Navigation Computer has a built-in flag circuit which causes the waypoint display number to blink anytime a non-active waypoint is displayed. Another built-in flag circuit is built into the RNAV Computer to alert the pilot that the system is not operating in the RNAV mode and that the RNAV has electrically been eliminated from the system, making the computer transparent to all incoming data. When the DME has been switched to NAV 1, HOLD or NAV 2, the RADIAL readout will be flagged with either the word "Vor" or "Loc" to alert the pilot that RNAV mode is inactive. An additional flag circuit is provided in the CDI which causes a red OFF flag to appear anytime a non-usable VOR/DME signal is being received.

CAUTION

If RNAV set is removed from the airplane or becomes inoperative, the associated VHF navigation indicator will be inoperative.

The DME-451 system used in conjunction with this RNAV system consists of a panel-mounted IND-450C Indicator, a remotely-mounted TCR-451 Transceiver and an externally-mounted antenna.

Except for selection of the operating channel, which is selected by the VHF navigation receiver frequency selector switches, the DME-451 system is capable of independent operation. However, only the RNAV mode is to be used with this RNAV system. The DME-451 transmits interrogating pulse pairs on 200 channels between 1041 MHz and 1150 MHz; it receives associated ground-to-air replies between 978 MHz and 1213 MHz. The IND-450C digitally displays distances to or from the selected station up to 200 nautical miles, aircraft ground speed from 30 to 399 knots, or time-to-station with a maximum time of 120 minutes. A Nav mode selector switch provides selection of ON/OFF, Nav 1, Nav 2, Hold and RNAV operation. A DME display selector switch provides selection of distance to or from station (NM), aircraft ground speed (KTS) or time-to-station (MIN). An ambient light sensor automatically controls display intensity.

All operating controls and displays which are part of the ANS-351C Area Navigation Computer, IND-450C Indicator and Course Deviation Indicators IN-442AR and IN-443AR are shown and described in Figure 1. Other controls required for operation of the ANS-351C RNAV system with DME-451 are included on the VHF Nav 2 receiver and are shown and described in the 300 and 400 Nav/Com (Types RT-385A and RT-485A) Supplements in this section.

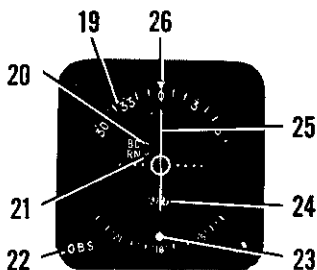
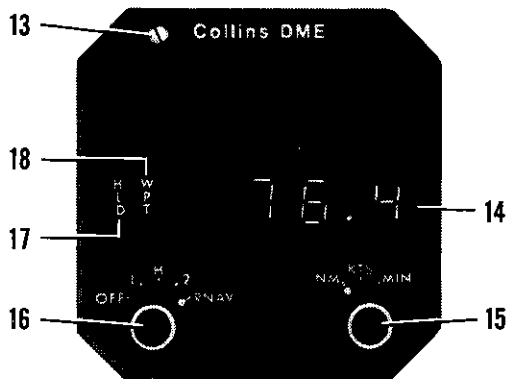
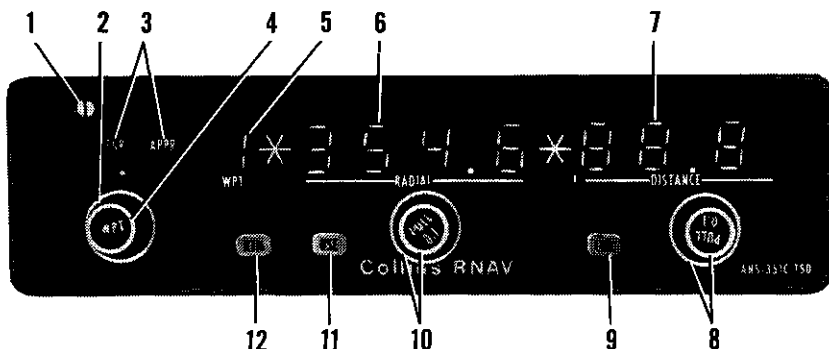

IN-442AR STANDARD VOR/LOC CDI

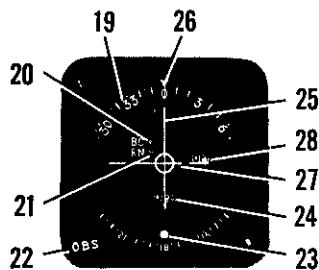

IN-443AR OPTIONAL VOR/LOC/ILS CDI

Figure 1. ANS-351C Computer, IND-450C Indicator and Associated CDI Controls (Sheet 1 of 5)

1. AMBIENT LIGHT SENSOR - Senses ambient cockpit light and controls brightness of digital displays (5, 6, 7) and ENR/APPR annunciators (3).
2. MODE CONTROL KNOB - Selects ENR (enroute) or APPR (approach) modes of operation. In the enroute mode, CDI deviation is 1 nmi/dot, 5 nmi full scale. In approach, deviation is 0.25 nmi/dot, 1 1/4 nmi full scale deflection out to 40 nmi from the waypoint.
3. ENROUTE AND APPROACH MODE ANNUNCIATOR LIGHTS (ENR/APPR) - When the annunciator light illuminates amber under either ENR or APPR modes, it indicates selection of ENR (enroute) sensitivity (1 nmi/dot) or APPR (approach) sensitivity (0.25 nmi/dot).
4. WAYPOINT SELECTOR KNOB (WPT) - Selects the desired display waypoints, from 1 through 8.
5. WAYPOINT NUMBER DISPLAY (WPT 1 thru 8) - Digitally displays (from 1 thru 8) the selected waypoint defined by the displayed data. A blinking number indicates a non-active waypoint; continuously ON number indicates the active waypoint.
6. RADIAL DISPLAY READOUT (RADIAL) - When DME is set to RNAV mode, the computer will digitally display the VOR RADIAL from the reference station on which the waypoint is located. When the DME is set to Nav 1, Hold, or Nav 2, the computer display will spell out "Vor" when a VOR frequency is selected on the Nav receiver, or "Loc" will be spelled out if a localizer frequency is selected on the Nav receiver.

NOTE

Four zeros will be displayed until desired radial data is dialed in.

7. DISTANCE DISPLAY READOUT (DISTANCE) - Digitally displays DISTANCE in nautical miles from the reference station to the waypoint.

NOTE

Three zeros will be displayed until desired distance data is dialed in.

8. DISTANCE SELECTOR KNOBS - Sets distance information in nautical miles into the display. Two concentric knobs control information as follows:

Large outer knob: Changes display in 10 nmi increments.

Small inner knob : Pushed in, changes display in 1 nmi increments.

Pulled out, changes display in 0.1 nmi increments when less than 100 nmi.

Beyond 100 nmi, changes display in 1 nmi increments.

Figure 1. ANS-351C Computer, IND-450C Indicator
and Associated CDI Controls (Sheet 2 of 5)

9. CHECK BUTTON (CHK) - When the CHK pushbutton is pressed and held, and the DME display selector switch is in the NM position, the DME indicator will display distance from the selected DME facility rather than the waypoint. As a signal that raw data is being displayed on the DME, the waypoint annunciator on the DME will be extinguished. Exercising the check feature does not disturb the RNAV calculation, RNAV course deviation display on the CDI, to/from flag or RNAV autopilot coupling. The CHK pushbutton is spring-loaded to ensure return to the RNAV position when released. Brightness of this button is controlled by the radio light dimming rheostat.
10. RADIAL SELECTOR KNOBS - Sets information into the display. Two concentric knobs control information as follows:
 - Large outer knob: Changes display in 10° increments.
 - Small inner knob: Pushed in, changes display in 1° increments.
 - Pulled out, changes display in 0.1° increments.
11. USE PUSHBUTTON - Pressing the USE pushbutton converts the displayed preview waypoint (indicated by a blinking WPT number) into the active waypoint. Brightness of this button is controlled by the radio light dimming rheostat.
12. RETURN PUSHBUTTON (RTN) - Pressing the RTN pushbutton returns the display to the previously selected active waypoint when a non-active waypoint is currently being displayed. Brightness of this button is controlled by the radio light dimming rheostat.
13. AMBIENT LIGHT SENSOR - Senses ambient cockpit light and controls brightness of digital display and WPT and HLD annunciators.
14. DIGITAL DISPLAY - Displays distance to or from station or waypoint (NM), aircraft ground speed (KTS), or time-to-station or waypoint (MIN), depending on the position of the display selector (15).

NOTE

Dashes will be observed on the display until station lock-on occurs in the NM mode or until a velocity of at least 30 knots is established with lock-on in the KTS or MIN mode.

NOTE

In all DME modes including RNAV, aircraft ground speed and time-to-station are meaningful only when the aircraft track is directly to or from the ground station or waypoint. The KTS and MIN indications require approximately 10-12 minutes in RNAV ENR mode or 4-5 minutes in the RNAV APPR mode to attain 90-95 percent final (stabilized) calculated value.

Figure 1. ANS-351C Computer, IND-450C Indicator
and Associated CDI Controls (Sheet 3 of 5)

15. DME DISPLAY SELECTOR SWITCH - Selects desired mode readouts as follows:
NM Position: Displays distance to or from the selected station or waypoint in nautical miles up to 199.9 nmi.
KTS Position: Displays aircraft ground speed up to 399 knots.
MIN Position: Displays time-to-station or waypoint with a maximum time of 120 minutes.

Brightness of this switch is controlled by the radio light dimming rheostat.

16. NAV MODE SELECTOR SWITCH - Applies power to the DME and selects DME operating modes as follows:
OFF: Turns the DME OFF.
NAV 1: Selects DME operation with No. 1 VHF navigation set; enables channel selection by Nav 1 frequency selector switches.
HOLD: Selects DME memory circuit; DME remains channeled to station to which it was last channeled when HOLD was selected and will continue to display information relative to this channel. Allows both the Nav 1 and Nav 2 navigation receivers to be set to new operational frequencies without affecting the previously selected DME operation.

CAUTION

In the Hold mode there is no annunciation of the VOR/DME station frequency. However, an annunciator labeled "HLD" will illuminate on the DME to flag the pilot that the DME is in the Hold mode.

NAV 2: Selects DME operation with No. 2 VHF navigation set; enables channel selection by Nav 2 frequency selector switches.

RNAV: Selects area navigation operation with the No. 2 VHF navigation set.

Brightness of this switch is controlled by the radio light dimming rheostat.

17. HOLD ANNUNCIATOR (HLD) - Illuminates amber to indicate HOLD mode is selected.
18. WAYPOINT ANNUNCIATOR (WPT) - Illuminates amber to indicate RNAV mode is selected.
19. COURSE CARD - Indicates selected VOR or RNAV course under course index.
20. BACK-COURSE LAMP (BC) - Amber light illuminates when an autopilot's back-course function is engaged and receiver is tuned to a localizer frequency; indicates course deviation pointer is reversed. Light dimming is only available when installed with an audio control panel incorporating the annunciator lights DAY/NITE selector switch.
21. AREA NAV LAMP (RN) - When green light is illuminated, indicates that RNAV operation is selected. Light dimming is only available when installed with an audio control panel incorporating the annunciator lights DAY/NITE selector switch.

Figure 1. ANS-351C Computer, IND-450C Indicator
and Associated CDI Controls (Sheet 4 of 5)

22. OMNI BEARING SELECTOR (OBS) - Rotates course card (19) to select desired bearing to or from a VOR station or to or from a selected RNAV waypoint.
23. RECIPROCAL COURSE INDEX - Indicates reciprocal of selected VOR or RNAV course.
24. OFF/TO-FROM INDICATOR - Operates only with VOR, localizer or RNAV signal. OFF position (red flag) indicates unusable signal. With usable VOR signal, when OFF position disappears, indicates whether selected course is TO or FROM station or waypoint. With usable localizer signal, white TO flag is in view.
25. COURSE DEVIATION POINTER - Indicates course deviation from selected VOR or RNAV course or localizer centerline.
26. COURSE INDEX - Indicates selected VOR or RNAV course (bearing).
27. GLIDE SLOPE DEVIATION POINTER - Indicates deviation from ILS glide slope.
28. GLIDE SLOPE "OFF" FLAG - When visible, red OFF flag indicates unreliable glide slope signal or improperly operating equipment. Flag disappears when a reliable glide slope signal is being received.

Figure 1. ANS-351C Computer, IND-450C Indicator
and Associated CDI Controls (Sheet 5 of 5)

SECTION 2

LIMITATIONS

The following RNAV IFR approach limitation must be adhered to during airplane operation.

1. IFR Approaches -- Follow approved published RNAV instrument approach procedures.

SECTION 3

EMERGENCY PROCEDURES

There is no change to the airplane emergency procedures when this avionic equipment is installed.

SECTION 4

NORMAL OPERATION

300 & 400 NAV/COM VOR NAVIGATION CIRCUITS VERIFICATION TEST:

1. Since the TEST position on the 300 and 400 Nav/Com radios is inoperative when the Nav/Coms are coupled to this Area Navigation System, the "VOR SELF TEST OPERATION" as outlined in the 300 and 400 Nav/Com (Types RT-385A and RT-485A) Supplements cannot be used. To check out the complete system, follow the "GROUND CHECK PROCEDURES" as outlined later in this Supplement.

VOR/LOC NAVIGATION:

As a convenience to the pilot, a separate supplement (Avionic Operation Guide) is supplied to explain the various procedures for using the VHF Navigation Set for VOR and localizer navigation. Refer to the Avionic Operation Guide for flight procedures.

AREA NAVIGATION OPERATION NOTES

1. Proper RNAV operation requires valid VOR and DME inputs to the RNAV system. In certain areas, the ground station antenna patterns and transmitter power may be inadequate to provide valid signals to the RNAV. For this reason, intermittent RNAV signal loss may be experienced enroute. Prolonged loss of RNAV signal shall require the pilot to revert to other navigational procedures.
2. As the flight progresses, sequence through waypoints in order, always keep within range of VORTAC being used by maintaining proper altitude and distance from the facility. If usable range is exceeded, the OFF flag will appear on the CDI. Normally, switching waypoints should be done long before flag appearances to ensure the accurate distance, ground speed, time-to-waypoint and minimum crosstrack deviation that will result if closest and strongest signal is used.
3. Selection of the Nav 1, Hold, or Nav 2 positions on the DME Nav mode selector switch electrically eliminates the ANS-351C from the RNAV system, making the computer non-receptive to all incoming data. When operating in these conventional VOR/DME modes, the ANS-351C RADIAL display will spell out "Vor" or "Loc" to prevent being misled into believing that an RNAV waypoint is being flown. Rotating the waypoint selector knob allows preview and set up of waypoints even though operating in the conventional DME modes. Attempting to activate a waypoint in the conventional DME modes by pressing the USE pushbutton will yield no results and the WPT number display will remain blinking, indicating a preview waypoint. Pressing the RTN button will restore the "Vor" or "Loc" annunciation on the RADIAL display and the previously preset waypoints will remain in memory.

NOTE

The ILS mode selection takes precedence over all other mode selection and is automatic whenever an ILS frequency is selected on the No. 2 navigation receiver.

4. If at anytime an ILS frequency is selected on the No. 2 set, with the ANS-351C operating in the RNAV mode, operation will be restored on the same waypoint when a VOR frequency is again selected. This feature allows channeling through ILS frequencies without changing the selected waypoint number.

5. Ground speed, time-to-waypoint, and distance-to-waypoint functions require stabilization time after initial function selection has been made. Allowing 10 minutes for stabilization when operating in the ENR mode will provide a display that is 90 percent of the final calculated value; 12 minutes after initial selection, a display that is 95 percent of the final calculated value will be provided. Stabilization time can be greatly reduced if the APPR mode is selected just prior to, or immediately after, the time that any one of the subject functions is selected. The APPR mode switches in a speed-up circuit that reduces the time for 90 percent of final value display to 4 minutes, and the time for 95 percent of final value display to 5 minutes. After stabilization is achieved, the ENR/APPR control may be switched back to ENR for normal enroute operation.
6. Course changes in excess of 45 degrees will result in temporary display changes for ground speed, time-to-waypoint, or distance-to-waypoint. Initially, ground speed will decrease and both time-to-waypoint and distance-to-waypoint will increase after the course change is made. After the new course has been established for several minutes, all functions will again stabilize and display final calculated values. Course changes exceeding 120 degrees require stabilization time greater than 12 minutes in ENR mode or 5 minutes in APPR mode.
7. For accurate CDI sensitivity, approach mode is restricted to 50 nautical miles or less from the waypoint in use. Enroute mode is restricted to distances no greater than 200 nautical miles from the waypoint in use.
8. VOR/DME facilities must be co-located.
9. The display of time-to-station/waypoint on the DME display, when in RNAV mode, is only valid if aircraft track is "TO" the waypoint.

GROUND CHECK PROCEDURES:

Before each flight in which RNAV is to be used for primary guidance, the following procedures should be used, when possible, to verify RNAV system performance.

1. Taxi the aircraft to position free and clear of metal structures and within good reception distance of a local VOR/DME facility.

2. **SPEAKER/PHONE Selector Switches** (on audio control panel) -- SET NAV 2 to desired mode.
3. **COM OFF/VOL Control** --TURN ON; adjust NAV VOL control to desired audio level.
4. **NAV Frequency Selection** (on No. 2 Nav Receiver) -- SELECT the local VOR/DME frequency.
5. **DME NAV Mode Selector Switch** -- SELECT RNAV mode.
6. **DME DISPLAY Selector Switch** -- SET to NM.
7. **RNAV Mode Control Knob** -- SELECT APPR (approach) mode.
8. **RADIAL and DISTANCE Selector Knobs** -- SELECT all zeros.
9. **NAV 2 Indicator OBS Knob** -- ROTATE to center the course deviation pointer.
10. **DME DIGITAL DISPLAY** -- NOTE DME distance display readout (after the CDI and Distance displays have stabilized).
11. **RNAV CHK Button** -- PRESS to display raw VOR/DME data. The DME distance-to-VOR readout should agree with the previous (step 10) RNAV DME distance-to-waypoint readout within 0.5 NM.
12. **DME NAV MODE Selector Switch** -- SELECT NAV 2 and observe that the CDI remains within 2 dots of center and check that the DME distance-to VOR display remains within 0.5 NM of the distance displayed in step 10.

PREVIEWING AND MODIFYING WAYPOINTS:

NOTES

Modifications to the active waypoint should not be made while the RNAV system is coupled to the autopilot.

Any of the waypoints may be previewed at anytime in any mode.

1. **WPT Selector Knob** -- ROTATE until the desired waypoint number is displayed.
2. **WPT Number Display** -- OBSERVE that number is blinking, indicating that the waypoint is a preview waypoint and not the active waypoint.
3. **RADIAL and DISTANCE Selector Knobs** -- SET as desired if preview waypoint is to be modified.

NOTE

Only the displayed waypoint, whether it is the active waypoint or a preview waypoint, will be affected by the data (Radial and Distance) selector switches.

4. RTN Pushbutton -- PRESS to return the display to the active waypoint number or operating mode (VOR or LOC).

NOTE

In the RNAV mode of operation, the waypoint selector may also be manually rotated until the active waypoint number is again displayed in lieu of using the RTN pushbutton.

5. WAYPOINT Number -- OBSERVE that number is continuously on, indicating that active waypoint is now displayed.

NOTE

Previewing waypoints, whether in the conventional VOR/DME modes or RNAV mode, will not affect system operation in any way.

WAYPOINT PROGRAMMING ON THE GROUND:

1. Using a VFR sectional, enroute instrument chart, instrument approach plate, or enroute RNAV chart -- DETERMINE distance and radial for desired waypoints from appropriate VOR/DME stations.

NOTE

Start engine prior to turning ON avionics equipment.

2. VHF NAV 2 Receiver -- ON to apply power to Nav receiver and RNAV set.
3. DME Nav Mode Selector Switch -- RNAV.
4. WPT Selector Knob -- 1.

NOTE

When power is first applied to the RNAV set, waypoint number 1 will be displayed above the WPT legend as the active waypoint with zero RADIAL and DISTANCE displayed.

5. RADIAL and DISTANCE Selector Knobs -- ROTATE until the desired data is displayed. The displayed data will be automatically transferred into the number 1 waypoint memory.

6. REPEAT Steps 4 and 5 to program remaining waypoints.

NOTE

The displayed waypoint data in the RADIAL and DISTANCE displays before modification is never retained after new waypoint data has been entered. If the active waypoint is revised, the new data will immediately be used in the RNAV computation. Similarly, previewed waypoints, once modified, retain the new data until the waypoint definition is again modified, or the system is turned off.

7. RTN (Return) Pushbutton -- PRESS to display active waypoint.

CHANGING WAYPOINTS IN FLIGHT:

1. WPT Selector Knob -- ROTATE until the desired waypoint number and coordinates are displayed.
2. VHF Nav 2 Receiver -- SELECT the desired reference frequency and identify station by listening to ident tone.
3. Nav Indicator OBS Knob -- SET to desired course.
4. USE Pushbutton -- PRESS and observe that the waypoint identification number stops blinking.
5. DME Display Selector Switch -- SELECT desired display readout. (Distance-to-waypoint will be displayed when NM position is selected.)

NOTE

In the KTS and MIN modes, allow 10-12 minutes to attain a 90-95 percent final (stabilized) calculated value in the ENR mode or 4-5 minutes to attain a 90-95 percent final (stabilized) calculated value in the APPR mode. The NM display is accurate immediately after "lock on".

CHECK FUNCTION:

The distance of the aircraft from the selected VOR/DME station may be checked at anytime while operating in the RNAV mode whenever the DME display selector switch is in the NM position.

1. CHK Pushbutton -- PRESS and HOLD.
2. DME Digital Display -- OBSERVE distance from VOR/DME station displayed.
3. DME WAYPOINT (WPT) Annunciator -- OBSERVE WPT annunciator EXTINGUISHED as a signal that raw DME data is being displayed on the DME.
4. CHK Pushbutton -- RELEASE.

SECTION 5

PERFORMANCE

There is no change to the airplane performance when this avionic equipment is installed. However, the installation of an externally mounted antenna or several related external antennas, will result in a minor reduction in cruise performance.

SUPPLEMENT

**OPTIONAL
SLAVED
HORIZONTAL SITUATION
INDICATOR (HSI)
(TYPE IG-832A)**

**(STANDARD EQUIPMENT
ON 400B IFC SYSTEM)**

**SECTION 1
GENERAL**

The IG-832A Horizontal Situation Indicator (HSI) is an additional navigation indicator option available with Cessna 300 or 400 Nav/Com radios. When dual Nav/Coms are installed, the HSI is coupled to the first Nav/Com and a standard 300 or 400 series VOR/LOC indicator is coupled to the second Nav/Com.

This system consists of a remote Horizontal Situation Indicator (HSI), a SA-832A remote slaving accessory without course datum or an alternate SA-832B with course datum and a remote VOR/LOC converter which is only installed without a RNAV installation. The HSI features the modified ARINC face presentation, providing a slaved gyro heading display with a built-in slaving indicator and full ILS navigation capability. When the HSI is installed with a 400B series Autopilot, a BC light is installed on the instrument panel, adjacent to the HSI, to alert the pilot of back-course operations. Each control and indicator function is described in Figure 1.

**SECTION 2
LIMITATIONS**

There is no change to the airplane limitations when this instrument is installed.

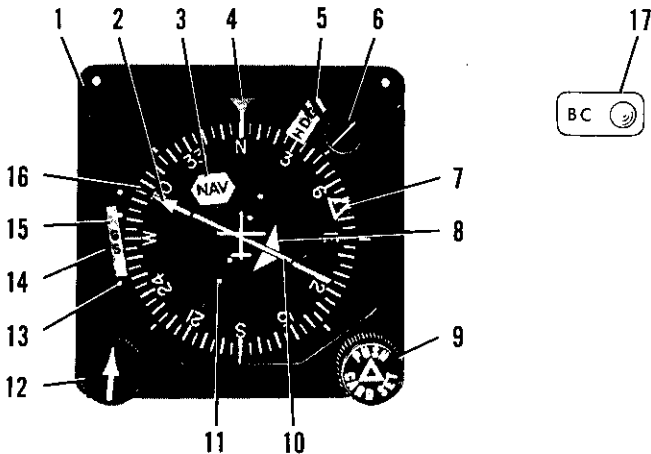

1. HORIZONTAL SITUATION INDICATOR (HSI) - Provides a pictorial presentation of aircraft deviation relative to VOR radials and localizer beams. It also displays glide slope deviations and gives heading reference with respect to magnetic north.
2. OMNI BEARING POINTER - Indicates selected VOR course or localizer course on compass card (16). The selected VOR radial or localizer heading remains set on the compass card when the compass card (16) is rotated.
3. NAV FLAG - When flag is in view, indicates that the NAV receiver signal being received is not reliable.
4. HEADING REFERENCE (LUBBER LINE) - Indicates aircraft magnetic heading on compass card (16).
5. HEADING WARNING FLAG (HDG) - When flag is in view the heading display is invalid due to interruption of either electrical or vacuum power.
6. GYRO SLAVING INDICATOR - Displays visual indication of heading indicator and flux detector synchronization. When slaving needle is aligned with the HSI 45° right index, it shows that the heading indicator agrees with the aircraft magnetic heading. Off-center pointer deflections show the direction of heading indicator error relative to aircraft magnetic heading. The compass CARD SET knob (9) may be used at any time to more rapidly accomplish synchronization of the heading indicator reading with magnetic heading as indicated by the slaving indicator.

Figure 1. Horizontal Situation Indicator (HSI) (Type IG-832A)
(Sheet 1 of 2)

7. HEADING BUG - Indicates selected reference heading relative to the compass card (16).
8. TO/FROM INDICATOR FLAG -- Indicates direction of VOR station relative to selected course.
9. HEADING SELECTOR AND CARD SET KNOB (PUSH Δ CARD SET) - Positions heading "bug" on compass card (16) by rotating the PUSH Δ CARD SET knob. Pushing in and rotating the PUSH Δ CARD SET knob, sets the compass card. The "bug" (7) rotates with the compass card.
10. COURSE (OMNI) DEVIATION BAR - Bar is center portion of omni bearing pointer and moves laterally to pictorially indicate relationship of aircraft to selected course. It relates in degrees of angular displacement from VOR radials or localizer beam center.
11. COURSE DEVIATION DOTS - A course deviation bar displacement of 2 dots represents full scale (VOR = $\pm 10^\circ$ or LOC = $\pm 2\frac{1}{2}^\circ$) deviation from beam centerline.
12. COURSE SELECTOR (\uparrow) KNOB - When rotated, positions omni bearing selector (2) on the compass card (16) to select desired VOR radial or localizer course.
13. GLIDE SLOPE SCALE - Indicates displacement from glide slope beam center. A glide slope deviation bar displacement of 2 dots, represents full scale (0.7°) deviation above or below glide slope beam centerline.
14. GLIDE SLOPE POINTER - Indicates on glide slope scale (13) aircraft displacement from glide slope beam center.
15. GLIDE SLOPE FLAG - When in view, indicates glide slope receiver signal is not reliable.
16. COMPASS CARD - Rotates to display heading of airplane with reference to lubber line (4).
17. BC LIGHT (Installed in a remote position, as shown, with a 400B Autopilot only. The BC light is incorporated in the mode selector on the 400B IFC system.) - Remote amber BC light installed with a 400B Autopilot will illuminate when back-course operation is selected by the REV SNS (Reverse Sense) LOC 1 switch located in the autopilot accessory unit. With 400B IFC system, when back-course operation is selected, the BC light incorporated in the MODE SELECTOR will illuminate green.

CAUTION

When back-course operation is selected, the omni deviation bar on the HSI does not reverse. However, selection of back-course operation will always cause the localizer signal to the autopilot to reverse for back-course operation.

Figure 1. Horizontal Situation Indicator (HSI) (Type IG-832A)
(Sheet 2 of 2)

SECTION 3

EMERGENCY PROCEDURES

There is no change to the airplane emergency procedures when this instrument is installed.

SECTION 4

NORMAL PROCEDURES

Normal procedures for operation of this system differ little from those required for the more conventional Course Deviation Indicators. However, several small differences are worth noting.

The rectilinear movement of the omni deviation bar in combination with the rotation of the compass card in response to heading changes, provides an intuitive picture of the navigation situation at a glance when tuned to an omni station. When tuned to a localizer frequency, the omni bearing pointer must be set to the inbound front course for both front and back-course approaches to retain this pictorial presentation.

When the HSI system is installed with a Cessna 400B (Type IF-550A) Autopilot, a back-course indicator light labeled BC, is mounted adjacent to the HSI and will illuminate amber when the reverse sense (REV SNS) switch (mounted in the autopilot accessory unit) is placed in the ON (LOC 1) position to alert the pilot that back-course operation is selected. The BC light is incorporated in the MODE SELECTOR on the 400B IFCS system. The HSI needle will not be reversed but the LOC signals to the autopilot will be. Light dimming for both types of BC lighting is provided for low ambient light conditions.

For normal procedures with autopilots, refer to the 400B and 400B IFCS Autopilot Supplements in this handbook if they are listed in this section as options. A description of course datum and autopilot procedures for course datum are incorporated in the appropriate autopilot supplements.

NOTE

Both electrical and vacuum power must be supplied to this instrument for proper functioning. Absence of either will result in unreliable heading information.

SECTION 5

PERFORMANCE

There is no change to the airplane performance when this instrument is installed.

SUPPLEMENT

SSB HF TRANSCEIVER

(TYPE ASB-125)

SECTION 1

GENERAL

The ASB-125 HF transceiver is an airborne, 10-channel, single side-band (SSB) radio with a compatible amplitude modulated (AM) transmitting-receiving system for long range voice communications in the 2 to 18 MHz frequency range. The system consists of a panel mounted receiver/exciter, a remote mounted power amplifier/power supply, an antenna coupler and an externally mounted, fixed wire, medium/high frequency antenna.

A channel selector knob determines the operating frequency of the transceiver which has predetermined crystals installed to provide the desired operating frequencies. A mode selector control is provided to supply the type of emission required for the channel, either sideband, AM or telephone for public correspondence. An audio knob, clarifier knob and squelch knob are provided to assist in audio operation during receive. In addition to the aforementioned controls, which are all located on the receiver/exciter, a meter is incorporated to provide antenna loading readouts.

The system utilizes the airplane microphone, headphone and speaker. Operation and description of the audio control panels used in conjunction with this radio are shown and described in another supplement in this section.

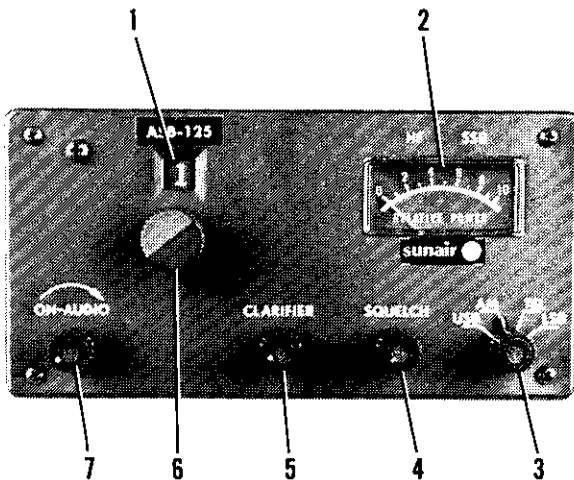

1. CHANNEL WINDOW - Displays selected channel.
2. RELATIVE POWER METER - Indicates relative radiated power of the power amplifier/antenna system.
3. MODE SELECTOR CONTROL - Selects one of the desired operating modes:
 - USB - Selects upper sideband operation for long range voice communications.
 - AM - Selects compatible AM operation and full AM reception.
 - TEL - Selects upper sideband with reduced carrier, used for public correspondence telephone and ship-to-shore.
 - LSB - (Optional) Selects lower sideband operation (not legal in U.S., Canada and most other countries).
4. SQUELCH CONTROL - Used to adjust signal threshold necessary to activate receiver audio. Clockwise rotation increases background noise (decreases squelch action); counterclockwise rotation decreases background noise.
5. CLARIFIER CONTROL - Used to "clarify" single sideband speech during receive while in USB mode only.
6. CHANNEL SELECTOR CONTROL - Selects desired channel. Also selects AM mode if channel frequency is 2003 kHz, 2182 kHz or 2638 kHz.
7. ON - AUDIO CONTROL - Turns set ON and controls receiver audio gain.

Figure 1. SSB HF Transceiver Operating Controls

SECTION 2 LIMITATIONS

There is no change to the airplane limitations when this avionic equipment is installed.

SECTION 3 EMERGENCY PROCEDURES

There is no change to the airplane emergency procedures when this avionic equipment is installed.

SECTION 4 NORMAL PROCEDURES

COMMUNICATIONS TRANSCEIVER OPERATION:

NOTE

The pilot should be aware of the two following radio operational restrictions:

- a. For sideband operation in the United States, Canada and various other countries, only the upper sideband may be used. Use of lower sideband is prohibited.
 - b. Only AM transmissions are permitted on frequencies 2003 kHz, 2182 kHz and 2638 kHz. The selection of these channels will automatically select the AM mode of transmission.
1. XMTR SEL Switch (on audio control panel) -- SELECT transceiver.
 2. SPEAKER/PHONE Selector Switches (on audio control panel) -- SELECT desired mode.
 3. ON-AUDIO Control -- ON (allow equipment to warm up for 5 minutes for sideband or one minute for AM operation and adjust audio to comfortable listening level).
 4. Channel Selector Control -- SELECT desired frequency.
 5. Mode Selector Control -- SELECT operating mode.

6. SQUELCH Control -- ADJUST clockwise for normal background noise output, then slowly adjust counterclockwise until the receiver is silent.
7. CLARIFIER Control -- ADJUST when upper single sideband RF signal is being received for maximum clarity.
8. Mike Button:
 - a. To Transmit -- DEPRESS and SPEAK into microphone.

NOTE

Sidetone and interphone intercom is not available on this radio.

- b. To Receive -- RELEASE mike button.

NOTE

Voice communications are not available in the LSB mode.

NOTE

Lower sideband (LSB) mode is not legal in the U.S., Canada, and most other countries.

SECTION 5 PERFORMANCE

There is no change to the airplane performance when this avionic equipment is installed. However, the installation of an externally mounted antenna or several related external antennas, will result in a minor reduction in cruise performance.

SUPPLEMENT

OPTIONAL UNSLAVED HORIZONTAL SITUATION INDICATOR (HSI) (TYPE IG-832C)

SECTION 1 GENERAL

The IG-832C Horizontal Situation Indicator (HSI) is an additional navigation indicator option which provides a heading reference with respect to an unslaved directional gyro, a heading reference bug, VOR course selection, and a pictorial presentation of the airplane position relative to VOR and localizer courses and glide slopes. This indicator is used with Cessna 300 and 400 Nav/Com radios. When dual Nav/Com radios are installed, the HSI is coupled to the number 1 NAV/COM and a standard 300 or 400 series VOR/LOC course deviation indicator is coupled to the number 2 NAV/COM.

This system consists of a Horizontal Situation Indicator (HSI-Type IG-832C) and a remote mounted VOR/LOC Converter (Type B-445A). The indicator is unslaved and course datum is not available. When the HSI is installed with a 300A or 400B Autopilot system, a BC light is installed on the instrument panel, adjacent to the HSI, to alert the pilot of back-course operation. Each control and indicator function is described in Figure 1.

SECTION 2 LIMITATIONS

There is no change to the airplane limitations when this instrument is installed.

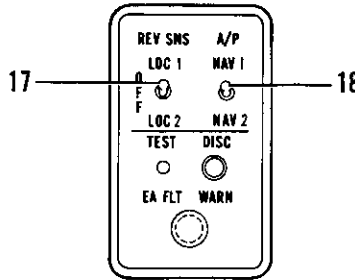
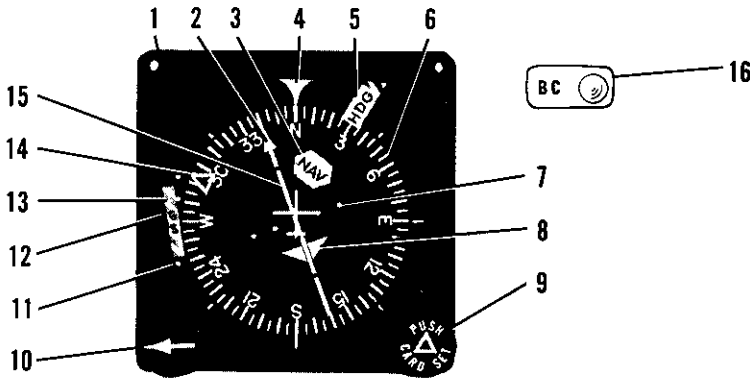

USED WITH 400B AUTOPILOT

1. **HORIZONTAL SITUATION INDICATOR (HSI)** - Provides a pictorial presentation of aircraft deviation relative to VOR radials and localizer beams. It also displays glide slope deviations and gives heading reference with respect to magnetic north when compass card is set to agree with compass.
2. **OMNI BEARING POINTER** - Indicates selected VOR course or localizer course on compass card (6). The selected VOR radial or localizer heading remains set on the compass card when the compass card (6) is rotated.
3. **NAV FLAG** - When flag is in view, indicates that the NAV receiver signal being received is not reliable.

Figure 1. Horizontal Situation Indicator (HSI) (Type IG-832C)
(Sheet 1 of 3)

4. HEADING REFERENCE (LUBBER LINE) - Indicates aircraft magnetic heading on compass card (6).
5. HEADING WARNING FLAG (HDG) - When flag is in view, the heading display is invalid due to interruption of either electrical or vacuum power.
6. COMPASS CARD - Rotates to display heading of airplane with reference to lubber line (4). Must be set to agree with aircraft compass using Card Set Knob (9).
7. COURSE DEVIATION DOTS - Indicates aircraft displacement from VOR, or localizer beam center. A full scale (2 dots) course deviation bar (15) displacement represents the following deviations from beam center:
 - a. VOR = $\pm 10^\circ$ approx.
 - b. LOC = $\pm 2-1/2^\circ$ approx.
8. TO/FROM INDICATOR FLAG - Indicates direction of VOR station relative to selected course.
9. HEADING SELECTOR AND CARD SET KNOB (PUSH \blacktriangle CARD SET) - When rotated in normal (out) position, positions heading "bug" (14) on compass card (6) to indicate selected heading for reference or for autopilot tracking. When pushed in and rotated, sets compass card (6) to agree with magnetic compass. The omni bearing pointer (2), heading bug (14), and deviation bar (15) rotate with the compass card (6).

NOTE

The compass card (6) must be reset periodically to compensate for precessional errors in the gyro.

10. COURSE SELECTOR (\downarrow) KNOB - When rotated, positions omni bearing pointer (2) on the compass card (6) to select desired VOR radial or localizer course.
11. GLIDE SLOPE SCALE - Indicates displacement from glide slope beam center. A glide slope deviation bar displacement of 2 dots, represents full scale (0.7°) deviation above or below glide slope beam centerline.
12. GLIDE SLOPE POINTER - Indicates on glide slope scale (11) aircraft displacement from glide slope beam center.
13. GLIDE SLOPE FLAG - When in view, indicates glide slope receiver signal is not reliable.
14. HEADING BUG - Indicates selected reference heading relative to compass card (6).
15. COURSE (OMNI) DEVIATION BAR - Bar is center portion of omni bearing pointer and moves laterally to pictorially indicate relationship of aircraft to selected course. It relates in degrees of angular displacement from VOR radials or localizer beam center (see Item 7).

Figure 1. Horizontal Situation Indicator (HSI) (Type IG-832C)
(Sheet 2 of 3)

16. BACK-COURSE LIGHT (BC) (Installed in a remote position, as shown, with 300A and 400B Autopilots only.) - The remote BC light will illuminate amber when back-course operation is selected either by the REV SNS LOC 1 switch (17) mounted in the 400B autopilot's accessory unit or the BACK CRS pushbutton on the 300A autopilot. Light dimming is only available when installed with an audio control panel incorporating the annunciator lights DAY/NITE selector switch.

CAUTION

When back-course operation is selected, the course (omni) deviation bar (15) on the HSI does not reverse. However, selection of back-course operation will always cause the localizer signal to the autopilot to reverse for back-course operation.

17. BACK COURSE REVERSE SENSE (REV SNS) LOC 1 OR LOC 2 SELECTOR SWITCH (Installed with 400B Autopilot only) - With AP switch ON (on 400B Autopilot control unit) and either LOC 1 or LOC 2 selected, localizer signals to the Cessna 400B Autopilot will reverse for back-course operation. With autopilot ON or OFF, the course (omni) deviation bar on the HSI will not reverse but the standard CDI pointer will reverse depending on the position of the REV SNS switch.

NOTE

With the 300A Autopilot this operation is accomplished by activating the BACK CRS pushbutton.

18. AUTOPILOT (A/P) NAV 1 OR NAV 2 SELECTOR SWITCH - (Installed with 400B Autopilot only) Selects appropriate signals from the desired navigation receiver to be coupled to the autopilot.

SECTION 3 EMERGENCY PROCEDURES

There is no change to the airplane emergency procedures when this instrument is installed.

Figure 1. Horizontal Situation Indicator (HSI) (Type IG-832C)
(Sheet 3 of 3)

SECTION 4

NORMAL PROCEDURES

NOTE

Both electrical and vacuum power must be supplied to this instrument for proper functioning. Absence of either will result in unreliable heading information.

Normal procedures for operation of this system differ little from those required for the more conventional Course Deviation Indicators. However, several small differences are worth noting.

The rectilinear movement of the omni deviation bar in combination with the rotation of the compass card in response to heading changes, provides an intuitive picture of the navigation situation at a glance when turned to an omni station. When tuned to a localizer frequency, the omni bearing pointer must be set to the inboard front course for both front and back-course approaches to retain this pictorial presentation.

When the HSI system is installed with a Cessna 300A (Type AF-395A) or Cessna 400B (Type IF-550A) Autopilot, a back-course indicator light labeled BC, is mounted adjacent to the HSI and will illuminate amber when either the reverse sense (REV SNS) switch (mounted in the 400B autopilot's accessory unit) is placed in the ON (LOC 1) position or the BACK CRS pushbutton on the 300A Autopilot is activated to alert the pilot that back-course operation is selected. With either autopilot the HSI needle will not be reversed but the LOC signals to the autopilot will be. Light dimming for the BC light is only available when installed with an audio control panel incorporating the annunciator lights DAY/NITE selector switch.

For normal procedures with autopilots, refer to the 300A or 400B Autopilot Supplements in this handbook if they are listed in this section as options.

SECTION 5

PERFORMANCE

There is no change to the airplane performance when this instrument is installed.

SUPPLEMENT

CESSNA NAVOMATIC 200A AUTOPILOT (Type AF-295B)

SECTION 1 GENERAL

The Cessna 200A Navomatic is an all electric, single-axis (aileron control) autopilot system that provides added lateral and directional stability. Components are a computer-amplifier, a turn coordinator, an aileron actuator, and a course deviation indicator(s) incorporating a localizer reversed (BC) indicator light

Roll and yaw motions of the airplane are sensed by the turn coordinator gyro. The computer-amplifier electronically computes the necessary correction and signals the actuator to move the ailerons to maintain the airplane in the commanded lateral attitude.

The actuator includes a thermostatic switch which monitors the operating temperature of the motor. If the temperature becomes abnormal, the thermostatic switch opens and disengages the autopilot to remove power from the actuator. After approximately 10 minutes, the switch will automatically close to reapply power to the actuator and autopilot system.

The 200A Navomatic will also capture and track a VOR or localizer course using signals from a VHF navigation receiver.

The operating controls for the Cessna 200A Navomatic are located on the front panel of the computer-amplifier, shown in Figure 1. The primary function pushbuttons (DIR HOLD, NAV CAPT, and NAV TRK), are interlocked so that only one function can be selected at a time. The HISENS and BACK CRS pushbuttons are not interlocked so that either or both of these functions can be selected at any time.

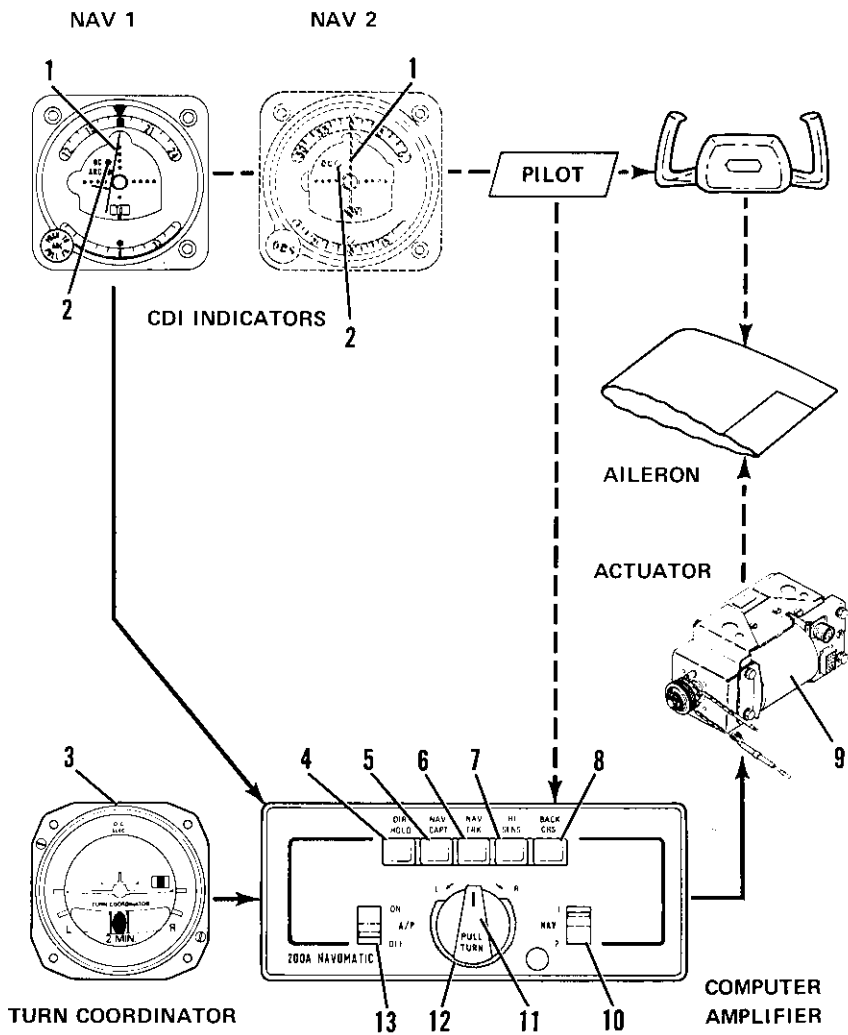

Figure 1. Cessna 200A Autopilot, Operating Controls and Indicators
(Sheet 1 of 2)

1. **COURSE DEVIATION INDICATOR** - Provides VOR/LOC navigation inputs to autopilot for intercept and tracking modes.
2. **LOCALIZER REVERSED INDICATOR LIGHT** - Amber light, labeled BC, illuminates when BACK CRS button is pushed in (engaged) and LOC frequency selected. BC light indicates course indicator needle is reversed on selected receiver (when turned to a localizer frequency). This light is located within the CDI indicator.
3. **TURN COORDINATOR** - Senses roll and yaw for wings leveling and command turn functions.
4. **DIR HOLD PUSHBUTTON** - Selects direction hold mode. Airplane holds direction it is flying at time button is pushed.
5. **NAV CAPT PUSHBUTTON** - Selects NAV capture mode. When parallel to desired course, the airplane will turn to a pre-described intercept angle and capture selected VOR or LOC course.
6. **NAV TRK PUSHBUTTON** - Selects NAV track mode. Airplane tracks selected VOR or LOC course.
7. **HI SENS PUSHBUTTON** - During NAV CAPT or NAV TRK operation, this high sensitivity setting increases autopilot response to NAV signal to provide more precise operation during localizer approach. In low sensitivity position (push-button out), response to NAV signal is dampened for smoother tracking of enroute VOR radials; it also smooths out effect of course scalloping during NAV operation.
8. **BACK CRS PUSHBUTTON** - Used with LOC operation only. With A/P switch OFF or ON, and when navigation receiver selected by NAV switch is set to a localizer frequency, it reverses normal localizer needle indication (CDI) and causes localizer reversed (BC) light to illuminate. With A/P switch ON, reverses localizer signal to autopilot.
9. **ACTUATOR** - The torque motor in the actuator causes the ailerons to move in the commanded direction.
10. **NAV SWITCH** - Selects NAV 1 or NAV 2 navigation receiver.
11. **PULL TURN KNOB** - When pulled out and centered in detent, airplane will fly wings-level; when turned to the right (R), the airplane will execute a right, standard rate turn; when turned to the left (L), the airplane will execute a left, standard rate turn. When centered in detent and pushed in, the operating mode selected by a pushbutton is engaged.
12. **TRIM** - Used to trim autopilot to compensate for minor variations in aircraft trim or weight distribution. (For proper operation, the aircraft's rudder trim, if so equipped, must be manually trimmed before the autopilot is engaged.)
13. **A/P SWITCH** - Turns autopilot ON or OFF.

Figure 1. Cessna 200A Autopilot, Operating Controls and Indicators
(Sheet 2 of 2)

SECTION 2 LIMITATIONS

The following autopilot limitation must be adhered to:

BEFORE TAKE-OFF AND LANDING:

1. A/P ON-OFF Switch -- OFF.

SECTION 3 EMERGENCY PROCEDURES

TO OVERRIDE THE AUTOPILOT:

1. Airplane Control Wheel -- ROTATE as required to override autopilot.

NOTE

The servo may be overpowered at anytime without damage.

TO TURN OFF AUTOPILOT:

1. A/P ON-OFF Switch -- OFF.

SECTION 4 NORMAL PROCEDURES

BEFORE TAKE-OFF AND LANDING:

1. A/P ON-OFF Switch -- OFF.
2. BACK CRS Button -- OFF (see Caution note under Nav Capture).

NOTE

Periodically verify operation of amber warning light(s), labeled BC on CDI(s), by engaging BACK CRS button with a LOC frequency selected, or use TEST function on the audio control panel to verify BC light operation.

INFLIGHT WINGS LEVELING:

1. Airplane Rudder Trim -- ADJUST for zero slip ("Ball" centered on Turn Coordinator).
2. PULL-TURN Knob -- CENTER and PULL out.
3. A/P ON-OFF Switch -- ON.
4. Autopilot TRIM Control -- ADJUST for zero turn rate (wings level indication on Turn Coordinator).

NOTE

For optimum performance in airplanes equipped as float-planes, use autopilot only in cruise flight or in approach configuration with flaps down no more than 10° and airspeed no lower than 75 KIAS on 172 and R172 Series Models, 90 KIAS on 180, 185 Models and 95 KIAS on U206 and TU206 Series Models.

COMMAND TURNS:

1. PULL-TURN Knob -- CENTER, PULL out and ROTATE.

DIRECTION HOLD:

1. PULL-TURN Knob -- CENTER and PULL out.
2. Autopilot TRIM Control -- ADJUST for zero turn rate.
3. Airplane Rudder Trim -- ADJUST for zero slip ("Ball" centered).
4. DIR HOLD Button -- PUSH.
5. PULL-TURN Knob -- PUSH in detent position when airplane is on desired heading.
6. Autopilot TRIM Control -- READJUST for zero turn rate.

NAV CAPTURE (VOR/LOC):

1. PULL-TURN Knob -- CENTER and PULL out.
2. NAV 1-2 Selector Switch -- SELECT desired VOR receiver.
3. Nav Receiver OBS or ARC Knob -- SET desired VOR course (if tracking omni).

NOTE

Optional ARC knob should be in center position and ARC amber warning light should be off.

4. NAV CAPT Button -- PUSH.
5. HI SENS Button -- PUSH for localizer and "close-in" omni intercepts.

6. BACK CRS Button -- PUSH only if intercepting localizer front course outbound or back course inbound.

CAUTION

With BACK CRS button pushed in and localizer frequency selected, the CDI on selected nav radio will be reversed even when the autopilot switch is OFF.

7. PULL-TURN Knob -- Turn airplane parallel to desired course.

NOTE

Airplane must be turned until heading is within $\pm 5^\circ$ of desired course.

8. PULL TURN Knob -- CENTER and PUSH in. The airplane should then turn toward desired course at $45^\circ \pm 10^\circ$ intercept angle (if the CDI needle is in full deflection).

NOTE

If more than 15 miles from the station or more than 3 minutes from intercept, use a manual intercept procedure.

NAV TRACKING (VOR/LOC):

1. NAV TRK Button -- PUSH when CDI centers and airplane is within $\pm 5^\circ$ of course heading.
2. HI SENS BUTTON -- DISENGAGE for enroute omni tracking (leave ENGAGED for localizer).
3. Autopilot TRIM Control -- READJUST as required to maintain track.

NOTE

Optional ARC function, if installed, should not be used for autopilot operation. If airplane should deviate off course, pull out PULL TURN knob and readjust airplane rudder trim for straight flight on the Turn Coordinator. Push in PULL TURN knob to reintercept course. If deviation persists, progressively make slight adjustments of autopilot TRIM control towards the course as required to maintain track.

SECTION 5 PERFORMANCE

There is no change to the airplane performance when this avionic equipment is installed.

SUPPLEMENT

CESSNA 300 ADF

(Type R-546E)

SECTION 1

GENERAL

The Cessna 300 ADF is a panel-mounted, digitally tuned automatic direction finder. It is designed to provide continuous 1 kHz digital tuning in the frequency range of 200 kHz to 1,699 kHz and eliminates the need for mechanical band switching. The system is comprised of a receiver, a bearing indicator, a loop antenna, and a sense antenna. Operating controls and displays for the Cessna 300 ADF are shown and described in Figure 1. The audio systems used in conjunction with this radio for speaker-phone selection are shown and described in another supplement in this section.

The Cessna 300 ADF can be used for position plotting and homing procedures, and for aural reception of amplitude-modulated (AM) signals.

With the function selector knob at ADF, the Cessna 300 ADF provides a visual indication, on the bearing indicator, of the bearing to the transmitting station relative to the nose of the airplane. This is done by combining signals from the sense antenna with signals from the loop antenna.

With the function selector knob at REC, the Cessna 300 ADF uses only the sense antenna and operates as a conventional low-frequency receiver.

The Cessna 300 ADF is designed to receive transmission from the following radio facilities: commercial AM broadcast stations, low-frequency range stations, non-directional radio beacons, ILS compass locators.

SECTION 2

LIMITATIONS

There is no change to the airplane limitations when this avionics equipment is installed.

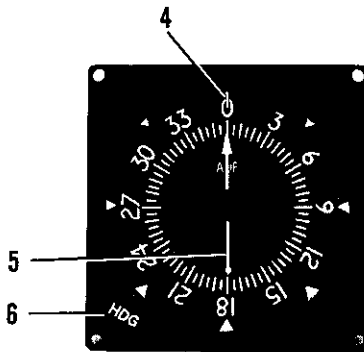
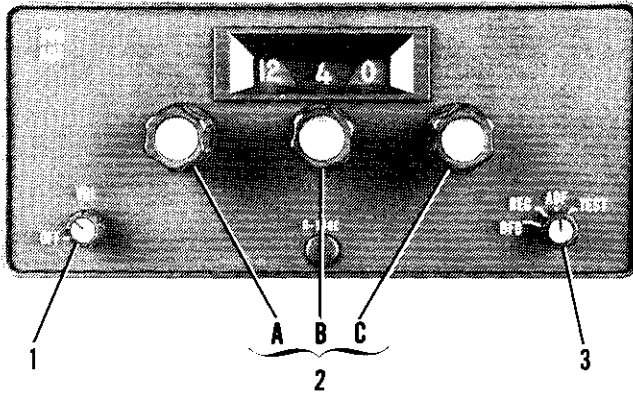

1. OFF/VOL CONTROL - Controls primary power and audio output level. Clockwise rotation from OFF position applies primary power to receiver; further clockwise rotation increases audio level.
2. FREQUENCY SELECTORS - Knob (A) selects 100-kHz increments of receiver frequency, knob (B) selects 10-kHz increments, and knob (C) selects 1 kHz increments.

Figure 1. Cessna 300 ADF Operating Controls and Indicators (Sheet 1 of 2)

3. FUNCTION SWITCH:

BFO: Selects operation as communication receiver using only sense antenna and activates 1000-Hz tone beat frequency oscillator to permit coded identifier of stations transmitting keyed CW signals (Morse Code) to be heard.

REC: Selects operation as standard communication receiver using only sense antenna.

ADF: Set operates as automatic direction finder using loop and sense antennas.

TEST: Momentary-on position used during ADF operation to test bearing reliability. When held in TEST position, slews indicator pointer clockwise; when released, if bearing is reliable, pointer returns to original bearing position.

4. INDEX (ROTATABLE CARD) - Indicates relative, magnetic, or true heading of aircraft, as selected by HDG control.
5. POINTER - Indicates station bearing in degrees of azimuth, relative to the nose of the aircraft. When heading control is adjusted, indicates relative, magnetic, or true bearing of radio signal.
6. HEADING CARD CONTROL (HDG) - Rotates card to set in relative, magnetic, or true bearing information.

Figure 1. Cessna 300 ADF Operating Controls and Indicators (Sheet 2 of 2)

SECTION 3

EMERGENCY PROCEDURES

There is no change to the airplane emergency procedures when this avionic equipment is installed.

SECTION 4

NORMAL PROCEDURES

TO OPERATE AS A COMMUNICATIONS RECEIVER ONLY:

1. OFF/VOL Control -- ON.
2. Function Selector Knob -- REC.
3. Frequency Selector Knobs -- SELECT operating frequency.
4. ADF SPEAKER/PHONE Selector Switch (on audio control panel) -- SELECT speaker or phone position as desired.
5. VOL Control -- ADJUST to desired listening level.

TO OPERATE AS AN AUTOMATIC DIRECTION FINDER:

1. OFF/VOL Control -- ON.
2. Frequency Selector Knobs -- SELECT operating frequency.
3. ADF SPEAKER/PHONE Selector Switch (on audio control panel) -- SELECT AS DESIRED.
4. Function Selector Knob -- ADF position and note relative bearing on indicator.

TO TEST RELIABILITY OF AUTOMATIC DIRECTION FINDER:

1. Function Selector Knob -- ADF position and note relative bearing on indicator.
2. Function Selector Knob -- TEST position and observe that pointer moves away from relative bearing at least 10 to 20 degrees.
3. Function Selector Knob -- ADF position and observe that pointer returns to same relative bearing as in step (1).

TO OPERATE BFO:

1. OFF/VOL Control -- ON.
2. Function Selector Knob -- BFO.
3. Frequency Selector Knobs -- SELECT operating frequency.
4. ADF SPEAKER/PHONE Selector Switch (on audio control panel) -- SELECT speaker or phone position as desired.

5. VOL Control -- ADJUST to desired listening level.

NOTE

A 1000-Hz tone is heard in the audio output when a CW signal (Morse Code) is tuned in properly.

SECTION 5 PERFORMANCE

There is no change to the airplane performance when this avionic equipment is installed. However, the installation of an externally mounted antenna or related external antennas, will result in a minor reduction in cruise performance.

SUPPLEMENT

CESSNA 300 NAV/COM (720-Channel - Type RT-385A)

SECTION 1 GENERAL

The Cessna 300 Nav/Com (Type RT-385A), shown in figure 1, consists of a panel-mounted receiver-transmitter and a single or dual-pointer remote course deviation indicator.

The set includes a 720-channel VHF communications receiver-transmitter and a 200-channel VHF navigation receiver, both of which may be operated simultaneously. The communications receiver-transmitter receives and transmits signals between 118.000 and 135.975 MHz in 25-kHz steps. The navigation receiver receives omni and localizer signals between 108.00 and 117.95 MHz in 50-kHz steps. The circuits required to interpret the omni and localizer signals are located in the course deviation indicator. Both the communications and navigation operating frequencies are digitally displayed by incandescent readouts on the front panel of the Nav/Com.

A DME receiver-transmitter or a glide slope receiver, or both, may be interconnected with the Nav/Com set for automatic selection of the associated DME or glide slope frequency. When a VOR frequency is selected on the Nav/Com, associated VORTAC or VOR-DME station frequency will also be selected automatically; likewise, if a localizer frequency is selected, the associated glide slope will be selected automatically.

The course deviation indicator includes either a single-pointer and related NAV flag for VOR/LOC indication only, or dual pointers and related NAV and GS flags for both VOR/LOC and glide slope indications. Both types of course deviation indicators incorporate a back-course lamp (BC) which lights when optional back course (reversed sense) operation is selected. Both types may be provided with Automatic Radial Centering which, depending on how it is selected, will automatically indicate the bearing TO or FROM the VOR station.

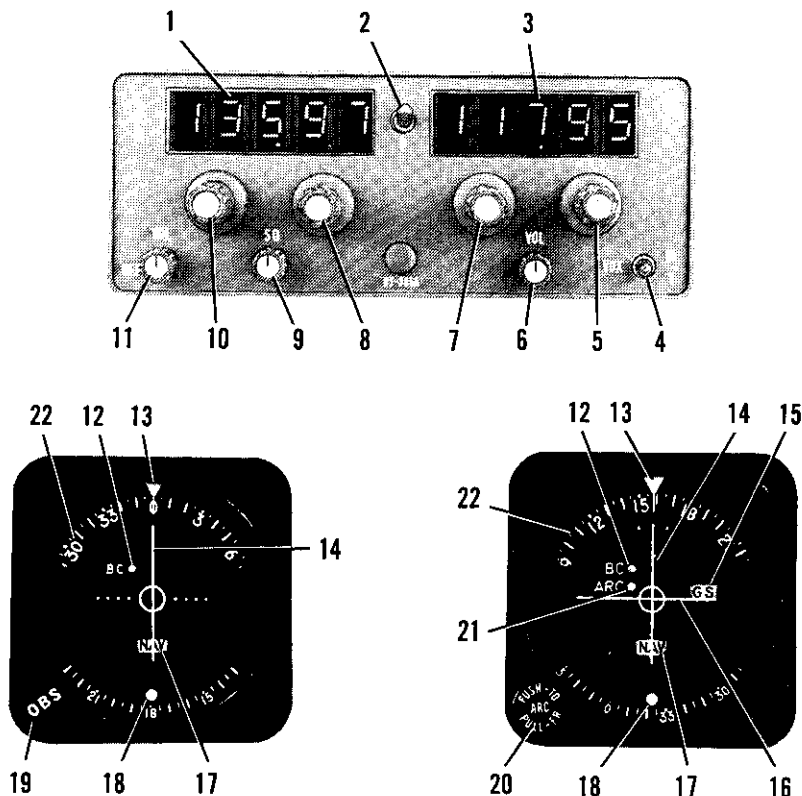

1. COMMUNICATION OPERATING FREQUENCY READOUT (Third-decimal-place is shown by the position of the "5-0" switch).
2. 5-0 SWITCH - Part of Com Receiver-Transmitter Fractional MHz Frequency Selector. In "5" position, enables Com frequency readout to display and Com Fractional MHz Selector to select frequency in .05-MHz steps between .025 and .975 MHz. In "0" position, enables COM frequency readout to display and Com Fractional MHz Selector to select frequency in .05-MHz steps between .000 and .950 MHz.

NOTE

The "5" or "0" may be read as the third decimal digit, which is not displayed in the Com fractional frequency display.

Figure 1. Cessna 300 Nav/Com (Type RT-385A), Operating Controls and Indicators (Sheet 1 of 3)

3. NAVIGATION OPERATING FREQUENCY READOUT.
4. ID-VOX-T SWITCH - With VOR or LOC station selected, in ID position, station identifier signal is audible; in VOX (Voice) position, identifier signal is suppressed; in T (Momentary On) position, the VOR navigational self-test function is selected.
5. NAVIGATION RECEIVER FRACTIONAL MEGAHERTZ SELECTOR - Selects Nav frequency in .05-MHz steps between .00 and .95 MHz; simultaneously selects paired glide slope frequency and DME channel.
6. NAV VOL CONTROL - Adjusts volume of navigation receiver audio.
7. NAVIGATION RECEIVER MEGAHERTZ SELECTOR - Selects NAV frequency in 1-MHz steps between 108 and 117 MHz; simultaneously selects paired glide slope frequency and DME channel.
8. COMMUNICATION RECEIVER-TRANSMITTER FRACTIONAL MEGAHERTZ SELECTOR - Depending on position of 5-0 switch, selects COM frequency in .05-MHz steps between .000 and .975 MHz. The 5-0 switch identifies the last digit as either 5 or 0.
9. SQUELCH CONTROL - Used to adjust signal threshold necessary to activate COM receiver audio. Clockwise rotation increases background noise (decreases squelch action); counterclockwise rotation decreases background noise.
10. COMMUNICATION RECEIVER-TRANSMITTER MEGAHERTZ SELECTOR - Selects COM frequency in 1-MHz steps between 118 and 135 MHz.
11. COM OFF-VOL CONTROL - Combination on/off switch and volume control; turns on NAV/COM set and controls volume of communications receiver audio.
12. BC LAMP - Amber light illuminates when an autopilot's back-course (reverse sense) function is engaged; indicates course deviation pointer is reversed on selected receiver when tuned to a localizer frequency. Light dimming is only available when installed with an audio control panel incorporating the annunciator lights DAY/NITE selector switch.
13. COURSE INDEX - Indicates selected VOR course.
14. COURSE DEVIATION POINTER - Indicates course deviation from selected omni course or localizer centerline.
15. GLIDE SLOPE "GS" FLAG - When visible, red GS flag indicates unreliable glide slope signal or improperly operating equipment. Flag disappears when a reliable glide slope signal is being received.
16. GLIDE SLOPE DEVIATION POINTER - Indicates deviation from ILS glide slope.

Figure 1. Cessna 300 Nav/Com (Type RT-385A), Operating Controls and Indicators (Sheet 2 of 3)

17. NAV/TO-FROM INDICATOR - Operates only with a VOR or localizer signal. Red NAV position (Flag) indicates unusable signal. With usable VOR signal, indicates whether selected course is TO or FROM station. With usable localizer signal, shows TO.
18. RECIPROCAL COURSE INDEX - Indicates reciprocal of selected VOR course.
19. OMNI BEARING SELECTOR (OBS) - Rotates course card to select desired course.
20. AUTOMATIC RADIAL CENTERING (ARC-PUSH-TO/PULL-FR) SELECTOR - In center detent, functions as conventional OBS. Pushed to inner (Momentary On) position, turns OBS course card to center course deviation pointer with a TO flag, then returns to conventional OBS selection. Pulled to outer detent, continuously drives OBS course card to indicate bearing from VOR station, keeping course deviation pointer centered, with a FROM flag. ARC function will not operate on localizer frequencies.
21. AUTOMATIC RADIAL CENTERING (ARC) LAMP - Amber light illuminates when Automatic Radial Centering is in use. Light dimming is only available when installed with an audio control panel incorporating the annunciator lights DAY/NITE selector switch.
22. COURSE CARD - Indicates selected VOR course under course index.

Figure 1. Cessna 300 Nav/Com (Type RT-385A), Operating Controls and Indicators (Sheet 3 of 3)

The Cessna 300 Nav/Com incorporates a variable threshold automatic squelch. With this squelch system, you set the threshold level for automatic operation - the further clockwise the lower the threshold - or the more sensitive the set. When the signal is above this level, it is heard even if the noise is very close to the signal. Below this level, the squelch is fully automatic so when the background noise is very low, very weak signals (that are above the noise) are let through. For normal operation of the squelch circuit, just turn the squelch clockwise until noise is heard - then back off slightly until it is quiet, and you will have automatic squelch with the lowest practical threshold. This adjustment should be rechecked periodically during each flight to assure optimum reception.

All controls for the Nav/Com, except the standard omni bearing selector (OBS) knob or the optional automatic radial centering (ARC) knob located on the course deviation indicator, are mounted on the front panel of the receiver-transmitter. Operation and description of the audio control panels used in conjunction with this radio are shown and described in another supplement in this section.

SECTION 2

LIMITATIONS

There is no change to the airplane limitations when this avionic equipment is installed.

SECTION 3

EMERGENCY PROCEDURES

There is no change to the airplane emergency procedures when this avionic equipment is installed. However, if the frequency readouts fail, the radio will remain operational on the last frequency selected. The frequency control should not be moved due to the difficulty of obtaining a known frequency under this condition.

SECTION 4

NORMAL PROCEDURES

COMMUNICATION RECEIVER-TRANSMITTER OPERATION:

1. COM OFF/VOL Control -- TURN ON; adjust to desired audio level.
2. XMTR SEL Switch (on audio control panel) -- SET to desired Nav/Com Radio.
3. SPEAKER/PHONE Selector Switches (on audio control panel) -- SET to desired mode.
4. 5-0 Fractional MHz Selector Switch -- SELECT desired operating frequency (does not affect navigation frequencies).
5. COM Frequency Selector Switch -- SELECT desired operating frequency.
6. SQ Control -- ROTATE counterclockwise to just eliminate background noise. Adjustment should be checked periodically to assure optimum reception.
7. Mike Button:
 - a. To Transmit -- DEPRESS and SPEAK into microphone.

NOTE

Sidetone may be selected by placing the AUTO selector switch (on audio control panel) in either the SPEAKER or PHONE position. Sidetone may be eliminated by placing the AUTO selector switch in the OFF position. Adjustment of sidetone on audio control panels supplied with three transmitters cannot be accomplished externally. However, audio control panels supplied with two or less transmitters have sidetone adjustment pots that are accessible through the front of the audio control panel with a small, screwdriver.

- b. To Receive -- RELEASE mike button.

NAVIGATION OPERATION:

NOTE

The pilot should be aware that on many Cessna airplanes equipped with the windshield mounted glide slope antenna, pilots should avoid use of 2700 ± 100 RPM on airplanes equipped with a two-bladed propeller or 1800 ± 100 RPM on airplanes equipped with a three-bladed propeller during ILS approaches to avoid oscillations of the glide slope deviation pointer caused by propeller interference.

1. COM OFF/VOL Control -- TURN ON.
2. SPEAKER/PHONE Selector Switches (on audio control panel) -- SET to desired mode.
3. NAV Frequency Selector Knobs -- SELECT desired operating frequency.
4. NAV VOL -- ADJUST to desired audio level.
5. ID-VOX-T Switch:
 - a. To Identify Station -- SET to ID to hear navigation station identifier signal.
 - b. To Filter Out Station Identifier Signal -- SET to VOX to include filter in audio circuit.
6. ARC PUSH-TO/PULL-FROM Knob (If Applicable):
 - a. To Use As Conventional OBS -- PLACE in center detent and select desired course.
 - b. To Obtain Bearing TO VOR Station -- PUSH (ARC/PUSH-TO) knob to inner (momentary on) position.

NOTE

ARC lamp will illuminate amber while the course card is moving to center with the course deviation pointer. After alignment has been achieved to reflect bearing to VOR, automatic radial centering will automatically shut down, causing the ARC lamp to go out.

- c. To Obtain Continuous Bearing FROM VOR Station -- PULL (ARC/PULL-FR) knob to outer detent.

NOTE

ARC lamp will illuminate amber, OBS course card will turn to center the course deviation pointer with a FROM flag to indicate bearing from VOR station.

7. OBS Knob (If Applicable) -- SELECT desired course.

VOR SELF-TEST OPERATION:

1. COM OFF/VOL Control -- TURN ON.
2. NAV Frequency Selector Switches -- SELECT usable VOR station signal.
3. OBS Knob -- SET for 0° course at course index; course deviation pointer centers or deflects left or right, depending on bearing of signal; NAV/TO-FROM indicator shows TO or FROM.
4. ID/VOX/T Switch -- PRESS to T and HOLD at T; course deviation pointer centers and NAV/TO-FROM indicator shows FROM.
5. OBS Knob -- TURN to displace course approximately 10° to either side of 0° (while holding ID/VOX/T to T). Course deviation pointer deflects full scale in direction corresponding to course displacement. NAV/TO-FROM indicator shows FROM.

NOTE

When the 300 NAV/COM is coupled to the ANS-351C RNAV system the TEST operation is non-functional. Refer to the "Ground Check Procedures" in the Area Navigation System (Type ANS-351C) Supplement in this section to verify VOR operation of the CDI.

6. ID/VOX/T Switch -- RELEASE for normal operation.

NOTE

This test does not fulfill the requirements of FAR 91.25.

SECTION 5

PERFORMANCE

There is no change to the airplane performance when this avionic equipment is installed. However, the installation of an externally mounted antenna or several related external antennas, will result in a minor reduction in cruise performance.

SUPPLEMENT

CESSNA 300 NAV/COM (Type RT-385A)

WITH

CESSNA 400 AREA NAVIGATION SYSTEM (Type RN-478A)

SECTION 1 GENERAL

The Cessna 300 Nav/Com (Type RT-385A) Set with Cessna 400 Area Navigation (RNAV-Type RN-478A) consists of a RT-385A Nav/Com, a R-476A DME system, a RN-478A Area Navigation Computer and a IN-442AR Course Deviation Indicator. The RN-478A includes circuits which combine the VOR navigation information with distance information from the R-476A DME system to provide data for area navigation. Operating information for the communication set and for VOR/localizer navigation is presented in this supplement. Operating information for area navigation and for DME is presented in separate supplements.

The RT-385A Receiver-Transmitter includes a 720-channel VHF communication receiver-transmitter which receives and transmits signals between 118.000 MHz and 135.975 MHz in 25-kHz steps. It also includes a 200-channel VHF navigation receiver which receives VOR and localizer signals between 108.00 MHz and 117.95 MHz in 50-kHz steps. The communication receiver-transmitter and the navigation receiver can be operated simultaneously.

The VOR or localizer signal from the No. 2 Navigation Receiver is applied to the converter circuits in the RN-478A Area Navigation Compu-

ter. The converter processes the received navigation signal to provide omni bearing or localizer information for display by the course indicator.

CAUTION

If the RNAV set is removed from the airplane or becomes inoperative, the associated VHF navigation indicator will be inoperative.

The course indicator includes a Course Deviation Indicator (CDI), an Omni Bearing Selector (OBS) and OFF/TO-FROM Indicator Flags. It also includes an RNAV lamp (RN) which lights when area navigation operation is selected, and a back-course lamp (BC) which lights when back-course operation is selected. The IN-442AR is offered as the standard Course Deviation Indicator.

All operating controls and indicators for the Cessna 400 Nav/Com are included on the front panel of the RT-485A Receiver-Transmitter and the associated Course Deviation Indicator. These controls and indicators are shown and described in Figure 1. Operating controls for the RN-478A Area Navigation Computer, which are used for area navigation, and operating controls for the associated Type R-476A DME are shown in the appropriate supplements in this manual. Operating controls for the audio control panels used in conjunction with this radio are shown and described in another supplement in this section.

SECTION 2 LIMITATIONS

There is no change to the airplane limitations when this avionic equipment is installed.

SECTION 3 EMERGENCY PROCEDURES

There is no change to the airplane emergency procedures when this avionic equipment is installed. However, if the frequency readouts fail, the radio will remain operational on the last frequency selected. The frequency controls should not be moved due to the difficulty of obtaining a known frequency under this condition.

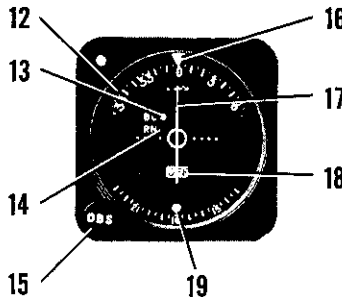
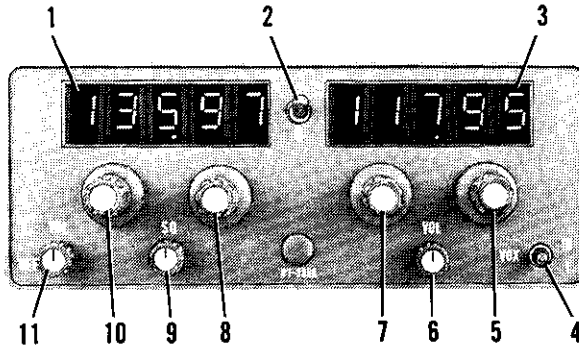

1. COMMUNICATION OPERATING FREQUENCY READOUT (Third-decimal-place is shown by the position of the "5-0" switch).
2. 5-0 SWITCH - Part of COM Receiver-Transmitter Fractional MHz Frequency Selector. In "5" position, enables COM frequency readout to display and COM Fractional MHz Selector to select frequency in .05 MHz steps between .025 and .975 MHz. In "0" position, enables COM frequency readout to display and COM Fractional MHz Selector to select frequency in .05 MHz steps between .000 and .950 MHz.

NOTE

The "5" or "0" may be read as the third decimal digit, which is not displayed in the Com fractional frequency display.

Figure 1. Cessna 300 Nav/Com Set, Operating Controls and Indicators
(Sheet 1 of 3)

3. NAVIGATION OPERATING FREQUENCY READOUT.
4. ID-VOX-T SWITCH - With VOR or LOC station selected, in ID position, station identifier signal is audible; in center VOX (Voice) position, identifier signal is suppressed; in T (Momentary On) position, the VOR navigational self-test function is selected.
5. NAVIGATIONAL RECEIVER FRACTIONAL MEGAHERTZ FREQUENCY SELECTOR - Selects NAV frequency in .05 MHz steps between .00 and .95 MHz; simultaneously selects paired glide slope frequency and DME channel.
6. NAV VOLUME CONTROL (VOL) - Adjusts volume of navigation receiver audio. Clockwise rotation increases audio level.
7. NAVIGATION RECEIVER MEGAHERTZ FREQUENCY SELECTOR - Selects NAV frequency in 1-MHz steps between 108 and 117 MHz; simultaneously selects paired glide slope frequency and DME channel.
8. COMMUNICATION RECEIVER-TRANSMITTER FRACTIONAL MHz FREQUENCY SELECTOR - Depending on position of the 5-0 Switch, selects COM frequency in .05 MHz steps between .000 and .975 MHz. The 5-0 switch identifies the last digit as either 5 or 0.
9. SQUELCH CONTROL - Used to adjust signal threshold necessary to activate COM receiver audio. Clockwise rotation increases background noise (decreases squelch action); counterclockwise rotation decreases background noise.
10. COMMUNICATION RECEIVER-TRANSMITTER MHz FREQUENCY SELECTOR - Selects COM frequency in 1 MHz steps between 118 and 135 MHz.
11. COM OFF-VOL CONTROL - Combination on/off switch and volume control; turns on NAV/COM Set and RNAV Computer circuits; controls volume of communication receiver audio.
12. COURSE CARD - Indicates selected VOR course under course index.
13. BACK COURSE LAMP (BC) - Amber light illuminates when an autopilot with reverse sense feature is installed and the reverse sense switch or the autopilot's back-course function is engaged and receiver is tuned to a localizer frequency; indicates course deviation pointer is reversed. BC light dimming is only available when installed with an audio control panel incorporating the annunciator lights DAY/NITE selector switch.
14. AREA NAV LAMP (RN) - When green light is illuminated, indicates that RNAV operation is selected. RN light dimming is only available when installed with an audio control panel incorporating the annunciator lights DAY/NITE selector switch.
15. OMNI BEARING SELECTOR (OBS) - Rotates course card (12) to select desired bearing to or from a VOR station or to a selected RNAV waypoint.

Figure 1. Cessna 300 Nav/Com Set, Operating Controls and Indicators
(Sheet 2 of 3)

16. COURSE INDEX - Indicates selected VOR or RNAV course (bearing).
17. COURSE DEVIATION POINTER - Indicates deviation from selected VOR or RNAV course or localizer centerline.
18. OFF/TO-FROM INDICATOR - Operates only with VOR or localizer signal. OFF position (flag) indicates unusable signal. With usable VOR signal, when OFF position disappears, indicates whether selected course is TO or FROM station or waypoint. With usable localizer signal, shows TO.
19. RECIPROCAL COURSE INDEX - Indicates reciprocal of selected VOR or RNAV course.

Figure 1. Cessna 300 Nav/Com Set, Operating Controls and Indicators
(Sheet 3 of 3)

SECTION 4

NORMAL PROCEDURES

COMMUNICATIONS OPERATION:

1. COM OFF/VOL Control -- TURN ON; adjust to desired audio level.
2. XMTR SEL Switch (on audio control panel)-- SET to desired 300 NAV/COM.
3. SPEAKER PHONE Selector Switches (on audio control panel) -- SET to desired mode.
4. 5-0 Fractional MHz Selector Switch -- SELECT desired operating frequency (does not affect navigation frequencies).
5. COM Frequency Selector Knobs -- SELECT desired operating frequency.
6. SQ Control -- ROTATE counterclockwise to just eliminate background noise.
7. Mike Button:
 - a. To Transmit -- DEPRESS and SPEAK into microphone.

NOTE

Sidetone may be selected by placing the AUTO selector switch (on audio control panel) in either the SPEAKER or PHONE position, or may be eliminated by placing the AUTO selector switch in the OFF position. Adjustment of sidetone on audio control panels supplied with three transmitters cannot be accomplished externally. However, audio control panels supplied with one or two transmitters have sidetone adjustment pots that are accessible through the front of the audio control panel with a small screwdriver.

- b. To Receive -- RELEASE mike button.

NAVIGATION

NOTE

The pilot should be aware that on many Cessna airplanes equipped with the windshield mounted glide slope antenna, pilots should avoid use of 2700 \pm 100 RPM on airplanes equipped with a two-bladed propeller or 1800 \pm 100 RPM on airplanes equipped with a three-bladed propeller during ILS approaches to avoid oscillations of the glide slope deviation pointer caused by propeller interference.

1. COM OFF/VOL Control -- TURN ON.
2. SPEAKER/PHONE Selector Switches (on audio control panel) -- SET to desired mode.
3. NAV Frequency Selector Knobs -- SELECT desired operating frequency.
4. NAV VOL Control -- ADJUST to desired audio level.
5. ID-VOX-T Switch:
 - a. To Identify Station -- SET to ID to hear navigation station identifier (Morse Code) signal.
 - b. To Filter Out Station Identifier Signal -- SET to VOX (center) position to include filter in audio circuit.
6. OBS Knob -- SELECT desired course.

TO SELF TEST VOR NAVIGATION CIRCUITS:

1. COM OFF/VOL Control -- TURN ON.
2. NAV Frequency Selector Switches -- SELECT usable VOR station signal.
3. OBS Knob -- SET for 0° course at index; CDI pointer centers or deflects left or right, depending on bearing of signal; OFF/TO-FROM indicator shows TO or FROM.
4. ID-VOX-T Switch -- PRESS to T and HOLD at T; CDI pointer should center and OFF/TO-FROM indicator should show FROM.
5. OBS Knob -- TURN to displace course approximately 10° to either side of 0° (while holding ID-VOX-T switch at T); CDI pointer should deflect full scale in direction corresponding to course displacement. OFF/TO-FROM indicator should still show FROM.

NOTE

This test does not fulfill the requirements of FAR 91.25.

SECTION 5

PERFORMANCE

There is no change to the airplane performance when this avionic equipment is installed. However, the installation of an externally mounted antenna or several related external antennas, will result in a minor reduction in cruise performance.

SUPPLEMENT

CESSNA 300 TRANSPONDER (Type RT-359A) AND OPTIONAL ALTITUDE ENCODER (BLIND)

SECTION 1

GENERAL

The Cessna 300 Transponder (Type RT-359A), shown in Figure 1, is the airborne component of an Air Traffic Control Radar Beacon System (ATCRBS). The transponder enables the ATC ground controller to "see" and identify the aircraft, while in flight, on the control center's radarscope more readily.

The Cessna 300 Transponder system consists of a panel-mounted unit, an externally-mounted antenna and an optional control wheel-mounted XPDR IDENT switch. The transponder receives interrogating pulse signals on 1030 MHz and transmits pulse-train reply signals on 1090 MHz. The transponder is capable of replying to Mode A (aircraft identification) and also to Mode C (altitude reporting) when coupled to an optional altitude encoder system. The transponder is capable of replying on both modes of interrogation on a selective reply basis on any of 4096 information code selections. The optional altitude encoder system (not part of a standard 300 Transponder system) required for Mode C (altitude reporting) operation consists of a completely independent remote-mounted digitizer that is connected to the static system and supplies encoded altitude information to the transponder. When the altitude encoder system is coupled to the 300 Transponder system, altitude reporting capabilities are available in 100-foot increments between -1000 and +20,000 feet.

All Cessna 300 Transponder operating controls, with the exception of the optional XPDR IDENT switch, are located on the front panel of the unit. The remote XPDR IDENT switch is located on the right hand grip of the pilot's control wheel. Functions of the operating controls are described in Figure 1.

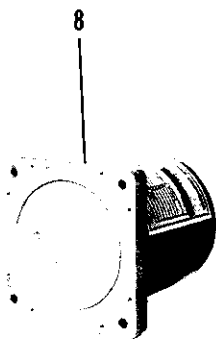
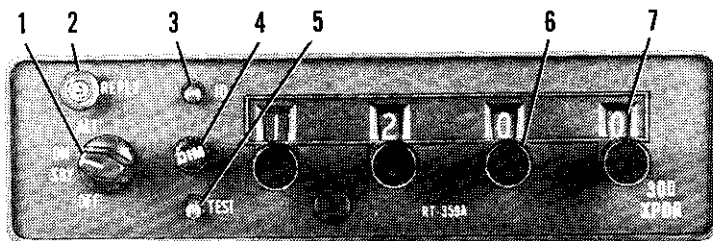

1. **FUNCTION SWITCH** - Controls application of power and selects transponder operating mode as follows:
 - OFF - Turns set off.
 - SBY - Turns set on for equipment warm-up or standby power.
 - ON - Turns set on and enables transponder to transmit Mode A (aircraft identification) reply pulses.
 - ALT - Turns set on and enables transponder to transmit either Mode A (aircraft identification) reply pulses or Mode C (altitude reporting) pulses selected automatically by the interrogating signal.

Figure 1. Cessna 300 Transponder and Altitude Encoder (Blind)
(Sheet 1 of 2)

PILOT'S OPERATING HANDBOOK CESSNA 300 TRANSPONDER
SUPPLEMENT AND ALTITUDE ENCODER (BLIND)

2. REPLY LAMP - Lamp flashes to indicate transmission of reply pulses; glows steadily to indicate transmission of IDENT pulse or satisfactory self-test operation. (Reply lamp will also glow steadily during initial warm-up period.)
3. IDENT (ID) SWITCH - When depressed, selects special pulse identifier to be transmitted with transponder reply to effect immediate identification of aircraft on ground controller's display. (Reply lamp will glow steadily during duration of IDENT pulse transmission.)
4. DIMMER (DIM) CONTROL - Allows pilot to control brilliance of reply lamp.
5. SELF-TEST (TST) SWITCH - When depressed, causes transponder to generate a self-interrogating signal to provide a check of transponder operation. (Reply lamp will glow steadily to verify self-test operation.)
6. REPLY-CODE SELECTOR KNOBS (4) - Select assigned Mode A reply code.
7. REPLY-CODE INDICATORS (4) - Display selected Mode A reply code.
8. REMOTE-MOUNTED DIGITIZER - Provides an altitude reporting code range of -1000 feet up to the airplane's maximum service ceiling.
9. REMOTE ID SWITCH (XPDR IDENT) - Same as panel-mounted ID switch described in Item 3.

Figure 1. Cessna 300 Transponder and Altitude Encoder (Blind)
(Sheet 2 of 2)

SECTION 2

LIMITATIONS

There is no change to the airplane limitations when this avionic equipment is installed. However, the following information must be displayed in the form of a placard located near the altimeter.

ALTITUDE ENCODER EQUIPPED

SECTION 3

EMERGENCY PROCEDURES

TO TRANSMIT AN EMERGENCY SIGNAL:

1. Function Switch -- ON.
2. Reply-Code Selector Knobs -- SELECT 7700 operating code.

TO TRANSMIT A SIGNAL REPRESENTING LOSS OF ALL COMMUNICATIONS (WHEN IN A CONTROLLED ENVIRONMENT):

1. Function Switch -- ON.
2. Reply-Code Selector Knobs -- SELECT 7700 operating code for 1 minute; then SELECT 7600 operating code for 15 minutes and then REPEAT this procedure at same intervals for remainder of flight.

SECTION 4

NORMAL PROCEDURES

BEFORE TAKEOFF:

1. Function Switch -- SBY.

TO TRANSMIT MODE A (AIRCRAFT IDENTIFICATION) CODES IN FLIGHT:

1. Reply-Code Selector Knobs -- SELECT assigned code.

2. Function Switch -- ON.
3. DIM Control -- ADJUST light brilliance of reply lamp.

NOTE

During normal operation with function switch in ON position, reply lamp flashes indicating transponder replies to interrogations.

4. ID or XPDR IDENT Button -- DEPRESS momentarily when instructed by ground controller to "squawk IDENT" (reply lamp will glow steadily, indicating IDENT operation).

TO TRANSMIT MODE C (ALTITUDE REPORTING) CODES IN FLIGHT:

1. Reply-Code Selector Knobs -- SELECT assigned code.
2. Function Switch -- ALT.

NOTE

When directed by ground controller to "stop altitude squawk", turn Function Switch to ON for Mode A operation only.

NOTE

Pressure altitude is transmitted by the transponder for altitude squawk and conversion to indicated altitude is done in ATC computers. Altitude squawked will only agree with indicated altitude when the local altimeter setting in use by the ground controller is set in the aircraft altimeter.

3. DIM Control -- ADJUST light brilliance of reply lamp.

TO SELF-TEST TRANSPONDER OPERATION:

1. Function Switch -- SBY and wait 30 seconds for equipment to warm-up.
2. Function Switch -- ON or ALT.
3. TST Button -- DEPRESS (reply lamp should light brightly regardless of DIM control setting).
4. TST Button -- RELEASE for normal operation.

SECTION 5 PERFORMANCE

There is no change to the airplane performance when this avionic equipment is installed. However, the installation of an externally mounted antenna or several related external antennas, will result in a minor reduction in cruise performance.

SUPPLEMENT

CESSNA 300 TRANSPONDER **(Type RT-359A)**

AND

OPTIONAL ENCODING ALTIMETER **(Type EA-401A)**

SECTION 1

GENERAL

The Cessna 300 Transponder (Type RT-359A), shown in Figure 1, is the airborne component of an Air Traffic Control Radar Beacon System (ATCRBS). The transponder enables the ATC ground controller to "see" and identify the aircraft, while in flight, on the control center's radarscope more readily.

The Cessna 300 Transponder system consists of a panel-mounted unit, an externally-mounted antenna and an optional control wheel-mounted XPDR IDENT switch. The transponder receives interrogating pulse signals on 1030 MHz and transmits pulse-train reply signals on 1090 MHz. It is capable of replying to Mode A (aircraft identification) and also to Mode C (altitude reporting) interrogations on a selective reply basis on any of 4096 information code selections. When an optional panel-mounted EA-401A Encoding Altimeter (not part of a standard 300 Transponder system) is included in the avionics configuration, the transponder can provide altitude reporting in the 100-foot increments between -1000 and +35,000 feet.

All Cessna 300 Transponder operating controls, with the exception of the optional altitude encoder's altimeter setting knob and the optional remote XPDR IDENT switch, are located on the front panel of the unit. The altimeter setting knob is located on the encoding altimeter and the remote XPDR IDENT switch is located on the right hand grip of the pilot's control wheel. Functions of the operating controls are described in Figure 1.

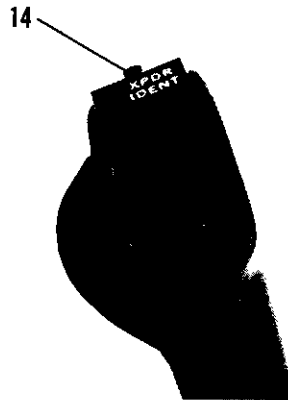
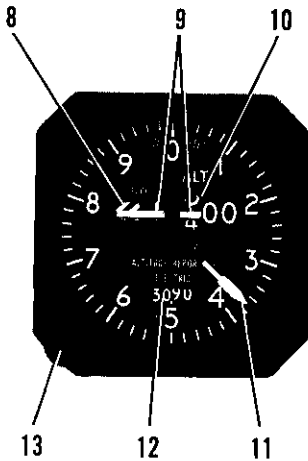
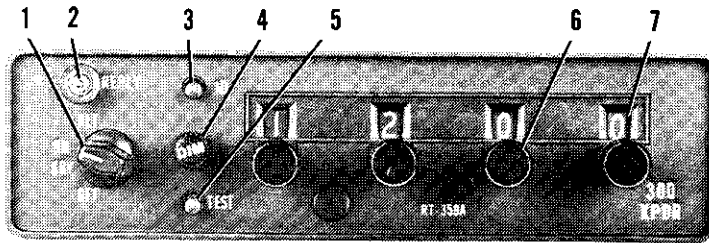

1. **FUNCTION SWITCH** - Controls application of power and selects transponder operating mode as follows:
 - OFF - Turns set off.
 - SBY - Turns set on for equipment warm-up or stand-by power.
 - ON - Turns set on and enables transponder to transmit Mode A (aircraft identification) reply pulses.
 - ALT - Turns set on and enables transponder to transmit either Mode A (aircraft identification) reply pulses or Mode C (altitude reporting) pulses selected automatically by the interrogating signal.

Figure 1. Cessna 300 Transponder and Encoding Altimeter (Sheet 1 of 2)

2. REPLY LAMP - Lamp flashes to indicate transmission of reply pulses; glows steadily to indicate transmission of IDENT pulse or satisfactory self-test operation. (Reply lamp will also glow steadily during initial warm-up period.)
3. IDENT (ID) SWITCH - When depressed, selects special pulse identifier to be transmitted with transponder reply to effect immediate identification of aircraft on ground controller's display. (Reply lamp will glow steadily during duration of IDENT pulse transmission.)
4. DIMMER (DIM) CONTROL - Allows pilot to control brilliance of reply lamp.
5. SELF-TEST (TST) SWITCH - When depressed, causes transponder to generate a self-interrogating signal to provide a check of transponder operation. (Reply lamp will glow steadily to verify self-test operation.)
6. REPLY-CODE SELECTOR KNOBS (4) - Select assigned Mode A reply code.
7. REPLY-CODE INDICATORS (4) - Display selected Mode A reply code.
8. 1000-FOOT DRUM TYPE INDICATOR - Provides digital altitude readout in 1000-foot increments between -1000 feet and +35,000 feet. When altitude is below 10,000 feet, a diagonally striped flag appears in the 10,000 foot window.
9. OFF INDICATOR WARNING FLAG - Flag appears across altitude readout when power is removed from the altimeter to indicate that readout is not reliable.
10. 100-FOOT DRUM TYPE INDICATOR - Provides digital altitude readout in 100-foot increments between 0 and 1000 feet.
11. 20-FOOT INDICATOR NEEDLE - Indicates altitude in 20-foot increments between 0 feet and 1000 feet.
12. ALTIMETER SETTING SCALE - DRUM TYPE - Indicates selected altimeter setting in the range of 27.9 to 31.0 inches of mercury on the standard altimeter or 950 to 1050 millibars on the optional altimeter.
13. ALTIMETER SETTING KNOB - Dials in desired altimeter setting in the range of 27.9 to 31.0 inches of mercury on the standard altimeter or 950 to 1050 millibars on the optional altimeter.
14. REMOTE ID SWITCH (XPDR IDENT) - Same as panel-mounted ID switch described in Item 3.

Figure 1. Cessna 300 Transponder and Encoding Altimeter (Sheet 2 of 2)

SECTION 2

LIMITATIONS

There is no change to the airplane performance when this avionic equipment is installed. However, the encoding altimeter used in this installation does have a limitation that requires a standard barometric altimeter to be installed as a back-up altimeter.

SECTION 3

EMERGENCY PROCEDURES

TO TRANSMIT AN EMERGENCY SIGNAL:

1. Function Switch -- ON.
2. Reply-Code Selector Knobs -- SELECT 7700 operating code.

TO TRANSMIT A SIGNAL REPRESENTING LOSS OF ALL COMMUNICATIONS (WHEN IN A CONTROLLED ENVIRONMENT):

1. Function Switch -- ON.
2. Reply-Code Selector Knobs -- SELECT 7700 operating code for 1 minute; then SELECT 7600 operating code for 15 minutes and then REPEAT this procedure at same intervals for remainder of flight.

SECTION 4

NORMAL PROCEDURES

BEFORE TAKEOFF:

1. Function Switch -- SBY.

TO TRANSMIT MODE A (AIRCRAFT IDENTIFICATION) CODES IN FLIGHT:

1. Reply-Code Selector Knobs -- SELECT assigned code.

2. Function Switch -- ON.
3. DIM Control -- ADJUST light brilliance of reply lamp.

NOTE

During normal operation with function switch in ON position, reply lamp flashes indicating transponder replies to interrogations.

4. ID or XPDR IDENT Button -- DEPRESS momentarily when instructed by ground controller to "squawk IDENT" (reply lamp will glow steadily, indicating IDENT operation).

TO TRANSMIT MODE C (ALTITUDE REPORTING) CODES IN FLIGHT:

1. Off Indicator Warning Flag -- VERIFY that flag is out of view on encoding altimeter.
2. Altitude Encoder Altimeter Setting Knob -- SET IN assigned local altimeter setting.
3. Reply-Code Selector Knobs -- SELECT assigned code.
4. Function Switch -- ALT.

NOTE

When directed by ground controller to "stop altitude squawk", turn Function Switch to ON for Mode A operation only.

NOTE

Pressure altitude is transmitted by the transponder for altitude squawk and conversion to indicated altitude is done in ATC computers. Altitude squawked will only agree with indicated altitude when the local altimeter setting in use by the ground controller is set in the encoding altimeter.

5. DIM Control -- ADJUST light brilliance of reply lamp.

TO SELF-TEST TRANSPONDER OPERATION:

1. Function Switch -- SBY and wait 30 seconds for equipment to warm-up.
2. Function Switch -- ON or ALT.

3. TST Button -- DEPRESS and HOLD (reply lamp should light with full brilliance regardless of DIM control setting).
4. TST Button -- RELEASE for normal operation.

SECTION 5

PERFORMANCE

There is no change to the airplane performance when this avionic equipment is installed. However, the installation of an externally mounted antenna or several related external antennas, will result in a minor reduction in cruise performance.

SUPPLEMENT

CESSNA NAVOMATIC 300A AUTOPILOT (Type AF-395A)

SECTION 1 GENERAL

The Cessna 300A Navomatic is an all electric, single-axis (aileron control) autopilot system that provides added lateral and directional stability. Components are a computer-amplifier, a turn coordinator, a directional gyro, an aileron actuator and a course deviation indicator(s) incorporating a localizer reversed (BC) indicator light.

Roll and yaw motions of the airplane are sensed by the turn coordinator gyro. Deviations from the selected heading are sensed by the directional gyro. The computer-amplifier electronically computes the necessary correction and signals the actuator to move the ailerons to maintain the airplane in the commanded lateral attitude or heading.

The actuator includes a thermostatic switch which monitors the operating temperature of the motor. If the temperature becomes abnormal, the thermostatic switch opens and disengages the autopilot to remove power from the actuator. After approximately 10 minutes, the switch will automatically close to reapply power to the actuator and autopilot system.

The 300A Navomatic will also intercept and track a VOR or localizer course using signals from a VHF navigation receiver.

The operating controls for the Cessna 300A Navomatic are located on the front panel of the computer-amplifier and on the directional gyro, shown in Figure 1. The primary function pushbuttons (HDG SEL, NAV INT, and NAV TRK), are interlocked so that only one function can be selected at a time. The HI SENS and BACK CRS pushbuttons are not interlocked so that either or both of these functions can be selected at any time.

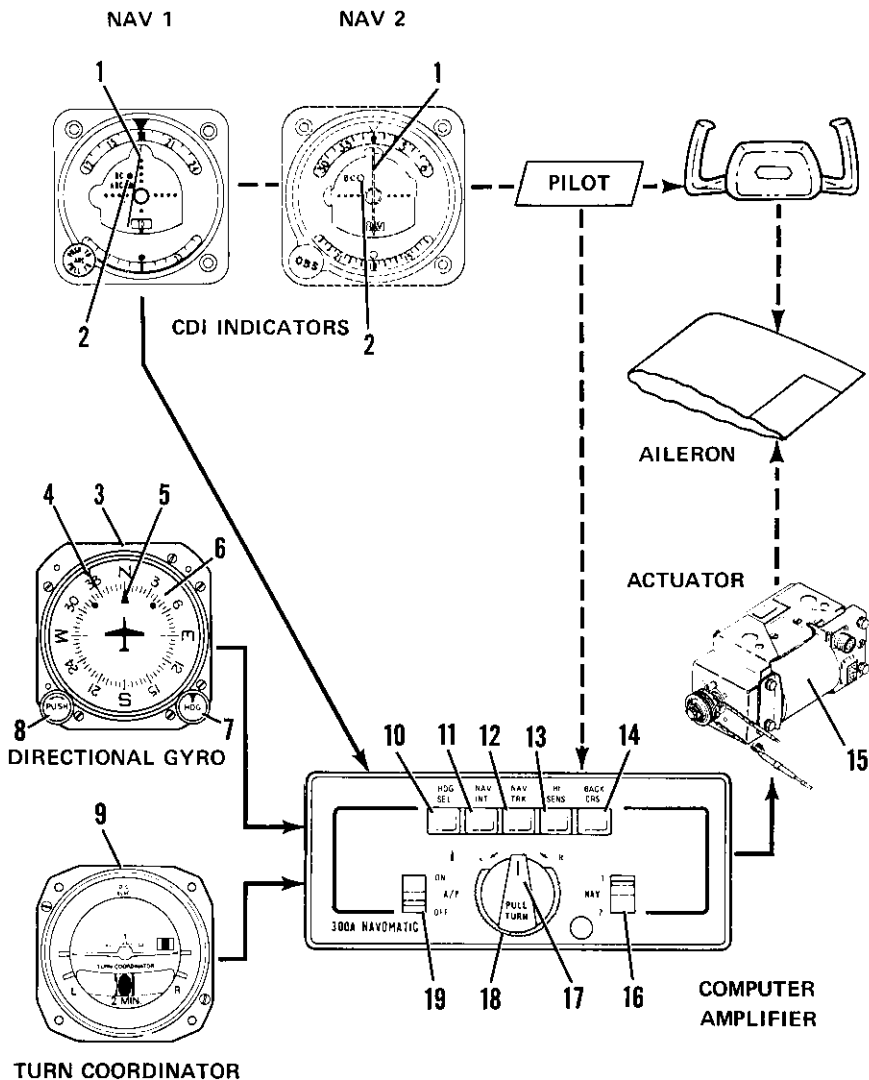

Figure 1. Cessna 300A Autopilot, Operating Controls and Indicators
 (Sheet 1 of 3)

1. COURSE DEVIATION INDICATOR - Provides VOR/LOC navigation inputs to autopilot for intercept and tracking modes.
2. LOCALIZER REVERSED INDICATOR LIGHT - Amber light, labeled BC, illuminates when BACK CRS button is pushed in (engaged) and LOC frequency selected. BC light indicates course indicator needle is reversed on selected receiver (when tuned to a localizer frequency). This light is located within the CDI indicator.
3. NON-SLAVED DIRECTIONAL GYRO - Provides a stable visual indication of aircraft heading to the pilot and provides heading information to the autopilot for heading intercept and hold.
4. HEADING BUG - Moved by HDG knob to select desired heading.
5. LUBBER LINE - Indicates aircraft heading on compass card (6).
6. COMPASS CARD - Rotates to display heading of airplane with reference to lubber line (5).
7. HEADING SELECTOR KNOB (HDG) - When pushed in, the heading bug (4) may be positioned to the desired magnetic heading by rotating the HDG selector knob. Also used to select VOR or LOC course.
8. GYRO ADJUSTMENT KNOB (PUSH) - When pushed in, allows the pilot to manually rotate the compass card (6) to correspond with the magnetic heading indicated by the compass. The compass card must be manually reset periodically to compensate for precessional errors in the gyro.
9. TURN COORDINATOR - Senses roll and yaw for wings leveling and command turn functions.
10. HDG SEL PUSHBUTTON - Aircraft will turn to and hold heading selected by the heading "bug" on the directional gyro.
11. NAV INT PUSHBUTTON - When heading "bug" on DG is set to selected course, aircraft will turn to and intercept selected VOR or LOC course.
12. NAV TRK PUSHBUTTON - When heading "bug" on DG is set to selected course, aircraft will track selected VOR or LOC course.
13. HI SENS PUSHBUTTON - During NAV INT or NAV TRK operation, this high sensitivity setting increases autopilot response to NAV signal to provide more precise operation during localizer approach. In low-sensitivity position (push-button out), response to NAV signal is dampened for smoother tracking of enroute VOR radials; it also smooths out effect of course scalloping during NAV operation.
14. BACK CRS PUSHBUTTON - Used with LOC operation only. With A/P switch OFF or ON, and when navigation receiver selected by NAV switch is set to a localizer frequency, it reverses normal localizer needle indication (CDI) and causes localizer reversed (BC) light to illuminate. With A/P switch ON, reverses localizer signal to autopilot.

Figure 1. Cessna 300A Autopilot, Operating Controls and Indicators
(Sheet 2 of 3)

15. ACTUATOR - The torque motor in the actuator causes the ailerons to move in the commanded direction.
16. NAV SWITCH - Selects NAV 1 or NAV 2 navigation receiver.
17. PULL TURN KNOB - When pulled out and centered in detent, airplane will fly wings-level; when turned to the right (R), the airplane will execute a right, standard rate turn; when turned to the left (L), the airplane will execute a left, standard rate turn. When centered in detent and pushed in, the operating mode selected by a pushbutton is engaged.
18. TRIM - Used to trim autopilot to compensate for minor variations in aircraft trim or lateral weight distribution. (For proper operation, the aircraft's rudder trim, if so equipped, must be manually trimmed before the autopilot is engaged.)
19. A/P SWITCH - Turns autopilot ON or OFF.

Figure 1. Cessna 300A Autopilot, Operating Controls and Indicators
(Sheet 3 of 3)

SECTION 2 LIMITATIONS

The following autopilot limitation must be adhered to:

BEFORE TAKE-OFF AND LANDING:

1. A/P ON-OFF Switch -- OFF.

SECTION 3 EMERGENCY PROCEDURES

TO OVERRIDE THE AUTOPILOT:

1. Airplane Control Wheel -- ROTATE as required to override autopilot.

NOTE

The servo may be overpowered at any time without damage.

TO TURN OFF AUTOPILOT:

1. A/P ON-OFF Switch -- OFF.

SECTION 4 NORMAL PROCEDURES

BEFORE TAKE-OFF AND LANDING:

1. A/P ON-OFF Switch -- OFF.
2. BACK CRS Button -- OFF (see Caution note under Nav Intercept).

NOTE

Periodically verify operation of amber warning light(s), labeled BC on CDI(s), by engaging BACK CRS button with a LOC frequency selected, or use TEST function on the audio control panel to verify BC light operation.

INFLIGHT WINGS LEVELING:

1. Airplane Rudder Trim -- ADJUST for zero slip ("Ball" centered on Turn Coordinator).
2. PULL-TURN Knob -- CENTER and PULL out.
3. A/P ON-OFF Switch -- ON.
4. Autopilot TRIM Control -- ADJUST for zero turn rate (wings level indication on Turn Coordinator).

NOTE

For optimum performance in airplanes equipped as float-planes, use autopilot only in cruise flight or in approach configuration with flaps down no more than 10° and airspeed no lower than 75 KIAS on 172 and R172 Series Models or 90 KIAS on 180, 185, U206 and TU206 Series Models.

COMMAND TURNS:

1. PULL-TURN Knob -- CENTER, PULL out and ROTATE.

HEADING SELECT:

1. Directional Gyro -- SET to airplane magnetic heading.
2. Heading Selector Knob -- ROTATE bug to desired heading.
3. Heading Select Button -- PUSH.
4. PULL-TURN Knob -- CENTER and PUSH.

NOTE

Airplane will turn automatically to selected heading. If airplane fails to hold the precise heading, readjust autopilot TRIM control as required or disengage autopilot and reset manual rudder trim (if installed).

NAV INTERCEPT (VOR/LOC):

1. PULL-TURN Knob -- CENTER and PULL out.
2. NAV 1-2 Selector Switch -- SELECT desired receiver.
3. Nav Receiver OBS or ARC Knob -- SET desired VOR course (if tracking omni).

NOTE

Optional ARC knob should be in center position and ARC warning light should be off.

4. Heading Selector Knob -- ROTATE bug to selected course (VOR or localizer - inbound or outbound as appropriate).
5. Directional Gyro --SET for magnetic heading.
6. NAV INT Button -- PUSH.
7. HI SENS Button -- PUSH for localizer and "close-in" omni intercepts.
8. BACK CRS Button -- PUSH only if intercepting localizer front course outbound or back course inbound.

CAUTION

With BACK CRS button pushed in and localizer frequency selected, the CDI on selected nav radio will be reversed even when the autopilot switch is OFF.

9. PULL-TURN Knob -- PUSH.

NOTE

Airplane will automatically turn to a 45° intercept angle.

NAV TRACKING (VOR/LOC):

1. NAV TRK Button -- PUSH when CDI centers (within one dot) and airplane is within $\pm 10^\circ$ of course heading.
2. HI SENS Button -- Disengage for enroute omni tracking (leave engaged for localizer).

NOTE

Optional ARC feature, if installed, should not be used for autopilot operation. If airplane should deviate off course, pull out PULL TURN knob and readjust airplane rudder trim for straight flight on the turn coordinator. Push in PULL TURN knob and reintercept the course. If deviation persists, progressively make slight adjustments of the autopilot TRIM control towards the course as required to maintain track.

SECTION 5 PERFORMANCE

There is no change to the airplane performance when this avionic equipment is installed.

SUPPLEMENT

CESSNA 400 ADF (Type R-446A)

SECTION 1 GENERAL

The Cessna 400 ADF is an automatic direction finder set which provides continuous, visual bearing indications of the direction from which an RF signal is being received. It can be used for plotting position, for homing, and for aural reception of AM signals between 200 kHz and 1699 kHz. In addition, a crystal-controlled, beat frequency oscillator (BFO) permits coded identifier of stations transmitting keyed CW signals (Morse Code) to be heard.

The basic units of the Cessna 400 ADF are a R-446A Receiver with dual frequency selectors, a goniometer-indicator (IN-346A), a sense antenna and a loop antenna. The receiver and goniometer-indicator are panel-mounted units. The sense and loop antennas are mounted on the external airplane surfaces. The goniometer-indicator presents station bearing in degrees of azimuth. An automatic pointer-stow feature alerts the operator to non-ADF operation by slewing the pointer to the 3:00 o'clock position when the REC mode is selected. Operating controls and displays for the Cessna 400 ADF are shown and described in Figure 1. The audio control panels used in conjunction with this radio for speaker-phone selection are shown and described in another supplement in this section.

The frequency range of the Cessna 400 ADF is electronically divided into three bands: 200-399 kHz, 400-799 kHz, and 800-1699 kHz. Frequency spacing within each band is in 1-kHz increments. The operating frequency and band are selected by a four-section Minilever switch which displays a digital readout of the frequency selected and supplies a binary code to control the logic circuits within the set. A secondary (standby) operating frequency is selected by another four-section Minilever switch. Frequency control of the ADF is switched to the primary or the secondary operating frequency by a toggle switch. The operating modes (ADF and REC) are selected by individual pushbutton switches. Additional pushbutton switches are used to select the BFO and to test signal reliability during ADF operation.

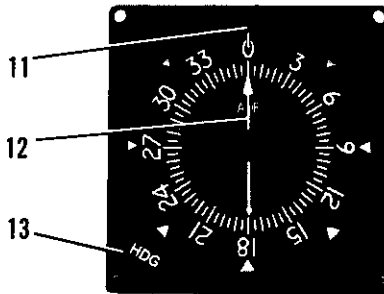
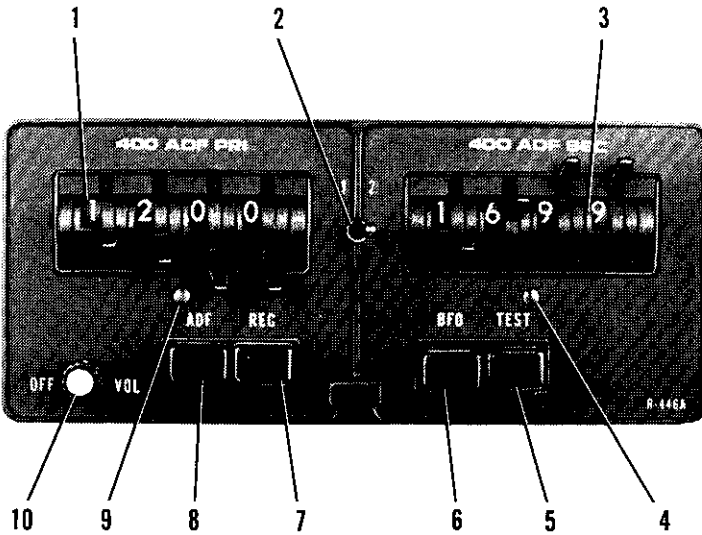

Figure 1. Cessna 400 ADF Operating Controls and Indicator
(Sheet 1 of 2)

1. PRI (PRIMARY FREQUENCY SELECTOR) - Selects and displays "primary" frequency.
2. 1-2 - The "1" position activates "primary" (PRI) frequency. The "2" position activates "secondary" (SEC) frequency.
3. SEC (SECONDARY FREQUENCY SELECTOR) - Selects and displays "secondary" frequency.
4. SECONDARY RESELECT LAMP - Lamp will flash only when "secondary" (SEC) frequency selection is outside of operating range of the receiver and 1-2 switch is in the "2" position.
5. TEST - Momentary-on switch used only with ADF function to test bearing reliability. When held depressed, slows indicator pointer; when released, if bearing is reliable, pointer returns to original position.
6. BFO - Pushed in: Activates beat frequency oscillator tone to permit coded identifier of stations transmitting keyed CW signals (Morse Code) to be heard.
7. REC - Pushed in: Selects receive mode (set operates as a standard communications receiver using sense antenna only).

NOTE

In this position an automatic pointer stow feature will alert the pilot to non-ADF operation by positioning and retaining the pointer at the 3:00 o'clock position when the 400 ADF is in the REC function.

8. ADF - Pushed in: Selects ADF mode (set operates as automatic direction finder using loop and sense antennas).
9. PRIMARY RESELECT LAMP - Lamp will flash only when "primary" (PRI) frequency selection is outside of operating range of the receiver and 1-2 switch is in the "1" position.
10. OFF-VOL - Turns set on or off and adjusts receiver volume.
11. INDEX - Fixed reference line for dial rotation adjustment.
12. POINTER - When HDG control is adjusted, indicates either relative, magnetic, or true bearings of a radio station.
13. HDG - Rotates dial to facilitate relative, magnetic, or true bearing information.

Figure 1. Cessna 400 ADF Operating Controls and Indicator
(Sheet 2 of 2)

SECTION 2 LIMITATIONS

There is no change to the airplane limitations when this avionic equipment is installed.

SECTION 3 EMERGENCY PROCEDURES

There is no change to the airplane emergency procedures when this avionic equipment is installed.

SECTION 4 NORMAL PROCEDURES

TO OPERATE AS A COMMUNICATIONS RECEIVER ONLY:

1. OFF/VOL Control -- ON.
2. REC Pushbutton -- PUSH in.

NOTE

ADF indicator pointer will stow at a 90-degree position to alert the pilot to non-ADF operation.

3. PRI Frequency Selectors -- SELECT desired operating frequency.
4. SEC Frequency Selectors -- SELECT desired operating frequency.
5. 1-2 Selector Switch -- 1 position.

NOTE

1-2 selector switch can be placed in the 2 position for operation on secondary frequency. The re-select lamp will flash only when frequency selection is outside of operating range of the receiver.

6. ADF SPEAKER/PHONE Selector Switch (on audio control panel) -- SELECT speaker or phone position.
7. VOL Control -- ADJUST to desired listening level.

TO OPERATE AS AN AUTOMATIC DIRECTION FINDER:

1. OFF/VOL Control -- ON.
2. PRI Frequency Selectors -- SELECT desired operating frequency.
3. SEC Frequency Selectors -- SELECT desired operating frequency.
4. 1-2 Selector Switch -- 1 position.

NOTE

1-2 selector switch can be placed in the 2 position for operation on secondary frequency. The re-select lamp will flash only when frequency selection is outside of operating range of the receiver.

5. ADF SPEAKER/PHONE Selector Switch (on audio control panel) -- SELECT speaker or phone position as desired.
6. ADF Pushbutton -- PUSH in and note relative bearing on ADF indicator.
7. HDG Control -- SET goniometer-indicator dial so that index indicates 0°, magnetic, or true heading of airplane. Pointer then indicates relative, magnetic, or true bearing to station.
8. VOL Control -- ADJUST to desired listening level.

NOTE

When switching stations, place function pushbutton in the REC position. Then, after station has been selected, place function pushbutton in the ADF position to resume automatic direction finder operation. (This practice prevents the bearing indicator from swinging back and forth as frequency dial is rotated.)

TO TEST RELIABILITY OF AUTOMATIC DIRECTION FINDER:

1. ADF Pushbutton -- PUSH in and note relative bearing on indicator.
2. TEST Pushbutton -- PUSH in and hold TEST button until indicator pointer slews off indicated bearing at least 10 to 20 degrees.
3. TEST Pushbutton -- RELEASE and OBSERVE that indicator pointer returns to the same relative bearing as in step (1).

TO OPERATE BFO:

1. OFF/VOL Control -- ON.
2. ADF SPEAKER/PHONE Selector Switch (on audio control panel) -- SELECT speaker or phone position as desired.
3. BFO Pushbutton -- PUSH in.
4. 1-2 Selector Switch -- SELECT 1 position to activate PRI frequency

or 2 to activate SEC frequency that is transmitting keyed CW signals (Morse Code).

5. VOL Control -- ADJUST to desired listening level.

NOTE

A 1000-Hz tone is heard in the audio output when CW signal (Morse Code) is tuned in properly.

SECTION 5 PERFORMANCE

There is no change to the airplane performance when this avionic equipment is installed. However, the installation of an externally mounted antenna or several related external antennas, will result in a minor reduction in cruise performance.

SUPPLEMENT

CESSNA 400 AREA NAVIGATION SYSTEM

(Type RN-478A)

SECTION 1 GENERAL

The Cessna 400 Area Navigation System (Type RN-478A) consists of an RN-478A Area NAV Computer (RNAV), a compatible VHF navigation receiver and course deviation indicator, and the Type R-476A distance measuring equipment (DME). The RNAV includes converter circuits which operate with the VHF navigation receiver and produce positional information for display by the course deviation indicator. It also includes computer circuits which combine the bearing information from the navigation set with the distance information from the R-476A DME to establish navigation data for selected waypoints. During RNAV operation, a course scalloping suppressor circuit suppresses the spurious navigation signal phases to provide stable waypoint information which enhances autopilot operation. The 400 RNAV is coupled to the number 2 Nav/Com and includes storage for 3 waypoints.

Ground speed/time-to-station information to the selected VOR (not the waypoint) is available on this system. This capability, along with the course scalloping suppression (radial straightening), may be used to an advantage while tracking inbound or outbound from the VOR station by programming a waypoint directly over the associated VOR (000.0°/000.0 nautical miles) and using RNAV for course smoothing while enroute.

CAUTION

If RNAV set is removed from the airplane or becomes inoperative, the associated VHF navigation indicator will be inoperative.

All operating controls and displays which are part of the RN-478A are shown and described in Figure 1. Other controls required for operation of the Cessna 400 Area Navigation System are included on the VHF navigation receiver and on the R-476A DME control; these controls are shown and described in the respective supplements included for this equipment.

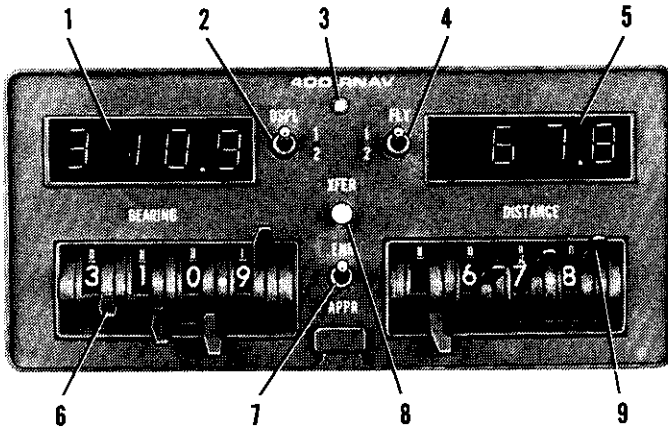

1. BEARING DISPLAY READOUT - Depending on position of DSPL Switch, displays bearing programmed for waypoint 1 or waypoint 2.
2. DISPLAY 1-2 SWITCH (DSPL) - Determines information shown on DISTANCE and BEARING displays: In position 1, distance and bearing programmed for waypoint 1 are displayed; in position 2, distance and bearing programmed for waypoint 2 are displayed.
3. FLY/DISPLAY LAMP - Flashes amber when FLY Switch and DSPL Switch are not set to same number; indicates that waypoint information being displayed is not waypoint information being flown.
4. FLY SWITCH - Determines waypoint being used for navigation. In position 1, waypoint 1 is in use; in position 2, waypoint 2 is in use.
5. DISTANCE DISPLAY READOUT - Depending on position of DSPL Switch, displays distance programmed for waypoint 1 or waypoint 2.
6. BEARING MINILEVER SWITCHES (4) - Select bearing of desired waypoint from VOR/DME station. May be used to store bearing of 3rd waypoint.
7. ENROUTE/APPROACH SWITCH (ENR/APPR) - Controls width of navigation corridor. ENR position provides standard (± 5 NM) enroute sensitivity; APPR position provides standard ($\pm 1-1/4$ NM) approach course sensitivity.

NOTE

Due to unreliable signals, do not operate in the APPR position when computed distance to waypoint exceeds 51 nautical miles.

8. TRANSFER PUSHBUTTON SWITCH (XFER) - Transfers waypoint distance and bearing from minilevers into either waypoint 1 or 2 as selected by DSPL switch position.
9. DISTANCE MINILEVER SWITCHES (4) - Select distance of desired waypoint from VOR/DME station. May be used to store distance of 3rd waypoint.

Figure 1. Cessna 400 Area Nav (Type RN-478A) Computer, Operating Controls and Indicators

SECTION 2 LIMITATIONS

The following RNAV IFR approach limitation must be adhered to during airplane operation.

OPERATING LIMITATION:

1. IFR Approaches -- Follow approved published RNAV instrument procedures.

SECTION 3 EMERGENCY PROCEDURES

There is no change to the airplane emergency procedures when this avionic equipment is installed.

SECTION 4 NORMAL PROCEDURES

VOR/LOC OPERATION

VOR NAVIGATION CIRCUITS VERIFICATION TESTS:

1. See appropriate Nav/Com supplement.

VOR/LOC NAVIGATION:

As a convenience to the pilot, a separate supplement (Avionic Operation Guide) is supplied to explain the various procedures for using the VHF Navigation Set for VOR and localizer navigation. Refer to the Avionic Operations Guide for flight procedures.

AREA NAVIGATION OPERATION

NOTE

Proper RNAV operation requires valid VOR and DME inputs to the RNAV system. In certain areas, the ground station antenna patterns and transmitter power may be inadequate to provide valid signals to the RNAV. For this

reason, intermittent RNAV signal loss may be experienced enroute. Prolonged loss of RNAV signal shall require the pilot to revert to other navigational procedures.

WAYPOINT PROGRAMMING:

1. Using a VFR sectional, enroute instrument chart, instrument approach plate, or enroute RNAV chart -- DETERMINE distance and bearing for desired waypoint(s) from appropriate VOR/DME stations.
2. VHF Navigation Receiver -- ON.
3. DME TEST/ON-OFF Switch -- ON.
4. DME Mode Selector Switch -- RNAV.
5. RNAV DSPL Switch -- 1.

NOTE

When DSPL and FLY switches are not set to the same waypoint number, the display/fly light slowly blinks on and off as a reminder to the pilot that values displayed are not those being used for navigation. This does not affect operation of the unit.

6. BEARING Minilever Switches -- SET to first waypoint bearing.
7. DISTANCE Minilever Switches -- SET to first waypoint distance.
8. XFER Pushbutton Switch -- PUSH in.
 - a. First waypoint bearing and distance are placed in memory as waypoint 1.
 - b. BEARING Display Readout -- DISPLAYS readout of first waypoint bearing.
 - c. DISTANCE Display Readout -- DISPLAYS readout of first waypoint distance.
9. RNAV DSPL Switch -- SET to 2.
10. BEARING Minilever Switches -- SET to second waypoint bearing.
11. DISTANCE Minilever Switches -- SET to second waypoint distance.
12. XFER Pushbutton Switch -- PUSH in.
 - a. Second Waypoint Readout -- BEARING and DISTANCE are placed in memory as waypoint 2.
 - b. BEARING Display Readout -- DISPLAYS readout of second waypoint bearing.
 - c. DISTANCE Display Readout -- DISPLAYS readout of second waypoint distance.
13. BEARING Minilever Switches -- SET to standby waypoint bearing.

14. DISTANCE Minilever Switches -- SET to standby waypoint distance.

NOTE

As first waypoint is reached, it can be replaced with the third "standby" waypoint (already set) before placing the RNAV "DSPL" switch to 2. Then a fourth waypoint, if necessary, can be set with the minilever selectors.

DISPLAY RELIABILITY TESTS:

NOTE

This test must be conducted following the "Waypoint Programming" procedures with the VHF Navigation Receiver and DME TEST/ON-OFF switches still in the ON position.

1. VHF Navigation Receiver Frequency Selector Switches -- SET to VOR frequency.
2. RNAV DSPL and FLY Switches -- DSPL set to 1, FLY set to 2.
 - a. Readout -- DISPLAYS first waypoint bearing and distance that was selected in Waypoint Programming.
 - b. Fly/Display Lamp (On RNAV Control Head) -- FLASHES.
3. RNAV DSPL and FLY Switches -- DSPL set to 2, FLY set to 1.
 - a. Readout -- DISPLAYS second waypoint bearing and distance.
 - b. Fly/Display Lamp (On RNAV Control Head) -- FLASHES.
4. RNAV DSPL and FLY Switches -- BOTH SET to same number.
 - a. Readout -- DISPLAYS waypoint bearing and distance as selected by DSPL switch.
 - b. Fly/Display Lamp (On RNAV Control Head) -- NOT LIGHTED.
5. DME Mode Selector Switch -- SET to RNAV.
 - a. Both RN and NM Annunciators on DME -- LIGHTED.
 - b. RN Lamp on Course Deviation Indicator -- LIGHTS.
6. VHF Navigation Receiver Frequency Selector Switches -- SET to LOC frequency.
 - a. Both RN and NM Annunciators -- LIGHTED.
 - b. RN Lamp on Course Deviation Indicator -- LIGHTED.
 - c. Course Deviation Indicator OFF(or NAV)/TO-FROM Indicator -- OFF (or NAV) flag in view.
7. DME Mode Selector Switch -- SET to NAV 1, NAV 2, or HOLD.
 - a. NM Annunciator on DME -- LIGHTED.
 - b. RN Annunciator on DME -- NOT LIGHTED.
 - c. RN Lamp on Course Deviation Indicator -- NOT LIGHTED.
 - d. Course Indicator OFF(or NAV)/TO-FROM Indicator -- Shows TO if a usable signal is received.

8. DME Mode Selector Switch -- RNAV.
9. DME TEST/ON-OFF Switch -- HOLD to TEST.
 - a. DME RN/NM Distance Display -- READOUT is 888.8.
 - b. DME KTS/MIN Ground Speed/Time-to-Station Display -- READOUT is 888.
 - c. RNAV BEARING Display -- READOUT is 888.8.
 - d. RNAV DISTANCE Display -- READOUT is 188.8.

AREA NAVIGATION CIRCUITS SELF-TEST:

1. VHF Navigation Receiver -- ON.
2. VHF Navigation Receiver Frequency Selector Switches -- SET to a usable VOR/DME frequency.
3. DME TEST/ON-OFF Switch -- ON.
4. DME Mode Selector Switch -- RNAV.
 - a. RN Lamp on Course Deviation Indicator -- LIGHTED.
5. RNAV Computer -- PROGRAMMED to waypoint.
6. DSPL and FLY Switches -- SET both to waypoint to be tested.
 - a. BEARING Display -- READOUT is waypoint bearing.
 - b. DISTANCE Display -- READOUT is waypoint distance.
 - c. Course Indicator -- RN LAMP lights.
7. Course Indicator OBS (or ARC) -- SET to waypoint bearing.
8. VHF Navigation Receiver ID/VOX/T Switch -- HOLD in T position.
 - a. Course Deviation Pointer -- CENTERS.
 - b. Course Deviation Indicator OFF(or NAV)/TO-FROM Flag -- Shows TO.
 - c. DME Distance Display -- READOUT is the same as the RNAV DISTANCE readout.

NOTE

After releasing the navigation receiver test (T) switch, the return to accurate computed bearing and distance data can take up to 60 seconds depending upon airplane position and waypoint.

SECTION 5 PERFORMANCE

There is no change to the airplane performance when this avionic equipment is installed. However, the installation of an externally mounted antenna or several related external antennas, will result in a minor reduction in cruise performance.

SUPPLEMENT

CESSNA 400 DME

(TYPE R-476A)

SECTION 1

GENERAL

The Cessna 400 DME (Type R-476A) is the airborne "interrogator" portion of a navigation system which supplies continuous, accurate, slant range distance information from a fixed ground station to an aircraft in flight.

Except for selection of the operating channel, which is selected by the VHF navigation receiver frequency selector switches, the Cessna 400 DME is capable of independent operation. The equipment consists of a panel-mounted C-476A Control Unit which contains all of the operating controls and displays, and a remotely mounted RTA-476A Receiver-Transmitter. The RTA-476A transmits interrogating pulse pairs on 200 channels between 1041 MHz and 1150 MHz; it receives associated ground-to-air replies between 978 MHz and 1213 MHz. The C-476A Control Unit digitally displays distances up to 200 nautical miles and either ground speed or time-to-station information, as selected. All operating controls and displays for the DME are shown in Figure 1, and the functions of each are described.

SECTION 2

LIMITATIONS

There is no change to the airplane limitations when this avionic equipment is installed.

SECTION 3

EMERGENCY PROCEDURES

There is no change to the airplane emergency procedures when this avionic equipment is installed.

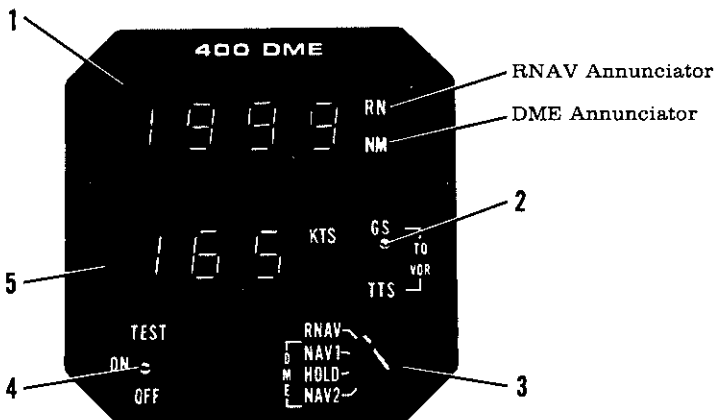

1. **DISTANCE DISPLAY** - In NAV 1, NAV 2, or HOLD mode, displays distance to selected VOR/DME station in nautical miles; only NM (Nautical Miles) annunciator lights. In RNAV mode, displays distance to selected waypoint in nautical miles; both RN (RNAV) and NM annunciators light.
2. **GS/TTS SELECTOR SWITCH** - In NAV 1, NAV 2, or HOLD mode, selects display of ground speed (GS) or time-to-station (TTS). In RNAV mode, display shows ground speed component to or from the VOR (not to waypoint) or the time to the VOR station at that indicated ground speed.
3. **DME MODE SELECTOR SWITCH** - Selects DME operating mode as follows:
 - RNAV:** Selects area navigation operation; selects display of nautical miles (distance) to selected RNAV waypoint.
 - NAV 1:** Selects DME operation with No. 1 VHF navigation set; enables channel selection by NAV 1 frequency selector switches.
 - HOLD:** Selects DME memory circuit; DME remains channeled to station to which it was channeled when HOLD was selected; display of distance continues to be nautical miles to that station. Both the NAV 1 and the NAV 2 sets may be set to new operation frequencies.

CAUTION

In the HOLD mode, there is no annunciation of the VOR/DME station frequency.

NAV 2: Selects DME operation with No. 2 VHF navigation set; enables channel selection by NAV 2 frequency selector switches.

Figure 1. Cessna 400 DME (Type R-476A) (Sheet 1 of 2)

4. TEST/ON-OFF SWITCH - Controls application of power to DME circuits (turns equipment on or off); selects display lamp test for DME and RNAV displays.
5. GROUND SPEED/TIME DISPLAY - Displays ground speed in knots or time-to-station in minutes, as follows:
 - a. With GS/TTS Switch set to GS, displays ground speed component to or from station in knots (aircraft must be flying directly to or from the VOR/DME station for true ground speed indication).
 - b. With GS/TTS Switch set to TTS, displays time to VOR/DME station in minutes at the ground speed component indicated.
 - c. With GS/TTS in RNAV mode will display ground speed component or time-to-station at that speed to the selected VOR (not the waypoint).

Figure 1. Cessna 400 DME (Type R-476A) (Sheet 2 of 2)

SECTION 4

NORMAL PROCEDURES

DME OPERATION:

1. TEST/ON-OFF Switch -- SET to ON.
2. DME Mode Selector Switch -- SET to NAV 1 or NAV 2.
3. NAV 1 and NAV 2 VHF Navigation Receivers -- ON; SET FREQUENCY selector switches to VOR/DME station frequencies, as required.

NOTE

When the VOR frequency is selected, the appropriate DME frequency is automatically channeled. Therefore, the system does not provide independent operation of the DME for reception of the DME Morse Code identifier.

4. DME SPEAKER/PHONE Selector Switch (on audio control panel) -- SET to desired mode.
5. GS/TTS Switch -- SET as desired.
6. TEST/ON-OFF Switch -- HOLD to TEST:
 - a. Distance-to-Station Display readout is 188.8.
 - b. Knots/Minutes Display readout is 888.
7. TEST/ON-OFF Switch -- RELEASE to ON; display readouts return to normal.

SECTION 5

PERFORMANCE

There is no change to the airplane performance when this avionics equipment is installed. However the installation of an externally mounted antenna or several related external antennas, will result in a minor reduction in cruise performance.

SUPPLEMENT

CESSNA 400 GLIDE SLOPE **(Type R-443B)**

SECTION 1

GENERAL

The Cessna 400 Glide Slope is an airborne navigation receiver which receives and interprets glide slope signals from a ground-based Instrument Landing System (ILS). It is used with the localizer function of a VHF navigation system when making instrument approaches to an airport. The glide slope provides vertical path guidance while the localizer provides horizontal track guidance.

The Cessna 400 Glide Slope system consists of a remote-mounted receiver coupled to an existing navigation system, a panel-mounted indicator and an externally mounted antenna. The glide slope receiver is designed to receive ILS glide slope signals on any of 40 channels. The channels are spaced 150 kHz apart and cover a frequency range of 329.15 MHz through 335.0 MHz. When a localizer frequency is selected on the NAV receiver, the associated glide slope frequency is selected automatically.

Operation of the Cessna 400 Glide Slope system is controlled by the associated navigation system. The functions and indications of typical 300 series glide slope indicators are pictured and described in Figure 1. The 300 series glide slope indicators shown in Figure 1 depict typical indications for Cessna-crafted glide slope indicators. However, refer to the 400 Nav/Com or HSI write-ups if they are listed in this section as options for additional glide slope indicators.

SECTION 2

LIMITATIONS

There is no change to the airplane limitations when this avionic equipment is installed.

TYPICAL 300 SERIES GLIDE SLOPE INDICATORS

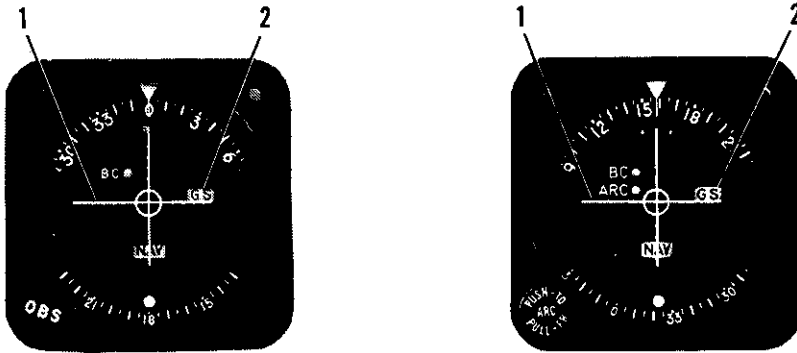

1. GLIDE SLOPE DEVIATION POINTER - Indicates deviation from normal glide slope.
2. GLIDE SLOPE "OFF" OR "GS" FLAG - When visible, indicates unreliable glide slope signal or improperly operating equipment. The flag disappears when a reliable glide slope signal is being received.

CAUTION

Spurious glide slope signals may exist in the area of the localizer back course approach which can cause the glide slope "OFF" or "GS" flag to disappear and present unreliable glide slope information. Disregard all glide slope signal indications when making a localizer back course approach unless a glide slope (ILS BC) is specified on the approach and landing chart.

Figure 1. Typical 300 Series VOR/LOC/ILS Indicator

SECTION 3 EMERGENCY PROCEDURES

There is no change to the airplane emergency procedures when this avionic equipment is installed.

SECTION 4 NORMAL PROCEDURES

TO RECEIVE GLIDE SLOPE SIGNALS:

NOTE

The pilot should be aware that on many Cessna airplanes equipped with the windshield mounted glide slope antenna, pilots should avoid use of 2700 \pm 100 RPM on airplanes equipped with a two-bladed propeller or 1800 \pm 100 RPM on airplanes equipped with a three-bladed propeller during ILS approaches to avoid oscillations of the glide slope deviation pointer caused by propeller interference.

1. NAV Frequency Select Knobs -- SELECT desired localizer frequency (glide slope frequency is automatically selected).
2. NAV/COM VOX-ID-T Switch -- SELECT ID position to disconnect filter from audio circuit.
3. NAV VOL Control -- ADJUST to desired listening level to confirm proper localizer station.

CAUTION

When glide slope "OFF" or "GS" flag is visible, glide slope indications are unusable.

SECTION 5 PERFORMANCE

There is no change to the airplane performance when this avionic equipment is installed.

SUPPLEMENT

CESSNA 400 MARKER BEACON (Type R-402A)

SECTION 1 GENERAL

The system consists of a remote mounted 75 MHz marker beacon receiver, an antenna which is either flush mounted or externally mounted on the under side of the aircraft and operating controls and annunciator lights which are mounted on the front of the audio control panel.

Operating controls for the marker beacon system are supplied on the front of the two types of audio control panels used in this Cessna aircraft. The operating controls for the marker beacon are different on the two audio control panels. One type of audio control panel is supplied with one or two transmitters and the other is supplied with three transmitters.

The marker beacon operating controls and annunciator lights used on the audio control panel supplied with two or less transmitters are shown and described in Figure 1. The operating controls consist of three, three-position toggle switches. One switch is labeled "HIGH/LO/MUTE" and provides the pilot with HIGH-LO sensitivity selection and marker beacon audio muting, for approximately 30 seconds, to enable voice communication to be heard without interference of marker beacon signals. The marker beacon audible tone is automatically restored at the end of the 30 second muting period to continue marker audio for passage over the next marker. Another switch is labeled "SPKR/OFF/PHN" and is used to turn the set on and select the desired speaker or phone position for marker beacon signals. The third toggle switch labeled, "ANN LT", is provided to enable the pilot to select the desired DAY or NITE lighting position for annunciator lights, and also a "TEST" position to verify operation of marker beacon annunciator lights.

The marker beacon operating controls and annunciator lights used on the audio control panel supplied with three transmitters are shown and described in Figure 2. The operating controls consist of two, three-position toggle switches, and two concentric control knobs. One switch is labeled "SPKR/PHN" and is used to select the desired speaker or phone position for marker beacon signals. The other switch is labeled "HI/LO/TEST" and

provides the pilot with HI-LO sensitivity selection and a TEST position to verify operation of all annunciator lights. The small, inner control knob labeled OFF/VOL, turns the set on or off and adjusts the audio listening level. The large, outer control knob labeled BRT, provides light dimming for the marker beacon lights.

When the Cessna 400 Marker Beacon controls are incorporated in an audio control panel incorporated with two or less transmitters a marker Beacon audio level adjustment potentiometer and an annunciator lights minimum dimming potentiometer are mounted on the audio control panel circuit board. Potentiometer adjustments cannot be accomplished externally. However, if readjustments are desired, adjustments can be made in accordance with instructions found in the Avionics Installations Service/Parts Manual for this aircraft.

MARKER FACILITIES

MARKER	IDENTIFYING TONE	LIGHT*
Inner & Fan	Continuous 6 dots/sec (3000 Hz)	White
Middle	Alternate dots and dashes (1300 Hz)	Amber
Outer	2 dashes/sec (400 Hz)	Blue

* When the identifying tone is keyed, the respective indicating light will blink accordingly.

PILOT'S OPERATING HANDBOOK CESSNA 400 MARKER BEACON
SUPPLEMENT (TYPE R-402A)

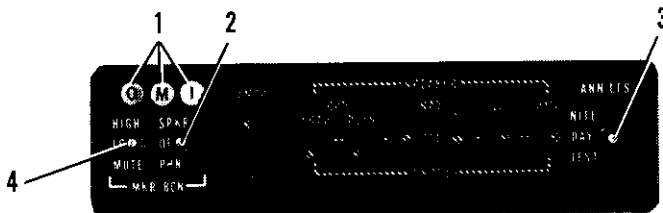

AUDIO CONTROL PANEL FOR USE WITH ONE OR TWO TRANSMITTERS

1. MARKER BEACON ANNUNCIATOR LIGHTS:

OUTER - Light illuminates blue to indicate passage of outer marker beacon.
MIDDLE - Light illuminates amber to indicate passage of middle marker beacon.
INNER and FAN - Light illuminates white to indicate passage of inner and fan marker beacon.

2. SPEAKER/OFF/PHONE SELECTOR SWITCH:

SPEAKER POSITION - Turns set on and selects speaker for aural reception.
OFF POSITION - Turns set off.
PHONE POSITION - Turns set on and selects phone for aural reception.

3. ANNUNCIATOR LIGHTS SWITCH:

NITE POSITION - Places the annunciator lights in a dim lighting mode for night flying operations. Light intensity of the NITE position is controlled by the RADIO LT dimming rheostat.
DAY POSITION - Places the annunciator lights in the full bright position for daylight flying operations.
TEST POSITION - Illuminates all marker beacon annunciator lights (and other annunciators) in the full bright position to verify operation of annunciator lights.

4. HIGH/LO/MUTE SELECTOR SWITCH:

HIGH POSITION - Receiver sensitivity is positioned for airway flying.
LO POSITION - Receiver sensitivity is positioned for ILS approaches.
MUTE POSITION - The marker beacon audio signals are temporarily blanked out (for approximately 30 seconds) and then automatically restored, over the speaker or headset in order to provide voice communications without interference of marker beacon signals.

Figure 1. Cessna 400 Marker Beacon Operating Controls and Indicator Lights Supplied with Two or Less Transmitters

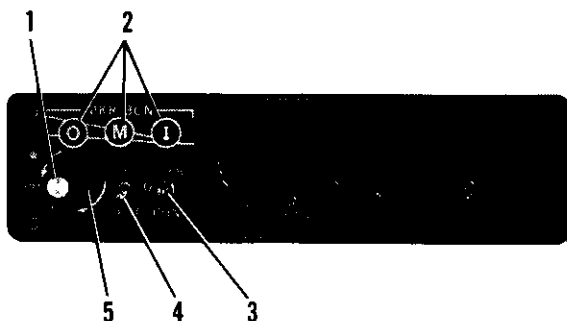

AUDIO CONTROL PANEL FOR USE WITH THREE TRANSMITTERS

1. OFF/VOLUME CONTROL:

OFF/VOL - Turns the set on or off and adjusts the audio listening level. Clockwise rotation of the smaller knob turns the set on and increases the audio level.

2. MARKER BEACON ANNUNCIATOR LIGHTS:

OUTER - Light illuminates blue to indicate passage of outer marker beacon.
MIDDLE - Light illuminates amber to indicate passage of middle marker beacon.
INNER and FAN - Light illuminates white to indicate passage of inner or fan marker beacon.

3. SPEAKER/PHONE SELECTOR SWITCH:

SPEAKER POSITION - Selects speaker for aural reception.
PHONE POSITION - Selects headphone for aural reception.

4. HI/LO/TEST SELECTOR SWITCH:

HI POSITION - Receiver sensitivity is positioned for airway flying.
LO POSITION - Receiver sensitivity is positioned for ILS approaches.
TEST POSITION - Illuminates all annunciator lights in the full bright position to verify operation of annunciator lights.

5. LIGHT DIMMING CONTROL:

BRT - Provides light dimming for the annunciator lights. Clockwise rotation of the larger knob increases light intensity.

Figure 2. Cessna 400 Marker Beacon Operating Controls and Indicator Lights Supplied With Three Transmitters.

SECTION 2 LIMITATIONS

There is no change to the airplane limitations when this avionic equipment is installed.

SECTION 3 EMERGENCY PROCEDURES

There is no change to the airplane emergency procedures when this avionic equipment is installed.

SECTION 4 NORMAL PROCEDURES

MARKER BEACON OPERATING PROCEDURES FOR USE WITH AUDIO CONTROL PANELS PROVIDED WITH ONE OR TWO TRANSMITTERS (REF. FIG. 1)

1. SPKR/OFF/PHN Selector Switch -- SELECT desired speaker or phone audio. Either selected position will turn set on.
2. NITE/DAY/TEST Selector Switch -- PRESS to TEST position and verify that all marker beacon annunciator lights illuminate full bright to indicate lights are operational.
3. NITE/DAY/TEST Selector Switch -- SELECT desired position for NITE or DAY lighting.
4. HIGH/LO/MUTE Selector Switch -- SELECT HI position for airway flying or LO position for ILS approaches.

NOTE

Press MUTE switch to provide an approximate 30 seconds temporary blanking out of Marker Beacon audio tone. The marker beacon audio tone identifier is automatically restored at the end of the muting period.

NOTE

Due to the short distance typical between the middle marker and inner marker, audio identification of the inner marker may not be possible if muting is activated over the middle marker.

MARKER BEACON OPERATING PROCEDURES FOR USE WITH
AUDIO CONTROL PANELS PROVIDED WITH THREE TRANSMIT-
TERS. (REF. FIG. 2)

1. OFF/VOL Control -- TURN to VOL position and adjust to desired listening level. Clockwise rotation increases audio level.
2. HI/LO Sen Switch -- SELECT HI position for airway flying or LO position for ILS approaches.
3. SPKR/PHN Switch -- SELECT speaker or phone audio.
4. BRT Control -- SELECT BRT (full clockwise). ADJUST as desired when illuminated over marker beacon.
5. TEST Switch -- PRESS to TEST position and verify that all marker beacon annunciator lights will illuminate full bright to indicate lights are operational.

SECTION 5

PERFORMANCE

There is no change to the airplane performance when this avionic equipment is installed. However, the installation of an externally mounted antenna or several related external antennas, will result in a minor reduction in cruise performance.

SUPPLEMENT

CESSNA 400 NAV/COM (720-Channel - Type RT-485A)

SECTION 1 GENERAL

The Cessna 400 Nav/Com (Type RT-485A), shown in Figure 1, consists of a panel-mounted receiver-transmitter and a single or dual-pointer remote 300 or 400 Series course deviation indicator.

The set includes a 720-channel VHF communications receiver-transmitter and a 200-channel VHF navigation receiver, both of which may be operated simultaneously. The communications receiver-transmitter receives and transmits signals between 118.000 and 135.975 MHz in 25-kHz steps. The navigation receiver receives omni and localizer signals between 108.00 and 117.95 MHz in 50 kHz steps. The circuits required to interpret the omni and localizer signals are located in the course deviation indicator. Microprocessor frequency management provides storage for 3 preset NAV and 3 preset COM frequencies in MEMORY. A "keep-alive" voltage prevents loss of the preset frequencies when the Nav/Com is turned off. Both the communications and navigation operating frequencies are digitally displayed by incandescent readouts on the front panel of the Nav/Com.

A DME receiver-transmitter or a glide slope receiver, or both, may be interconnected with the Nav/Com set for automatic selection of the associated DME or glide slope frequency. When a VOR frequency is selected on the Nav/Com, the associated VORTAC or VOR-DME station frequency will also be selected automatically; likewise, if a localizer frequency is selected, the associated glide slope frequency will be selected automatically.

The 400 Nav/Com may be installed with either 300 or 400 Series course deviation indicators. The 400 Series Nav/Com indicators incorporate Automatic Radial Centering and a Course Datum synchro as standard features. The 300 Series course deviation indicators do not incorporate Course Datum synchro but are offered with, or without, Automatic Radial Centering.

NOTE

An autopilot option utilizing Course Datum is not available on this aircraft.

Both the 300 and 400 Series course deviation indicators include either a single-pointer and related NAV flag for VOR/LOC indication only, or dual pointers and related NAV and GS flags for both VOR/LOC and glide slope indications. Both types of indicators incorporate a back-course lamp (BC) which lights when back course (reversed sense) operation is selected. Indicators with Automatic Radial Centering will, when selected, automatically indicate the bearing TO or FROM the VOR station.

The Cessna 400 Nav/Com incorporates a variable threshold automatic squelch. With this squelch system, you set the threshold level for automatic operation - the further clockwise the lower the threshold - or the more sensitive the set. When the signal is above this level, it is heard even if the noise is very close to the signal. Below this level, the squelch is fully automatic so when the background noise is very low, very weak signals (that are above the noise) are let through. For normal operation of the squelch circuit, just turn the squelch clockwise until noise is heard - then back off slightly until it is quiet, and you will have automatic squelch with the lowest practical threshold. This adjustment should be rechecked periodically during each flight to assure optimum reception.

All controls for the Nav/Com, except the omni bearing selector (OBS) knob or automatic radial centering (ARC) knob, which is located on the course deviation indicator, are mounted on the front panel of the receiver-transmitter. The audio control panels used in conjunction with this radio are shown and described in another supplement in this section.

SECTION 2

LIMITATIONS

There is no change to the airplane limitations when this avionic equipment is installed.

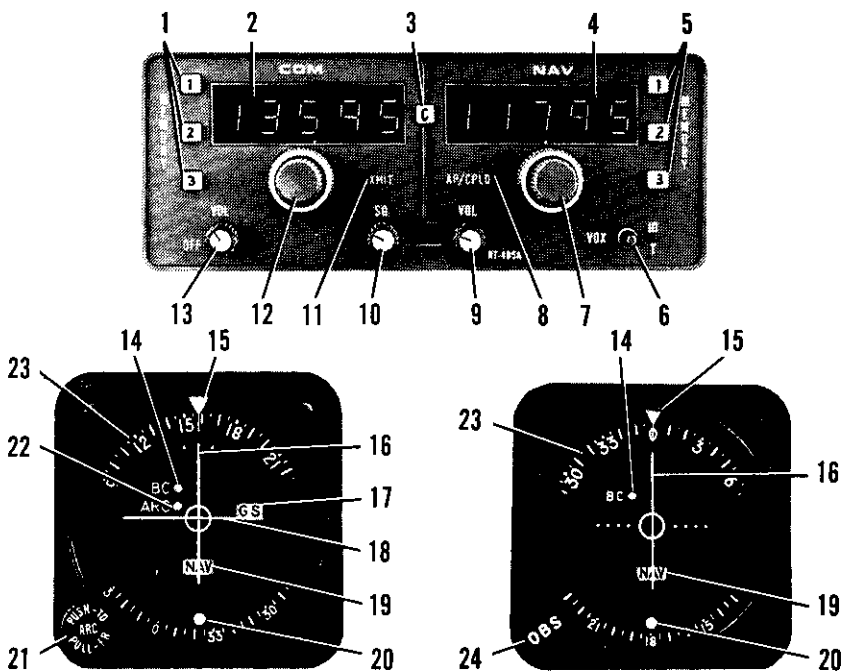

TYPICAL 300 SERIES INDICATORS

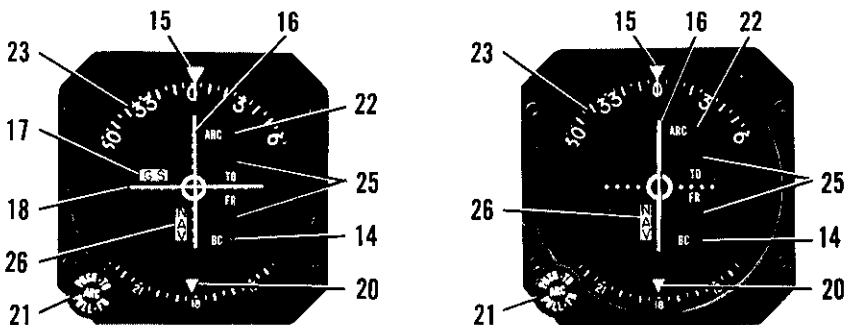

TYPICAL 400 SERIES INDICATORS

Figure 1. Cessna 400 Nav/Com (Type RT-485A), Operating Controls and Indicators (Sheet 1 of 4)

1. COM MEMORY 1, 2 & 3 PUSHBUTTONS - When a COM MEMORY pushbutton is pressed, the preset selected frequency will appear in the COM frequency window for use as the selected operating frequency. Each pushbutton will illuminate white when pressed and the light will go out on the previously selected pushbutton. Three preset frequencies may be stored in MEMORY and selected as desired, by merely pressing the appropriate COM MEMORY pushbutton to recall the desired operating frequency. If electrical power to the set's "keep-alive" circuit has not been interrupted, upon turn-on, the set will automatically recall the last COM MEMORY frequency selected by the MEMORY pushbutton. If electrical power is removed from the set's "keep-alive" circuit (such as radio removal or battery replacement) for more than 15 seconds, upon turn-on, the COM MEMORY circuits will have to be reset and COM 1 MEMORY will automatically be selected with the lowest operating frequency (118.000 MHz) selected.
2. COMMUNICATION OPERATING FREQUENCY READOUT - Indicates COM frequency in use. Third decimal place not shown.
3. CYCLE BUTTON (C) - Selects last illuminated decimal place on COM frequency in use. If last decimal place is 2 or 7, pressing C pushbutton changes number to 5 or 0, respectively. If last decimal place is 5 or 0, pressing C pushbutton changes number to 7 or 2, respectively. When the last illuminated digit on the set is 2 or 7, the third digit on the set (not shown) will always be 5. When the last illuminated digit on the set is 0 or 5, the third digit on the set (not shown) will always be 0. Also provides test function by holding C pushbutton pressed for more than 1.7 seconds. This lights each COM and NAV MEMORY pushbutton in turn, and displays the corresponding preset frequency in MEMORY.
4. NAVIGATION OPERATING FREQUENCY READOUT - Indicates NAV frequency in use.
5. NAV MEMORY 1, 2 & 3 PUSHBUTTONS - When a NAV MEMORY pushbutton is pressed, the preset selected frequency will appear in the NAV frequency window for use as the selected operating frequency. Each pushbutton will illuminate white when pressed and the light will go out on the previously selected pushbutton. Three preset frequencies may be stored in MEMORY and selected as desired, by merely pressing the appropriate NAV MEMORY pushbutton to recall the desired operating frequency. If electrical power to the set's "keep-alive" circuit has not been interrupted, upon turn-on, the set will automatically recall the last NAV MEMORY frequency selected by the MEMORY pushbutton. If electrical power is removed from the set's "keep-alive" circuit (such as radio removal or battery replacement) for more than 15 seconds, upon turn-on, the NAV MEMORY circuits will have to be reset and NAV 1 MEMORY will automatically be selected with the lowest operating frequency (108.000 MHz) selected.
6. ID-VOX-T SWITCH - In ID position, station identifier signal is audible; in VOX (Voice) position, identifier signal is suppressed; in T (Momentary On) position, the self-test function is selected, and the AP/CPLD annunciator illuminates amber and the XMIT annunciator illuminates green.
7. NAVIGATION RECEIVER FREQUENCY SELECTORS - Outer knob changes NAV frequency in 1-MHz steps between 108 and 117 MHz; inner knob changes NAV frequency in .05-MHz steps between .00 and .95 MHz; simultaneously selects paired glide slope frequency and DME channel.

Figure 1. Cessna 400 Nav/Com (Type RT-485A), Operating Controls and Indicators (Sheet 2 of 4)

8. AUTOPILOT COUPLED ANNUNCIATOR (AP/CPLD) - Illuminates amber when a 400B or 400B IFCS autopilot is coupled to NAV VOR/LOC converter output (non-operational with 200A, 300A, 400, 400A and 400A IFCS autopilots).
9. NAV VOLUME CONTROL (VOL) - Adjusts volume of navigation receiver audio.
10. SQUELCH CONTROL - Used to adjust signal threshold necessary to activate COM receiver audio. Clockwise rotation increases background noise (decreases squelch action); counterclockwise rotation decreases background noise.
11. TRANSMIT ANNUNCIATOR (XMIT) - Illuminates green when transmitter output is normal while mike is keyed.
12. COMMUNICATION RECEIVER FREQUENCY SELECTORS - Outer knob changes COM frequency in 1-MHz steps between 118 and 135 MHz; inner knob changes COM frequency in .05 MHz steps between .025 and .975 MHz or between .000 and .950 MHz depending on selection of C button.
13. COM OFF-VOLUME CONTROL (OFF-VOL) - Combination ON/OFF switch and volume control; turns on Nav/Com set and controls volume of COM receiver audio.
14. BACK-COURSE LAMP (BC) - Amber light illuminates when an autopilot's back-course function is engaged and receiver is tuned to a localizer frequency; indicates course deviation pointer is reversed. BC light dimming is only available when installed with an audio control panel incorporating the annunciator lights DAY/NITE selector switch.
15. COURSE INDEX - Indicates selected VOR COURSE.
16. COURSE DEVIATION POINTER - Indicates course deviation from selected omni course or localizer centerline.
17. GLIDE SLOPE "GS" FLAG - When visible, red GS flag indicates unreliable glide slope signal or improperly operating equipment. Flag disappears when a reliable glide slope signal is being received.
18. GLIDE SLOPE DEVIATION POINTER - Indicates deviation from ILS glide slope.
19. NAV/TO-FROM INDICATOR - Operates only with a VOR or localizer signal. Red NAV position (Flag) indicates unusable signal. With usable VOR signal, indicates whether selected VOR course is TO or FROM station. With usable localizer signal, TO flag is in view.
20. RECIPROCAL COURSE INDEX - Indicates reciprocal of selected VOR course.
21. AUTOMATIC RADIAL CENTERING (ARC) PUSH-TO/PULL-FR SELECTOR - In center detent, functions as conventional OBS. Pushed to inner (Momentary On) position, rotates OBS course card to center course deviation pointer with a TO flag, then returns to conventional OBS selection. Pulled to outer detent, continuously drives OBS course card to indicate bearing from VOR station, keeping

Figure 1. Cessna 400 Nav/Com (Type RT-485A), Operating Controls and Indicators (Sheet 3 of 4)

course deviation pointer centered, with a FROM flag. ARC function will not operate on localizer frequencies.

NOTE

Engaging either Automatic Radial Centering (ARC) functions will alter the airplane's course anytime the autopilot is engaged and coupled to any frequency other than a localizer frequency.

22. AUTOMATIC RADIAL CENTERING (ARC) LAMP - Amber light illuminates when Automatic Radial Centering is in use. ARC light dimming is only available when installed with an audio control panel incorporating the annunciator lights DAY/NITE selector switch.
23. COURSE CARD - Indicates selected VOR course under course index.
24. OMNI BEARING SELECTOR (OBS) - Rotates course card to select desired VOR radial.
25. TO/FROM INDICATOR (TO/FR) - Operates only with a usable VOR or localizer signal. When white flag is in view, indicates whether selected course is TO or FROM station. With usable localizer signal, TO flag is in view.
26. NAV INDICATOR FLAG - When in view, red NAV position (Flag) indicates the selected VOR or localizer signal is unusable.

Figure 1. Cessna 400 Nav/Com (Type RT-485A), Operating Controls and Indicators (Sheet 4 of 4)

SECTION 3

EMERGENCY PROCEDURES

There is no change to the airplane emergency procedures when this avionics equipment is installed. However, if the frequency readouts fail, the frequency controls should not be moved due to the difficulty of obtaining a known frequency under this condition. The radio will remain operational on the last frequency selected, and the preset frequencies in MEMORY may be selected by pressing the appropriate MEMORY pushbutton.

SECTION 4

NORMAL PROCEDURES

PRESETTING NAV/COM FREQUENCIES IN MEMORY:

1. COM OFF/VOL CONTROL -- TURN ON; adjust to desired audio level.
2. MEMORY 1 Pushbutton -- PRESS desired NAV or COM pushbutton 1 momentarily to alert the memory bank of a forthcoming frequency to be stored.
3. FREQUENCY SELECTORS -- MANUALLY ROTATE corresponding NAV or COM frequency selectors (press C pushbutton as required to select the desired third fractional COM digit) until the desired frequency is shown in the operating frequency readout window. The frequency displayed will be automatically transferred into MEMORY 1.

NOTE

Do not press the C pushbutton more than about 2 seconds while selecting fractional frequencies or you will activate the MEMORY test function.

4. MEMORY 2 and 3 Pushbuttons -- REPEAT STEPS 2 and 3 using next desired NAV or COM MEMORY to be stored. Up to 3 NAV and 3 COM frequencies may be stored for automatic recall frequency selection.

NOTE

The operating frequency set in the selected MEMORY position will automatically be changed in the MEMORY bank any time the operating frequency is manually changed.

COMMUNICATION RECEIVER-TRANSMITTER OPERATION:

1. COM OFF/VOL Control -- TURN ON.
2. XMTR SEL Switch (on audio control panel) -- SET to desired 400 Nav/Com.
3. SPEAKER/PHONE Selector Switches (on audio control panel) -- SET to desired mode.
4. COM Frequency Selection -- SELECT desired operating frequency by either pressing a COM MEMORY 1, 2 or 3 pushbutton to recall a preset frequency, or by manually selecting the desired operating frequency using the COM frequency selectors and C pushbutton.

5. VOL Control -- ADJUST to desired audio level.
6. SQ Control -- ROTATE counterclockwise to just eliminate background noise.
7. Mike Button:
 - a. To Transmit -- DEPRESS and SPEAK into microphone.

NOTE

Sidetone may be selected by placing the AUTO selector switch (on audio control panel) in either the SPEAKER or PHONE position, or may be eliminated by placing the AUTO selector switch in the OFF position. Adjustment of sidetone on audio control panels supplied with three transmitters cannot be accomplished externally. However, audio control panels supplied with one or two transmitters have sidetone adjustment pots that are accessible through the front of the audio control panel with a small screwdriver.

- b. XMIT Annunciator Light -- CHECK ON (green light illuminated).
- c. To Receive -- RELEASE mike button.

NAVIGATION OPERATION:

NOTE

The pilot should be aware that on many Cessna airplanes equipped with the windshield mounted glide slope antenna, pilots should avoid use of 2700 \pm 100RPM on airplanes equipped with a two-bladed propeller or 1800 \pm 100 RPM on airplanes equipped with a three-bladed propeller during ILS approaches to avoid oscillations of the glide slope deviation pointer caused by propeller interference.

1. COM OFF/VOL Control -- TURN ON; adjust to desired audio level.
2. SPEAKER/PHONE Selector Switches (on audio control panel) -- SET to desired mode.
3. NAV Frequency Selection -- SELECT desired operating frequency by either pressing a NAV MEMORY 1, 2 or 3 pushbutton to recall a preset frequency, or by using NAV frequency selectors.
4. NAV VOL Control -- ADJUST to desired audio level.
5. ID-VOX-T Switch:
 - a. To Identify Station -- SET to ID to hear navigation station identifier signal.
 - b. To Filter Out Station Identifier Signal -- SET to VOX to include filter in audio circuit.

6. ARC PUSH-TO/PULL-FROM Knob (If Applicable):
 - a. To Use As Conventional OBS -- PLACE in center detent and select desired course.
 - b. To Obtain Bearing TO VOR Station -- PUSH (ARC/PUSH-TO) knob to inner (Momentary On) position.

NOTE

ARC lamp will illuminate amber while the course card is moving to center the course deviation pointer. After alignment has been achieved to reflect bearing TO VOR, automatic radial centering will automatically shut down, causing the ARC lamp to go out and the ARC knob to return to the center detent position and function as a normal OBS.

- c. To obtain Continuous Bearing FROM VOR Station -- PULL (ARC/PULL-FR) knob to outer detent.

NOTE

ARC lamp will illuminate amber, OBS course card will turn to center the course deviation pointer with a FROM flag to indicate bearing from VOR station. This system will continually drive to present the VOR radial the aircraft is on until manually returned to the center detent by the pilot.

VOR SELF-TEST OPERATION:

1. COM OFF/VOL Control -- TURN ON.
2. NAV Frequency Selector Switches -- SELECT usable VOR station signal.
3. OBS Knob -- SET for 0° course at course index; course deviation pointer centers or deflects left or right, depending on bearing of signal; NAV/TO-FROM indicator shows TO or FROM.
4. ID/VOX/T Switch -- PRESS to T and HOLD at T; course deviation pointer centers, NAV/TO-FROM indicator shows FROM and AP/CPLD and XMIT annunciators light.
5. OBS Knob -- TURN to displace course approximately 10° to either side of 0° (while holding ID/VOX/T to T). Course deviation pointer deflects full scale in direction corresponding to course displacement. NAV/TO-FROM indicator shows FROM.

NOTE

When the 400 NAV/COM is coupled to the ANS-351C

RNAV system the TEST operation is non-functional. Refer to the "Ground Check Procedures" in the Area Navigation System (Type ANS-351C) Supplement in this section to verify VOR operation of the CDI.

6. ID/VOX/T Switch -- RELEASE for normal operation.

NOTE

This test does not fulfill the requirements of FAR 91.25.

MEMORY TEST OPERATION:

1. C Pushbutton -- PUSH for about 2 seconds. Each COM and NAV MEMORY pushbutton (1, 2 & 3) will illuminate white, in turn, with the corresponding preset frequency displayed.

NOTE

If the "keep-alive" circuit has not been interrupted, the MEMORY test will always start with the last COM MEMORY selected and cycle through the remaining COM and NAV preset frequencies. The MEMORY test will always stop on the last selected COM and NAV preset frequencies.

SECTION 5 PERFORMANCE

There is no change to the airplane performance when this avionic equipment is installed. However, the installation of an externally mounted antenna or several related external antennas, will result in a minor reduction in cruise performance.

SUPPLEMENT

CESSNA 400 NAV/COM (Type RT-485A)

WITH

CESSNA 400 AREA NAVIGATION SYSTEM (Type RN-478A)

SECTION 1 **GENERAL**

The Cessna 400 Nav/Com (Type RT-485A) Set with Cessna 400 Area Navigation (RNAV-Type RN-478A) consists of a RT-485A Nav/Com, a R-476A DME system, a RN-478A Area Navigation Computer and a Course Deviation Indicator, with or without, the optional Automatic Radial Centering (ARC) feature. The RN-478A includes circuits which combine the VOR navigation information with distance information from the R-476A DME system to provide data for area navigation. Operating information for the communication set and for VOR/localizer navigation is presented in this supplement. Operating information for area navigation and for DME is presented in separate supplements. Microprocessor frequency management provides storage for 3 preset NAV and 3 preset COM frequencies in MEMORY. A "keep-alive" voltage prevents loss of the preset frequencies when the NAV/COM Switch, Avionics Power Switch, or Master Switch is turned OFF.

The RT-485A Receiver-Transmitter includes a 720-channel VHF communication receiver-transmitter which receives and transmits signals between 118.000 MHz and 135.975 MHz in 25-kHz steps. It also includes a 200-channel VHF navigation receiver which receives VOR and localizer signals between 108.00 MHz and 117.95 MHz in 50-kHz steps. The communication receiver-transmitter and the navigation receiver can be operated simultaneously.

The VOR or localizer signal from the No. 2 Navigation Receiver is

applied to the converter circuits in the RN-478A Area Navigation Computer. The converter processes the received navigation signal to provide omni bearing or localizer information for display by the course indicator.

CAUTION

If the RNAV set is removed from the airplane or becomes inoperative, the associated VHF navigation indicator will be inoperative.

The course indicator includes a Course Deviation Indicator (CDI), an Omni Bearing Selector (OBS) or Automatic Radial Centering (ARC) knob, and OFF (or NAV)/To-From Indicator Flags. It also includes an RNAV lamp (RN) which lights when area navigation operation is selected, and a back-course lamp (BC) which lights when back-course operation is selected. The IN-442AR is offered as the standard Course Deviation Indicator and an optional IN-1048AC Course Deviation Indicator is also offered when Automatic Radial Centering (ARC) is desired. When the optional IN-1048AC Course Deviation Indicator is installed, an Automatic Radial Centering lamp (ARC) is incorporated in the CDI to alert the pilot that the Automatic Radial Centering feature has been selected.

All operating controls and indicators for the Cessna 300 Nav/Com are included on the front panel of the RT-385A Receiver-Transmitter and the associated Course Deviation Indicator. These controls and indicators are shown and described in Figure 1. Operating controls for the RN-478A Area Navigation Computer, which are used for area navigation, and operating controls for the associated Type R-476A DME are shown in the appropriate supplements in this manual. Operating controls for the audio control panels used in conjunction with this radio are shown and described in another supplement in this section.

SECTION 2 LIMITATIONS

There is no change to the airplane limitations when this avionic equipment is installed.

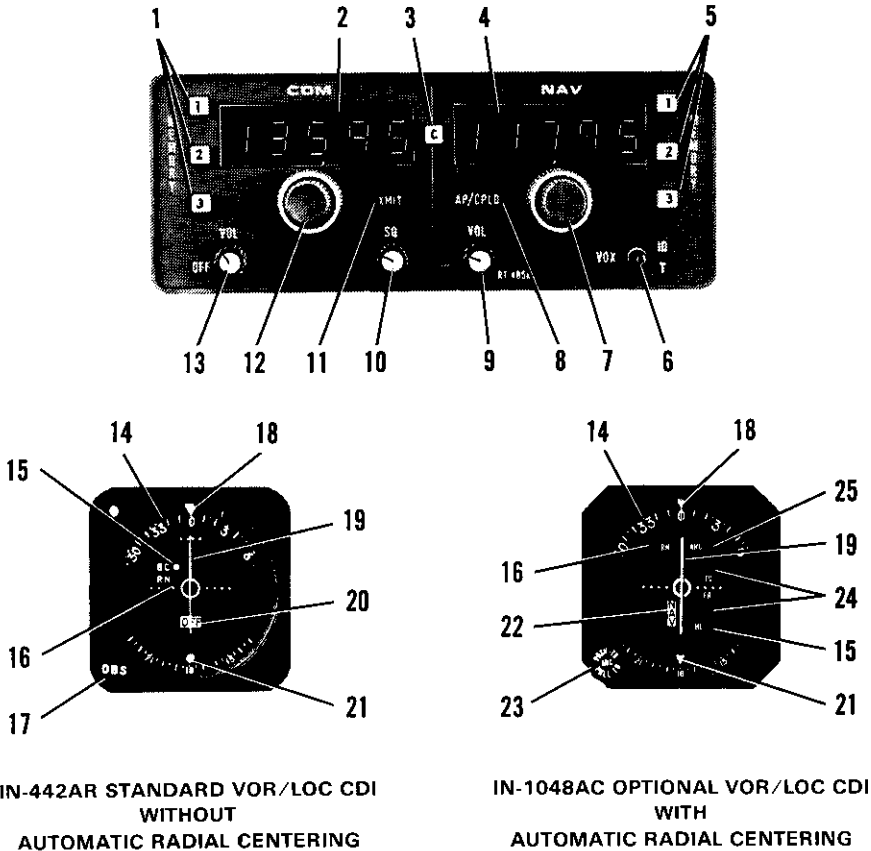

1. **COMM MEMORY 1, 2 & 3 PUSHBUTTONS** - When a COM MEMORY pushbutton is pressed, the preset selected frequency will appear in the COM frequency window for use as the selected operating frequency. Each pushbutton will illuminate white when pressed and the light will go out on the previously selected pushbutton. Three preset frequencies may be stored in MEMORY and selected as desired, by merely pressing the appropriate COM MEMORY pushbutton to recall the desired operating frequency. If electrical power to the set's "keep-alive" circuit has not been interrupted, upon turn-on, the set will automatically recall the last COM MEMORY frequency selected by the MEMORY pushbutton. If electrical power is removed from the set's "keep-alive" circuit (such as radio removal or battery replacement) for more than 15 seconds, upon turn-on, the COM MEMORY circuits will have to be reset and COM 1 MEMORY will automatically be selected with the lowest operating frequency (118.000 MHz) selected.

Figure 1. Cessna 400 Nav/Com Set, Operating Controls and Indicators
(Sheet 1 of 4)

2. COMMUNICATION OPERATING FREQUENCY READOUT - Indicates COM frequency in use. Third decimal place not shown.
3. CYCLE BUTTON (C) - Selects last illuminated decimal place on COM frequency in use. If last decimal place is 2 or 7, pressing C pushbutton changes number to 5 or 0, respectively. If last decimal place is 5 or 0, pressing C pushbutton changes number to 7 or 2, respectively. When the last illuminated digit on the set is 2 or 7, the third digit on the set (not shown) will always be 5. When the last illuminated digit on the set is 0 or 5, the third digit on the set (not shown) will always be 0. Also provides test function by holding C pushbutton pressed for more than 1.7 seconds. This lights each COM and NAV MEMORY pushbutton in turn, and displays the corresponding preset frequency in MEMORY.
4. NAVIGATION OPERATING FREQUENCY READOUT - Indicates NAV frequency in use.
5. NAV MEMORY 1, 2 & 3 PUSHBUTTONS - When a NAV MEMORY pushbutton is pressed, the preset selected frequency will appear in the NAV frequency window for use as the selected operating frequency. Each pushbutton will illuminate white when pressed and the light will go out on the previously selected pushbutton. Three preset frequencies may be stored in MEMORY and selected as desired, by merely pressing the appropriate NAV MEMORY pushbutton to recall the desired operating frequency. If electrical power to the set's "keep-alive" circuit has not been interrupted, upon turn-on, the set will automatically recall the last NAV MEMORY frequency selected by the MEMORY pushbutton. If electrical power is removed from the set's "keep-alive" circuit (such as radio removal or battery replacement) for more than 15 seconds, upon turn-on, the NAV MEMORY circuits will have to be reset and NAV 1 MEMORY will automatically be selected with the lowest operating frequency (108.000 MHz) selected.
6. ID-VOX-T SWITCH - In ID position, station identifier signal is audible; in VOX (Voice) position, identifier signal is suppressed; in T (Momentary On) position, the self-test function is selected, and the AP/CPLD annunciator illuminates amber and the XMIT annunciator illuminates green.
7. NAVIGATION RECEIVER FREQUENCY SELECTORS - Outer knob changes NAV frequency in 1-MHz steps between 108 and 117 MHz; inner knob changes NAV frequency in .05-MHz steps between .00 and .95 MHz; simultaneously selects paired glide slope frequency and DME channel.
8. AUTOPILOT COUPLED ANNUNCIATOR (AP/CPLD) - Non-operational with 200A, 300A and 400 autopilots.
9. NAV VOLUME CONTROL (VOL) - Adjusts volume of navigation receiver audio.
10. SQUELCH CONTROL - Used to adjust signal threshold necessary to activate COM receiver audio. Clockwise rotation increases background noise (decreases squelch action); counterclockwise rotation decreases background noise
11. TRANSMIT ANNUNCIATOR (XMIT) - Illuminates green when transmitter output is normal while mike is keyed.

Figure 1. Cessna 400 Nav/Com Set, Operating Controls and Indicators
(Sheet 2 of 4)

12. COMMUNICATION RECEIVER FREQUENCY SELECTORS - Outer knob changes COM frequency in 1-MHz steps between 118 and 135 MHz; inner knob changes COM frequency in .05 MHz steps between .025 and .975 MHz or between .000 and .950 MHz depending on setting of C button.
13. COM OFF-VOLUME CONTROL (OFF-VOL) - Combination ON/OFF switch and volume control; turns on Nav/Com set and controls volume of COM receiver audio.
14. COURSE CARD - Indicates selected VOR course under course index.
15. BACK-COURSE LAMP (BC) - Amber light illuminates when an autopilot's back-course function is engaged and receiver is tuned to a localizer frequency; indicates course deviation pointer is reversed. Light dimming is only available when installed with an audio control panel incorporating the annunciator lights DAY/NITE selector switch.
16. AREA NAV LAMP (RN) - When green light is illuminated, indicates that RNAV operation is selected. Light dimming is only available when installed with an audio control panel incorporating the annunciator lights DAY/NITE selector switch.
17. OMNI BEARING SELECTOR (OBS) - Rotates course card (12) to select desired bearing to or from a VOR station or to a selected RNAV waypoint.
18. COURSE INDEX - Indicates selected VOR or RNAV course (bearing).
19. COURSE DEVIATION POINTER - Indicates course deviation from selected VOR or RNAV course or localizer centerline.
20. OFF/TO-FROM INDICATOR - Operates only with VOR, localizer or RNAV signal. OFF position (flag) indicates unusable signal. With usable VOR signal, when OFF position disappears, indicates whether selected course is TO or FROM station or waypoint. With usable localizer signal, TO flag is in view.
21. RECIPROCAL COURSE INDEX - Indicates reciprocal of selected VOR or RNAV course.
22. NAV INDICATOR FLAG - When in view, red NAV position (Flag) indicates the selected VOR or localizer signal is unusable.
23. AUTOMATIC RADIAL CENTERING (ARC - PUSH-TO/PULL-FR) SELECTOR - In center detent, functions as conventional OBS. Pushed to inner (Momentary On) position, turns OBS course card (14) to center course deviation pointer (19) with a TO flag (24), then returns to conventional OBS selection. Pulled to outer detent, continuously drives OBS course card (14) to indicate bearing from VOR station, keeping course deviation pointer (19) centered, with a FROM flag (24). ARC function will not operate on localizer frequencies.

Figure 1. Cessna 400 Nav/Com Set, Operating Controls and Indicators
(Sheet 3 of 4)

NOTE

Engaging either Automatic Radial Centering (ARC) functions will alter the airplane's course anytime the autopilot is engaged and coupled to any frequency other than a localizer frequency.

24. INDICATOR (TO/FR) - Operates only with a usable VOR, localizer or RNAV signal. When white flag is in view, indicates whether selected course is TO or FROM station. With usable localizer signal, TO flag is in view.
25. AUTOMATIC RADIAL CENTERING (ARC) LAMP - Amber light illuminates when Automatic Radial Centering is in use. Light dimming is only available when installed with an audio control panel incorporating the annunciator lights DAY/NITE selector switch.

Figure 1. Cessna 400 Nav/Com Set, Operating Controls and Indicators
(Sheet 4 of 4)

SECTION 3

EMERGENCY PROCEDURES

There is no change to the airplane emergency procedures when this avionic equipment is installed. However, if the frequency readouts fail, the frequency controls should not be moved due to the difficulty of obtaining a known frequency under this condition. The radio will remain operational on the last frequency selected, and the preset frequencies in MEMORY may be selected by pressing the appropriate MEMORY pushbutton.

SECTION 4

NORMAL PROCEDURES

PRESETTING NAV/COM FREQUENCIES IN MEMORY:

1. COM OFF/VOL CONTROL -- TURN ON; adjust to desired audio level.
2. MEMORY 1 Pushbutton -- PRESS desired NAV or COM pushbutton 1 momentarily to alert the memory bank of a forthcoming frequency to be stored.
3. FREQUENCY SELECTORS -- MANUALLY ROTATE corresponding NAV or COM frequency selectors (press C pushbutton as required to select the desired third fractional COM digit) until the desired frequency is shown in the operating frequency readout window. The frequency displayed will be automatically transferred into MEMORY 1.

NOTE

Do not press the C pushbutton more than about 2 seconds while selecting fractional frequencies or you will activate the MEMORY test function.

4. MEMORY 2 and 3 Pushbutton -- REPEAT STEPS 2 and 3 using next desired NAV or COM MEMORY to be stored. Up to 3 NAV and 3 COM frequencies may be stored for automatic recall frequency selection.

NOTE

The operating frequency set in the selected MEMORY position will automatically be changed in the memory bank anytime the operating frequency is manually changed.

COMMUNICATIONS OPERATION:

1. COM OFF/VOL Control -- TURN ON.
2. XMTR SEL Switch (on audio control panel) -- SET to No. 2 400 Nav/Com.
3. SPEAKER/PHONE Selector Switches (on audio control panel) -- SET to desired mode.
4. COM Frequency Selection -- SELECT desired operating frequency by either pressing a COM MEMORY 1, 2 or 3 pushbutton to recall a preset frequency, or by manually selecting the desired operating frequency using the COM frequency selectors and C pushbutton.
5. VOL Control -- ADJUST to desired audio level.
6. SQ Control -- ROTATE counterclockwise to just eliminate background noise.
7. Mike Button:
 - a. To Transmit -- DEPRESS and SPEAK into microphone.

NOTE

Sidetone may be selected by placing the AUTO selector switch (on audio control panel) in either the SPEAKER or PHONE position, or may be eliminated by placing the AUTO selector switch in the OFF position. Adjustment of sidetone on audio control panels supplied with three transmitters cannot be accomplished externally. However, audio control panels supplied with two or less transmitters have sidetone adjustment pots that are accessible through the front of the audio control panel with a small screwdriver.

- b. XMIT Annunciator Light -- CHECK ON (green light illuminated).
- c. To Receive -- RELEASE mike button.

NAVIGATION OPERATION:

NOTE

The pilot should be aware that on many Cessna airplanes equipped with the windshield mounted glide slope antenna, pilots should avoid use of 2700 \pm 100 RPM on airplanes equipped with a two-bladed propeller or 1800 \pm 100 RPM on airplanes equipped with a three-bladed propeller during ILS approaches to avoid oscillations of the glide slope deviation pointer caused by propeller interference.

1. COM OFF/VOL Control -- TURN ON; adjust to desired audio level.
2. SPEAKER/PHONE Selector Switches (on audio control panel) -- SET to desired mode.

3. NAV Frequency Selection -- SELECT desired operating frequency by either pressing a NAV MEMORY 1, 2 or 3 pushbutton to recall a preset frequency, or by using NAV frequency selectors.
4. NAV VOL Control -- ADJUST to desired audio level.
5. ID-VOX-T Switch:
 - a. To Identify Station -- SET to ID to hear navigation station identifier signal.
 - b. To Filter Out Station Identifier Signal -- SET to VOX to include filter in audio circuit.
6. ARC PUSH-TO/PULL-FROM Knob (If Applicable):
 - a. To Use As Conventional OBS -- PLACE in center detent and select desired course.
 - b. To Obtain Bearing TO VOR Station -- PUSH knob to inner (Momentary On) position.

NOTE

ARC lamp will illuminate amber while the course card is moving to center the course deviation pointer. After alignment has been achieved to reflect bearing TO VOR, automatic radial centering will automatically shut down, causing the ARC lamp to go out and the ARC knob to return to center detent position and function as a normal OBS.

- c. To obtain Continuous Bearing FROM VOR Station -- PULL (ARC/PULL-FR) knob to outer detent.

NOTE

ARC lamp will illuminate amber, OBS course card will turn to center the course deviation pointer with a FROM flag to indicate bearing from VOR station. This system will continually drive to present the VOR radial the aircraft is on until manually returned to the center detent by the pilot.

VOR SELF-TEST OPERATION:

1. COM OFF/VOL Control -- TURN ON.
2. NAV Frequency Selector Switches -- SELECT usable VOR station signal.
3. OBS Knob -- SET for 0° course at course index; course deviation pointer centers or deflects left or right, depending on bearing of signal; NAV/TO-FROM indicator shows TO or FROM.

4. ID/VOX/T Switch -- PRESS to T and HOLD at T; course deviation pointer centers, NAV/TO-FROM indicator shows FROM and AP/CPLD and XMIT annunciators light.
5. OBS Knob -- TURN to displace course approximately 10° to either side of 0° (while holding ID/VOX/T to T). Course deviation pointer deflects full scale in direction corresponding to course displacement. NAV/TO-FROM indicator shows FROM.
6. ID/VOX/T Switch -- RELEASE for normal operation.

NOTE

This test does not fulfill the requirements of FAR 91.25.

MEMORY TEST OPERATION:

1. C Pushbutton -- PUSH for about 2 seconds. Each COM and NAV MEMORY pushbutton (1, 2 & 3) will illuminate white, in turn, with the corresponding preset frequency displayed.

NOTE

If the "keep-alive" circuit has not been interrupted, the MEMORY test will always start with the last COM MEMORY selected and cycle through the remaining COM and NAV preset frequencies. The MEMORY test will always stop on the last selected COM and NAV preset frequencies.

SECTION 5 PERFORMANCE

There is no change to the airplane performance when this avionic equipment is installed. However, the installation of an externally mounted antenna or several related external antennas, will result in a minor reduction in cruise performance.

SUPPLEMENT

CESSNA 400 TRANSPONDER

(Type RT-459A)

AND

OPTIONAL ALTITUDE ENCODER

(BLIND)

SECTION 1

GENERAL

The Cessna 400 Transponder (Type RT-459A), shown in Figure 1, is the airborne component of an Air Traffic Control Radar Beacon System (ATCRBS). The transponder enables the ATC ground controller to "see" and identify the aircraft, while in flight, on the control center's radarscope more readily.

The Cessna 400 Transponder system consists of a panel-mounted unit, an externally-mounted antenna and an optional control wheel-mounted XPDR IDENT switch. The transponder receives interrogating pulse signals on 1030 MHz and transmits pulse-train reply signals on 1090 MHz. The transponder is capable of replying to Mode A (aircraft identification) and also to Mode C (altitude reporting) when coupled to an optional altitude encoder system. The transponder is capable of replying on both modes of interrogation on a selective reply basis on any of 4096 information code selections. The optional altitude encoder system (not part of a standard 400 Transponder system) required for Mode C (altitude reporting) operation consists of a completely independent remote-mounted digitizer that is connected to the static system and supplies encoded altitude information to the transponder. When the altitude encoder system is coupled to the 300 Transponder system, altitude reporting capabilities are available in 100-foot increments between -1000 and the airplane's maximum service ceiling.

All Cessna 400 Transponder operating controls, with the exception of the optional XPDR IDENT switch, are located on the front panel of the unit. The remote XPDR IDENT switch is located on the right hand grip of the pilot's control wheel. Functions of the operating controls are described in Figure 1.

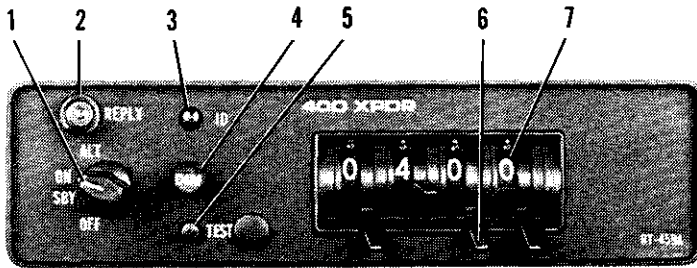

1. FUNCTION SWITCH - Controls application of power and selects transponder operating mode as follows:

OFF - Turns set off.

SBY - Turns set on for equipment warm-up or standby power.

ON - Turns set on and enables transponder to transmit Mode A (aircraft identification) reply pulses.

ALT - Turns set on and enables transponder to transmit either Mode A (aircraft identification) reply pulses or Mode C (altitude reporting) pulses selected automatically by the interrogating signal.

Figure 1. Cessna 400 Transponder and Altitude Encoder (Blind)
(Sheet 1 of 2)

PILOT'S OPERATING HANDBOOK CESSNA 400 TRANSPONDER
SUPPLEMENT AND ALTITUDE ENCODER (BLIND)

2. REPLY LAMP - Lamp flashes to indicate transmission of reply pulses; glows steadily to indicate transmission of IDENT pulse or satisfactory self-test operation. (Reply lamp will also glow steadily during initial warm-up period.)
3. IDENT (ID) SWITCH - When depressed, selects special pulse identifier to be transmitted with transponder reply to effect immediate identification of aircraft on ground controller's display. (Reply lamp will glow steadily during duration of IDENT pulse transmission.)
4. DIMMER (DIM) CONTROL - Allows pilot to control brilliance of reply lamp.
5. SELF-TEST (TEST) SWITCH - When depressed, causes transponder to generate a self-interrogating signal to provide a check of transponder operation. (Reply lamp will glow steadily to verify self-test operation.)
6. REPLY-CODE SELECTOR SWITCHES (4) - Select assigned Mode A reply code.
7. REPLY-CODE INDICATORS (4) - Display selected Mode A reply code.
8. REMOTE-MOUNTED DIGITIZER - Provides an altitude reporting code range of -1000 feet up to the airplane's maximum service ceiling.
9. REMOTE ID SWITCH (XPDR IDENT) - Same as panel-mounted ID switch described in Item 3.

Figure 1. Cessna 400 Transponder and Altitude Encoder (Blind)
(Sheet 2 of 2)

SECTION 2

LIMITATIONS

There is no change to the airplane limitations when this avionic equipment is installed. However, the following information must be displayed in the form of a placard located near the altimeter.

ALTITUDE ENCODER EQUIPPED

SECTION 3

EMERGENCY PROCEDURES

TO TRANSMIT AN EMERGENCY SIGNAL:

1. Function Switch -- ON.
2. Reply-Code Selector Switches -- SELECT 7700 operating code.

TO TRANSMIT A SIGNAL REPRESENTING LOSS OF ALL COMMUNICATIONS (WHEN IN A CONTROLLED ENVIRONMENT):

1. Function Switch -- ON.
2. Reply-Code Selector Switches -- SELECT 7700 operating code for 1 minute; then SELECT 7600 operating code for 15 minutes and then REPEAT this procedure at same intervals for remainder of flight.

SECTION 4

NORMAL PROCEDURES

BEFORE TAKEOFF:

1. Function Switch -- SBY.

TO TRANSMIT MODE A (AIRCRAFT IDENTIFICATION) CODES IN FLIGHT:

1. Reply-Code Selector Switches -- SELECT assigned code.
2. Function Switch -- ON.

3. DIM Control -- ADJUST light brilliance of reply lamp.

NOTE

During normal operation with function switch in ON position, reply lamp flashes indicating transponder replies to interrogations.

4. ID or XPDR IDENT Button -- DEPRESS momentarily when instructed by ground controller to "squawk IDENT" (reply lamp will glow steadily, indicating IDENT operation).

TO TRANSMIT MODE C (ALTITUDE REPORTING) CODES IN FLIGHT:

1. Reply-Code Selector Switches -- SELECT assigned code.
2. Function Switch -- ALT.

NOTE

When directed by ground controller to "stop altitude squawk", turn Function Switch to ON for Mode A operation only.

NOTE

Pressure altitude is transmitted by the transponder for altitude squawk and conversion to indicated altitude is done in ATC computers. Altitude squawked will only agree with indicated altitude when the local altimeter setting in use by the ground controller is set in the aircraft altimeter.

3. DIM Control -- ADJUST light brilliance of reply lamp.

TO SELF-TEST TRANSPONDER OPERATION:

1. Function Switch -- SBY and wait 30 seconds for equipment to warm-up.
2. Function Switch -- ON.
3. TEST Button -- DEPRESS (reply lamp should light brightly regardless of DIM control setting).
4. TEST Button -- RELEASE for normal operation.

SECTION 5

PERFORMANCE

There is no change to the airplane performance when this avionic equipment is installed. However, the installation of an externally mounted antenna or several related external antennas, will result in a minor reduction in cruise performance.

SUPPLEMENT

CESSNA 400 TRANSPONDER **(Type RT-459A)**

AND

OPTIONAL ENCODING ALTIMETER **(Type EA-401A)**

SECTION 1

GENERAL

The Cessna 400 Transponder (Type RT-459A), shown in Figure 1, is the airborne component of an Air Traffic Control Radar Beacon System (ATCRBS). The transponder enables the ATC ground controller to "see" and identify the aircraft, while in flight, on the control center's radarscope more readily.

The Cessna 400 Transponder system consists of a panel-mounted unit, an externally-mounted antenna and an optional control wheel-mounted XPDR IDENT switch. The transponder receives interrogating pulse signals on 1030 MHz and transmits coded pulse-train reply signals on 1090 MHz. It is capable of replying to Mode A (aircraft identification) and also to Mode C (altitude reporting) interrogations on a selective reply basis on any of 4096 information code selections. When an optional panel mounted EA-401A Encoding Altimeter (not part of 400 Transponder System) is included in the avionics configuration, the transponder can provide altitude reporting in 100-foot increments between -1000 and +35,000 feet.

All Cessna 400 Transponder operating controls, with the exception of the optional altitude encoder's altimeter setting knob and the optional remote XPDR IDENT switch, are located on the front panel of the unit. The altimeter setting knob is located on the encoding altimeter and the remote XPDR IDENT switch is located on the right hand grip of the pilot's control wheel. Functions of the operating controls are described in Figure 1.

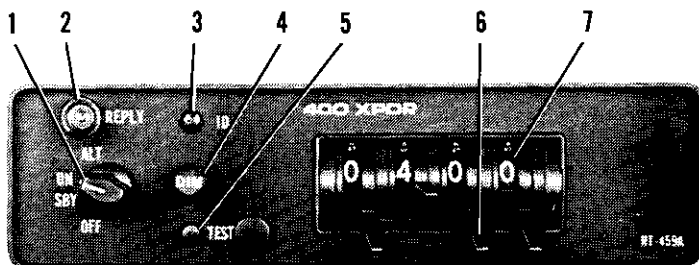

1. **FUNCTION SWITCH** - Controls application of power and selects transponder operating mode as follows:

OFF - Turns set off.

SBY - Turns set on for equipment warm-up or stand-by power.

ON - Turns set on and enables transponder to transmit Mode A (aircraft identification) reply pulses.

ALT - Turns set on and enables transponder to transmit either Mode A (aircraft identification) reply pulses or Mode C (altitude reporting) pulses selected automatically by the interrogating signal.

Figure 1. Cessna 400 Transponder and Encoding Altimeter
Operating Controls (Sheet 1 of 2)

2. **REPLY LAMP** - Lamp flashes to indicate transmission of reply pulses; glows steadily to indicate transmission of IDENT pulse or satisfactory self-test operation. (Reply lamp will also glow steadily during initial warm-up period.)
3. **IDENT (ID) SWITCH** - When depressed, selects special pulse identifier to be transmitted with transponder reply to effect immediate identification of aircraft on ground controller's display. (Reply lamp will glow steadily during duration of IDENT pulse transmission.)
4. **DIMMER (DIM) CONTROL** - Allows pilot to control brilliance of reply lamp.
5. **SELF-TEST (TEST) SWITCH** - When depressed, causes transponder to generate a self-interrogating signal to provide a check of transponder operation. (Reply lamp will glow steadily to verify self-test operation.)
6. **REPLY-CODE SELECTOR SWITCHES (4)** - Select assigned Mode A reply code.
7. **REPLY-CODE INDICATORS (4)** - Display selected Mode A reply code.
8. **1000-FOOT DRUM TYPE INDICATOR** - Provides digital altitude readout in 1000-foot increments between -1000 feet and +35,000 feet. When altitude is below 10,000 feet, a diagonally striped flag appears in the 10,000-foot window.
9. **OFF INDICATOR WARNING FLAG** - Flag appears across altitude readout when power is removed from the altimeter to indicate that readout is not reliable.
10. **100-FOOT DRUM TYPE INDICATOR** - Provides digital altitude readout in 100-foot increments between 0 and 1000 feet.
11. **20-FOOT INDICATOR NEEDLE** - Indicates altitude in 20-foot increments between 0 feet and 1000 feet.
12. **ALTIMETER SETTING SCALE - DRUM TYPE** - Indicates selected altimeter setting in the range of 27.9 to 31.0 inches of mercury on the standard altimeter or 950 to 1050 millibars on the optional altimeter.
13. **ALTIMETER SETTING KNOB** - Dials in desired altimeter setting in the range of 27.9 to 31.0 inches of mercury on the standard altimeter or 950 to 1050 millibars on the optional altimeter.
14. **REMOTE ID SWITCH (XPDR IDENT)** - Same as panel-mounted ID switch described in Item 3.

Figure 1. Cessna 400 Transponder and Encoding Altimeter
Operating Controls (Sheet 2 of 2)

SECTION 2

LIMITATIONS

There is no change to the airplane limitations when this avionic equipment is installed. However, the encoding altimeter used in this installation does have a limitation that requires a standard barometric altimeter be installed as a back-up altimeter.

SECTION 3

EMERGENCY PROCEDURES

TO TRANSMIT AN EMERGENCY SIGNAL:

1. Function Switch -- ON.
2. Reply-Code Selector Switches -- SELECT 7700 operating code.

TO TRANSMIT A SIGNAL REPRESENTING LOSS OF ALL COMMUNICATIONS (WHEN IN A CONTROLLED ENVIRONMENT):

1. Function Switch -- ON.
2. Reply-Code Selector Switches -- SELECT 7700 operating code for 1 minute; then SELECT 7600 operating code for 15 minutes and then REPEAT this procedure at same intervals for remainder of flight.

SECTION 4

NORMAL PROCEDURES

BEFORE TAKEOFF:

1. Function Switch -- SBY.

TO TRANSMIT MODE A (AIRCRAFT IDENTIFICATION) CODES IN FLIGHT:

1. Reply-Code Selector Switches -- SELECT assigned code.

2. Function Switch -- ON.
3. DIM Control -- ADJUST light brilliance of reply lamp.

NOTE

During normal operation with function switch in ON position, REPLY lamp flashes indicating transponder replies to interrogations.

4. ID or XPDR IDENT Button -- DEPRESS momentarily when instructed by ground controller to "squawk IDENT" (REPLY lamp will glow steadily, indicating IDENT operation).

TO TRANSMIT MODE C (ALTITUDE REPORTING) CODES IN FLIGHT:

1. Off Indicator Warning Flag -- VERIFY that flag is out of view on encoding altimeter.
2. Altitude Encoder Altimeter Setting Knob -- SET IN assigned local altimeter setting.
3. Reply-Code Selector Switches -- SELECT assigned code.
4. Function Switch -- ALT.

NOTE

When directed by ground controller to "stop altitude squawk", turn Function Switch to ON for Mode A operation only.

NOTE

Pressure altitude is transmitted by the transponder for altitude squawk and conversion to indicated altitude is done in ATC computers. Altitude squawked will only agree with indicated altitude when the local altimeter setting in use by the ground controller is set in the encoding altimeter.

5. DIM Control -- ADJUST light brilliance of reply lamp.

TO SELF-TEST TRANSPONDER OPERATION:

1. Function Switch -- SBY and wait 30 seconds for equipment to warm-up.
2. Function Switch -- ON or ALT.

3. TEST Button -- DEPRESS and HOLD (reply lamp should light with full brilliance regardless of DIM control setting).
4. TEST Button -- RELEASE for normal operation.

SECTION 5 PERFORMANCE

There is no change to the airplane performance when this avionic equipment is installed. However, the installation of an externally mounted antenna or several related external antennas, will result in a minor reduction in cruise performance.

SUPPLEMENT

CESSNA 400B NAVOMATIC AUTOPILOT (Type AF-550A)

SECTION 1 GENERAL

Cessna 400B Navomatic Autopilot (Type AF-550A) is a two axis automatic flight control system that governs the positions of the ailerons and elevators to provide automatic roll and pitch stability as commanded by the selected mode of operation. The system also provides for tracking of any magnetic heading, automatic intercept and tracking of VOR radials or ILS localizer and glide slope beams, and includes automatic pitch synchronization and trim, manual turn and pitch command, altitude hold, back course switching, Nav 1 or Nav 2 receiver selection, an automatic autopilot disengage acceleration sensor with an associated autopilot disengagement warning horn and a prior-to-flight test function.

The major components in a standard 400B autopilot system consist of a control unit and accessory unit mounted side-by-side in the lower center stack of the instrument panel, a panel-mounted vacuum driven unslaved directional gyro and an attitude gyro, a remote mounted autopilot computer, a remote mounted acceleration sensor with a built in "G" switch, an associated autopilot disengage warning horn, an altitude sensor, an aileron, elevator and elevator trim actuator. With this autopilot installation a fixed resistance is added to the flap motor circuitry to slow flap operation and thereby reduce the autopilot's pitch trim workload during flap deflections. A heavy duty aircraft battery is also installed as standard equipment with this autopilot system. In addition, an optional unslaved HSI is offered as replacement for the standard unslaved directional gyro and two optional slaved compass systems consisting of a remote mounted flux detector, a slaving accessory unit and either a slaved directional gyro or a slaved Horizontal Situation Indicator (HSI) are offered. Both the optional slaved DG and optional slaved HSI are panel-mounted and incorporate a slaving meter that monitors heading displacement error between the flux detector and the slaved DG or slaved HSI. The HSI, in addition to replacing the standard DG, also replaces the standard Course

Deviation Indicator (CDI) normally installed with the No. 1 navigational receiver.

NOTE

Since the No. 2 CDI is a 300 Series Indicator without a course datum syncro, Course Datum is not available with this installation.

The control unit (flight controller) and accessory unit contain most of the operating controls for the autopilot. An AP NAV 1/NAV 2 switch in the autopilot accessory unit provides for selection of the desired VOR receiver (NAV 1 or NAV 2) and a REV SNS selector switch (LOC 1 or LOC 2), also in the autopilot accessory unit, is provided to select back-course (reverse sensing) operation on the desired navigation receiver. In addition, there are two spring-loaded, slide-type toggle switches and a red pushbutton-type switch mounted on the pilot's control wheel. The two slide-type toggle switches on the pilot's control wheel provide for manual electric trim operation when the autopilot is OFF. The red AP/TRIM DISC pushbutton-type switch provides for autopilot and electric trim disconnect. All operating controls necessary to properly operate the 400B autopilot are shown and described in Figure 1.

An automatic autopilot disengage function (provided by the "G" switch in the acceleration sensor) will automatically disengage the autopilot anytime the airplane pitches down at more than a normal rate from normal flight attitude. The operational capability of the disengage function should be tested before takeoff by pressing the TEST EA FLT button, located on the accessory unit. When the TEST button is pressed with the autopilot engaged, the "G" switch in the acceleration sensor is actuated and if the "G" switch is functional, the autopilot will disengage, the autopilot disconnect horn will sound, and the autopilot disconnect (DISC) warning (WARN) light will illuminate yellow to advise the pilot the autopilot disengage system is operational.

The autopilot will also be automatically disengaged anytime the airplane pitches up 20° or down 18° on the attitude gyro. In this event, the disconnect horn will sound and the disconnect light will illuminate, advising the pilot that the autopilot has disengaged.

Two additional autopilot disengage features are provided. The first is a thermostatic switch which monitors the operating temperature of the aileron and elevator actuators. If the temperature becomes abnormal in either the roll or pitch actuator, the thermostatic switch opens and disengages the autopilot to remove power from the actuator. After approximately 10 minutes, the switch automatically resets to close the autopilot interlock circuit. Power can then be reapplied to the actuator by re-

engaging the AP/ON-OFF switch. The second is a "pull-off" type circuit breaker labeled A/P ACT, which when pulled out will disconnect all electrical power to the autopilot aileron and elevator actuators.

The autopilot disconnect (DISC) warning (WARN) light, on the accessory unit, will illuminate yellow when the autopilot is disengaged by any means other than the control wheel AP/TRIM DISC pushbutton. Whenever the autopilot is disengaged by any means, the autopilot disengage horn will produce a short tone lasting 1 to 2 seconds with decreasing amplitude. The autopilot disconnect warning (WARN) light (yellow) will remain on, until it is cancelled by pressing the control wheel AP/TRIM DISC pushbutton.

The back course (REV SNS LOC 1/LOC 2) selector switch, mounted in the autopilot accessory unit, is only used when conducting localizer approaches. With the navigation receiver set to a localizer frequency, positioning the switch to LOC 1 or LOC 2 (back course) will reverse the appropriate signals to provide for back course operation for either autopilot or manual flight. Except when a horizontal situation indicator is installed, selecting back course (REV SNS LOC 1/LOC 2) causes reversal of the Course Deviation Indicator (CDI) indication, whether or not the autopilot is being used.

The navigation receiver selector switch (AP NAV 1/NAV 2), installed in the autopilot accessory unit when dual navigation receivers are installed, allows the autopilot to operate in conjunction with either navigation receiver.

SECTION 2 LIMITATIONS

The following autopilot limitations must be followed during airplane operation.

1. Autopilot must be OFF for takeoff and landing.

OPERATING LIMITATIONS WITH AUTOPILOT ENGAGED:

1. Maximum Airspeed -- 157 KIAS.
2. Maximum Altitude Loss During Malfunction Recovery:
Cruise -- 580 Ft.
Approach -- 150 Ft.
3. Maximum Right Wing Heavy Fuel Unbalance With Autopilot Engaged -- 90 Lbs.

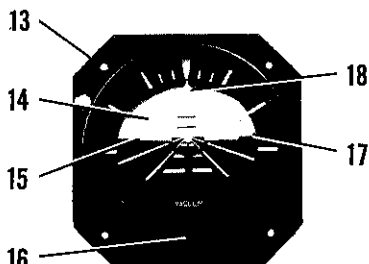
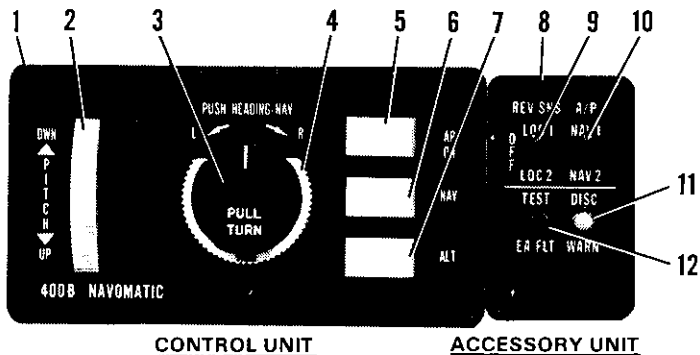

G-519A-1 HORIZON GYRO

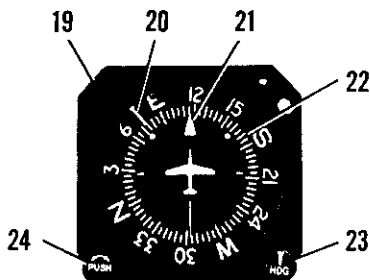

G-502A NON- SLAVED DG

STANDARD NON- SLAVED GYRO SYSTEM

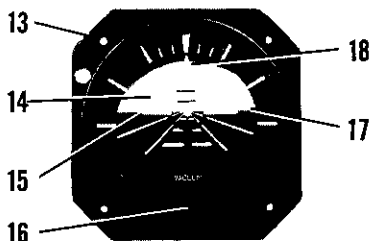

G-519A-1 HORIZON GYRO

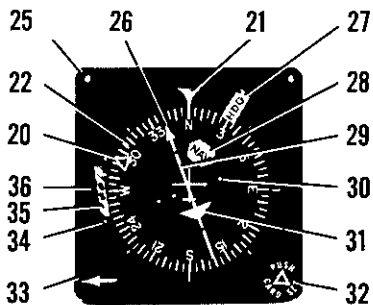

IG-832C NON-SLAVED HSI

OPTIONAL NON-SLAVED GYRO SYSTEM

Figure 1. Cessna 400B Navomatic Autopilot (Type AF-550A)
(Sheet 1 of 6)

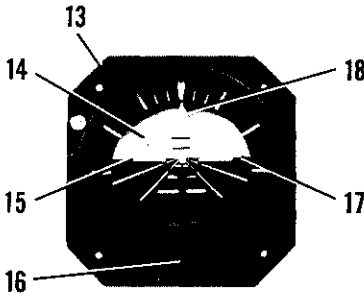

G-519A-1 HORIZON GYRO

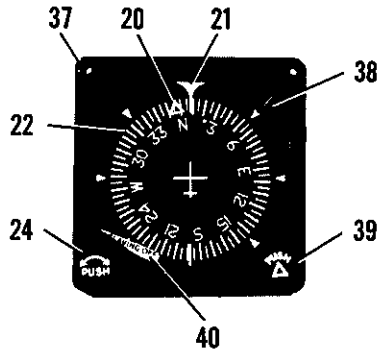

G-504A SLAVED DG

OPTIONAL SLAVED GYRO SYSTEM

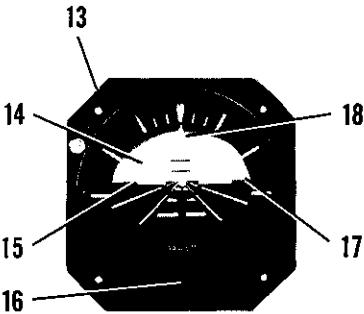

G-519A-1 HORIZON GYRO

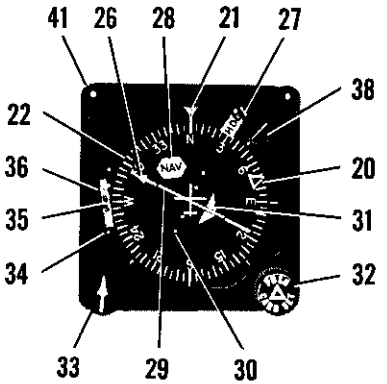

IG-832A SLAVED HSI

OPTIONAL SLAVED GYRO SYSTEM



CONTROL WHEEL SWITCHES

Figure 1. Cessna 400B Navomatic Autopilot (Type AF-550A)
(Sheet 2 of 6)

1. CONTROL UNIT - Provides the primary switches and controls for operating the autopilot.
2. PITCH COMMAND WHEEL - Controls pitch attitude of airplane. When rotated toward UP, airplane will pitch up. When rotated toward DWN, airplane will pitch down. Pitch attitude depends on displacement of control from level flight position.
3. PULL-TURN CONTROL KNOB - When pulled out and turned, aircraft will bank right (R) or left (L). When in detent and pushed in intercepts and maintains selected heading (HDG). When pulled out and in detent, acts as wing leveler.
4. LATERAL TRIM CONTROL (TRIM) - When PULL-TURN knob is pulled out and centered, control is used to trim aircraft for wings level attitude.
5. AUTOPILOT ON-OFF SWITCH (AP/ON) - Controls primary power to turn on or off the Navomatic 400B. When the AP/ON switch is turned off, the autopilot disengage horn will produce a short tone lasting from 1 to 2 seconds with decreasing amplitude and autopilot disconnect light will illuminate.
6. NAVIGATION ENGAGE SWITCH (NAV) - When PULL-TURN knob is pushed in, selects automatic VOR radial or localizer intercept and tracking operation.
7. ALTITUDE HOLD ENGAGE SWITCH (ALT) - Selects automatic altitude hold. If aircraft is in anything but level flight, the altitude control will smoothly level the airplane and return it to the altitude existing when ALT hold switch was pressed.
8. ACCESSORY UNIT - Provides the pilot with an automatic autopilot disconnect warning light, an autopilot disconnect system self-test button for use prior to flight, a reverse sense (back-course) selector switch and a navigation receiver selector switch.
9. BACK COURSE REVERSE SENSE (REV SNS) LOC 1 OR LOC 2 SELECTOR SWITCH - Used with LOC operation only. With AP switch OFF or ON, and when navigation receiver selected by AP switch (on autopilot accessory unit) is set to a localizer frequency, it reverses normal localizer needle indication on a course deviation indicator (CDI) and causes localizer reversed (BC) light to illuminate. With AP switch ON (on autopilot flight controller), reverses localizer signal to autopilot.

CAUTION

When an optional horizontal situation indicator (HSI) is installed, the omni deviation bar does not reverse. However, with AP switch ON (on autopilot control unit), selection of either LOC 1 or LOC 2 will always cause the localizer signal to the autopilot to reverse for back-course operation.

10. AUTOPILOT (AP) NAV 1 OR NAV 2 SELECTOR SWITCH - Selects appropriate signals from the desired navigation receiver.

Figure 1. Cessna 400B Navomatic Autopilot (Type AF-550A)
(Sheet 3 of 6)

11. AUTOPILOT DISCONNECT WARNING INDICATOR LIGHT (DISC WARN) - Whenever the autopilot is disengaged by any means, other than the control wheel AP/TRIM DISC pushbutton, the autopilot disconnect (DISC) warning (WARN) light will illuminate yellow and will remain lighted until it is cancelled by pressing the AP/TRIM DISC pushbutton. When the autopilot disconnect DISC WARN indicator light is activated, the circuit will also automatically activate an autopilot disengage warning horn that will produce a short tone lasting from 1 to 2 seconds with decreasing amplitude.
12. AUTOPILOT DISCONNECT TEST BUTTON (TEST EA FLT) - When the TEST EA FLT pushbutton is pressed and held with the autopilot engaged, the "G" switch in the acceleration sensor is actuated and if the "G" switch is functional, the AP/ON-OFF switch will automatically disengage, the autopilot disconnect horn will produce a short tone and the yellow autopilot disconnect warning light will illuminate to advise the pilot the "G" switch disengaging function is operational.
13. ATTITUDE GYRO - Provides the pilot with a visual indication of the airplane's pitch and roll attitude with respect to the earth and also provides the autopilot with electrical roll and pitch signals.
14. GYRO HORIZON (ATTITUDE BACKGROUND) - Moves with respect to symbolic aircraft to display actual pitch and roll attitude.
15. SYMBOLIC AIRCRAFT - Serves as a stationary symbol of the aircraft. Aircraft pitch and roll attitudes are displayed by the relationship between the fixed symbolic aircraft and the movable background.
16. SYMBOLIC AIRCRAFT ALIGNMENT KNOB - Provides manual positioning of the symbolic aircraft for level flight under various load conditions.
17. HORIZON LINE - Provides identification of artificial horizon.
18. ROLL ATTITUDE INDEX - Displays actual roll attitude through movable index and fixed reference marks at 0, 10, 20, 30, 60 and 90 degrees.
19. NON-SLAVED DIRECTIONAL GYRO - Provides a stable visual indication of aircraft heading to the pilot and provides electrical heading information to the autopilot.
20. HEADING BUG - Moved by HDG knob on DG or PUSH Δ Knob on Slaved DG or PUSH CARD SET Δ Knob on HSI's to select desired heading.
21. LUBBER LINE - Indicates aircraft heading on compass card (22).
22. COMPASS CARD - Rotates to display heading of airplane with reference to lubber line (21) on DG's or HSI.
23. HEADING SELECTOR KNOB (HDG) - When pushed in, the heading bug (20) may be positioned to the desired magnetic heading by rotating the HDG selector knob. Also used to select VOR or ILS course.

Figure 1. Cessna 400B Navomatic Autopilot (Type AF-550A)
(Sheet 4 of 6)

24. **GYRO ADJUSTMENT KNOB (PUSH)** - When pushed in, allows the pilot to manually rotate the gyro compass card (22) to correspond with the magnetic heading indicated by the compass. The unslaved directional gyro's (19) compass card (22) must be manually reset periodically to compensate for precessional errors in the gyro. The slaved directional gyro's (37) compass card (22) will automatically realign itself due to the slaving features. However the slaved DG may be manually reset at any time in order to accelerate precession adjustment.
25. **NON-SLAVED HORIZONTAL SITUATION INDICATOR (HSI)** - Provides a pictorial presentation of aircraft deviation relative to VOR radials and localizer beams. It also displays glide slope deviations and gives heading reference with respect to magnetic north. The unslaved HSI's directional gyro compass card (22) must be manually reset periodically to compensate for precessional errors in the gyro.
26. **OMNI BEARING POINTER** - Indicates selected VOR course or localizer course on compass card (22). The selected VOR radial or localizer heading remains set on the compass card when the compass card (22) is rotated.
27. **HEADING WARNING FLAG (HDG)** - When HDG flag is in view, the heading display is invalid due to interruption of either electrical or vacuum power.
28. **NAV FLAG** - Flag is in view when the NAV receiver signal is inadequate.
29. **COURSE DEVIATION BAR** - Bar is center portion of omni bearing pointer and moves laterally to pictorially indicate relationship of aircraft to selected course. It relates in degrees of angular displacement from VOR radials or localizer beam center.
30. **COURSE DEVIATION DOTS** - A course deviation bar displacement of 2 dots represents full scale (VOR = $\pm 10^\circ$ or LOC = $\pm 2\frac{1}{2}^\circ$) deviation from beam centerline.
31. **TO/FROM INDICATOR FLAG** - Indicates direction of VOR station relative to selected course.
32. **HEADING SELECTOR KNOB (PUSH/CARD SET/ Δ)** - Positions heading "bug" on compass card (22) by rotating the CARD SET knob. Pushing in and rotating the CARD SET knob sets the compass card. The "bug" (20) rotates with the compass card. Also used to select VOR or ILS course.
33. **COURSE SELECTOR KNOB** - Positions omni bearing pointer (26) on the compass card (22) by rotating the course selector knob.
34. **GLIDE SLOPE SCALE** - Indicates displacement from glide slope beam center. A glide slope deviation bar displacement of 2 dots, represents full scale (0.7°) deviation above or below glide slope beam centerline.
35. **GLIDE SLOPE FLAG** - When in view, indicates glide slope receiver signal is not reliable.
36. **GLIDE SLOPE POINTER** - Indicates on glide slope scale (34) aircraft displacement from glide slope beam center.

Figure 1. Cessna 400B Navomatic Autopilot (Type AF-550A)
(Sheet 5 of 6)

37. **OPTIONAL SLAVED DIRECTIONAL GYRO** - When properly set to agree with the magnetic compass, the slaved DG will provide a magnetically stabilized visual indication of aircraft heading and also provides electrical heading information to the autopilot. The slaved DG eliminates the need to manually compensate for precessional errors in the gyro since the gyro motor will keep the card aligned with the earth's magnetic field.
38. **GYRO SLAVING INDICATOR** - Displays visual indication of heading indicator and flux detector synchronization. When slaving needle is aligned with the 45° right index on the DG or HSI, it shows that the heading indicator agrees with the aircraft magnetic heading. Off-center pointer deflections show the direction of the heading indicator error relative to aircraft magnetic heading. The slaved HSI's (41) compass CARD SET knob (32) or the slaved DG's gyro adjustment knob (24) may be used at any time to more rapidly accomplish synchronization of the heading indicator reading with magnetic heading as indicated by the slaving indicator.
39. **HEADING SELECTOR KNOB (PUSH/Δ)** - When pushed in the heading bug (20) may be positioned to the desired magnetic heading by rotating the PUSH/Δ selector knob. Also used to select VOR or ILS course.
40. **SLAVING OFF WARNING FLAG** - When out of view, indicates adequate slaving voltage. When in view, indicates absent or low slaving voltage.
41. **SLAVED HORIZONTAL SITUATION INDICATOR (HSI)** - Provides a pictorial presentation of aircraft deviation relative to VOR radials and localizer beams. It also displays glide slope deviations and gives heading reference with respect to magnetic north. The slaving feature associated with the HSI's directional gyro compass card (22) eliminates the need to manually compensate for precessional errors in the gyro. However, the slaved DG may be manually reset at any time in order to accelerate precessional adjustment.
42. **AUTOPILOT AND ELECTRIC TRIM DISCONNECT PUSHBUTTON (AP/TRIM DISC)** - When the red pushbutton is pressed, trips the AP ON/OFF switch to OFF. Autopilot will remain OFF until AP ON/OFF switch is turned ON. Pulling out the A/P ACT circuit breaker will also shut the Autopilot OFF.

This switch will disconnect the electric trim system only if there is a malfunction in the system, otherwise it serves only a momentary OFF function. A secondary method of electric trim disengagement is provided by the ELECT TRIM/PULL OFF circuit breaker: pull out to remove all electrical power to the electric trim system.
43. **ELECTRIC TRIM SWITCH** - When both segments are simultaneously moved forward to the DN position, the elevator trim tab moves in the "nose-down" direction; conversely, pulling the segments aft simultaneously to the UP position moves the trim tab in the "nose-up" direction. The electric trim switch is only operational with the autopilot AP ON/OFF switch OFF.

Figure 1. Cessna 400B Navomatic Autopilot (Type AF-550A)
(Sheet 6 of 6)

SECTION 3

EMERGENCY PROCEDURES

IN CASE OF AUTOPILOT MALFUNCTION:

1. Airplane Control Wheel -- OPERATE as required to manually override the autopilot.

NOTE

The servos may be manually overpowered at any time without damage. If pitch axis is overpowered, electric trim will run in opposition to overpowering force. Manually overpowering the autopilot should be kept to a minimum since slip clutch wear will result from extended periods of manual overpower.

2. AP/TRIM DISC Pushbutton -- PRESS to disconnect autopilot and observe that the Autopilot Disengage Warning Horn sounds with a short tone lasting from 1 to 2 seconds with decreasing amplitude.

NOTE

This action automatically trips autopilot ON-OFF switch OFF. If electrical malfunction still persists, turn avionics power switch OFF and, if necessary, also turn the airplane master switch OFF.

3. AP/ACT Circuit Breaker -- PULL OFF for remainder of the flight.

SECTION 4

NORMAL PROCEDURES

BEFORE TAKEOFF RELIABILITY TESTS:

1. Electric Trim Preflight Test -- SEE Electric Elevator Trim System Supplement in this section and conduct the electric trim preflight test to verify proper operation of the electric trim system.
2. Autopilot Automatic Disconnect Check (with Engine Running and Gyros Erected) -- PERFORM the following checks.
 - a. PULL-TURN Knob -- CENTER and PULL OUT.
 - b. Autopilot Lateral TRIM Control -- CENTER.

- c. AP ON-OFF Rocker Switch -- ON.

NOTE

The roll servo will engage immediately. The pitch servo will engage after pitch synchronization as evidenced by the autopilot pitch command wheel coming to rest.

- d. Airplane Control Wheel -- HOLD to reduce movement.
- e. Autopilot Disconnect TEST Prior To EA FLT Button -- PUSH and HOLD.
- f. Verify the following:
 - (1) AP ON-OFF Rocker Switch -- OBSERVE disengage to OFF position.
 - (2) Autopilot DISC WARN Light -- OBSERVE yellow illumination.
 - (3) Autopilot Disengage Horn -- OBSERVE 1 to 2 second aural tone.
- g. Airplane Control Wheel AP/TRIM DISC Pushbutton -- PRESS to turn off autopilot DISC WARN light.

BEFORE TAKEOFF AND LANDING:

- 1. AP ON-OFF Rocker Switch -- PUSH OFF.
- 2. REV SNS LOC 1/LOC 2 Switch (on Autopilot Accessory Unit) -- OFF.

IN-FLIGHT WINGS LEVELING:

- 1. Airplane Elevator and Rudder Trim -- ADJUST.
- 2. PULL-TURN Knob -- CENTER and PULL OUT.
- 3. AP ON-OFF ROCKER SWITCH -- PUSH ON.
- 4. Lateral TRIM Knob -- ADJUST to level wings.
- 5. Pitch Command Wheel -- ADJUST as desired.

ALTITUDE HOLD:

- 1. ALT Rocker Switch -- PUSH to hold altitude.

NOTES

The autopilot ON-OFF switch must be engaged for a short time (maximum of 30 seconds) before the ALT switch can be engaged.

Altitude Hold mode will automatically disengage on a coupled ILS approach when the glide slope is captured.

2. Airplane Rudder Trim -- ADJUST.
3. Lateral TRIM -- ADJUST to level wings.

COMMAND TURNS:

1. PULL-TURN Knob -- PULL OUT and ROTATE as desired.

CLIMB OR DESCENT:

1. ALT Rocker Switch -- DISENGAGE.
2. Pitch Command Wheel -- ROTATE UP or DOWN as desired.
3. Rudder Trim -- ADJUST as required.

HEADING SELECT:

1. PUSH Knob on DG or HSI -- SET to aircraft magnetic heading.
2. HDG Knob on DG or CARD SET Knob on HSI -- ROTATE bug to desired heading.
3. NAV Rocker Switch -- OFF.
4. PULL-TURN Knob -- PUSH IN.

NOTE

Airplane will turn automatically to selected heading.

VOR COUPLING:

1. PULL-TURN Knob -- PULL OUT.
2. AP NAV 1/NAV 2 Selector Switch (on Autopilot Accessory Unit) -- SET to desired VOR receiver.
3. Nav Indicator OBS or Course Selector Knob on HSI -- SET VOR course.
4. HDG Knob on DG or CARD SET Knob on HSI -- ROTATE bug to agree with OBS.
5. PULL-TURN Knob -- PUSH IN.
6. NAV Rocker Switch -- ON (within 135° of desired heading).

NOTE

Airplane will automatically intercept and then track the selected VOR course. The NAV rocker switch must be turned OFF when the selected VOR course is changed, and then ON again.

ILS/LOC APPROACH:

1. Wing Flaps -- SELECT desired 0° to 20° approach setting.

NOTE

Extending wing flaps to 10° when the gear is lowered tends to cancel out the resulting pitch reactions and results in smoother autopilot operation.

2. Airspeed -- ADJUST to recommended approach speed (80 to 95 KIAS - Flaps 10°-20°, 105 to 120 KIAS - Flaps 0°-10°).
3. Rudder Trim -- ADJUST as required.
4. PULL-TURN KNOB -- PULL out and turn airplane to within 30° to 45° of localizer heading.
5. A/P NAV 1/NAV 2 Selector Switch (on Autopilot Accessory Unit) -- SET for NAV 1 receiver.
6. REV SNS LOC 1/LOC 2 Selector Switch (on Autopilot Accessory Unit) -- SELECT only if intercepting localizer front course outbound or back course inbound.

CAUTION

When Rev SNS switch is placed in the LOC 1 or LOC 2 position (on Autopilot Accessory Unit), and a localizer frequency is selected, the CDI on the selected Nav radio will be reversed even when the autopilot switch is OFF.

NOTE

Selection of LOC 1 or LOC 2 will only reverse the vertical needle on a Course Deviation Indicator. When the optional Horizontal Situation Indicator is installed, operation of the HSI needle is unaffected by the selection of LOC 1 or LOC 2. However, selection of LOC 1 or LOC 2 (corresponding to the selected A/P NAV 1/NAV 2 switch position) will always cause the localizer signal to the autopilot to reverse for back-course operation.

7. Nav Indicator OBS or Course Selector Knob on HSI -- SET to localizer front course heading for both front and back course approaches.
8. HDG Knob on DG or CARD SET Knob on HSI -- ROTATE bug to localizer course (inbound or outbound as appropriate).
9. PULL-TURN Knob -- PUSH.
10. NAV Rocker Switch -- ON for automatic intercept and ILS tracking.

11. ALT Rocker Switch -- ON when at published approach altitude.

NOTE

Autopilot can only capture glide slope from below beam center.

12. ALT Rocker Switch:
CHECK -- AUTOMATIC DISENGAGEMENT at glide slope capture.
OFF -- AT FINAL APPROACH FIX if localizer approach only.
13. Autopilot PITCH Command Wheel -- ADJUST for proper descent if localizer approach only.
14. Landing Gear -- EXTEND by outer marker.
15. AP/TRIM DISC Pushbutton (on Control Wheel) -- PRESS to disconnect autopilot before landing or when executing missed approach.
16. Wing Flaps -- EXTEND as required after landing is assured.

SECTION 5 PERFORMANCE

There is no change to the airplane performance when this avionic equipment is installed.



S-TEC CORPORATION
RT. 3, BLDG. 946
WOLTERS INDUSTRIAL COMPLEX
MINERAL WELLS, TEXAS 76067
FAA APPROVED SUPPLEMENT
TO
PILOT'S OPERATING HANDBOOK AND/OR
FAA APPROVED AIRPLANE FLIGHT MANUAL
FOR
CESSNA MODELS
R182 AND TR182
WITH
S-TEC SYSTEM 60 PITCH
STABILIZATION SYSTEM
(28 VOLT SYSTEM)

REG. NO. VH-8DP *NDD*

SER. NO. R1820177

This Supplement must be attached to the applicable FAA Approved Airplane Flight Manual, Pilot's Operating Handbook, or Pilot's Operating Handbook and FAA Approved Airplane Flight Manual modified by the installation of S-TEC System 60 Pitch Stabilization System Model ST-061 installed in accordance with STC SA 5204SW-D. The information contained herein supplements the information of the basic POH and/or AFM; for Limitations, Procedures and Performance information not contained in this Supplement, consult the basic POH and/or AFM.

SECTION I

GENERAL

This manual is to acquaint the pilot with the features and functions of the System 60 Pitch Stabilization System when installed in the listed aircraft model(s). The aircraft must be operated within the limitations herein provided when the pitch system is in use.

SECTION II

OPERATING LIMITATIONS

1. Pitch System operation not authorized above 160 KIAS.
2. Flap extension limited to 20° maximum and 10° between 140 KIAS and 95 KIAS, when optional autotrim system is installed and operating.
3. Flap extension limited to 10° and 95 KIAS, or below, when optional Autotrim System is not installed.
4. Pitch System use prohibited during a missed approach or go-around maneuver.
5. Pitch System must be off during take-off and landing.
6. During operation of the Pitch System, limit bank angles to 30° or less.

FAA/DAS APPROVED
P/N 8968-1
DATE: 9-12-83



S-TEC CORPORATION
MINERAL WELLS, TEXAS 76067

SECTION III

EMERGENCY OPERATING PROCEDURES

In the event of pitch system malfunction, or any time the system is not performing as expected or commanded, do not attempt to identify the system problem. Immediately regain control of the aircraft by overpowering the pitch axis as necessary and then immediately disconnect the system. Do not reengage the system until the problem has been identified and corrected.

1. Disconnect (Standard System Without Autotrim)

The system may be disconnected by:

- a. Depressing the OFF Switch on the programmer unit.
- b. Placing the PITCH STAB Switch in the OFF position.

2. Disconnect (Systems with Autotrim)

- a. In the event of a failure, manually control aircraft and DEPRESS AND HOLD, "Trim Interrupt/Pitch Stab Disconnect Switch" on control wheel.
- b. Place Trim Master Switch in OFF position, pull trim circuit breaker, release interrupt switch.
- c. Retrim aircraft. Leave trim system OFF until corrected.

NOTE: Activation of the disconnect/interrupt switch will disconnect the pitch system and interrupt electric trim operation while the switch is depressed.

3. Altitude Loss During A Malfunction:

- a. A pitch system or autotrim malfunction during climb, cruise, or descent with a three second delay in recovery initiation could result in as much as a 550 ft. altitude loss. Maximum altitude loss recorded in a descent.
- b. A pitch system or autotrim malfunction during an approach with one second delay in recovery initiation could result in as much as 80 ft. altitude loss. Maximum altitude loss measured with flaps down 10⁰, gear down and operating either coupled or uncoupled.

4. Caution Annunciations:

The pitch stabilization system includes the following caution annunciations to advise the pilot of potential operating problems. Following is a list of the annunciations, their cause and recommended pilot actions.



S-TEC CORPORATION
MINERAL WELLS, TEXAS 76067

<u>ANNUNCIATION</u>	<u>CONDITIONS</u>	<u>ACTION</u>
A. Flashing "VS"	Indicates excessive vertical speed error over selected VS (usually in climb).	Reduce command VS and/or adjust power
B. Flashing "GS"	Indicates off glide slope center line by 50% and/or glide slope flag in view	Check attitude and power and glide slope raw data display for flag. Add or reduce power as necessary for off course - check radio, execute missed approach, if glide slope flag extended.

NOTE: If any of the above annunciations occur at low altitude or during an actual instrument approach disconnect the system execute a go-around and inform ATC of the problem (IFR). Do not attempt to trouble shoot or otherwise ascertain the nature of the failure until a safe altitude and maneuvering area is reached.

SECTION IV

NORMAL OPERATING PROCEDURES

4-1 SYSTEM DESCRIPTION

The System 60 Pitch Stabilization System is a pure rate system providing control of the aircraft pitch axis. The system does not include or use a gyro or any of the panel instruments.

Pitch axis control is provided by deriving vertical speed, altitude position, altitude error and rate of vertical speed (acceleration) from a solid state absolute pressure transducer. The basic pitch modes provided are vertical speed, for use in climbs and descents, and altitude hold for maintaining a selected altitude (pressure) level. Pitch attitude changes to accomplish commands are limited by acceleration in operation, providing a very slow, comfortable, maneuvering rate.

The programmer unit includes an ambient light sensor which automatically adjusts annunciator and knob light intensity for prevailing ambient conditions. The system is entirely electrical and operates with very low power consumption.

FAA/DAS APPROVED
P/N 8968-1
DATE: 9-12-83



S-TEC CORPORATION
MINERAL WELLS, TEXAS 76067

4-2 COCKPIT CONTROLS AND FUNCTIONS

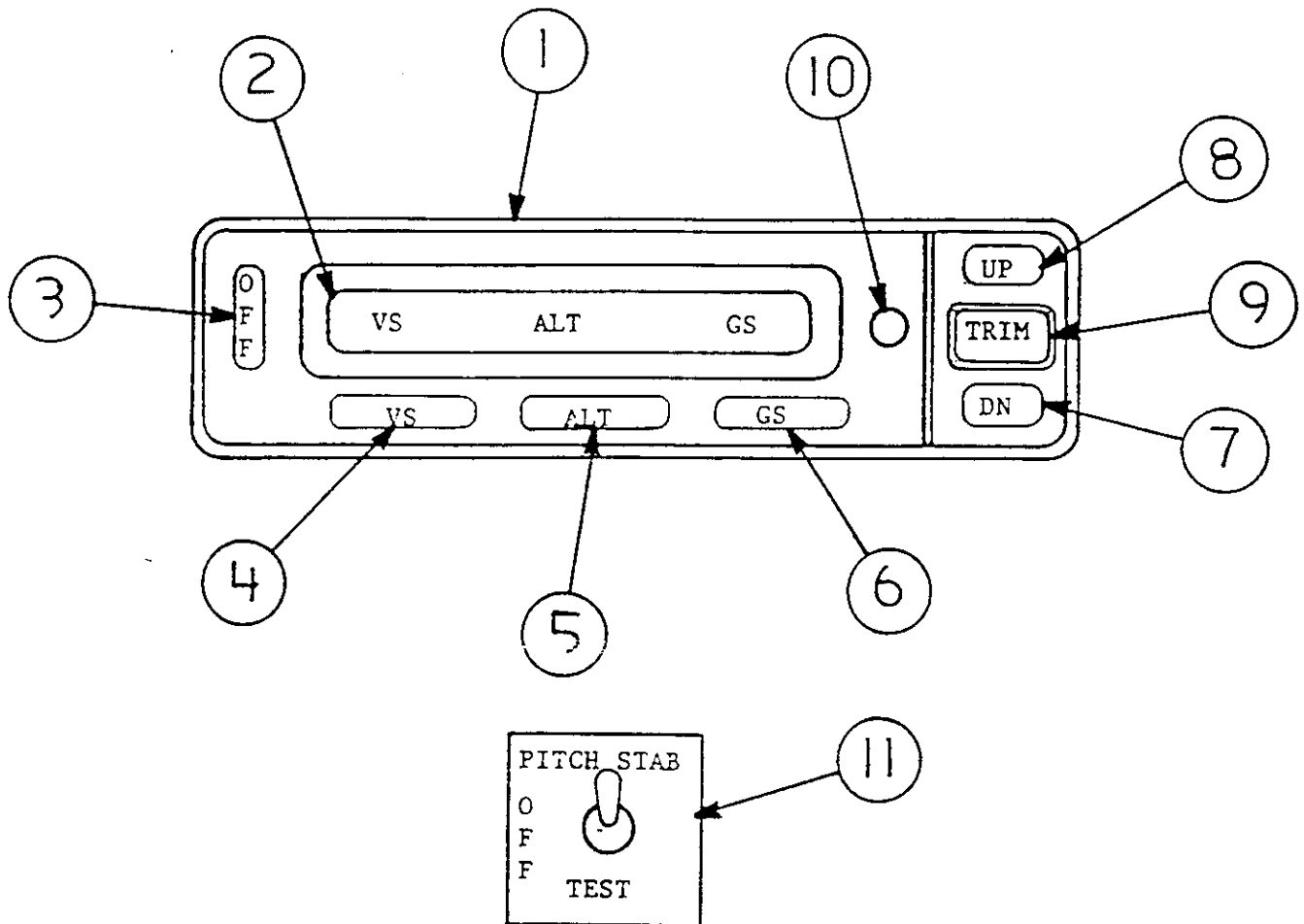

1. Mode Programmer and Annunciator Unit - Provides mode switches and annunciation for the system.
2. Mode Annunciator Window - Displays modes in use and armed modes (to the right of the active mode).
3. OFF - System disengage switch. Momentary actuation will clear all modes and disengage pitch servo.
4. VS (Vertical Speed) Mode Switch - Momentary actuation engages vertical speed mode. At engagement the system will synchronize the autopilot to the vertical speed existing at engagement.

FAA/DAS APPROVED
P/N 8968-1
DATE: 9-12-83



S-TEC CORPORATION
MINERAL WELLS, TEXAS 76067

NOTE: The vertical speed limits of the autopilot are ± 1500 FPM
If the autopilot is engaged above 1500 FPM, it will maneuver
to produce 1500 FPM.

5. ALT (Altitude) Mode Switch - Momentary actuation engages the altitude hold mode at the altitude existing at engagement.
6. GS (Glide Slope) Mode Switch - Momentary actuation will arm the GS mode when the aircraft is under the GS centerline. When armed the GS mode will engage automatically when the aircraft reaches the GS centerline. If the aircraft is above the GS centerline, momentary activation will engage the GS mode. Arming is indicated by the GS annunciation appearing with the ALT annunciation. At engagement, the ALT annunciation will extinguish leaving the GS annunciation.
7. DN (Down) Pitch Modifier Switch - The down modifier switch is used to modify the commanded vertical speed in VS mode or the altitude in altitude mode.

VERTICAL SPEED

In VS mode the down pitch modifier switch is used to increase descent vertical speed or decrease climb vertical speed, approximately 160 FPM per each second of actuation, i.e. a three second actuation will provide a VS change of approximately 500 FPM.

ALTITUDE CHANGE

In ALT mode the DN modifier switch will lower the altitude reference 20' per each second of actuation.

8. UP Pitch Modifier Switch - The UP pitch modifier switch is used to increase climb vertical speed and decrease descent vertical speed. In ALT mode it will cause an increase in the reference altitude. The rates of change are explained above for the down modifier (Item 7).
9. Trim Annunciation - Illuminates in conjunction with the appropriate UP/DN modifier switch button to indicate an out of trim condition and the direction to trim in order to reestablish a trimmed pitch condition.
10. Ambient light sensor - will adjust annunciator lamp and knob recognition lamp intensity automatically for optimum brilliance level.
11. PITCH STAB switch provides power to the Pitch Stabilization System. The switch is a three position switch having a PITCH STAB position, center OFF position and a TEST position.

FAA/DAS APPROVED -

P/N 8968-1

DATE: 9-12-83



S-TEC CORPORATION
MINERAL WELLS, TEXAS 76067

4-3 PRE-FLIGHT PROCEDURES

NOTE: During system functional checks the system must be provided adequate D.C. voltage (12.0 VDC or 24 VDC minimum, as appropriate).

1. PITCH STAB Switch - Move to Test Position - Observe all messages illuminate. Move control wheel to center and push VS mode switch, move control wheel to check for engagement of the pitch servo. Hold control wheel and depress and hold UP modifier switch - after approximately $\frac{1}{2}$ second pitch servo should disconnect. Release UP Modifier Switch - pitch servo should re-engage. Repeat for DN modifier switch. Move switch to PITCH STAB position.

NOTE: The above pitch limiter check should be conducted once each flight day. If pitch servo does not disengage controls when UP and DN modifier switch are momentarily selected, the limit accelerometer may have failed. The pitch stabilization system should not be used until the problem is corrected.

2. Move control wheel to level flight position - Engage VS Mode - Depress UP Modifier Switch and hold - Observe control wheel moves slowly OUT. Depress DN Modifier Switch and hold - Observe control wheel moves slowly - IN.
3. Overpower Pitch By Pulling Control Wheel Out - Observe that TRIM Annunciator illuminates and DN modifier illuminates with audio tone - Overpower by pushing control wheel IN - Observe that TRIM annunciator illuminates and UP modifier illuminates with audio tone.

NOTE: There will be approximately a 2-3 second delay between the overpower and the trim indication. If the trim lights do not function the system should not be used until the problem is corrected.

4. Disconnect - Momentarily depress the OFF switch. Move control wheel to assure freedom of the controls.
5. Electric Trim Check (If Optional Autotrim is installed)

Manual Electric Trim - Test Prior To Each Flight

- A. Trim Switch and Pitch Stab Switch - ON
- B. Operate Manual Trim Switch (Both knob sections)
 - NOSE DN - Check trim moves nose down and trim in motion indicator ("TRIM") in Pitch Stabilizer Programmer flashes. Operate trim switch
 - NOSE UP - Check trim moves up and for "in motion" light.

FAA/DAS APPROVED

P/N 8968-1

DATE: 9-12-83



S-TEC CORPORATION
MINERAL WELLS, TEXAS 76067

- C. With trim operating nose up and down - grasp manual trim control and overpower electric trim.
- D. Operate each half of the trim switch separately - trim should not operate unless both switch knob segments are moved together.
- E. With Trim Operating - Depress trim interrupt switch - Trim motion should stop while interrupt switch is depressed - when released trim should operate normally.

Autotrim

- A. Engage VS mode of the pitch system.
- B. Grasp control wheel and apply forward pressure (nose down) - After approximately three (3) seconds trim should run NOSE UP.
- C. Apply aft pressure (Nose UP) to control wheel - after approximately three (3) seconds trim should run NOSE DOWN.
- D. Move manual trim switch UP or DN - Pitch System should disconnect and trim operates in the commanded direction.
- E. Re-engage VS mode and depress Trim Interrupt/Pitch Stab Disconnect Switch - Pitch System should disconnect.
- F. Retrim aircraft for take-off - Check all controls for freedom of motion and to determine that the pitch system and trim have disconnected.

If either the manual electric or autotrim fails any portion of the above check procedure, move the trim master switch OFF and do not attempt to use the trim system until the fault is corrected. With the trim master switch "OFF" the pitch system trim indicators and audio system will return to operation. If the electric trim system suffers a power failure in flight, the system will automatically revert to the indicator lights and audio horn. If this occurs turn the trim master switch OFF and trim manually, using the indicators, until the fault can be located and corrected.

4-4 IN FLIGHT PROCEDURES

VERTICAL SPEED

- 1. Place system switch in - PITCH STAB position - (Allow 10-15 seconds before engagement).
- 2. Engage VS Mode. Vertical speed mode will synchronize to the vertical speed existing at engagement if it is less than 1500 FPM. If the VS at engagement is more than 1500 FPM, the system will hold 1500 FPM.
- 3. To modify (change) vertical speed - Depress the desired UP-DN modifier switch as necessary. The UP-DN modifier switch will change the reference vertical speed approximately 160 FPM per each second of actuation. Thus to increase VS 500 FPM it will be necessary to hold the UP modifier for approximately three (3) seconds.



S-TEC CORPORATION
MINERAL WELLS, TEXAS 76067

NOTE: The systems response to a command VS change is slow. When the modifier switch is depressed the aircraft will change attitude very slowly in the direction commanded. Do not hold the modifier switch depressed until the attitude change looks correct - remember the amount of modification is time related, 160 FPM per second of actuation.

ALTITUDE HOLD

1. At the desired altitude, depress the ALT Mode Switch. The ALT Hold will engage at the precise pressure level existing at engagement. In the event, that a difference exists between the altitude engage point and the altimeter the altitude may be modified as follows.
2. To modify the selected altitude, depress the UP-DN modifier switch, in the direction of desired change, for the required time period. The UP-DN modifier switch will change the reference altitude 20 feet per second of switch activation, i.e. if a barometric change requires a 40' climb to return to the desired altitude, depress the UP modifier switch for approximately two seconds. The aircraft will slowly change altitude to the new reference.

NOTE: The total range of the modifier in ALT mode is 200 feet of change. If more than 200 feet of change is required after ALT mode engagement, it will be necessary to return to VS mode and reselect ALT mode when the desired altitude is reached.

GLIDE SLOPE

The glide slope mode must be manually ARMED using the GS Mode Switch on the programmer. If the aircraft is below the glide slope centerline, actuation of GS mode switch will cause the GS mode to ARM, lighting the GS annunciator in addition to the ALT Annunciator. If the aircraft is above or on the GS centerline, actuation of the GS Mode Switch will arm and immediately engage the GS mode, which will extinguish the ALT annunciation leaving the GS annunciation illuminated. The GS mode can only be armed when operating in altitude (ALT) mode.

MANUAL ARM - AUTOMATIC ENGAGE

1. Check NAV Receiver on correct ILS frequency and that GS signal is valid (no flag).
2. Pitch Stabilization System in ALT mode, in bound to outer marker (O.M. or L.O.M.).
3. Select GS Mode Switch - GS Annunciator will illuminate indicating GS armed. At GS intercept the ALT annunciator will extinguish, leaving the GS annunciator and automatically engaging GS mode.

FAA/DAS APPROVED

P/N - 8968-1

DATE 9-12-83



S-TEC CORPORATION
MINERAL WELLS, TEXAS 76067

MANUAL ARM - MANUAL CAPTURE

If radar vectoring results in the aircraft being above the glide slope at the intercept point, the GS mode may be manually engaged as follows:

1. Select ALT mode (system will not arm from VS Mode).
2. Select GS Mode.

NOTE: If the glide slope receiver indicator is equipped with an external flag output which is connected to the pitch stabilization system, a GS flag in view will inhibit the glide slope mode. If the flag extends once the glide slope is engaged the GS annunciator will flash providing an active GS warning.

GLIDE SLOPE FLIGHT PROCEDURE

Approach the intercept point (usually the L.O.M.) with the flaps set to approach deflection of 10° - 20° (See Limitations Section) and with the aircraft stabilized in altitude hold mode (ALT). Determine the GS signal is valid (no flag) and arm the GS by a momentary actuation of the GS Switch. At glide slope intercept, ~~lower the landing gear~~ and reduce the power for the desired descent speed. For best tracking results make power adjustments in small, smooth increments to maintain the desired airspeed. At the missed approach point or the decision height, disconnect the pitch stabilization system by actuation of the "OFF" Switch. If a missed approach is required, the system may be re-engaged after the aircraft has been reconfigured for and established in a stabilized climb.

ELEVATOR TRIM INDICATOR

The system pitch servo contains a sensor to detect the out of trim loads being imposed on the servo during maneuvers producing a trim change. When the out of trim force exceeds a preset amount, the TRIM annunciator will illuminate along with the UP-DN modifier switch button to indicate the direction of required trim. The annunciators will be accompanied by a low level audio signal, and will be steady for approximately five seconds and will flash thereafter, until the aircraft is retrimmed. For instance, if the TRIM and UP lights are illuminated, you must TRIM UP to extinguish the lights and restore trim.

NOTE: If the trim indicator is illuminated and the system is disconnected there will be a residual out of trim force at the control wheel - be alert for this condition if you disconnect the system with the trim lights ON.



S-TEC CORPORATION
MINERAL WELLS, TEXAS 76067

AUTOTRIM (IF OPTIONAL AUTOTRIM IS INSTALLED)

If the pitch system is equipped with the optional electric autotrim system, the aircraft elevator trim will be maintained automatically when the TRIM Master Switch is ON and a pitch mode is selected. When autotrim is on, the trim indicator lights are disabled. Should the trim power fail or the switch be OFF, the indicator lights will return to operation automatically. Refer to Section 4-3 Pre-Flight Procedures for check-out information. The S-TEC electric trim system is designed to accept any type of single failure (either electrical or mechanical) without uncontrolled operation resulting. To assure that no hidden failures have occurred, conduct the trim preflight check prior to each flight.

NOTE: With optional autotrim system installed, do not overpower autopilot pitch axis for more than three (3) seconds because autotrim will operate to oppose the pilot causing an increase in overpower loads. If necessary to overpower the pitch axis, immediately disconnect the autopilot using the control wheel disconnect switch.

ALTITUDE SELECTOR/VERTICAL SPEED SELECTOR (OPTIONAL)

The Altitude Selector option is available in two versions, one with altitude pre-select capability and the other with altitude and vertical speed pre-select capability. The altitude selector option operates in conjunction with an altitude encoder and transponder. For pre-flight and normal operating procedures refer to the "Pilot's Operating Handbook and Altitude Selector and Altitude/Vertical Speed Selector", P/N 8702, dtd. 1-81. This option does not effect the limitations or emergency procedures section of this supplement.

SECTION V

OPTIONAL DATA

Text of this Section not affected by installation of this equipment.

SECTION VI

REQUIRED OPERATING EQUIPMENT

Text of this Section not affected by installation of this equipment.

SECTION VII

WEIGHT AND BALANCE

Text of this Section not affected by installation of this equipment.

APPROVED _____

James L. Irwin
James L. Irwin

S-TEC CORPORATION

DAS 5 SW

P/N: 8968-1

DATE: 9-12-83

