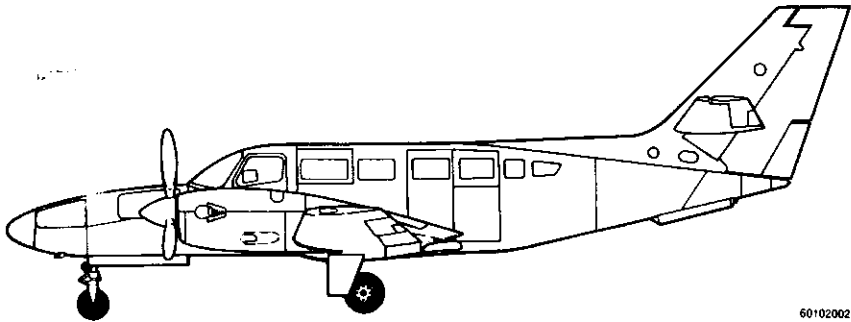




Information Manual



60102002



Cessna Aircraft Company

Model 406

THIS MANUAL INCORPORATES INFORMATION ISSUED THRU REVISION 2 TO THE PILOT'S OPERATING HANDBOOK AND FAA APPROVED AIRPLANE FLIGHT MANUAL DATED 1 JULY 1986.

COPYRIGHT © 1995

Cessna Aircraft Company
Wichita, Kansas USA

CONTENTS

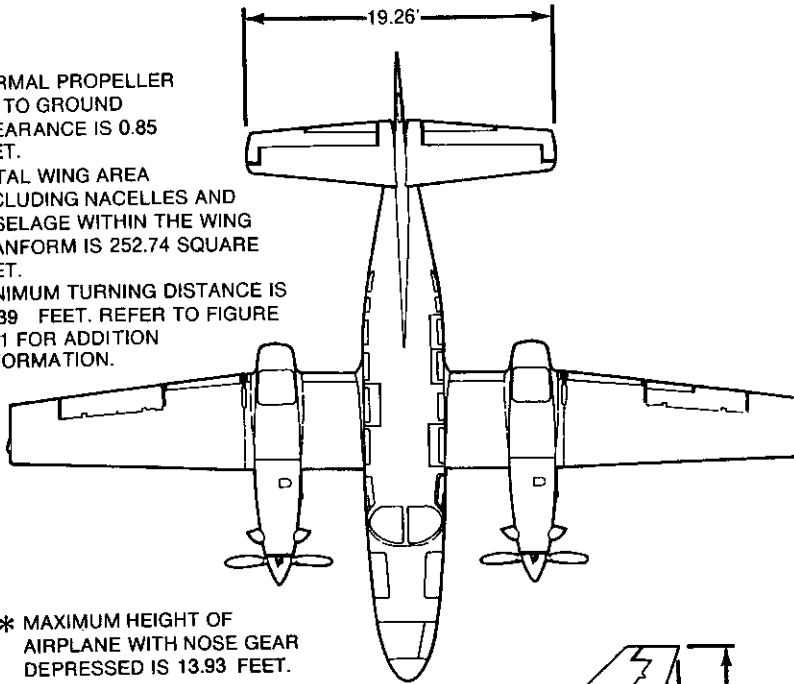
| SECTION | PAGE |
|---|---------|
| 1 GENERAL | 1-1 |
| 2 LIMITATIONS | 2-1 |
| 3 EMERGENCY PROCEDURES | 3-1 |
| 4 NORMAL PROCEDURES | 4-1 |
| 5 PERFORMANCE | 5-1 |
| 6 WEIGHT AND BALANCE | 6-1 |
| 7 DESCRIPTION OF THE AIRPLANE AND ITS SYSTEMS | 7-1 |
| 8 HANDLING, SERVICE AND MAINTENANCE | 8-1 |
| 9 SUPPLEMENTS | 9-1 |
| ALPHABETICAL INDEX | Index-1 |

SECTION I
GENERAL

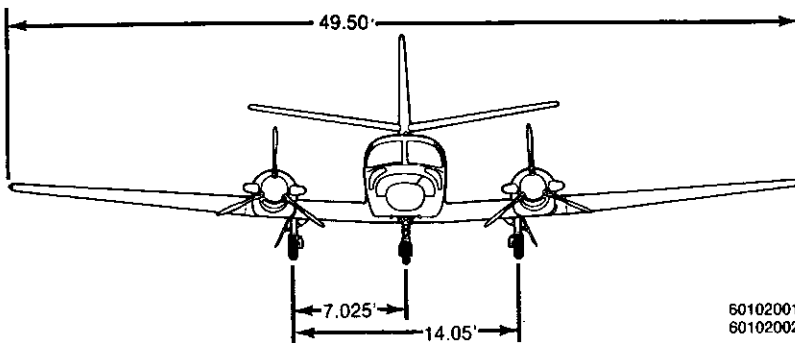
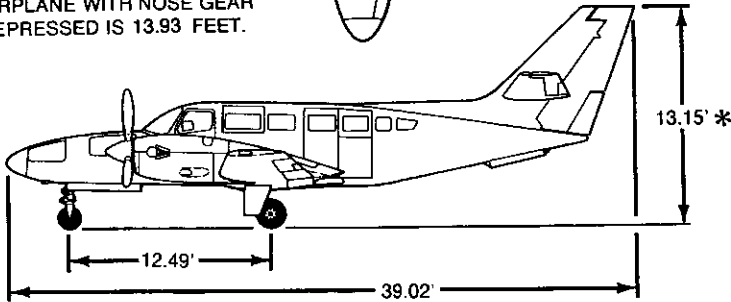
TABLE OF CONTENTS

| | Page |
|--|------|
| THREE-VIEW DRAWING | 1-2 |
| INTRODUCTION | 1-3 |
| ENGINES | 1-4 |
| PROPELLERS | 1-4 |
| FUEL | 1-5 |
| OIL | 1-6 |
| MAXIMUM CERTIFICATED WEIGHTS | 1-6 |
| STANDARD AIRPLANE WEIGHTS | 1-8 |
| CABIN, BAGGAGE AND ENTRY DIMENSIONS | 1-9 |
| SPECIFIC LOADINGS | 1-11 |
| SYMBOLS, ABBREVIATIONS AND TERMINOLOGY | 1-11 |
| General Airspeed Terminology and Symbols | 1-11 |
| Meteorological Terminology | 1-13 |
| Power Terminology | 1-14 |
| Engine Controls and Instruments Terminology | 1-15 |
| Airplane Performance and Flight Planning Terminology | 1-16 |
| Weight and Balance Terminology | 1-17 |

1. NORMAL PROPELLER TIP TO GROUND CLEARANCE IS 0.85 FEET.
2. TOTAL WING AREA INCLUDING NACELLES AND FUSELAGE WITHIN THE WING PLANFORM IS 252.74 SQUARE FEET.
3. MINIMUM TURNING DISTANCE IS 63.39 FEET. REFER TO FIGURE 7-11 FOR ADDITION INFORMATION.



* MAXIMUM HEIGHT OF AIRPLANE WITH NOSE GEAR DEPRESSED IS 13.93 FEET.



60102001
60102002

**Figure 1-1
THREE-VIEW DRAWING**

NOTICE

AT THE TIME OF ISSUANCE, THIS INFORMATION MANUAL WAS AN EXACT DUPLICATE OF THE OFFICIAL PILOT'S OPERATING HANDBOOK AND FAA APPROVED AIRPLANE FLIGHT MANUAL AND IS TO BE USED FOR GENERAL PURPOSES ONLY.

IT WILL ~~NOT BE~~ KEPT CURRENT AND, THEREFORE, CANNOT BE USED AS A SUBSTITUTE FOR THE OFFICIAL PILOT'S OPERATING HANDBOOK AND FAA APPROVED AIRPLANE FLIGHT MANUAL INTENDED FOR OPERATION OF THE AIRPLANE.

CESSNA AIRCRAFT COMPANY
ORIGINAL ISSUE - 1 JULY 1986

PERFORMANCE AND SPECIFICATIONS

WEIGHT:

| | |
|--|-------------|
| Maximum Ramp Weight | 9435 Pounds |
| Maximum Takeoff Weight | 9360 Pounds |
| Maximum Landing Weight | 9360 Pounds |
| Maximum Zero Fuel Weight With Zero Wing Locker Payload | 8500 Pounds |

* **SPEED At 8300 Pounds**

| | |
|---|----------|
| Maximum Cruise Power at 15,000 Feet | 246 KTAS |
|---|----------|

* **RANGE For 475 Gallons Usable At 6.7 Pounds per Gallon (3183 pounds)**

| | |
|----------------------|---|
| Maximum Cruise Power | |
| At 10,000 Feet | 1027 Nautical Miles 4.42 Hours 236 KTAS |
| At 20,000 Feet | 1281 Nautical Miles 5.40 Hours 244 KTAS |

Maximum Range Power

| | |
|----------------------|---|
| At 10,000 Feet | 1287 Nautical Miles 7.16 Hours 180 KTAS |
| At 20,000 Feet | 1652 Nautical Miles 8.54 Hours 194 KTAS |

RATE-OF-CLIMB AT SEA LEVEL:

| | |
|------------------------------|----------------------|
| All Engines | 1851 Feet Per Minute |
| One Engine Inoperative | 396 Feet Per Minute |

SERVICE CEILING:

| | |
|------------------------------|-------------------|
| All Engines | Above 30,000 Feet |
| One Engine Inoperative | 16,200 Feet |

TAKEOFF PERFORMANCE:

(Wing Flaps T.O. And 9360 Pounds Weight)

| | |
|--|-----------|
| Ground Roll | 2121 Feet |
| Total Distance Over 50-Foot Obstacle | 2635 Feet |

TAKEOFF FIELD LENGTH REQUIRED (Accelerate - Stop)

4227 Feet

LANDING PERFORMANCE:

(Wing Flaps LAND And 9360 Pounds Weight)

| | |
|--|-----------|
| Ground Roll | 1327 Feet |
| Total Distance Over 50-Foot Obstacle | 2485 Feet |

LANDING FIELD LENGTH REQUIRED (1/6 Factor Included)

4143 Feet

STANDARD EMPTY WEIGHT: (Approximate)

5033 Pounds

BAGGAGE ALLOWANCE:

1500 Pounds

WING LOADING:

37.03 Pounds Per Square Foot

POWER LOADING:

9.36 Pounds Per Horsepower

FUEL CAPACITY: (Total)

481.5 Gallons (475 Gallons Usable)

OIL CAPACITY: (Per Engine)

9.2 Quarts

ENGINES:

PRATT and WHITNEY CANADA INC.

PT6A-112 Free turbine engines, flat rated to 500 shaft horsepower at 1900 propeller RPM

PROPELLERS:

McCaughey 9910535-2

Constant Speed, Full And Auto Feathering, Reversible, Three-Bladed, 7.75 Feet Diameter

- * Range data includes allowances for start, taxi, takeoff, climb, descent and 45 m.p.h. reserve at the particular cruise power and altitude. Speeds shown are at mid-cruise weight.

The above performance figures are based on the indicated weights, standard atmospheric conditions, level hard-surface dry runways and no wind. They are calculated values derived from flight tests conducted by the Cessna Aircraft Company under carefully documented conditions and will vary with individual airplanes and numerous factors affecting flight performance.

INTRODUCTION

This handbook consists of 9 sections and an alphabetical index as shown on the Contents page. This handbook includes the material required to be furnished to the pilot by FAR Part 23 and SFAR 41. It also contains supplemental data supplied by Cessna Aircraft Company. Specific information can be rapidly found by referring to the Contents page for the appropriate section, then referring to the Table Of Contents on the first page of the appropriate section, or by the use of the Alphabetical Index.

NOTE

This handbook includes the material required to be furnished to the pilot by the Federal Aviation Regulations and additional information provided by Cessna Aircraft Company and constitutes the FAA Approved Airplane Flight Manual.

This handbook is not intended to be a guide for basic flight instruction or a training manual and should not be used as one. It is not a substitute for adequate and competent flight instruction, knowledge of current airworthiness directives, applicable federal air regulations or advisory circulars.

Assuring the airworthiness of the airplane is the responsibility of the airplane owner. Determining if the airplane is safe for flight is the responsibility of the pilot in command. The pilot is also responsible for staying within operating limitations as outlined by instrument markings, placards and this Pilot's Operating Handbook and FAA Approved Airplane Flight Manual.

Section 1 of this handbook presents basic airplane data and general information which will be of value to the pilot.

ENGINES

Number of Engines: 2

Manufacturer: Pratt and Whitney Canada Inc.
Engine Model Number: PT6A-112

Engine Type: Free Turbine,
Reverse Flow 2-Shaft.

Compressor Stages and Types: 3 axial stages,
1 centrifugal stage.

Combustion Chamber Type: Annular

Turbine Stages and Type: 1 stage compression,
1 stage power.

Horsepower: Flat rated at
500 shaft horsepower.
Takeoff and Max Continuous: 500 shaft horsepower.
Maximum Climb and Cruise: 500 shaft horsepower.

PROPELLERS

Number of Propellers: 2

Propeller Manufacturer: McCauley Accessory Division

Propeller Model Number: 9910535-2

Number of Blades: 3

Propeller Diameter: 7.75 Feet

Propeller Type: Constant speed, full and auto
feathering, reversible and
hydraulically actuated.

Propeller Blade Angle: (At 30-Inch Station)
a) Feathered 85.5 Degrees
b) Low Pitch 18.5 Degrees
c) Full Reverse -13.5 Degrees

FUEL

| FUEL GRADE (2) | FUEL SPECIFICATIONS | MINIMUM FUEL TEMPERATURE FOR TAKEOFF - °C (1) | SPECIFIC WEIGHT - POUNDS PER U.S. GALLON AT 80°F | COLOR |
|---|-----------------------------|--|---|--|
| JET A | ASTM-D1655 | -31 | 6.7 | COLORLESS |
| JET A-1 | ASTM-D1655 | -31 | 6.7 | COLORLESS |
| JET B | ASTM-D1655 | -54 | 6.7 | COLORLESS |
| JP-1 | MIL-L-5616 | -54 | 6.7 | COLORLESS |
| JP-4 | MIL-T-5624 | -54 | 6.5 | COLORLESS |
| JP-5 | MIL-T-5624 | -31 | 6.8 | COLORLESS |
| JP-8 | MIL-T-83133A | -31 | 6.7 | COLORLESS |
| *AVIATION (3) GASOLINE (ALL GRADES) | MIL-G-5572 AND ASTM-D910 | -54 | 6.0 | 80/87 RED, 100 GREEN, 100LL BLUE |

* Aviation gasoline (all grades) is approved for emergency use only. Refer to Section 2 for limitation requirements and Section 8 for fuel servicing information. A record of total aviation gasoline used must be recorded in Airplane Engine Maintenance Record.

NATO equivalents of the above fuels may be used.



●AVIATION GASOLINE IS RESTRICTED TO EMERGENCY USE AND SHALL NOT BE USED FOR MORE THAN 150 HOURS IN ONE OVERHAUL PERIOD.

●A MIXTURE OF ONE PART AVIATION GASOLINE AND THREE PARTS OF JET A, JET A-1, OR JP-5 MAY BE USED FOR EMERGENCY PURPOSES FOR A MAXIMUM OF 450 HOURS PER OVERHAUL PERIOD.

●AUXILIARY BOOST PUMP MUST BE ON WHEN USING AVIATION GASOLINE.

NOTE

Fuel used must contain an anti-icing additive in compliance with MIL-I-27686E. Refer to Section 8 for additional information.

Total fuel capacity (U.S. gallons): 481.5

Usable fuel (U.S. gallons): 475.0

OIL

Refer to Section 8 for list of approved oils and specifications.

Total Oil Capacity
(Per Engine): 9.2 U.S. Quarts

Drain and Refill
Quantity
(Per Engine): Approximately 8.4 U.S. Quarts including oil filter.

Oil Quantity
Operating Range: Fill to within 2 quarts of MAX HOT or MAX COLD (as appropriate) on dipstick. Quart markings indicate U.S. quarts low if oil is hot. For example, a dipstick reading of 3 indicates the system is within 2 quarts of MAX if oil is cold and within 3 quarts of MAX if the oil is hot.

NOTE

To obtain an accurate oil level reading, it is recommended the oil level be checked within 10 minutes after engine shutdown while the oil is hot (MAX HOT marking) or prior to the first flight of the day while the oil is cold (MAX COLD marking). If more than 10 minutes has elapsed since engine shutdown, and engine is still warm, perform an engine dry motoring run before checking oil level.

MAXIMUM CERTIFICATED WEIGHTS

Maximum Ramp Weight: 9435 Pounds

Maximum Takeoff Weight: 9360 Pounds

Maximum Landing Weight: 9360 Pounds

Maximum Zero Fuel
Weight With Zero
Wing Locker Payload: 8500 Pounds

Maximum Weights
in Baggage
Compartments
(Standard and
Optional Interior
Passenger
Configurations):

- a. Left and Right Wing Lockers - 200 pounds each.
- b. Avionics Bay - 250 pounds less installed optional equipment. Refer to the loading placard in the airplane avionics baggage bay.
- c. Nose Bay - 350 pounds less installed optional equipment. Refer to the loading placard in the airplane nose baggage bay.

- d. Aft Cabin (Bay A) Refer to Figure 1-3 - 400 pounds (200 pounds per side). Maximum floor loading is 75 pounds per square foot.
- e. Aft Cabin (Bay B) Refer to Figure 1-3 - 100 pounds (50 pounds per side). Maximum floor loading is 75 pounds per square foot.

**Maximum Weights
in Baggage
Compartments
(Cargo Interior
Configuration):**

- a. Left and Right Wing Lockers - 200 pounds each.
- b. Avionics Bay - 250 pounds less installed optional equipment. Refer to the loading placard in the airplane avionics baggage bay.
- c. Nose Bay - 350 pounds less installed optional equipment. Refer to the loading placard in the airplane nose baggage bay.
- d. Maximum cargo load in any 24-inch length of cabin floor is 600 pounds per bay in the five cargo bays (Cargo A,B,C,D, & E). If the cargo has a smooth, reasonable flat lower surface, load densities of up to 200 pounds per square foot may be loaded in the cargo bays. Use pallets or beams to distribute the loads over all seat rails if adjacent cargo bays are loaded at a rate of over 75 pounds per square foot.
- e. Aft Cabin (Bay A) - 400 pounds (200 pounds per side). Maximum floor loading is 75 pounds per square foot.
- f. Aft Cabin (Bay B) - 100 pounds (50 pounds per side). Maximum floor loading is 75 pounds per square foot.
- g. Refer to Section 7, Cargo loading, for additional information.

STANDARD AIRPLANE WEIGHTS

Standard Empty Weight: 5033 Pounds
(Standard interior)

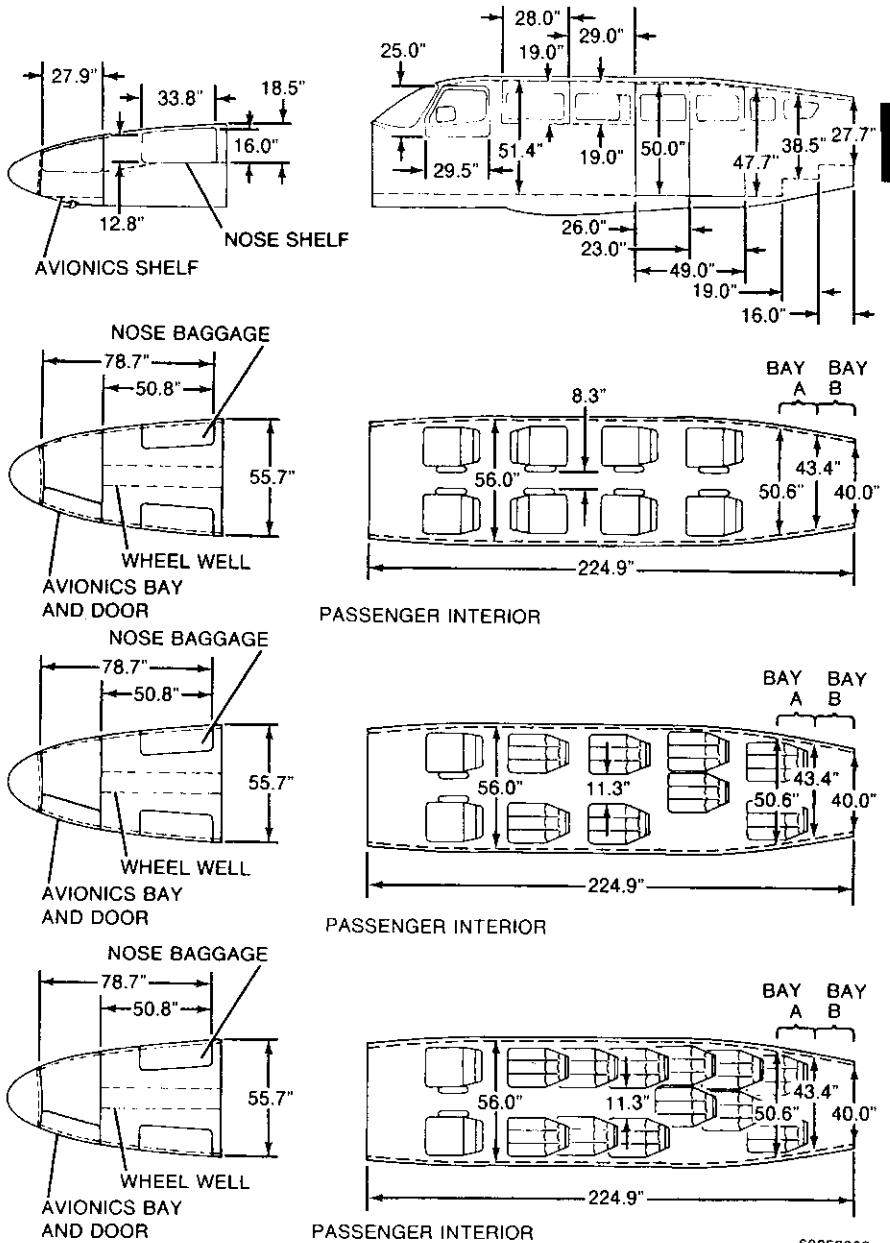
Basic Empty Weight: 5136 Pounds
(Optional interior with 8 seat
configuration and standard avionics)

Basic Empty Weight: 5160 Pounds
(Optional interior with 9 seat
configuration and standard avionics)

Basic Empty Weight: 5185 Pounds
(Optional interior with 10 seat
configuration and standard avionics)

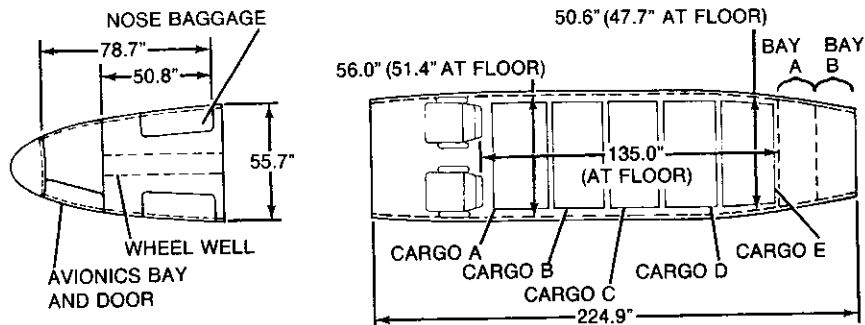
| | |
|--|--|
| Basic Empty Weight: (Optional interior with 11 seat configuration and standard avionics) | 5050 Pounds |
| Basic Empty Weight: (Optional interior with 12 seat configuration and standard avionics) | 5067 Pounds (28 inch spacing) 5061 Pounds (31 inch spacing) |
| Basic Empty Weight: (Optional interior with 14 seat configuration and standard avionics) | 5092 Pounds |
| Basic Empty Weight: (Cargo interior) | 4892 Pounds |
| Maximum Useful Load: (Standard interior)* | 4402 Pounds |
| Maximum Useful Load: (Optional interior with 8 seat configuration and standard avionics)* | 4299 Pounds |
| Maximum Useful Load: (Optional interior with 9 seat configuration and standard avionics)* | 4275 Pounds |
| Maximum Useful Load: (Optional interior with 10 seat configuration and standard avionics)* | 4250 Pounds |
| Maximum Useful Load: (Optional interior with 11 seat configuration and standard avionics)* | 4385 Pounds |
| Maximum Useful Load: (Optional interior with 12 seat configuration and standard avionics)* | 4368 Pounds (28 inch spacing) 4374 Pounds (31 inch spacing) |
| Maximum Useful Load: (Optional interior with 14 seat configuration and standard avionics)* | 4343 Pounds |
| Maximum Useful Load: (Cargo interior)* | 4543 Pounds |

*Based On Maximum Ramp Weight.

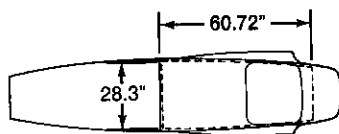


**Figure 1-2 (Sheet 1 of 2)
CABIN, BAGGAGE AND ENTRY DIMENSIONS**

60852002
60851002
60866036

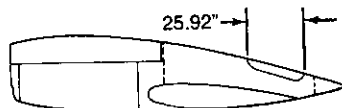


CARGO INTERIOR



BAGGAGE AND CARGO
COMPARTMENT VOLUME - CUBIC FEET

| | |
|-----------------------------|-------|
| AVIONICS BAY | 11.0 |
| NOSE | 15.0 |
| WING LOCKER EACH (STD) | 10.55 |
| AFT CABIN (BAY A AND B) | 31.7 |
| CABIN (CARGO A,B,C,D AND E) | 201.0 |



60852002
60851002
60851001

Figure 1-2 (Sheet 2 of 2)
CABIN, BAGGAGE AND ENTRY DIMENSIONS

SPECIFIC LOADINGS

Wing Loading: 37.03 pounds per square foot.

Power Loading: 9.36 pounds per horsepower.

SYMBOLS, ABBREVIATIONS AND TERMINOLOGY**GENERAL AIRSPEED TERMINOLOGY AND SYMBOLS**

| | |
|-------|---|
| CAS | Calibrated Airspeed means indicated speed of an airplane corrected for position and instrument error. Calibrated airspeed is equal to true airspeed in standard atmosphere at sea level. |
| G | Acceleration due to gravity. |
| GS | Ground Speed is the speed of an airplane relative to the ground. |
| IAS | Indicated Airspeed is the speed of an airplane as shown in the airspeed indicator when corrected for instrument error. IAS values published in this Handbook assume zero instrument error. |
| KCAS | Calibrated Airspeed expressed in knots. |
| KIAS | Indicated Airspeed expressed in knots. |
| KTAS | True Airspeed expressed in knots. |
| M | Mach Number is the ratio of true airspeed to the speed of sound. |
| NM | Distance expressed in Nautical Miles. |
| TAS | True Airspeed is the airspeed of an airplane relative to undisturbed air which is the CAS corrected for altitude, temperature and compressibility. |
| V_1 | Takeoff Decision Speed is the speed at which an engine failure or other cause is recognized, the distance to continue the takeoff to 50 feet or bring the airplane to a stop will not exceed the scheduled field length distance. The first action required to stop or continued is assumed to have been initiated by V_1 . |
| V_2 | Takeoff Safety Speed is the speed at 50 feet above the runway surface as demonstrated in flight during takeoff with one engine inoperative. |

- V_A Maneuvering Speed is the maximum speed at which application of full available aerodynamic control will not overstress the airplane.
- V_{EF} Critical Engine Failure Speed is the speed at which the engine was failed during certification flight testing to determine accelerated stop and accelerated go distances.
- V_{FE} Maximum Flap Extended Speed is the highest speed permissible with wing flaps in a prescribed extended position.
- V_{LE} Maximum Landing Gear Extended Speed is the maximum speed at which an airplane can be safely flown with the landing gear extended.
- V_{LO} Maximum Landing Gear Operating Speed is the maximum speed at which the landing gear can be safely extended or retracted.
- V_{MCA} Air Minimum Control Speed is the minimum flight speed at which the airplane is directionally and laterally controllable as determined in accordance with Federal Aviation Regulations. Airplane certification conditions include one engine becoming inoperative and feathered; not more than a 5-degree bank toward the operative engine; takeoff power on operative engine; landing gear up; flaps in takeoff position; and most critical center-of-gravity.
- V_{MO}/M_{MO} Maximum Operating Limit Speed is the speed limit that may not be deliberately exceeded in normal flight operations. V is expressed in knots and M in Mach Number.
- V_R Rotation Speed is the speed at which rotation is initiated during takeoff to attain the V_2 climb speed at or before a height of 50 feet above runway surface has been reached.
- V_S Stalling Speed or the minimum steady flight speed at which the airplane is controllable.
- V_{SO} Stalling Speed or the minimum steady flight speed at which the airplane is controllable in the landing configuration.

| | |
|-----------|---|
| V_{SSE} | Intentional One Engine Inoperative Speed is a minimum speed, selected by the manufacturer, for intentionally rendering one engine inoperative, in flight, for pilot training. |
| V_X | Best Angle-of-Climb Speed is the airspeed which delivers the greatest gain of altitude in the shortest possible horizontal distance. |
| V_{XSE} | One Engine Inoperative Best Angle-of-Climb Speed is the airspeed which delivers the greatest gain of altitude in the shortest possible horizontal distance. |
| V_Y | Best Rate-of-Climb Speed is the airspeed which delivers the greatest gain in altitude in the shortest possible time. |
| V_{YSE} | One Engine Inoperative Best Rate-of-Climb Speed is the airspeed which delivers the greatest gain in altitude in the shortest possible time. |

METEOROLOGICAL TERMINOLOGY

| | |
|-----------------------------|---|
| $^{\circ}C$ | Temperature expressed in degrees Celsius. |
| $^{\circ}F$ | Temperature expressed in degrees Fahrenheit. |
| Indicated Pressure Altitude | The number actually read from an altimeter when the barometric subscale has been set to 29.92 inches of mercury (1013.2 millibars). |
| IOAT | Indicated Outside Air Temperature is the temperature indicated on the pilot's outside air temperature indicator. The indication is not adjusted for instrument error or temperature compressibility effects. |
| ISA | International Standard Atmosphere in which: <ol style="list-style-type: none"> (1) The air is a dry perfect gas; (2) The temperature at sea level is 15 degrees Celsius; (3) The pressure at sea level is 29.92 inches Hg. (1013.2 millibars); (4) The temperature gradient from sea level to the altitude at which the temperature is -56.6 degrees Celsius, is -1.98 degrees Celsius per 1000 feet. |
| OAT | Outside Air Temperature is the free air static temperature, obtained either from inflight temperature indications or ground meteorological sources adjusted for instrument error and compressibility effects. |

| | |
|---|---|
| Pressure Altitude | Altitude measured from standard sea-level pressure (29.92 inches Hg.) by a pressure or barometric altimeter. It is the indicated pressure altitude corrected for position and instrument error. In this handbook, altimeter instrument errors are assumed to be zero. |
| Station Pressure | Actual atmospheric pressure at field elevation. |
| Temperature Compressibility Effects | An error in the indication of temperature caused by airflow over the temperature probe. The error varies, depending on altitude and airspeed. |
| Wind | The wind velocities recorded as variables on the charts of this handbook are to be understood as the headwind or tailwind components of the reported winds. |

POWER TERMINOLOGY

| | |
|--------------------------------|--|
| Auto Feather | A system designed to automatically reduce drag of an inoperative engine by moving the propeller to feather. |
| Critical Altitude | The maximum altitude at which in standard temperature it is possible to maintain a specified power. |
| Cruising Climb Power | The power recommended to operate the airplane in a cruise climb (a continuous gradual climb) profile. |
| ITT | Interturbine Temperature. |
| Flameout | Unintentional loss of combustion chamber flame during operation. |
| Flat Rated | Constant horsepower over a specific altitude range. |
| Flight Idle Power | The power required to run an engine, in flight, at the lowest speed that will ensure satisfactory engine operation and airplane handling characteristics. |
| Gas Generator RPM (N_g) | Indicates the percent of gas generator rpm based on a figure of 100 percent at 37,500 rpm. |
| Ground Idle Power | The power required to run an engine on the ground, as slowly as possible, yet sufficient to ensure satisfactory engine, engine accessory, and airplane operation with a minimum of thrust. |

| | |
|-----------------------------|--|
| Hot Start | An engine start, or attempted start, which results in ITT exceeding 1090 degrees Celsius. |
| Maximum Continuous Power | The power developed at the maximum continuous torque limit, ITT limit: or Ng limit. This is equivalent to takeoff power. |
| Maximum Cruise Power | The power developed at the maximum cruise torque limit, ITT limit or Ng limit. |
| Power Turbine RPM (N_t) | Indicates the percent of power turbine speed based on a figure of 100 percent at 33,000 rpm and a propeller speed (N_p) of 1900 rpm. |
| Propeller RPM (N_p). | Indicates propeller speed in rpm. |
| RPM | Revolutions Per Minute. |
| Reverse Thrust | The thrust produced when the propeller blades are rotated past flat pitch into the Beta range. |
| SHP | Shaft horsepower means the power delivered at the propeller shaft. |
| Takeoff Power | The maximum power permissible for takeoff. |
| Torque | A measurement that is proportional to the power output of the engine. |
| Windmill | Propeller rotation from airstream inputs. |

ENGINE CONTROLS AND INSTRUMENTS TERMINOLOGY

| | |
|------------------------|---|
| Beta Mode | Engine operational mode in which propeller blade pitch is controlled by the cockpit power lever. May be used during ground operations only. |
| Fuel Control Lever | Cockpit Control lever which sets the fuel control in either "RUN" or "CUTOFF". |
| Gas Generator Governor | Regulates the gas generator to the speed selected by the cockpit power lever. |
| ITT Gage | Interturbine temperature gage displaying air temperature between the compressor turbine and power turbine. |

| | |
|------------------------------|--|
| Overspeed Governor | Flyweight operated fuel metering device, housed in the propeller governor. It prevents engine overspeed in the event of a malfunction of the propeller governor. |
| Propeller Governor | Regulates the RPM of the propeller by increasing or decreasing the propeller pitch through a pitch change mechanism in the propeller hub. |
| Power Control Lever | Cockpit lever used to set gas generator speed. During Beta mode the power lever controls propeller blade angle and speed. |
| Propeller Lever | Cockpit lever used to set propeller RPM. |
| Propeller Overspeed Governor | A gearbox mounted governor which dumps propeller oil pressure to prevent engine damage should the propeller governor fail. |
| Tachometer | Indicates the speed of the gas generator (N_g) or propeller (N_p). |
| Torque Meter | The instrument that indicates the torque output of the engine gear box. |

AIRPLANE PERFORMANCE AND FLIGHT PLANNING TERMINOLOGY

| | |
|---------------------------------|---|
| Accelerate-Go Distance | The distance required to accelerate an airplane to V_1 and assuming pilot recognizes an engine failure at V_1 , continues takeoff on the remaining engine to a height of 50 feet. |
| Accelerate-Stop Distance | The distance required to accelerate an airplane to V_1 and assuming pilot recognizes an engine failure at V_1 , brings the airplane to a stop. |
| Aerobatic Maneuver | An intentional maneuver involving an abrupt change of an airplane's attitude, an abnormal attitude, or abnormal acceleration, not necessary for normal flight. |
| Balked Landing | A balked landing is an aborted landing (i.e., all engines go-around in the landing configuration). |
| Balked Landing Transition Speed | The minimum speed at which a transition to a balked landing climb should be attempted (from 50-foot obstacle height). |

| | |
|---------------------------------|---|
| Climb Gradient | The demonstrated ratio of the change in height during a portion of a climb to the horizontal distance traversed in the same time interval. |
| Demonstrated Crosswind Velocity | The demonstrated crosswind velocity is the velocity of the crosswind component for which adequate control of the airplane during takeoff and landing was actually demonstrated during certification tests. The value shown is not considered to be limiting. This value is not an aerodynamic limit for the airplane. |
| Maneuvering Fuel | Maneuvering fuel is the usable fuel as shown in Section 2 for all airplane configurations, provided the maximum side slip duration is not exceeded. |
| Maximum Effective Braking | The maximum amount of braking pressure that can be applied to the toe brakes without locking the wheels. |
| MEA | Minimum enroute IFR altitude. |
| Route Segment | A part of a route. Each end of that part is identified by: (1) a geographical location; or (2) a point at which a definite radio fix can be established. |

WEIGHT AND BALANCE TERMINOLOGY

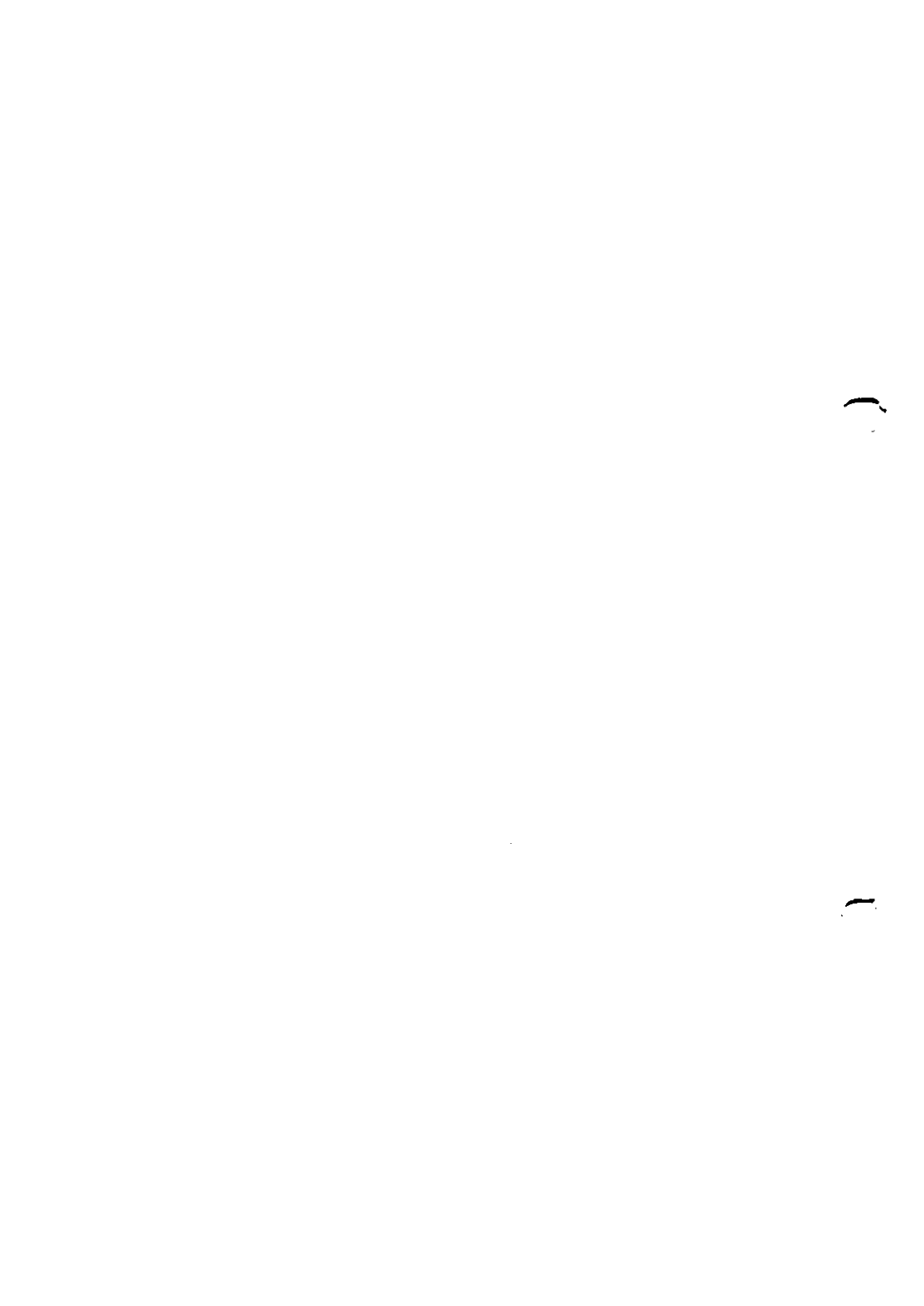
| | |
|--------------------|---|
| Arm | The horizontal distance from the reference datum to the center-of-gravity (C.G.) of an item. |
| Basic Empty Weight | Standard empty weight plus installed optional equipment. |
| Center-of-Gravity | The point at which an airplane would balance if suspended. Its distance from the reference datum is found by dividing the total moment by the total weight of the airplane. |
| C.G. Arm | The arm obtained by adding the airplane's individual moments and dividing the sum by the total weight. |
| C.G. Limits | The extreme center-of-gravity locations within which the airplane must be operated at a given weight. |
| Jack Point | One of the three points on the airplane designed to rest on a jack. |
| MAC | The Mean Aerodynamic Chord of a wing is the chord of an imaginary airfoil which throughout the flight range will have the same force vectors as those of the wing. |

| | |
|--------------------------|---|
| Maximum Landing Weight | Maximum weight approved for the landing touch-down. |
| Maximum Ramp Weight | Maximum weight approved for ground maneuver. (It includes weight of start, taxi and run-up fuel.) |
| Maximum Takeoff Weight | Maximum weight approved for the start of the takeoff run. |
| Maximum Zero Fuel Weight | Maximum weight exclusive of usable fuel. |
| Moment | The product of the weight of an item multiplied by its arm. (Moment divided by a constant is used to simplify balance calculations by reducing the number of digits.) |
| Payload | Weight of occupants, cargo and baggage. |
| Reference Datum | An imaginary vertical plane from which all horizontal distances are measured for balance purposes. |
| Residual Fuel | The undrainable fuel remaining when the airplane is defueled in a specific attitude by the normal means and procedures specified for draining the tanks. |
| Standard Empty Weight | Weight of a standard airplane including unusable fuel, full operating fluids and full oil. |
| Station | A location along the airplane fuselage given in terms of distance from the reference datum. |
| Tare | Tare is the weight of the chocks, blocks, stands, etc. used when weighing an airplane, and is included in the scale readings. Tare is deducted from the scale reading to obtain the actual (net) airplane weight. |
| Unusable Fuel | Fuel remaining after fuel runout tests have been completed in accordance with governmental regulations. |
| Usable Fuel | Fuel available for flight planning. |
| Useful Load | Difference between ramp weight and the basic empty weight. |

**SECTION 2
LIMITATIONS**

TABLE OF CONTENTS

| | Page |
|---|------|
| INTRODUCTION | 2-3 |
| AIRSPPEED LIMITATIONS | 2-4 |
| AIRSPPEED INDICATOR MARKINGS | 2-6 |
| POWERPLANT LIMITATIONS | 2-6 |
| POWERPLANT INSTRUMENT MARKINGS | 2-10 |
| MISCELLANEOUS INSTRUMENT MARKINGS | 2-11 |
| WEIGHT LIMITS | 2-11 |
| CENTER-OF-GRAVITY LIMITS | 2-13 |
| MANEUVER LIMITS | 2-13 |
| FLIGHT LOAD FACTOR LIMITS | 2-13 |
| FLIGHT CREW LIMITS | 2-13 |
| KINDS OF OPERATIONAL EQUIPMENT LIMITS | 2-13 |
| FUEL LIMITATIONS | 2-16 |
| MAXIMUM OPERATING ALTITUDE LIMIT | 2-16 |
| OUTSIDE AIR TEMPERATURE LIMITS | 2-16 |
| MAXIMUM PASSENGER SEATING LIMITS | 2-17 |
| PLACARDS | 2-18 |



INTRODUCTION

Section 2 presents the operating limitations, the significance of such limitations, instrument markings, color coding and basic placards necessary for the safe operation of the airplane, its powerplants, standard systems and standard equipment. The limitations included in this section and Section 9 are approved by the Federal Aviation Administration. Observance of these operating limitations is required by Federal Aviation Regulations.

Operation in countries other than the United States may require observance of other limitations, procedures or performance data in applicable supplements.

NOTE

●Refer to Section 9 for amended limitations for airplanes equipped with specific optional systems.

●The airspeeds listed in the Airspeed Limitations chart (Figure 2-1) and Airspeed Indicator Markings chart (Figure 2-3) are based on Airspeed Calibration data shown in Section 5.

AIRSPEED LIMITATIONS

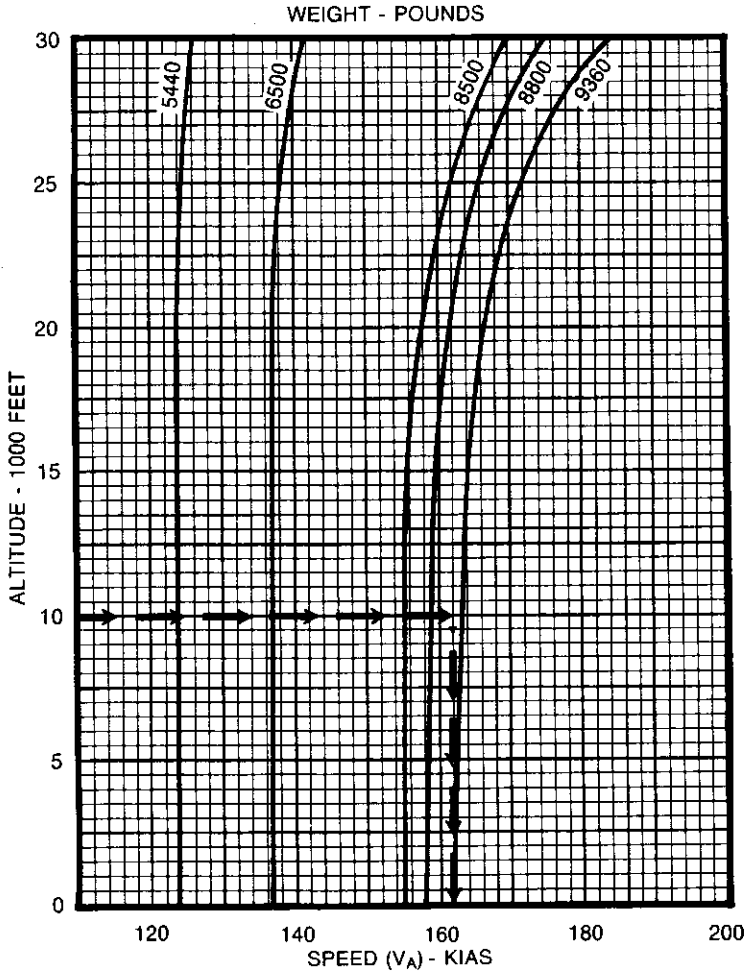
Airspeed limitations and their operational significance are shown in Figure 2-1.

| SPEED | CAS | IAS | REMARKS |
|---|-------------|-------------|---|
| MANEUVERING SPEED 9360 POUNDS AT SEA LEVEL (REFER TO FIGURE 2-2) V_A (KNOTS) | 163 | 162 | DO NOT MAKE ABRUPT CONTROL MOVEMENTS ABOVE THIS SPEED. |
| MAXIMUM FLAP EXTENDED SPEED T.O. AND APPR POSITIONS LAND POSITIONS V_{FE} (KNOTS) | 200 180 | 200 180 | DO NOT EXCEED THIS SPEED WITH THE GIVEN FLAP SETTING. |
| MAXIMUM GEAR OPERATING SPEED V_{LO} (KNOTS) | 180 | 180 | DO NOT EXTEND OR RETRACT LANDING GEAR ABOVE THIS SPEED. |
| MAXIMUM GEAR EXTENDED SPEED V_{LE} (KNOTS) | 180 | 180 | DO NOT EXCEED THIS SPEED WITH LANDING GEAR EXTENDED. |
| AIR MINIMUM CONTROL SPEED WITH WING FLAPS - T.O. V_{MCA} (KNOTS) NOTE <i>Buffet can be encountered as high as 95 KIAS with airplane at maximum takeoff weight and the wing flaps in the UP position. Flaps UP takeoff is not approved.</i> | 91 | 90 | THIS IS THE MINIMUM FLIGHT SPEED AT WHICH THE AIRPLANE IS CONTROLLABLE WITH ONE ENGINE INOPERATIVE AND A 5 DEGREES BANK TOWARDS THE OPERATIVE ENGINE. |
| MAXIMUM OPERATING LIMIT SPEED V_{MO} (KNOTS) M_{MO} (MACH NUMBER) | 230 0.52 | 229 0.52 | DO NOT EXCEED THIS SPEED OR MACH NUMBER IN ANY OPERATION. AS INDICATED BY BARBER POLE (RED AND WHITE NEEDLE) ON AIRSPEED INDICATOR. |

Figure 2-1
AIRSPEED LIMITATIONS

CONDITIONS:

- 1. Landing gear - UP
- 2. Wing flaps - UP



EXAMPLE:

Weight - 9000 Pounds
Altitude - 10,000 Feet

Maximum Maneuvering Speed - 162 KIAS

60856017

**Figure 2-2
MAXIMUM MANEUVERING SPEEDS**

AIRSPPEED INDICATOR MARKINGS

Airspeed indicator marking and their color significance are shown in Figure 2-3.

| MARKING | IAS VALUE OR RANGE | SIGNIFICANCE |
|------------------------------|---------------------------|---|
| RED RADIAL | 90 KNOTS | AIR MINIMUM CONTROL SPEED WITH WING FLAPS IN THE T.O. POSITION. |
| WHITE ARC | 75 TO 180 | OPERATING SPEED RANGE WITH WING FLAPS IN LAND POSITION. LOWER LIMIT IS MAXIMUM WEIGHT STALLING SPEED IN LANDING CONFIGURATION. UPPER LIMIT IS MAXIMUM SPEED PERMISSIBLE WITH FLAPS IN LAND POSITION. |
| WIDE NARROW | 75 TO 94.5 94.5 TO 180 | THE TRANSITION POINT FROM WIDE TO NARROW ARC IS THE STALL SPEED WITH WING FLAPS IN UP POSITION. |
| BLUE ARC | 104 TO 108 KNOTS | OPERATING SPEED RANGE WITH ONE ENGINE INOPERATIVE BEST RATE-OF-CLIMB SPEED, STANDARD DAY CONDITIONS AND MAXIMUM GROSS WEIGHT. LOWER LIMIT IS SPEED AT 15,000 FEET. UPPER LIMIT IS SPEED AT SEA LEVEL. |
| RED AND WHITE BARBER POLE | 229 KNOTS 0.52 MACH | MAXIMUM OPERATING SPEED. BARBER POLE INDICATES 229 KIAS UNTIL REACHING APPROXIMATELY 22,000 FEET. ABOVE THIS ALTITUDE, IT WILL INDICATE CONSTANT 0.52 MACH. |

Figure 2-3.
AIRSPPEED INDICATOR MARKINGS

POWERPLANT LIMITATIONS

Number of Engines: 2

Engine Manufacturer: Pratt and Whitney Canada Inc.

Engine Model Number: PT6A-112

Engine Operating Limits: Refer to Figure 2-4.

Starting Cycle Limitations:

- a. External Power Or Battery Start
 - 30 seconds On 60 seconds Off,
 - 30 seconds On 60 seconds Off,
 - 30 seconds On 30 minutes Off. Repeat the above cycle as required.

Minimum Engine Torque For Takeoff:

Refer to Figure 5-10 for minimum value for which takeoff performance can be obtained.

| POWER SETTING | ENGINE OPERATING LIMITS | | | | | |
|--------------------------------------|-------------------------|------------------------------|--|------------------------------------|--------------------------------|---------------------------------|
| | TORQUE FT-LBS (1) | MAXIMUM OBSERVED ITT°C | GAS GENERATOR RPM N _g % (2) | PROPELLER RPM N _p | OIL PRESSURE PSIG (3) | OIL TEMPERATURE °C (7) |
| TAKEOFF AND MAXIMUM CONTINUOUS | 1382 | 725 | 101.6 | 1900 | 80 to 100 | 10 to 99 |
| MAXIMUM CLIMB/ CRUISE (8) | 1382 1477(4) | 695 | 101.6 | 1900 1600 (4) | 80 to 100 | 10 to 99 |
| IDLE | | 685 | | | 40 MIN. | -40 to 99 |
| MAXIMUM REVERSE (5) | 1382 | 725 | 101.6 | 1815 | 80 to 100 | 0 to 99 |
| ACCELERATION (6) | 1900 | 825 | 102.6 | 2090 | | 0 to 99 |
| STARTING | | 1090 (6) | | | | -40 MIN. |

- (1) Maximum permissible sustained torque is 1477 foot-pounds. N_p must be set so as not to exceed engine operating limitations. Refer to PLACARDS this section for maximum torque table.
- (2) For every 10 degrees Celsius (18 degrees Fahrenheit) below -30 degrees Celsius (-22 degrees Fahrenheit) ambient temperature, reduce maximum allowable N_g by 2.2 percent.
- (3) Normal oil pressure is 80 to 100 PSIG at gas generator speeds above 27,000 RPM (72 percent) with oil temperature between 60 to 70 degrees Celsius (140 to 158 degrees Fahrenheit). Oil pressures below 80 PSIG are undesirable and should be tolerated only for the completion of the flight, preferably at reduced power setting. Oil pressures below normal should be reported as an engine discrepancy and should be corrected before next flight. Oil pressures below 40 PSIG are unsafe and require that either the engine be shut down or a landing be made as soon as possible using the minimum power required to sustain flight.
- (4) If maximum torque is used, N_p must be set so as not to exceed engine operating limitations.
- (5) Reverse power operation is limited to one minute.
- (6) These values are time limited to two seconds.
- (7) For increased oil service life, an oil temperature between 74 to 80 degrees Celsius (165 to 176 degrees Fahrenheit) is recommended. A minimum oil temperature of 55 degrees Celsius (130 degrees Fahrenheit) is recommended for fuel heater operation at takeoff power.
- (8) Maximum cruise power limits vary with altitude and temperature. For maximum cruise power limits refer to MAXIMUM CRUISE POWER tables in Section 5.

NOTE

100 percent N_g (2) is 37,500 RPM

**Figure 2-4
ENGINE OPERATING LIMITS**

Fuel Specification and Approved Fuel Additives:

| FUEL GRADE (2) | FUEL SPECIFICATIONS | MINIMUM FUEL TEMPERATURE FOR TAKEOFF - °C (1) | SPECIFIC WEIGHT - POUNDS PER U.S. GALLON AT 60°F | COLOR |
|---|-----------------------------|---|--|--|
| JET A | ASTM-D1655 | -31 | 6.7 | COLORLESS |
| JET A-1 | ASTM-D1655 | -31 | 6.7 | COLORLESS |
| JET B | ASTM-D1655 | -54 | 6.7 | COLORLESS |
| JP-1 | MIL-L-5616 | -54 | 6.7 | COLORLESS |
| JP-4 | MIL-T-5624 | -54 | 6.5 | COLORLESS |
| JP-5 | MIL-T-5624 | -31 | 6.8 | COLORLESS |
| JP-8 | MIL-T-83133A | -31 | 6.7 | COLORLESS |
| *AVIATION (3) GASOLINE (ALL GRADES) | MIL-G-5572 AND ASTM-D910 | -54 | 6.0 | 80/87 RED, 100 GREEN, 100LL BLUE |

* Aviation gasoline (all grades) is approved for emergency use only. A record of total aviation gasoline used must be recorded in the Airplane Engine Maintenance Record.

- (1) Minimum starting temperature is that given or the minimum allowable oil temperature, -40 degrees Celsius (-40 degrees Fahrenheit) whichever is warmer.
- (2) Refer to Section 8 for fuel servicing information.

CAUTION

● *AVIATION GASOLINE IS RESTRICTED TO EMERGENCY USE AND SHALL NOT BE USED FOR MORE THAN 150 HOURS IN ONE OVERHAUL PERIOD.*

● *A MIXTURE OF ONE PART AVIATION GASOLINE AND THREE PARTS OF JET A, JET A-1, JP-1, or JP-5 MAY BE USED FOR EMERGENCY PURPOSES FOR A MAXIMUM OF 450 HOURS PER OVERHAUL PERIOD.*

● *AUXILIARY BOOST PUMP MUST BE ON WHEN USING AVIATION GASOLINE.*

- (3) When using aviation gasoline the maximum fuel and ambient temperature for takeoff is 32 degrees Celsius (90 degrees Fahrenheit).
 - a. NATO equivalents of the above fuels may be used.
 - b. Fuel used must contain anti-icing fuel additive in compliance with MIL-I-27686E.

Fuel Additive:

The fuel used in the airplane must have an anti-icing additive in compliance with MIL-I-27686E, incorporated or added into the fuel during refueling.

CAUTION

JP-4 AND JP-5 FUELS PER MIL-T-5624 AND JP-8 FUEL PER MIL-T-83133A CONTAIN THE CORRECT PREMIXED QUANTITY OF AN APPROVED TYPE OF ANTI-ICING FUEL ADDITIVE AND NO ADDITIONAL ANTI-ICE COMPOUNDS SHOULD BE ADDED.

Ethylene glycol monomethyl ether (EGME) compound in compliance with MIL-I-27686E, if added, must be carefully mixed with the fuel in the tank in concentrations not to exceed 0.15 percent by volume. The minimum EGME concentration within the fuel tank is 0.035 percent by volume. The minimum EGME concentration for fuel being added to the fuel tank is 0.060 percent by volume.

WARNING

REFER TO SECTION 8 FOR PROPER HANDLING AND SERVICING OF EGME.

CAUTION

MIXING OF THE EGME COMPOUND WITH THE FUEL IS EXTREMELY IMPORTANT BECAUSE CONCENTRATION IN EXCESS OF THAT RECOMMENDED (0.15 PERCENT BY VOLUME MAXIMUM) WILL RESULT IN DETRIMENTAL EFFECTS TO THE FUEL TANKS, SUCH AS DETERIORATION OF PROTECTIVE PRIMER AND SEALANTS AND DAMAGE TO O-RINGS AND SEALS IN THE FUEL SYSTEM AND ENGINE COMPONENTS. USE ONLY BLENDING EQUIPMENT THAT IS RECOMMENDED BY THE MANUFACTURER TO OBTAIN PROPER PROPORTIONING.

Preflight Checks:

- a. The overspeed governor check shall be performed: before the first flight of the day, if there is an indication of malfunction, after engine control system maintenance, or if adjustment has been made.
- b. Autofeather shall be checked before each flight and must be operative for takeoff.

Oil Specification:

- a. Refer to Section 8 for list of approved oils and specifications.
- b. When adding oil, service the engines with the type and brand which is currently being used in the engines. Do not mix types or brands of oils.
- c. Type II oils in compliance with Pratt and Whitney Canada Inc. Specification PWA 521.
- d. Oil conforming to Pratt and Whitney Canada Inc., Service Bulletin Number 12001 and all revisions or supplements thereto, must be used.

Propellers:

- a. Number of Propellers: 2
- b. Manufacturer: McCauley Accessory Division of Cessna Aircraft Company.
- c. Cessna Part Number: 9910535-2
- d. Number of Blades: 3
- e. Diameter: 7.75 Feet
- f. Maximum Operating Speed: 1900 RPM
- g. Blade Angle: (At 30-Inch Station)
 - (1) Feathered 85.5 degrees
 - (2) Low Pitch 18.5 degrees
 - (3) Full Reverse -13.5 degrees
- h. Flight operation with power levers retarded below FLIGHT IDLE are prohibited.

POWERPLANT INSTRUMENT MARKINGS

Torque Indicators:

- a. 1382 Foot-Pounds Maximum Takeoff And Climb Torque At 1900 RPM (Yellow Radial)
- b. 0 to 1477 Foot-Pounds (Green Arc)
- c. 1477 Foot-Pounds Maximum Cruise Torque At 1600 RPM (Red Radial)

ITT Indicators:

- a. 725 degrees Celsius (Red Line)
- b. 0 degrees to 695 degrees Celsius (Green Arc)
- c. 695 degrees to 1090 degrees Celsius (Yellow Arc)
- d. 1090 degrees Celsius (Red Triangle)

Gas Generator RPM Indicators:

- a. 101.6 percent RPM (Red Line)
- b. 52 percent to 101.6 percent RPM (Green Arc)

Propeller RPM Indicators:

- a. 1900 RPM (Red Line)
- b. 1600 to 1900 RPM (Green Arc)

Oil Pressure Indicators:

- a. 40 and 100 PSI (Red Radial)
- b. 40 to 80 PSI (Yellow Arc)
- c. 80 to 100 PSI (Green Arc)

Oil Temperature Indicators:

- a. -40 degrees and +99 degrees Celsius (Red Radial)
- b. +10 degrees to +99 degrees Celsius (Green Arc)
- c. -40 degrees to +10 degrees Celsius (Yellow Arc)

MISCELLANEOUS INSTRUMENT MARKINGS**Instrument Air:**

- a. Red Line: 2.25 PSI
- b. Green Arc: 2.25 to 2.75 PSI

Oxygen Pressure:

- a. Yellow Arc: 0 to 300 PSI
- b. Green Arc: 1550 to 1850 PSI
- c. Red Line: 2000 PSI

Propeller Deice Ammeter:

- a. Individual indicators will be marked LEFT or RIGHT.
- b. White arc operating range will be marked with the high end of the scale marked with HI.
- c. A normal operating green arc will be provided between the HI and LOW ends of the white arc operating range.

WEIGHT LIMITS

Maximum Ramp Weight: 9435 Pounds

Maximum Takeoff Weight:

The takeoff weight is limited by the most restrictive of the following requirements:

- a. Maximum Takeoff Weight: 9360 Pounds.
- b. Maximum takeoff weight to achieve takeoff climb requirements from Figure 5-11.
- c. Maximum takeoff weight as permitted by field length from Figure 5-12.

- d. Maximum takeoff weight as permitted by the demonstrated brake energy limits from Figure 5-13.

Maximum Landing Weight:

The landing weight is limited by the most restrictive of the following requirements:

- a. Maximum Landing Weight: 9360 Pounds.
- b. Landing field length required from Figure 5-35.

Maximum Zero Fuel Weight with Zero Wing

Locker Payload: 8500 Pounds

Maximum Weights In Baggage Compartments:

(Standard and Optional Passenger Interior Configurations)

- a. Left and Right Wing Lockers - 200 pounds each.
- b. Avionics Bay - 250 pounds less installed optional equipment.
- c. Nose Bay - 350 pounds less installed optional equipment.
- d. Aft Cabin (Bay A) - 400 pounds (200 Pounds Per Side). Maximum floor loading is 75 pounds per square foot.
- e. Aft Cabin (Bay B) - 100 pounds (50 Pounds Per Side). Maximum floor loading is 75 pounds per square foot.

Maximum Weights in Baggage Compartments (Cargo Interior)

- a. Left and Right Wing Lockers - 200 pounds each.
- b. Avionics Bay - 250 pounds less installed optional equipment.
- c. Nose Bay - 350 pounds less installed optional equipment.
- d. Maximum cargo load in any 24-inch length of cabin floor is 600 pounds per bay in the five cargo bays (Cargo A, B, C, D and E). If the cargo has a smooth, reasonable flat lower surface, load densities of up to 200 pounds per square foot may be loaded in the cargo bays. Use pallets or beams to distribute the loads over all seat rails if adjacent cargo bays are loaded at a rate of over 75 pounds per square foot.
- e. Aft Cabin (Bay A) - 400 pounds (200 Pounds Per Side). Maximum floor loading is 75 pounds per square foot.
- f. Aft Cabin (Bay B) - 100 pounds (50 Pounds Per Side). Maximum floor loading is 75 pounds per square foot.

CENTER-OF-GRAVITY LIMITS (GEAR EXTENDED)

- a. Aft Limit: 180.28 inches aft of reference datum (32.00% MAC) at 9435 pounds or less.
- b. Forward Limit: 172.42 inches aft of reference datum (19.58% MAC) at 9360 pounds or less and 166.99 inches aft of reference datum (11.00% MAC) at 6500 pounds or less with straight line variation between these points.
- c. Refer to Section 6 for loading schedule. The reference datum is 100 inches forward of the aft face of the fuselage bulkhead forward of the rudder pedals. The mean aerodynamic chord (MAC) is 63.245 inches in length. The leading edge of the MAC is 160.04 inches aft of the reference datum.

MANEUVER LIMITS

This is a normal category airplane. Aerobatic maneuvers, including spins, are prohibited.

FLIGHT LOAD FACTOR LIMITS

Inflight:

- a. Wing Flaps - UP: -1.44 to +3.6 G at Maximum Gross Weight.
- b. Wing Flaps - TAKEOFF thru LAND positions, 0.0 to +2.0 G at Maximum Gross Weight.

FLIGHT CREW LIMITS

Minimum flight crew is one pilot with the required equipment installed and operational.

KINDS OF OPERATIONAL EQUIPMENT LIMITS

This airplane is equipped for day VFR, night VFR, and day and night IFR operations. The operating limitations placard reflects the limits applicable at the time of Airworthiness Certificate issuance.

The following equipment lists identify the systems and equipment upon which type certification for each kind of operation was predicated. These systems and equipment items must be installed and operable for the particular kind of operation indicated unless an FAA Approved Minimum Equipment List is in effect. The pilot is responsible for determining the airworthiness of his airplane for each flight and for assuring compliance with current operating regulations. The number in () indicates more than one required per airplane.

DAY VFR:

1. Pilot Instruments
 - a. Airspeed Indicator (Sensitive)
 - *b. Altimeter Indicator
 - c. Magnetic Direction Indicator
2. Annunciators (Lights)
 - a. Oil Pressure (2)
 - b. Wing Overheat (2)
 - c. Fuel Pressure Low (2)
 - d. Auxiliary Boost Pump On (2)
 - e. Battery Overheat
 - f. Hydraulic Pressure On
 - g. Autofeather Arm (2)
 - h. Air Duct Overheat
 - i. Landing Gear Position Indicator
 - j. Fuel Filter Bypass (2)
 - k. Inertial Separator (2)
 - l. Fuel Transfer Pump (2)
3. Engine Instruments
 - a. Torque Indicator (2)
 - b. Propeller Tachometer (2)
 - c. ITT Indicator (2)
 - d. Gas Generator Tachometer (N_g) (2)
 - e. Oil Pressure Gage (2)
 - f. Oil Temperature Gage (2)
4. Miscellaneous Indicators
 - a. Fuel Quantity Gage (2)
 - b. Voltmeter
 - c. Ammeter (2)
 - d. Outside Air Temperature Gage
5. Systems
 - a. Auxiliary Boost Pump (2)
 - b. Firewall Shutoff (2)
 - c. Generator (2)
 - d. Inertial Separator (2)
 - e. Stall Warning
 - f. Aileron Trim
 - g. Rudder Trim

* When a servoed altimeter is installed a functioning pneumatic altimeter is also required.

- h. Elevator Trim (Manual Only)
- i. Engine Ignition (2)
- j. Engine Fire Detection (2)
- k. Hydraulic Pumps(2)
- l. Flap
- m. Overspeed Governor (2)
- n. Autofeather (2)
- 6. Miscellaneous Items
 - a. Seat Belts (Each Occupant)
 - b. Shoulder Harnesses (Front Seat(s))
 - c. Pilot's Operating Handbook and FAA Approved Airplane Flight Manual
 - d. Pilot's Abbreviated Checklist (Single Pilot Operation Only)
 - e. Headset and Boom Mounted Microphone (Single Pilot Operation Only)
 - f. Exit Sign (3)

NIGHT VFR:

- 1. All Equipment Required for DAY VFR
- 2. Instrument Lights (As Required)
- 3. Navigation Lights (3)
- 4. Strobe Lights (2)

IFR:

- 1. All Equipment Required for DAY VFR
- 2. All Equipment Required for NIGHT VFR (If a Night Flight)
- 3. Pilot's Instruments
 - a. Attitude Indicator (Gyro Stabilized)
 - b. Directional Indicator (Gyro Stabilized)
 - c. Turn and Bank Indicator
 - d. Clock
- 4. Copilot's Instruments
 - a. Altimeter (Sensitive)
 - b. Vertical Speed Indicator (VSI)
 - c. Attitude Indicator (ADI)
 - d. Airspeed Indicator
 - e. Directional Gyro (DG)
- 5. Radios
 - a. Communication Radio
 - b. Navigation Radio (As Required)
- 6. Miscellaneous Indicator
 - a. Instrument Air Pressure Gage.

FUEL LIMITATIONS (Refer to Figure 2-5)

Maneuvering Fuel:

- a. Due to possible fuel starvation, maximum side slip duration time is one minute when the L or R XFER PUMP FAIL light is illuminated. The airplane is considered in a side slip any time the turn and bank "ball" is more than one-half ball out of the center (coordinated flight) position. Unusable fuel quantity increases when more severe side slip is maintained.

FUEL TABLE

| TOTAL FUEL CAPACITY (U.S. GALLONS) | USABLE FUEL (U.S. GALLONS) |
|---------------------------------------|-------------------------------|
| 481.5 | 475.0 |

Figure 2-5

Fuel Balance:

- a. Maximum fuel imbalance is 300 pounds.

Unusable Fuel:

- a. Unusable fuel is 3.25 gallons per side.

MAXIMUM OPERATING ALTITUDE LIMIT

Maximum Operating Altitude is 30,000 Feet.

OUTSIDE AIR TEMPERATURE LIMITS

Cold Day:

- a. -54 degrees Celsius (-65 degrees Fahrenheit) from Sea Level to 25,300 feet, then straight lined to 30,000 feet at -63 degrees Celsius (-81 degrees Fahrenheit) Refer to Section 5, ISA Conversion and Operating Temperature Limits Charts.

Hot Day:

- a. +53.0 degrees Celsius (+127 degrees Fahrenheit) for ground operations to 5000 feet.
- b. ISA +37.0 degrees Celsius (+99 degrees Fahrenheit) for all ground operations from 5000 feet to 14,000 feet.
- c. ISA +37.0 degrees Celsius (+99 degrees Fahrenheit) for all flight operations from sea level to 30,000 feet.

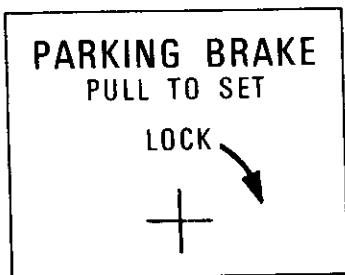
MAXIMUM PASSENGER SEATING LIMITS

The two forward seats are pilot seats.

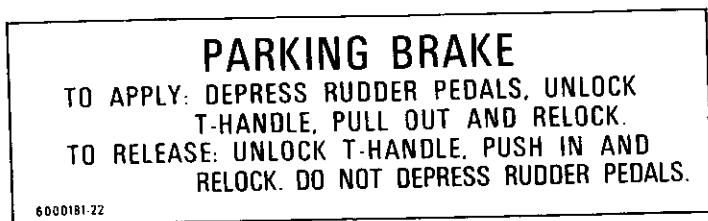
A maximum of 12 passenger seats may be installed aft of the pilot seats. Refer to Section 6 for seat locations.

PLACARDS

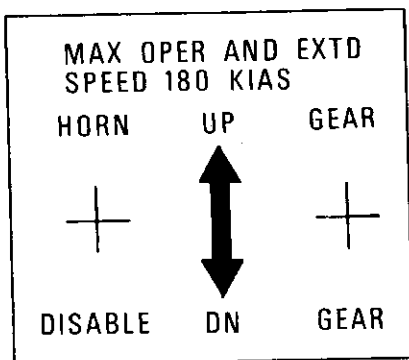
On Instrument Panel.



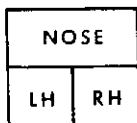
On Left Side Panel



On Instrument Panel Near Landing Gear Selector Switches:

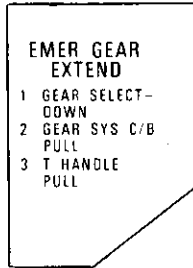


On Landing Gear Indicator Lights:

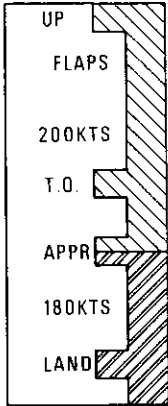


00116001

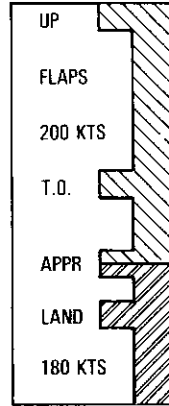
On Emergency Gear Control Cover.



Adjacent to Wing Flap Position Control.

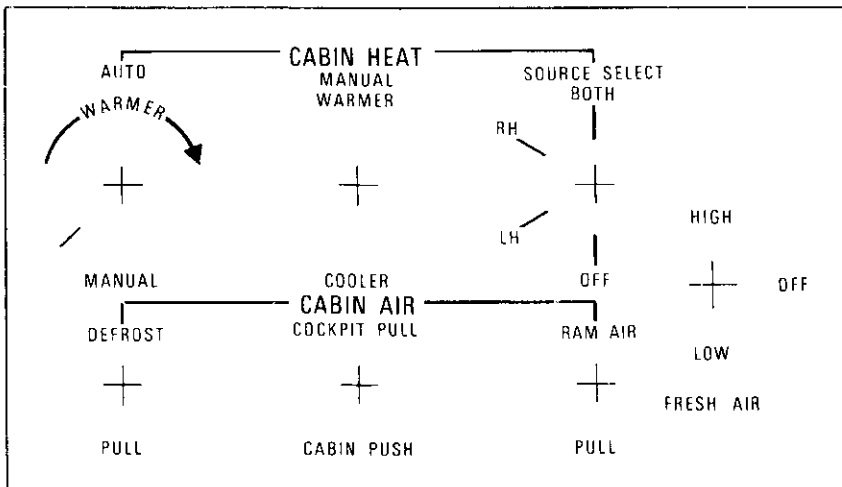


Airplanes -0001 thru -0010



Airplanes -0011 and On

On Environmental Control Panel.



On Left and Right Emergency Exit Window Trim.
Internal:

| | |
|----------|--|
| TO OPEN | 1. ROTATE RED HANDLE UP 2. PUSH WINDOW DOWN |
| TO CLOSE | 1. ROTATE RED HANDLE UP 2. RELEASE WINDOW STOP 3. CLOSE WINDOW FIRING 4. ROTATE HANDLE DOWN |

On Right Wall Forward of Emergency Exit and On Left Emergency Exit Window Trim.

AFT FACING SEAT BACK MUST BE
ERECT FOR TAKEOFF & LANDING

On Emergency Exits.
Internal:



Near Cabin Door
Exterior:



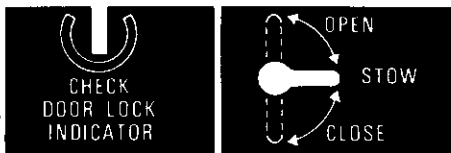
| |
|-----------------------------------|
| TO OPEN DOOR |
| ROTATE HANDLE DOWN |
| DEPLOY UPPER DOOR |
| ROTATE SILL LEVER UP |
| STAND CLEAR AND DEPLOY LOWER DOOR |
| TO CLOSE DOOR |
| STOW LOWER DOOR |
| ROTATE SILL LEVER DOWN TO LOCK |
| STOW UPPER DOOR |
| ROTATE HANDLE UP TO LOCK |
| STOW HANDLE |

00116001

**Near Cabin Door.
Internal:**

EXIT

TO OPEN DOOR
UNSTOW HANDLE
ROTATE HANDLE UP
DEPLOY UPPER DOOR
ROTATE SILL LEVER UP
DEPLOY LOWER DOOR
TO CLOSE DOOR
STOW LOWER DOOR
ROTATE SILL LEVER DOWN TO LOCK
STOW UPPER DOOR
ROTATE HANDLE DOWN TO LOCK
STOW HANDLE
CHECK DOOR LOCK INDICATOR



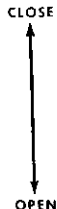
**Near Cargo Door.
Exterior:**

**CHECK
DOOR LOCK
INDICATOR**

**Near Left and Right Emergency Exits.
Exterior:**

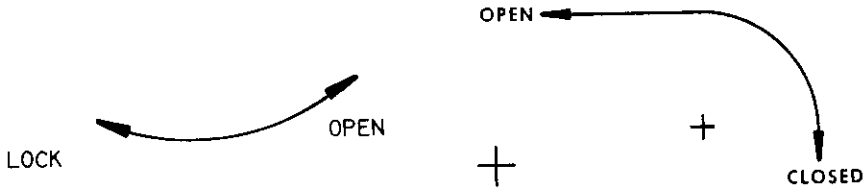


**Near Crew Door.
Exterior:**



00118001

Near Crew Door.
Internal:



| EMERGENCY EXIT/ CREW DOOR | |
|------------------------------|--|
| TO OPEN | <ol style="list-style-type: none">1. ROTATE SAFETY LOCK TO OPEN2. ROTATE 'D' HANDLE TO OPEN3. PUSH WINDOW OUT |
| TO CLOSE | <ol style="list-style-type: none">1. RELEASE WINDOW STOP2. CLOSE WINDOW FIRMLY3. ROTATE 'D' HANDLE TO CLOSED4. ROTATE SAFETY LOCK TO LOCK |

Near Cargo Door.
Internal:

CHECK
DOOR LOCK
INDICATOR

**DOOR
OPERATION**

TO OPEN:
SLIDE BUTTON
FWD → &
ROTATE
HANDLE ↻

TO CLOSE:
ROTATE
HANDLE ↻

FLIGHT WITH CARGO
DOOR OPENED OR
REMOVED IS PROHIBITED

00116001

On Horizontal Part of Lower Baggage Shelf.

**DO NOT USE SEAT
TRACKS ON THIS SHELF
FOR CARGO TIE-DOWN**

**FLOOR LOADING LIMITATIONS
400 POUNDS MAX THIS SHELF
(200 LBS/SIDE, 75 LBS/SQ FT)**

FOR AIRPLANE LOADING SEE
WEIGHT & BALANCE DATA IN
PILOT'S OPERATING HANDBOOK

On Horizontal Part of Upper Baggage Shelf.

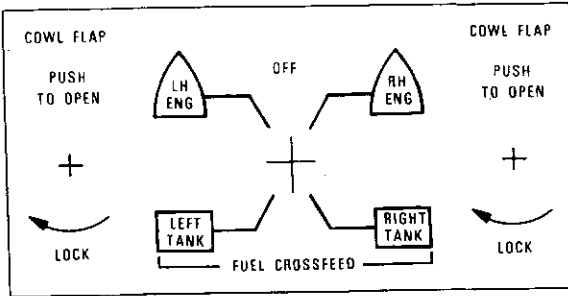
**FLOOR LOADING LIMITATIONS
100 POUNDS MAX THIS SHELF
(50 LBS/SIDE, 75 LBS/SQ FT)**

FOR AIRPLANE LOADING SEE
WEIGHT & BALANCE DATA IN
PILOT'S OPERATING HANDBOOK

On Cover of External Power Receptacle.

**EXTERNAL POWER
28 VOLTS D.C. NOMINAL
800 AMP
STARTING CAPACITY MIN.
DO NOT EXCEED 1700 AMPS**

On Control Pedestal.



On Pilot's Sunvisor (Forward Side).

OPERATIONAL LIMITS ON REVERSE SIDE

On Pilot's Sunvisor (Aft Side).

OPERATIONAL LIMITS

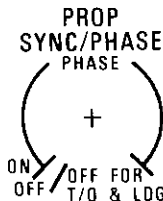
THE MARKINGS AND PLACARDS INSTALLED IN THIS AIRPLANE CONTAIN OPERATING LIMITATIONS WHICH MUST BE COMPLIED WITH WHEN OPERATING THIS AIRPLANE IN THE NORMAL CATEGORY. OTHER OPERATING LIMITATIONS WHICH MUST BE COMPLIED WITH WHEN OPERATING THIS AIRPLANE IN THE NORMAL CATEGORY ARE CONTAINED IN THE "PILOT'S OPERATING HANDBOOK AND FAA APPROVED AIRPLANE FLIGHT MANUAL."

THIS AIRPLANE IS APPROVED FOR DAY-NIGHT VFR CONDITIONS. IT IS APPROVED FOR DAY-NIGHT IFR CONDITIONS AND FLIGHTS INTO ICING CONDITIONS IF THE PROPER EQUIPMENT IS INSTALLED AND OPERATIONAL. NO AEROBATIC MANEUVERS, INCLUDING SPINS, APPROVED.

| | |
|--|-------------|
| MAXIMUM OPERATING ALTITUDE..... | 30,000 FEET |
| AIR MINIMUM CONTROL SPEED..... | 90 KIAS |
| MAXIMUM GEAR OPERATING SPEED..... | 180 KIAS |
| MAXIMUM GEAR EXTENDED SPEED..... | 180 KIAS |
| MAXIMUM FLAP EXTENDED SPEED T.O. & APPR..... | 200 KIAS |
| MAXIMUM FLAP EXTENDED SPEED LAND..... | 180 KIAS |
| MANEUVERING SPEED..... | 162 KIAS |

6000181-31

Near Propeller Synchronizer Control.



MODEL 406

SECTION 2
LIMITATIONS

To Right of Pilot's Altimeter.

| | MAX |
|------|------|
| RPM | TORQ |
| 1900 | 1382 |
| 1800 | 1459 |
| 1778 | 1477 |
| 1600 | 1477 |

Near Propeller Control Levers.

DO NOT
REVERSE WITH
PROPS FEATHERED

DO NOT ATTEMPT
REVERSE WITH
PROPELLERS FEATHERED

Airplanes -0001 thru -0010
Aileron Trim Indicator.

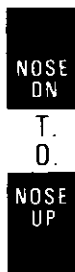
Airplanes -0011 and On



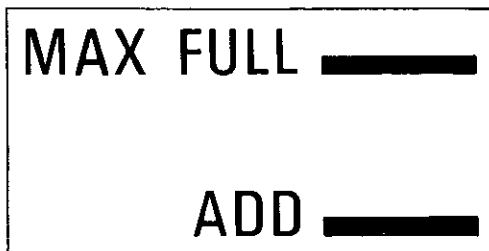
Rudder Trim Indicator.



Elevator Trim Indicator.



Inside Left Nose Baggage Door on Hydraulic Reservoir.



On Inner Side of Oil Filler Door:

ENGINE OIL
CAPACITY 9.2 US QUARTS
SEE PILOTS OPERATING HANDBOOK FOR
APPROVED OILS. ENTER OIL BRAND AND
TYPE IN ENGINE LOG BOOK. 5900181 29

On Inside of Nacelle Baggage Door (Left and Right)

**MAX
BAGGAGE
200 LBS**

Near Main Tank Filler Cap.

JET-A FUEL
237.5 US GAL USEABLE
ANTI-ICE ADDITIVE REQD
SEE PILOT'S OPERATING HANDBOOK FOR
OTHER APPROVED FUELS. QUANTITY AND
TYPE OF ADDITIVE AND FUELING PROCEDURE

On Executive Top and Writing Desk Top.

**TABLE MUST BE STOWED DURING
TAKE-OFF AND LANDING**

On Stowage Drawer

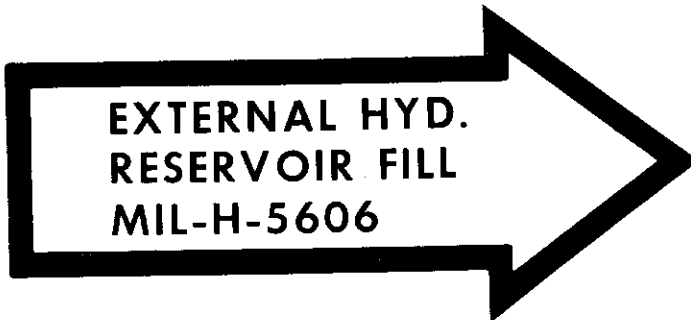
**DURING TAKEOFF & LANDING
DRAWER MUST BE IN STOWED
POSITION**

00116001

Inside Nose Baggage Doors.



Inside Left Nose Baggage Door.



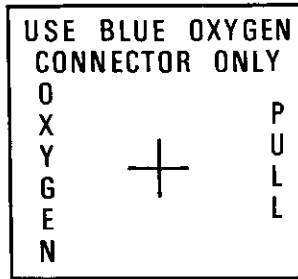
Inside Avionics Bay Door.



On Left Side Tailcone Forward of Rudder Hinge Line.



On Instrument Panel Near Oxygen Control (If Installed).



SECTION 3 EMERGENCY PROCEDURES

TABLE OF CONTENTS

| | Page |
|---|------|
| INTRODUCTION | 3-5 |
| AIRSPEDS FOR EMERGENCY OPERATIONS | 3-5 |

EMERGENCY PROCEDURES ABBREVIATED CHECKLIST

| | |
|---|------|
| Emergencies | 3-6 |
| ENGINE FAILURE | 3-6 |
| Engine Failure Before V_1 (Speed Below 98 KIAS) | 3-6 |
| Engine Failure After V_1 (Speed Above 98 KIAS) | 3-6 |
| Decision to Abort Takeoff | 3-7 |
| Engine Failure in Flight (Speed Below V_{MCA}) | 3-7 |
| Engine Failure in Flight (Speed Above V_{MCA}) | 3-7 |
| Both Engines Fail in Flight | 3-8 |
| Engine Securing Procedure | 3-8 |
| AIRSTART | 3-8 |
| Starter Assist | 3-8 |
| No Starter Assist | 3-9 |
| SMOKE AND FIRE | 3-10 |
| Engine Fire During Ground Operations (Sufficient Runway Remaining to Stop) | 3-10 |
| Cabin Fire During Ground Operations | 3-10 |
| Inflight Wing or Engine Fire | 3-10 |
| Inflight Cabin Electrical Fire or Smoke | 3-11 |
| Smoke Removal | 3-11 |
| EMERGENCY DESCENT | 3-12 |
| Preferred Procedure | 3-12 |
| In Turbulent Atmospheric Conditions | 3-12 |
| GLIDE | 3-12 |
| LANDING EMERGENCIES | 3-12 |
| Precautionary or Forced Landing With Power | 3-12 |
| Landing Without Power | 3-13 |
| Landing With Flat Main Gear Tire | 3-13 |
| Landing With Flat Nose Gear Tire | 3-14 |
| Landing With Defective Main Gear | 3-14 |

TABLE OF CONTENTS (CONTINUED)

| | Page |
|---|------|
| Landing With Defective Nose Gear | 3-15 |
| Landing With Power, Landing Gear Retracted | 3-15 |
| Landing With Wing Flaps Retracted | 3-15 |
| Engine Inoperative Landing | 3-16 |
| Engine Inoperative Go-Around (Speed Above 101 KIAS) | 3-16 |
| Ditching | 3-16 |
| SYSTEM EMERGENCIES | 3-17 |
| Propeller Synchrophaser Failure | 3-17 |
| Fuel System Emergency Procedures | 3-17 |
| Electrical System Emergency Procedures | 3-18 |
| Hydraulic Systems Emergencies | 3-20 |
| Environmental Systems Emergencies | 3-21 |
| Oxygen System Failure | 3-22 |
| Ice Protection Systems Emergencies | 3-22 |
| Avionics Bus Failure | 3-23 |
| Emergency Exits | 3-23 |
| Emergency Locator Transmitter Rescue Procedures | 3-24 |
| Encoding Altimeter Failure (Warning Flag Showing) | 3-24 |
| Transponder Procedures For Emergency Situations | 3-24 |
| Total Loss of Communications | 3-25 |
| Electric Elevator Trim Runaway | 3-25 |
| SPINS | 3-26 |

AMPLIFIED EMERGENCY PROCEDURES

| | |
|---|------|
| AIRSPEDS FOR EMERGENCY OPERATIONS | 3-27 |
| Maneuvering Speed (V_A) | 3-27 |
| Maximum Gliding Distance Speed | 3-27 |
| Air Minimum Control Speed (V_{MCA}) | 3-28 |
| One Engine Inoperative Best Rate-of-Climb Speed (V_{YSE}) | 3-28 |
| Takeoff Decision Speed (V_1) | 3-28 |
| Takeoff Safety Speed (V_2) | 3-28 |

TABLE OF CONTENTS (CONTINUED)

| | Page |
|---|------|
| Emergencies | 3-29 |
| ENGINE FAILURE | 3-29 |
| Engine Failure Before V_1 (Speed Below 98 KIAS) | 3-29 |
| Engine Failure After V_1 (Speed Above 98 KIAS) | 3-30 |
| Decision to Abort Takeoff | 3-30 |
| Engine Failure in Flight (Speed Below V_{MCA}) | 3-32 |
| Engine Failure in Flight (Speed Above V_{MCA}) | 3-33 |
| Both Engines Fail In Flight | 3-34 |
| Engine Securing Procedure | 3-35 |
| AIRSTART | 3-35 |
| Starter Assist (Preferred Procedure) | 3-35 |
| No Starter Assist | 3-36 |
| SMOKE AND FIRE | 3-38 |
| Engine Fire During Ground Operations (Sufficient Runway Remaining To Stop) | 3-38 |
| Cabin Fire During Ground Operations | 3-38 |
| Inflight Wing or Engine Fire | 3-38 |
| Inflight Cabin Electrical Fire or Smoke | 3-39 |
| Smoke Removal | 3-40 |
| Supplementary Information Concerning Airplane Fires | 3-40 |
| EMERGENCY DESCENT | 3-41 |
| Preferred Procedure | 3-41 |
| In Turbulent Atmospheric Conditions | 3-41 |
| GLIDE | 3-42 |
| LANDING EMERGENCIES | 3-43 |
| Precautionary or Forced Landing With Power | 3-43 |
| Landing Without Power | 3-43 |
| Landing With Flat Main Gear Tire | 3-44 |
| Landing With Flat Nose Gear Tire | 3-45 |
| Landing With Defective Main Gear | 3-45 |
| Landing With Defective Nose Gear | 3-46 |
| Landing With Power, Landing Gear Retracted | 3-46 |
| Landing With Wing Flaps Retracted | 3-47 |
| Engine Inoperative Landing | 3-47 |
| Engine Inoperative Go-Around (Speed Above 101 KIAS) | 3-48 |
| Ditching | 3-49 |

TABLE OF CONTENTS (CONTINUED)

| | Page |
|--|-------------------|
| SYSTEM EMERGENCIES | 3-49 |
| Engine Emergency Procedures | 3-49 |
| Propeller Synchrophaser Failure | 3-49 |
| Fuel System Emergency Procedures | 3-49 |
| Electrical System Emergency Procedures | 3-52 |
| Hydraulic System Emergencies | 3-54 |
| Environmental System Emergencies | 3-57 |
| Oxygen System Failure | 3-58 |
| Ice Protection Emergencies | 3-59 |
| Avionics Bus Failure | 3-61 |
| Emergency Exits | 3-61 |
| Cabin Door, Crew Door or Emergency Exit Not Secured Light Illuminated (Door Not Locked) | 3-61 |
| Nose Baggage Door Open on Takeoff | 3-62 |
| Emergency Locator Transmitter Rescue Procedures | 3-62 |
| Encoding Altimeter Failure (Warning Flag Showing) | 3-62 |
| Transponder Procedures For Emergency Situations | 3-62 |
| Total Loss of Communications | 3-63 |
| Electric Elevator Trim Runaway | 3-64 |
| SPINS | 3-64 |
| EMERGENCY INFORMATION | 3-65 (3-66 blank) |

INTRODUCTION

Section 3 describes the recommended procedures for emergency situations. The first part of this section provides emergency procedural action required in an abbreviated checklist form. Amplification of the abbreviated checklist is presented in the second part of this section.

NOTE

Refer to Section 9 for amended operating limitations, operating procedures, performance data and other necessary information for airplanes equipped with specific options.

AIRSPEEDS FOR EMERGENCY OPERATIONS

Conditions:

1. Takeoff Weight - 9360 Pounds.
2. Landing Weight - 9360 Pounds.
3. Standard Day, Sea Level.
4. Wing Flaps - T.O. Position Unless Otherwise Noted.
5. Landing Gear - UP.

| | |
|--|----------|
| (1) Maneuvering Speed With Wing Flaps UP (V_A) | 162 KIAS |
| (2) Maximum Gliding Distance Speed With Wing Flaps Up | 125 KIAS |
| (3) Air Minimum Control Speed (V_{MCA}) | 90 KIAS |
| (4) One Engine Inoperative Best Rate-of-Climb Speed With Wing Flaps UP (V_{YSE}) At Sea Level | 108 KIAS |
| (5) One Engine Inoperative Best Rate-of-Climb Speed With Wing Flaps UP (V_{YSE}) At 15,000 Feet | 104 KIAS |
| (6) Takeoff Decision Speed With Landing Gear Down (V_1) | 98 KIAS |
| (7) Takeoff Safety Speed (V_2) | 102 KIAS |

EMERGENCY PROCEDURES ABBREVIATED CHECKLIST

NOTE

This Abbreviated Emergency Procedures Checklist is included as a supplement to the Amplified Emergency Procedures Checklist. The Abbreviated Emergency Procedures Checklist should not be used until the flight crew has become familiar with the airplane and systems. All Amplified Emergency procedure items must be accomplished regardless of which checklist is used.

Procedures in the Abbreviated Checklist portion of this section shown in **bold face type** are immediate-action items and should be committed to memory.

EMERGENCIES

Engine Failure

ENGINE FAILURE BEFORE V_1 (Speed Below 98 KIAS)

- 1. Power Levers - GROUND IDLE.**
- 2. Brakes and Nosewheel Steering - AS REQUIRED.**

If Airplane Cannot be Stopped in Remaining Runway:

- 3. Fuel Control Levers - CUTOFF.**
- 4. Battery and Generators - OFF.**

ENGINE FAILURE AFTER V_1 (Speed Above 98 KIAS)

- 1. Aileron and Rudder - AS REQUIRED to maintain straight ahead flight (3 to 4 degrees bank with 1/2 ball slip into operative engine).**
- 2. Power - MONITOR.**
- 3. Landing Gear - UP when rate-of-climb is positive.**
- 4. Propeller - VERIFY feathered.**
- 5. Airspeed - MAINTAIN V_2 to 400 feet minimum, then increase to 108 KIAS.**
- 6. Wing Flaps - UP.**
- 7. Trim Tabs - ADJUST.**

After Reaching 1000 Feet Above Ground Level:

8. Inoperative Engine - SECURE.

DECISION TO ABORT TAKEOFF

1. Landing Gear - CHECK DOWN. Gear down lights on.
2. Power Levers - FLIGHT IDLE.
3. Power Levers - GROUND IDLE after touchdown.
4. Brakes, Propeller Reverse and Nosewheel Steering - AS REQUIRED.

If Airplane Cannot be Stopped in Remaining Runway

5. Fuel Control Levers - CUTOFF.
6. Battery and Generators - OFF.

ENGINE FAILURE IN FLIGHT (Speed Below V_{MCA})

1. Power Levers - RETARD to stop turn.
2. Aileron and Rudder - AS REQUIRED toward operative engine to maintain straight-ahead flight.
3. Pitch Attitude - LOWER NOSE to accelerate above 90 KIAS.
4. Accomplish procedures for Engine Failure in Flight (Speed above V_{MCA}).

ENGINE FAILURE IN FLIGHT (Speed above V_{MCA})

1. Inoperative Engine - DETERMINE. Idle engine same as idle foot; also, torque, ITT and N_g will be low.
2. Inoperative Engine Power Lever - RETARD.
3. Inoperative Engine Propeller - FEATHER.
4. Operative Engine - ADJUST.
5. Landing Gear - UP.
6. Airspeed - 108 KIAS minimum.
7. Wing Flaps - UP.
8. If airstart is warranted, refer to AIRSTART procedures.
9. If airstart is not warranted, refer to ENGINE SECURING procedures.

BOTH ENGINES FAIL IN FLIGHT

If Insufficient Altitude Exists to Permit Airstarts:

1. Refer to **LANDING WITHOUT POWER** procedures.

If Sufficient Altitude Exists to Permit Airstarts:

1. Propellers - **DO NOT FEATHER** if airstart is attempted.
2. Airstarts - **ATTEMPT**, refer to **AIRSTART-STARTER ASSIST** procedures.
3. If Airstarts Fail:
 - a. Propellers - **FEATHER**.
 - b. Airspeed - 125 KIAS (refer to Figure 3-1 Maximum Glide).
 - c. Refer to **LANDING WITHOUT POWER** procedures.

ENGINE SECURING PROCEDURE

1. **Autofeather - OFF.**
2. **Power Lever - FLIGHT IDLE.**
3. **Propeller Control Lever - FEATHER.**
4. **Fuel Control Lever - CUTOFF.**
5. Fuel Crossfeed Selector - **OFF** if fire hazard exists.
6. Fuel Auxiliary Boost Pump - **OFF** if fire hazard exists.
7. Cowl Flap - **CLOSED.**
8. Propeller Synchrophaser - **OFF.**
9. Generator - **OFF.**
10. Electrical Load - **REDUCE** if necessary and **MONITOR.**

AIRSTART

STARTER ASSIST

1. Electrical Load - **REDUCE.**
2. Air Conditioner - **OFF.**
3. Windshield Anti-Ice - **OFF.**
4. Autofeather - **OFF.**
5. Power Lever - One inch forward of **FLIGHT IDLE.**
6. Propeller Control Lever - Forward of **FEATHER.**
7. Fuel Control Lever - **CUTOFF.**
8. Fuel Quantity - **CHECK.**
9. Fuel Crossfeed Selector - **OFF.**
10. Fuel Auxiliary Boost Pump - **ON.**
11. Inoperative Engine Generator - **OFF.**
12. Operative Engine - **REDUCE ITT** to 650 degrees if practical.

13. Airspeed - 100 KIAS minimum.
14. Altitude - 20,000 feet maximum.
15. Start Switch - START; Check ignition light on.
16. Fuel Control Lever - RUN above 12 percent N_g
17. ITT and N_g - MONITOR (1090 degrees Celsius maximum).
18. Start Switch - OFF (N_g 52 percent or above).
19. Fuel Auxiliary Boost Pump - OFF MOMENTARILY, then NORMAL.
20. Propeller Control Lever - AS DESIRED.
21. Power Lever - AS DESIRED.
22. Generator - ON.
23. Electrical Equipment - AS REQUIRED.

NO STARTER ASSIST

1. Autofeather - OFF.
2. Power Lever - One inch forward of FLIGHT IDLE.
3. Propeller Control Lever - Forward of FEATHER.
4. Fuel Control Lever - CUTOFF.
5. Fuel Quantity - CHECK.
6. Fuel Crossfeed Selector - OFF.
7. Fuel Auxiliary Boost Pump - ON.
8. Inoperative Engine Generator - OFF.
9. Ignition Switch - ON, check light on.
10. Airspeed - 100 KIAS minimum (140 KIAS if propeller is feathered).
11. Altitude - 20,000 feet maximum (15,000 feet if propeller is feathered).
12. Fuel Control Lever - RUN (after N_g Stabilizes).
13. ITT and N_g - MONITOR (1090 degrees Celsius maximum).
14. Ignition Switch - NORMAL (N_g 52 percent or above).
15. Propeller Control Levers - AS DESIRED.
16. Power Lever - AS DESIRED.
17. Generator - ON.
18. Electrical Equipment - AS REQUIRED.
19. Fuel Auxiliary Boost Pump - OFF momentarily, then NORMAL.

SMOKE AND FIRE

ENGINE FIRE DURING GROUND OPERATIONS (Sufficient Runway Remaining to Stop)

- 1. Power Levers - GROUND IDLE.**
- 2. Brakes - AS REQUIRED.**
- 3. Fuel Control Levers - CUTOFF.**
- 4. Fuel Crossfeed Selector - OFF.**
- 5. Illuminated Fire Warning Light - PUSH to disable the generator, close the bleed air firewall and fuel shutoff valves and ARM fire bottle (if installed).**
- 6. Illuminated Fire Extinguisher Armed Light - PUSH (if installed).**
- 7. Emergency Assistance - REQUEST (if warranted).**
- 8. Battery Switch - OFF.**
- 9. As Soon As Practical - EVACUATE.**

CABIN FIRE DURING GROUND OPERATIONS

- 1. Power Levers - GROUND IDLE.**
- 2. Brakes - AS REQUIRED.**
- 3. Fuel Control Levers - CUTOFF.**
- 4. Emergency Assistance - REQUEST (if warranted).**
- 5. Battery Switch - OFF.**
- 6. Portable Fire Extinguisher - USE as required.**
- 7. As Soon As Practical - EVACUATE.**

INFLIGHT WING OR ENGINE FIRE

- 1. Power Lever Affected Engine - FLIGHT IDLE.**
- 2. Propeller Control Lever Affected Engine - FEATHER.**
- 3. Fuel Control Lever Affected Engine - CUTOFF.**
- 4. Fuel Auxiliary Boost Pump Affected Engine - OFF.**
- 5. Illuminated Fire Warning Light - PUSH to disable the generator, close the bleed air firewall and fuel shutoff valves and ARM fire bottle (if installed).**
- 6. Illuminated Fire Bottle Light - PUSH (if installed).**
- 7. Fuel Crossfeed Selector - OFF.**
- 8. Engine Securing Procedure - COMPLETE.**
- 9. As Soon As Practical - LAND and EVACUATE.**

INFLIGHT CABIN ELECTRICAL FIRE OR SMOKE

If Source Is Known:

1. **Oxygen - Use as required (If installed).**
2. **Faulty Equipment - OFF.**
3. **Fire - EXTINGUISH.**
4. **Smoke Removal Procedure - INITIATE if warranted.**
5. **As Soon As Practical - LAND.**

If Source of Fire or Smoke is Unknown:

1. **Oxygen - USE as required (if installed).**
2. **Nonessential Equipment - OFF.**
3. **Smoke Removal Procedure - INITIATE if warranted.**
4. **If fire or smoke ceases, land as soon as practical.**
5. **If fire or smoke persists:**
 - a. **Fuel Crossfeed Selector - OFF.**
 - b. **Battery and Generators - OFF.**
 - c. **Fire - EXTINGUISH.**
6. **If fire or smoke still persists, land as soon as possible.**
7. **If fire or smoke decreases and if possible, maintain VFR and land as soon as practical.**
8. **If unable to maintain VFR:**
 - a. **Circuit Breakers - PULL.**
 - b. **Battery - ON.**
 - c. **Generators - ON one at a time.**
 - d. **Essential Circuit Breakers - PUSH one at a time; then, pause to check for evidence of smoke.**
 - e. **Faulty Equipment - OFF.**
 - f. **Fire - EXTINGUISH.**
 - g. **Unaffected Essential Equipment - AS REQUIRED.**
9. **As Soon As Practical - LAND**

SMOKE REMOVAL

1. **Source of Smoke - IDENTIFY and ELIMINATE.**
2. **Cabin Divider Curtain - OPEN (If installed).**
3. **Use Of Supplemental Oxygen - AS REQUIRED (If installed).**
4. **If Source of Smoke Cannot Be Eliminated:**
 - a. **EMERGENCY DESCENT - INITIATE (as required).**
 - b. **Cabin Air Control - PULL RAM AIR control knob, PUSH knob if intensity of smoke increases.**
5. **As Soon As Practical - LAND.**

EMERGENCY DESCENT

PREFERRED PROCEDURE

1. Power Levers - **FLIGHT IDLE.**
2. Propeller Control Levers - **FORWARD.**
3. Wing Flaps - **UP.**
4. Landing Gear - **UP.**
5. Airspeed - **229 KIAS/0.52 Mach.**

IN TURBULENT ATMOSPHERIC CONDITIONS

1. Power Levers - **FLIGHT IDLE.**
2. Propeller Control Levers - **FORWARD.**
3. Wing Flaps - **APPR Below 200 KIAS.**
4. Landing Gear - **DOWN.**
5. Wing Flaps - **LAND Below 180 KIAS.**
6. Airspeed - **180 KIAS.**

GLIDE

1. Wing Flaps - **UP.**
2. Landing Gear - **UP.**
3. Propellers - **FEATHERED.**
4. Cowl Flaps - **CLOSED.**
5. Best Glide Speed - **125 KIAS.**

LANDING EMERGENCIES

PRECAUTIONARY OR FORCED LANDING WITH POWER

1. Landing Site - **CHECK.** Fly over 120 KIAS and APPR flaps.
2. Landing Gear - **DOWN** or **UP** (at pilot's discretion).
3. Cabin Heat Source Select - **OFF.**
4. Nonessential Equipment - **OFF.**
5. Fuel Crossfeed Selector - **OFF.**
6. Fuel Auxiliary Boost Pumps - **OFF.**
7. Emergency Exit Windows - **OPEN** if passenger is available.
8. Wing Flaps - **LAND.**
9. Landing - **INITIATE** (in nose high attitude).
 - a. Fuel Control Levers - **CUTOFF** after touchdown.
 - b. Battery - **OFF.**

LANDING WITHOUT POWER

1. Flaps - Approach (When Landing Site is Assured).
 - a. Fuel Control Levers - CUTOFF.
 - b. Wing Flaps - APPR.
 - c. Starter Switch - MOTOR. OFF after wing flaps reach the APPR position.
2. Engine Securing Procedure - COMPLETE.
3. Nonessential Equipment - OFF.
4. Fuel Crossfeed Selector - OFF.
5. Landing Gear - DOWN (The pilot may elect to land gear up depending on terrain).
 - a. Landing Gear Switch - DOWN.
 - b. LDG GEAR System Circuit Breaker - PULL.
 - c. Emergency Gear Extension T-Handle - PULL below 130 KIAS, within gliding distance of field.
6. Battery Switch - OFF (Day).
7. Emergency Exit Windows - OPEN if passenger is available.
8. Approach - 110 KIAS with APPR FLAPS (125 KIAS with 0° flaps).
9. Landing - INITIATE (in nose high attitude).

LANDING WITH FLAT MAIN GEAR TIRE

If a blowout occurs during takeoff and the takeoff is continued, proceed as follows:

1. **Landing Gear - LEAVE DOWN.**
2. Fuel Crossfeed selector - AS REQUIRED to burn off fuel from the tank over the defective tire. Do not exceed 300 pounds asymmetric fuel loading.
3. Fuel Crossfeed Selector - OFF.
4. If a crosswind landing is required, select a runway with a crosswind from the side opposite the defective tire.
5. Before Landing Checklist - COMPLETE.
6. In approach, align airplane with edge of runway opposite the defective tire, allowing room for a mild turn in the landing roll.
7. Land slightly wing-low on the side of inflated tire and lower nosewheel for positive steering.
8. Use full aileron in landing roll to lighten load on defective tire.
9. Apply brakes on the inflated tire to minimize landing roll and to maintain directional control.
10. Stop airplane to avoid further damage unless runway must be cleared for other traffic.

LANDING WITH FLAT NOSE GEAR TIRE

If a blowout occurs during takeoff and the takeoff is continued, proceed as follows:

1. **Landing Gear - LEAVE DOWN.**
2. Passengers and Baggage - **MOVE AFT.**
3. Approach - 110 KIAS with APPR wing flaps.
4. Landing Attitude - **NOSE HIGH** with power.
5. Nosewheel - **HOLD OFF** during landing roll.
6. Brakes - **MINIMUM** during landing roll.
7. Power Levers - **FLIGHT IDLE.**
8. Control Wheel - **FULL AFT** until airplane stops.
9. Taxiing - **MINIMIZE** to prevent further damage.

LANDING WITH DEFECTIVE MAIN GEAR

1. Fuel Crossfeed Selector - **AS REQUIRED** to burn off fuel from the tank over gear. Do not exceed 300 pounds asymmetric fuel loading.
2. Fuel Crossfeed Selector - **OFF.**
3. Select headwind or crosswind opposite defective gear.
4. **Before Landing Checklist - COMPLETE.**
5. Align airplane near the edge of runway opposite the defective landing gear.
6. Battery Switch - **OFF (day).**
7. Land wing low toward operative landing gear. Lower nosewheel immediately for positive steering.
8. Start a moderate ground loop into defective landing gear.
9. Fuel Control Levers - **CUTOFF.**
10. Use full aileron in landing roll to lighten the load on the defective gear.
11. Apply brakes only on the operative landing gear to hold desired rate of turn and shorten landing roll.
12. Fuel Auxiliary Boost Pumps - **OFF.**

LANDING WITH DEFECTIVE NOSE GEAR

1. Passengers and Baggage - MOVE AFT.
2. Landing Gear - DOWN.
3. Approach - 110 KIAS with APPR wing flaps.
4. Battery Switch - OFF.
5. Landing Attitude - NOSE HIGH with power.
6. Fuel Control Levers - CUTOFF.
7. Nosewheel - HOLD OFF during landing roll.

LANDING WITH POWER, LANDING GEAR RETRACTED

1. Cabin Heat Source Select Knob - OFF.
2. Nonessential Equipment - OFF.
3. Fuel Crossfeed Selector - OFF.
4. Fuel Auxiliary Boost Pumps - OFF.
5. Emergency Exit Windows - OPEN if passenger is available.
6. Approach - 110 KIAS with APPR wing flaps.
7. Wing Flaps - LAND when landing is assured.
8. Landing - INITIATE (in nose high attitude).

LANDING WITH WING FLAPS RETRACTED

1. Propeller Control Levers - FORWARD.
2. Fuel Crossfeed Selector - OFF.
3. Approach Speed - 125 KIAS.
4. Landing Gear - DOWN.

ENGINE INOPERATIVE LANDING

1. Fuel Balance - CHECK within limits.
2. Fuel Crossfeed Selector - OFF.
3. Passenger Advisory Lights - AS REQUIRED.
4. Cowl Flaps - AS REQUIRED.
5. Altimeter - SET.
6. Seat Belts and Shoulder Harness - SECURE.
7. Propeller Control Lever - FORWARD.
8. Autofeather - OFF.
9. Wing Flaps - T.O.
10. Approach at 110 KIAS.
11. Landing Gear - DOWN within gliding distance of field.
12. Rudder Trim - CENTER as power is reduced.
13. Wing Flaps - LAND when landing is assured.
14. Decrease speed below 100 KIAS only when landing is assured.
15. Air Minimum Control Speed - 90 KIAS.
16. Power Lever - GROUND IDLE after touchdown.
17. Nosewheel - LOWER GENTLY.
18. Brakes, Propeller Reverse and Nosewheel Steering - AS REQUIRED.

ENGINE INOPERATIVE GO-AROUND (Speed above 101 KIAS)

1. Power Lever - ADVANCE to takeoff power while maintaining straight-ahead flight. Maintain 3 to 4 degrees bank with 1/2 ball slip into operative engine.
2. Wing Flaps - T.O.
3. Positive Rate-of-Climb - ESTABLISH at 102 KIAS.
4. Landing Gear - UP.
5. Climb to Clear Obstacles - 102 KIAS.
6. Airspeed - ACCELERATE to 108 KIAS.
7. Wing Flaps - UP.
8. Trim Tabs - ADJUST.
9. Cowl Flaps - AS REQUIRED.

DITCHING

1. Landing Gear - UP.
2. Approach - HEADWIND if high winds.
- PARALLEL to SWELLS if light wind and heavy swells.
3. Wing Flaps - LAND.

4. Power - AS REQUIRED (300 feet per minute rate-of-descent).
5. Airspeed - 100 KIAS.
6. Attitude - DESCENT ATTITUDE through touchdown. Do not flare.

SYSTEM EMERGENCIES

PROPELLER SYNCHROPHASER FAILURE

1. Propeller Synchrophaser - OFF.

FUEL SYSTEM EMERGENCY PROCEDURES

Main Fuel Ejector and Fuel Auxiliary Boost Pump Failure (L or R FUEL PRESS LOW Light Illuminated)

1. Fuel Crossfeed Selector - OFF.
2. Fuel Auxiliary Boost Pump - ON.
3. Fuel Auxiliary Boost Circuit Breaker - CHECK. Reset as required.
4. If FUEL PRESS LOW light remains illuminated:
 - a. Affected Fuel Auxiliary Boost Pump - OFF.
 - b. If FUEL PRESS LOW light goes out, refer to AUXILIARY BOOST PUMP FAILURE procedure.
5. If FUEL PRESS LOW light still remains illuminated (confirmed dual failure):
 - a. Maintain coordinated flight.
 - b. Do not exceed ± 10 degrees pitch attitude.
 - c. Unusable fuel in the affected side is 150 pounds in level attitudes and 300 pounds in nose up or down attitude up to ± 10 degrees.

CAUTION

WHEN CROSSFEEDING FROM OPPOSITE TANK, FUEL IMBALANCE WILL INCREASE RAPIDLY DUE TO THE 500-800 POUND PER HOUR RATE OF TRANSFER BETWEEN TANKS.

- d. Crossfeed from opposite tank and/or suction feed as required to maximize fuel availability and control fuel balance. Descend as required to provide stable fuel flow indication on affected engine when suction feeding. Crossfeed is unavailable from affected tank.
- e. As Soon As Practical - LAND.

**Fuel Transfer Ejector Pump Failure (L or R XFER PUMP FAIL
Light Illuminated with fuel quantity greater than 35 pounds)**

1. Fuel Crossfeed Selector - OFF (If applicable).
2. Fuel Auxiliary Boost Pump - ON.
3. Fuel Auxiliary Boost Circuit Breaker - CHECK. Reset as required.
4. If condition not rectified:
 - a. Maintain coordinated flight.
 - b. Maintain pitch attitude within ± 15 degrees.
 - c. Unusable fuel in the affected tank increases 20 pounds.

**Fuel Auxiliary Boost Pump Failure (L or R AUX PUMP ON and
L or R FUEL PRESS LOW light illuminated or L or R AUX
PUMP ON Light goes out when fuel auxiliary boost pump
should be operating)**

1. Fuel Crossfeed Selector - OFF.
2. Affected Fuel Auxiliary Boost Pump - ON.
3. Affected Fuel Auxiliary Boost Circuit Breaker - CHECK. Reset as required.
4. If proper operation not restored:
 - a. Affected Fuel Auxiliary Boost Pump - OFF.
 - b. Check L or R FUEL PRESS LOW Light - OFF.
5. If using Aviation Gasoline - Maintain 18,000 feet altitude or below if feasible.
6. If corresponding XFER PUMP FAIL Light becomes illuminated (below approximately 230 pounds per tank) - Refer to TRANSFER EJECTOR PUMP FAILURE procedure.

ELECTRICAL SYSTEM EMERGENCY PROCEDURES

Generator Failure Light Illuminated (L or R GEN OFF)

1. Electrical Load - DECREASE as required to prevent discharge of the battery.
2. GEN CONTROL Circuit Breakers - CHECK. Reset as required.
3. Affected Generator - RESET then ON.
4. If Normal Generator Operation Does Not Occur:
 - a. Affected Generator - OFF.

Engine Start Light Remains Illuminated After Engine Start (L or R START)

1. Battery Switch - OFF.
2. Auxiliary Power Unit - DISCONNECT (If connected).
3. Fuel Control Lever - CUTOFF.
4. Engine Shutdown - COMPLETE.

Battery Overheat Light Illuminated (BATT O'HEAT)

If Light Illuminates Continuously:

1. **Battery Switch - OFF.**
2. Left Ammeter - CHECK while holding BATT/L GEN switch in BATT position.
 - a. If ammeter shows zero indication:
 - (1) Light should extinguish.
 - b. If ammeter shows up scale indication:
 - (1) Generators - OFF.
 - (2) All Electrical System Switches - OFF.
 - (3) After 5 minutes:
 - (a) Either Generator - ON.
 - (b) Left Ammeter - CHECK while holding BATT/L GEN switch in BATT position.
 - 1) If ammeter shows up scale indication:
 - a) Generator - OFF.
 - 2) If ammeter shows zero indication:
 - a) Generators - ON.
 - b) Reinstate electrical systems as required.
 - c) Monitor overheat lights.
 3. As Soon As Practical - LAND.

If Light Begins Flashing:

1. Battery Switch - CHECK OFF.
2. Generators - OFF.
3. All Electrical Systems Switches - OFF.
4. After 5 Minutes:
 - a. Either Generator - ON.
 - b. Left Ammeter - CHECK while holding BATT/L GEN switch in BATT position.
 - (1) If ammeter shows up scale indication:
 - (a) Generator - OFF.
 - (2) If ammeter shows zero indication:
 - (a) Generators - ON.
 - (b) Reinstate electrical systems as required.
 - (c) Monitor overheat lights.
5. As Soon As Practical - LAND.

Inverter Failure Light Illuminated (AC FAIL)

1. If Optional Dual Inverter Installed:
 - a. Inverter Switch - Select other inverter.

HYDRAULIC SYSTEMS EMERGENCIES

Hydraulic Pressure Light Illuminated After Wing Flaps or Landing Gear Retraction or Extension (HYD PRESS ON)

1. Airspeed - 130 KIAS or less.
2. LDG GEAR and FLAP CONTROL System Circuit Breakers - CYCLE to determine which system is causing the malfunction.
3. Landing Gear and/or Wing Flap Switch - RAPIDLY RECYCLE.
4. If Light Fails to go Out and Wing Flaps are Causing the Malfunction:
 - a. Wing Flaps Switch - MOVE slightly away from selected position.
 - b. If Light Remains Illuminated:
 - (1) Wing Flaps Switch - SELECT desired position.
 - (2) FLAP CONTROL System Circuit Breaker - PULL after wing flaps reach desired position.
5. If Light Fails to go Out and Landing Gear is Causing the Malfunction:
 - a. Landing Gear Switch - RAPIDLY RECYCLE.
 - b. If Light Remains Illuminated:
 - (1) Landing Gear Switch - SELECT desired position.
 - (2) LDG GEAR System Circuit Breaker - PULL after landing gear reaches desired position.
6. Before Landing - RESET applicable circuit breaker.

Landing Gear Down And Locked Light Illuminated With Gear Handle Up And Hyd Press Light Out

1. Perform "LANDING GEAR WILL NOT EXTEND HYDRAULICALLY" Procedure in this section.

Landing Gear Will Not Extend Hydraulically

1. Airspeed - 130 KIAS or less.
2. Landing Gear Switch - DOWN.
3. LDG GEAR Systems Circuit Breaker - PULL.
4. Emergency Gear Extension T-Handle - PULL.
5. Gear Down Lights - ON; Unlocked Light - OFF.
6. If Main Gear Does Not Lock Down - **YAW AIRPLANE**. Airloads will lock main gear down if up locks have released.
7. Gear Warning Horn - CHECK.
8. As Soon As Practical - LAND.

Landing Gear Will Not Retract Hydraulically

1. Landing Gear Switch - DOWN.
2. Gear Down Lights - ON; Unlocked Light - OFF.
3. Gear Warning Horn - CHECK.
4. As Soon As Practical - LAND.

ENVIRONMENTAL SYSTEMS EMERGENCIES**Wing Overheat Light Illuminated (L or R WING O'HEAT)**

1. Audibly verify bleed air flow is terminated.
2. If Doubt Exists Regarding Bleed Air Termination:
 - a. Cabin Heat Auto/Manual Control - **MANUAL**.
 - b. Cabin Manual Temperature Switch - **WARMER** for 10 seconds.
 - c. Cabin Heat Source Selector - **SELECT** the affected engine momentarily. No heat indicates the bleed air flow has been terminated.
3. If WING O'HEAT Light Does Not Go Out In Two Minutes:
 - a. Affected Engine - **SECURE** (refer to Engine Securing Procedure).
 - b. Operative Engine - **ADJUST**.
 - c. Trim Tabs - **ADJUST** to maintain bank toward operative engine.
 - d. Electrical Load - **DECREASE** if required to prevent battery discharge.
 - e. Fuel Crossfeed Selector Selector - **AS REQUIRED** to maintain fuel balance. Do not crossfeed if fire hazard exists.
 - f. As Soon As Practical - **LAND**.

Air Duct Overheat Light Illuminated (AIR DUCT O'HEAT)

1. Temperature Control Knob - MANUAL (Full counterclockwise).
2. Manual Warmer/Cooler Switch - COOLER for approximately 15 seconds.
3. Ram Air Control - PUSH.
4. Cockpit/Cabin Air Control - PULL.
5. Cabin Air Defrost Knob - PULL.
6. If AIR DUCT O'HEAT light does not go out in two minutes:
 - a. Cabin Heat Source Select Switch - OFF.
 - b. As Soon As Practical - LAND.

Bleed Air Contamination

1. Cabin Heat Source Select - OFF.
2. Ram Air Knob - Pull to Clear Cockpit.
3. Cabin Heat Source Select - LH then RH (to isolate source).
4. If air contamination continues:
 - a. If supplementary oxygen is available:
 - (1) Oxygen Knob - PULL ON.
 - (2) Assure each occupant is using oxygen.
 - b. Smoke Removal Checklist - COMPLETE.

OXYGEN SYSTEM FAILURE (IF INSTALLED)

1. Maintain altitude below 10,000 feet.

ICE PROTECTION SYSTEMS EMERGENCIES

Inadvertent Icing Encounter

1. Ignition Switches - ON.
2. Engine Inertial Separator Switches - BYPASS.
3. Pitot/Static Heat Switches - ON.
4. Stall Heat Switches - ON.
5. Propeller Deice Switches - ON.
6. Ignition Switches - OFF after 5 minutes operation.
7. Leave icing conditions as soon as possible.

Engine Inertial Separator System Failure

1. Inertial Separator - **BYPASS** (monitor Inertial Separator lights)
2. Check proper operation by noting torque drop and slight rise in **ITT**.
3. If Inertial Separator fails in the **NORMAL** Mode - Turn ignition switches **ON** and leave icing conditions as soon as possible.

Pitot/Static System Failure

1. Pitot/Static Heat Switches - **CHECK ON**.
2. Pilot's and Copilot's Instruments - **DETERMINE** which instruments are functioning normally.
3. Complete flight on the operative instruments.

Propeller Deice Failure

1. Propeller Control Lever - **EXERCISE** then return to **CRUISE**.
2. Propeller Ammeter - **CHECK** for proper operation by periodic fluctuations within the green arc.
3. If ammeter reading is below the green arc, indicating the propeller blades may not be deicing uniformly:
 - a. Propeller Deice Switch - **OFF** for affected propeller.
4. Leave icing conditions as soon as possible.

Boot Operation With One Engine Inoperative.

1. Power Lever - **SET** (above 65 percent N_g during deice boot actuation).

AVIONICS BUS FAILURE

1. Applicable Avionics Bus Switch Breaker - **RESET** after 3 minutes.
2. If Switch Breaker Trips Again - **OFF**.
3. Determine which Avionics Systems are inoperative.

EMERGENCY EXITS

Emergency Exit Window Opening

1. Emergency Release Handle - **ROTATE FORWARD**.
2. Emergency Exit Window - **PUSH OUT** and **UP** until the uplock brace holds the window open.

Cabin Door, Crew Door or Emergency Exit Not Secured Light Illuminated (DOOR NOT LOCKED)

1. Airspeed - Reduce As Required.
2. Passenger Advisory Lights - As Required.
3. As Soon As Practical - LAND.

EMERGENCY LOCATOR TRANSMITTER RESCUE PROCEDURES

Before Landing

1. VHF COM - SET 121.5 MHz or known ATC frequency and transmit May Day calls for assistance if time permits.

After Landing

1. Plug Button - REMOVE (located on side of tailcone).
2. Emergency Locator Transmitter Switch - ON.

After Rescue

1. Emergency Locator Transmitter Switch - OFF.

ENCODING ALTIMETER FAILURE (Warning Flag Showing)

Encoding Altimeter Failure (Warning Flag Showing)

1. ALT Circuit Breaker - CHECK IN.
2. If warning flag is still showing, use the standby barometric altimeter.

TRANSPONDER PROCEDURES FOR EMERGENCY SITUATIONS

Emergency Signal Transmission

1. Function Switch - ON.
2. Reply-Code Selector Switches - SELECT Code 7700.

Loss-of-Communications Signal Transmission

1. Function Switch - ON.
2. Reply-Code Selector Switches - SELECT Code 7700; WAIT 1 minute, THEN SELECT Code 7600; WAIT 15 minutes. Repeat procedures at same intervals for remainder of flight.

Hijacked Signal Transmission

1. Function Switch - ON.
2. Reply-Code Selector Switches - SELECT Code 7500.

TOTAL LOSS OF COMMUNICATIONS

In the event that the audio panel or a microphone malfunctions such that COM operation cannot be performed on COM 1, COM 2 or COM 3, proceed as follows:

1. Employ an alternate microphone.

If the Problem Continues:

2. Function Selector Switch - EMER COM. Speaker operation will be inoperative in all modes.
3. Employ headsets.
4. Set the desired frequency on COM 1 and proceed with communication on that COM only.
5. Set receiver selector switches to HDST for receivers to be monitored (NAV, MKR, ADF or DME). A reduction in normal amplitude will be experienced while operating in emergency mode.

If Communications Cannot Be Re-established:

6. Refer to Transponder Procedures for Emergency Situations.
7. Comply with ATC procedures for loss of communications.

ELECTRIC ELEVATOR TRIM RUNAWAY

1. Control Wheel - OVERPOWER as required.
2. AP/TRIM Disconnect Switch - DISCONNECT immediately.
3. Manual Elevator Trim - AS REQUIRED.

NOTE

After the electric trim has been disconnected and the emergency is over, pull the electric trim (ELEV TRIM) circuit breaker. Do not attempt to use the electric elevator trim system until ground maintenance has been completed.

SPINS

Intentional spins are not permitted in this airplane. Should a spin occur the following recovery procedures should be employed:

1. **Power Levers - FLIGHT IDLE.**
2. **Ailerons - NEUTRALIZE.**
3. **Rudder - HOLD FULL RUDDER** opposite the direction of rotation.
4. **Control Wheel - FORWARD BRISKLY, 1/2 turn of spin** after applying full rudder.
5. **Inboard Engine - INCREASE POWER** to slow rotation. (If Necessary).

After rotation has stopped:

6. **Rudder - NEUTRALIZE.**
7. **Inboard Engine (If used) - DECREASE POWER** to equalize engines.
8. **Control Wheel - PULL** to recover from resultant dive. Apply smooth steady control pressure.

AMPLIFIED EMERGENCY PROCEDURES

NOTE

A complete knowledge of the procedures set forth in this section will enable the pilot to cope with various emergencies that can be encountered; however, this does not diminish the fact that the primary responsibility of the pilot is to maintain control at all times. Good judgment and precise action are essential and can only be developed through frequent practice of emergency and simulated engine inoperative procedures. The pilot must have a thorough knowledge of all emergency procedures so that in the event of an emergency, reaction will be precise and done with confidence. This is required so the pilot can cope with the demands of an emergency situation.

AIRSPEEDS FOR EMERGENCY OPERATIONS

The most critical time for an engine failure in a multi-engine airplane is during a two or three second period late in the takeoff run while the airplane is accelerating to V_1 . A detailed knowledge of recommended one engine inoperative airspeeds is essential for safe operation of the airplane.

The airspeed indicator is marked with a red radial at the air minimum control speed and a blue arc at the one engine inoperative best rate-of-climb speed to facilitate instant recognition. The following paragraphs present a detailed discussion of the problems associated with airplane emergencies.

MANEUVERING SPEED (V_A)

Maneuvering speed becomes important when the airplane is approaching maximum operating limit speed. Maneuvering speed of 162 KIAS at gross weight is the maximum speed at which application of full available aerodynamic control will not overstress the airplane structure.

MAXIMUM GLIDING DISTANCE SPEED

In the event of both engines-failure condition, maximum gliding distance can be obtained by feathering both propellers, and maintaining approximately 125 KIAS with landing gear and wing flaps up at the weight of 9360 pounds, refer to Figure 3-1.

AIR MINIMUM CONTROL SPEED (V_{MCA})

The multi-engine airplane must reach the air minimum control speed of 90 KIAS before full control deflections can counteract the adverse rolling and yawing tendencies associated with one engine inoperative and full power operation on the other engine with wing flaps in T.O. position. This speed is indicated by a red radial on the airspeed indicator.

NOTE

Buffet can be encountered as high as 95 KIAS with airplane at maximum takeoff weight and the wing flaps in the UP position.

ONE ENGINE INOPERATIVE BEST RATE-OF-CLIMB SPEED (V_{YSE})

The one engine inoperative best rate-of-climb speed becomes important when there are no obstacles ahead on takeoff, or when it is difficult to maintain or gain altitude in one-engine emergencies. The one engine inoperative best rate-of-climb speed is 108 KIAS with wing flaps and landing gear up at sea level. The speed is indicated by a blue arc 104 to 108 KIAS on the airspeed indicator.

The variations of wing flaps up, one engine inoperative best rate-of-climb speed with altitude are shown in Section 5. For one engine inoperative best climb performance, the wings should be banked 3 to 4 degrees toward the operative engine.

TAKEOFF DECISION SPEED (V_1)

The takeoff decision speed is the airspeed on the ground at which, as a result of engine failure or other reasons, a decision is made to continue or discontinue the takeoff. At speeds below V_1 the takeoff is discontinued. At speeds above V_1 the takeoff is continued as one engine inoperative takeoff. V_1 is 98 KIAS and is the same speed as V_R for this airplane.

TAKEOFF SAFETY SPEED (V_2)

The takeoff safety speed is the speed at 50 feet above the runway surface as demonstrated during takeoff with one engine inoperative with wing flaps in the T.O. position. The one engine inoperative takeoff climb gradients with landing gear up are also specified at this speed. V_2 is 102 KIAS.

EMERGENCIES

Engine Failure

ENGINE FAILURE BEFORE V_1 (Speed Below 98 KIAS)

1. Power Levers - GROUND IDLE.
2. Brakes and Nosewheel Steering - AS REQUIRED.

CAUTION

IF NECESSARY, CAUTIOUSLY APPLY REVERSING AS REQUIRED ON THE OPERATING ENGINE. TO MAINTAIN DIRECTIONAL CONTROL, THE REVERSE THRUST IS COUNTERACTED BY OPPOSITE BRAKE AND RUDDER. IF RUNWAY BRAKING ACTION IS LESS THAN NORMAL DUE TO LOOSE GRAVEL, SOD SURFACE, SNOW, ICE OR RAIN, CAREFUL MODULATION OF POWER WILL BE REQUIRED TO MAINTAIN DIRECTIONAL CONTROL.

If Airplane Cannot be Stopped in Remaining Runway:

3. Fuel Control Levers - CUTOFF.
4. Battery and Generators - OFF.

NOTE

The distance required for the airplane to be accelerated from a standing start to V_1 on the ground, and to decelerate to a stop with heavy braking, is presented in the Accelerate Stop Distance Chart in Section 5 for various combinations of conditions.

ENGINE FAILURE AFTER V_1 (Speed above 98 KIAS)

1. Aileron and Rudder - **AS REQUIRED** to maintain straight ahead flight (3 to 4 degrees bank with 1/2 ball slip into operative engine).

NOTE

Uncoordinated flight in bank greater than 5 degrees will decrease the usable fuel.

2. Power - **MONITOR.**
3. Landing Gear - **UP** when rate-of-climb is positive.
4. Propeller - **VERIFY** feathered.

WARNING

DO NOT REDUCE EITHER ENGINE'S POWER LEVER BELOW TAKEOFF SETTING. TO DO SO WILL INACTIVATE THE AUTOFEATHER FEATURE.

5. Airspeed - **MAINTAIN V_2 to 400 feet minimum, then increase to 108 KIAS.**
6. Wing Flaps - **UP.**
7. Trim Tabs - **ADJUST.**

After Reaching 1000 Feet Above Ground Level:

8. Inoperative Engine - **SECURE.** Refer to Engine Securing Procedure.

DECISION TO ABORT TAKEOFF

1. Landing Gear - **CHECK DOWN.** Gear Down Lights On.
2. Power Levers - **FLIGHT IDLE.**

WARNING

DO NOT RETARD POWER LEVERS BELOW FLIGHT IDLE WHILE AIRBORNE.

3. Power Levers - **GROUND IDLE** after touchdown.
4. Brakes, Propeller Reverse and Nosewheel Steering - **AS REQUIRED.**

If airplane cannot be stopped in remaining runway.

5. Fuel Control Levers - CUTOFF.
6. Battery and Generators - OFF.



IF NECESSARY, CAUTIOUSLY APPLY REVERSING AS REQUIRED ON THE OPERATING ENGINE. TO MAINTAIN DIRECTIONAL CONTROL, THE REVERSE THRUST IS COUNTERACTED BY OPPOSITE BRAKE AND RUDDER. IF RUNWAY BRAKING ACTION IS LESS THAN NORMAL DUE TO LOOSE GRAVEL, SOD SURFACE, SNOW, ICE OR RAIN, CAREFUL MODULATION OF POWER WILL BE REQUIRED TO MAINTAIN DIRECTIONAL CONTROL.

To make an intelligent decision in this type of emergency, one must consider the field length, field elevation, air temperature, headwind, takeoff weight and obstruction height. The limitations of one engine climb performance shown in Section 5 should be reviewed before takeoff. Accelerate stop and accelerate go distances are predicated on the pilot recognizing an engine failure at V_1 . If the airplane has already left the runway when an emergency occurs, it is normally considered prudent to continue the takeoff unless the deteriorating nature of the emergency indicates that continued flight may become impossible.

If a decision is made to land, the pilot should realize (1) the airplane may be as much as 12 knots below the safe T.O. Flap setting approach speed and (2) that the total distance to complete the maneuver will greatly exceed published accelerate stop distance.

At sea level, standard day, with zero wind and 9360 pounds weight, the distance to accelerate to 98 KIAS and stop is 4228 feet, while the total unobstructed distance required to takeoff and climb over a 50-foot obstacle after an engine failure at 98 KIAS is 3865 feet. This total distance over an obstacle can be reduced slightly under more favorable conditions of weight, headwind, or obstruction height. Still higher field elevations will cause the engine failure takeoff distance to lengthen until the altitude is reached where a successful takeoff is improbable unless the airspeed and height above the runway at engine failure are great enough to allow a slight deceleration and altitude loss while the airplane is being cleaned up for an engine inoperative climb.

During a one engine inoperative takeoff over an obstacle, one condition presents an appreciable advantage; this is headwind. A decrease of approximately 5 percent in ground distance required to clear a 50-foot obstacle can be gained for each 10 knots of headwind. Excessive speed above one engine inoperative best rate-of-climb speed at engine failure is not nearly as advantageous as one might expect since deceleration is rapid and ground distance is used up quickly at higher speeds while the airplane is being cleaned up for climb. However, the extra speed is important for controllability.

The following facts should be used as a guide at the time of engine failure during takeoff: (1) altitude is more valuable to safety after takeoff than is airspeed in excess of the one engine inoperative best rate-of-climb speed since excess airspeed is lost much more rapidly than is altitude; (2) climb or continued level flight at moderate altitude is improbable with the landing gear extended and the propeller windmilling; (3) in no case should the airspeed be allowed to fall below the intentional one engine inoperative speed, even though altitude is lost, since this speed will always provide a better chance of climb, or a smaller altitude loss, than any lesser speed; and (4) if the requirement for an immediate climb is not present, allow the airplane to accelerate to the one engine inoperative best rate-of-climb speed with wing flaps up as this is the optimum climb speed and will always provide the best chance of climb or least altitude loss.

WARNING

THE PROPELLER ON THE INOPERATIVE ENGINE MUST BE FEATHERED, LANDING GEAR RETRACTED AND WING FLAPS UP OR CONTINUED FLIGHT MAY BE IMPOSSIBLE.

One engine inoperative procedures should be practiced to better prepare the pilot for actual engine inoperative emergencies. The pilot should be very familiar with the location of all controls necessary to complete an emergency shutdown and the securing procedure. Practice procedures are in Section 4.

ENGINE FAILURE IN FLIGHT (Speed Below V_{MCA})**1. Power Levers - RETARD to stop turn.****NOTE**

Autofeather will be inactivated if engine still has oil pressure.

2. Aileron and Rudder - **AS REQUIRED** toward operative engine to maintain straight-ahead flight.

WARNING

NORMALLY, THE BANK ANGLE REQUIRED WILL BE 5 DEGREES OR LESS; HOWEVER, INCREASE THE BANK ANGLE AS REQUIRED TO MAINTAIN STRAIGHT-AHEAD FLIGHT.

3. Pitch Attitude - **LOWER NOSE** to accelerate above 90 KIAS.
4. Accomplish procedures for Engine Failure in Flight (Speed above V_{MCA}).

ENGINE FAILURE IN FLIGHT (Speed above V_{MCA})

1. Inoperative Engine - **DETERMINE**. Idle engine same as idle foot; also, torque, ITT and N_g will be low.
2. Inoperative Engine Power Lever - **RETARD**.
3. Inoperative Engine Propeller - **FEATHER**.
4. Operative Engine - **ADJUST**.

NOTE

Power above FLIGHT IDLE may be required on the operating engine to maintain gyro pressure in the green arc.

5. Landing Gear - **UP**.
6. Airspeed - **108 KIAS** minimum.
7. Wing Flaps - **UP**.
8. If airstart is warranted, refer to AIRSTART procedure this section.

CAUTION

AIRSTART IS NOT NORMALLY RECOMMENDED IF REASON FOR FAILURE IS UNKNOWN OR IF ENGINE STOPPAGE WAS DUE TO A MALFUNCTION WHICH COULD CREATE A HAZARDOUS SITUATION IF A RESTART IS ATTEMPTED.

9. If airstart is not warranted, refer to ENGINE SECURING procedure this section.

BOTH ENGINES FAIL IN FLIGHT

NOTE

● *By design, the engines are totally independent of each other with the exception of drawing fuel from the same tank during crossfeeding. Fuel starvation or contamination would therefore be suspect.*

● *Depending upon the circumstances and the amount of available altitude at the time of occurrence, the pilot may choose to configure the airplane for maximum glide and attempt airstarts, or he may prepare for an immediate landing.*

● *Electrical power available will be limited to the amount of energy contained in the battery. Hydraulic gear operation may not be available.*

If Insufficient Altitude Exists to Permit Airstarts:

- 1. Refer to LANDING WITHOUT POWER procedures.**

If Sufficient Altitude Exists to Permit Airstarts:

1. Propellers - **DO NOT FEATHER** if airstart is attempted.
2. Airstarts - **ATTEMPT**, refer to **AIRSTART-STARTER ASSIST** procedures.
3. If Airstarts Fail:
 - a. Propellers - **FEATHER**.
 - b. Airspeed - **125 KIAS** (refer to Figure 3-1 Maximum Glide).
 - c. Refer to **LANDING WITHOUT POWER** procedures.

NOTE

If time permits, advise ATC and squawk 7700. Passenger advisory lights should be on and loose items in the cabin should be secured. Review the Emergency Exit Window Opening procedures. Fasten seat belts and shoulder harnesses.

ENGINE SECURING PROCEDURE

1. **Autofeather - OFF.**
2. **Power Lever - FLIGHT IDLE.**
3. **Propeller Control Lever - FEATHER.**
4. **Fuel Control Lever - CUTOFF.**
5. Fuel Crossfeed Selector - OFF if fire hazard exists.
6. Fuel Auxiliary Boost Pump - OFF if fire hazard exists.
7. Cowl Flap - CLOSED.
8. Propeller Synchrophaser - OFF.
9. Generator - OFF.
10. Electrical Load - REDUCE if necessary and MONITOR.

AIRSTART**STARTER ASSIST (Preferred Procedure)**

THE PILOT SHOULD DETERMINE THE REASON FOR ENGINE FAILURE BEFORE ATTEMPTING AN AIRSTART.

1. Electrical Load - REDUCE.
2. Air Conditioner - OFF.
3. Windshield Anti-Ice - OFF.
4. Autofeather - OFF.
5. Power Lever - One inch forward of FLIGHT IDLE.
6. Propeller Control Lever - Forward of FEATHER.
7. Fuel Control Lever - CUTOFF.
8. Fuel Quantity - CHECK.
9. Fuel Crossfeed Selector - OFF.
10. Fuel Auxiliary Boost Pump - ON.
11. Inoperative Engine Generator - OFF.
12. Operative Engine - REDUCE ITT to 650 degrees if practical.
13. Airspeed - 100 KIAS minimum.
14. Altitude - 20,000 feet maximum.
15. Start Switch - START; Check ignition light on.
16. Fuel Control Lever - RUN above 12 percent N_g .

17. ITT and N_g - MONITOR (1090 degrees Celsius maximum)

NOTE

If rise in N_g and ITT are not indicated within 10 seconds, place fuel control lever to CUTOFF and abort start. Refer to ENGINE SECURING CHECKLIST. Fuel control may be periodically moved to CUTOFF then back to RUN if over-temperature tendencies are encountered.

18. Start Switch - OFF N_g 52 percent or above.

19. Fuel Auxiliary Boost Pump - OFF MOMENTARILY, then NORMAL.

20. Propeller Control Lever - AS DESIRED.

21. Power Lever - AS DESIRED.

22. Generator - ON.

NOTE

After being reset, generators may take up to 15 seconds to come on line.

23. Electrical Equipment - AS REQUIRED.

NO STARTER ASSIST



THE PILOT SHOULD DETERMINE THE REASON FOR ENGINE FAILURE BEFORE ATTEMPTING AN AIRSTART.

1. Autofeather - OFF.
2. Power Lever - One inch forward of FLIGHT IDLE.
3. Propeller Control Lever - Forward of FEATHER.
4. Fuel Control Lever - CUTOFF.
5. Fuel Quantity - CHECK.
6. Fuel Crossfeed Selector - OFF.
7. Fuel Auxiliary Boost Pump - ON.
8. Inoperative Engine Generator - OFF.
9. Ignition Switch - ON, check light on.
10. Airspeed - 100 KIAS minimum (140 KIAS if feathered).
11. Altitude - 20,000 feet maximum (15,000 feet if feathered).

12. Fuel Control Lever - RUN (After N_g stabilizes).
13. ITT and N_g - MONITOR (1090 degrees Celsius maximum)

NOTE

●If rise in N_g and ITT are not indicated within 10 seconds, place fuel control lever to CUTOFF and abort start. Refer to ENGINE SECURING CHECKLIST.

●Emergency airstarts may be attempted below 10 percent N_g and outside the normal airspeed envelope, but ITT should be closely monitored. Fuel control lever may be periodically moved to CUTOFF then back to RUN if overtemperature tendencies are encountered.

●Do not attempt an air start with 0 percent N_g

14. Ignition Switch - NORMAL after N_g stabilizes above 52 percent.
15. Power Control Lever - AS DESIRED.
16. Power Lever - AS DESIRED.
17. Generator - ON.

NOTE

After being reset, generators may take up to 15 seconds to come on line.

18. Electrical Equipment - AS REQUIRED.
19. Fuel Auxiliary Boost Pump - OFF momentarily, then NORMAL.

NOTE

If N_g has not dropped below 50 percent on flame out, an immediate relight may be attempted by retarding the power lever to flight idle and turning on the ignitors. Do not attempt an air start if the engine stoppage was caused by a known engine malfunction which might make an attempted relight dangerous.

SMOKE AND FIRE

ENGINE FIRE DURING GROUND OPERATIONS (Sufficient Runway Remaining to Stop)

- 1. Power Levers - GROUND IDLE.**
- 2. Brakes - AS REQUIRED.**
- 3. Fuel Control Levers - CUTOFF.**
- 4. Fuel Crossfeed Selector - OFF.**
- 5. Illuminated Fire Warning**
Light - PUSH to disable the generator, close the bleed air firewall and fuel shutoff valves and ARM fire bottle (if installed).
- 6. Illuminated Fire Extinguisher**
Armed Light - PUSH (if installed).
- 7. Emergency Assistance - REQUEST (if warranted).**
- 8. Battery Switch - OFF.**
- 9. As Soon As Practical - EVACUATE.**

CABIN FIRE DURING GROUND OPERATIONS

- 1. Power Levers - GROUND IDLE.**
- 2. Brakes - AS REQUIRED.**
- 3. Fuel Control Levers - CUTOFF.**
- 4. Emergency Assistance - REQUEST (if warranted).**
- 5. Battery Switch - OFF.**
- 6. Portable Fire Extinguisher - USE as required.**
- 7. As Soon As Practical - EVACUATE.**

INFLIGHT WING OR ENGINE FIRE

- 1. Power Lever Affected Engine - FLIGHT IDLE.**
- 2. Propeller Control Lever Affected Engine - FEATHER.**
- 3. Fuel Control Lever Affected Engine - CUTOFF.**
- 4. Fuel Auxiliary Boost Pump Affected Engine - OFF.**
- 5. Illuminated Fire Warning**
Light - PUSH to disable the generator, close the bleed air firewall and fuel shutoff valves and ARM fire bottle (if installed).
- 6. Illuminated Fire Bottle Light - PUSH (if installed).**

NOTE

Power above FLIGHT IDLE may be required on the operating engine to maintain gyro pressure in the green arc.

7. Fuel Crossfeed Selector - OFF.
8. Engine Securing Procedure - COMPLETE.
9. As Soon As Practical - LAND and EVACUATE.

INFLIGHT CABIN ELECTRICAL FIRE OR SMOKE

OPENING THE FOUL WEATHER WINDOWS OR EMERGENCY EXIT WINDOW WILL CREATE A DRAFT IN THE CABIN AND MAY INTENSIFY A FIRE.

If Source Is Known:

1. **Oxygen - Use as required (If installed).**
2. **Faulty Equipment - OFF.**
3. **Fire - EXTINGUISH.**
4. **Smoke Removal Procedure - INITIATE if warranted.**
5. As Soon As Practical - LAND.

If Source of Fire or Smoke is Unknown:

1. **Oxygen - USE as required (if installed).**
2. **Nonessential Equipment - OFF.**
3. **Smoke Removal Procedure - INITIATE if warranted.**
4. If fire or smoke ceases, land as soon as practical.
5. If fire or smoke persists:
 - a. Fuel Crossfeed Selector - OFF.
 - b. Battery and Generators - OFF.

NOTE

Without electrical power all electrically operated gyros and engine instruments, fuel boost pumps, annunciator lights, wing flaps, normal landing gear extension and all avionics will be inoperative.

- c. Fire - EXTINGUISH.
6. If fire or smoke still persists, land as soon as possible.
7. If fire or smoke decreases and if possible, maintain VFR and land as soon as practical.

8. If unable to maintain VFR:
 - a. Circuit Breakers - PULL.
 - b. Battery - ON.
 - c. Generators - ON one at a time.
 - d. Essential Circuit Breakers - PUSH one at a time; then, pause to check for evidence of smoke.
 - e. Faulty Equipment - OFF.
 - f. Fire - EXTINGUISH.
 - g. Unaffected Essential Equipment - AS REQUIRED.
9. As Soon As Practical - LAND.

SMOKE REMOVAL

1. Source of Smoke - IDENTIFY and ELIMINATE.
2. Cabin Divider Curtain - OPEN (If installed).
3. Use of Supplemental Oxygen - AS REQUIRED (If installed).
4. If Source of Smoke Cannot be Eliminated:
 - a. Emergency Descent - INITIATE (as required).
 - b. Cabin Air Controls - PULL Ram Air Control Knob, PUSH knob if intensity of smoke increases.
5. As Soon As Practical - LAND.

SUPPLEMENTARY INFORMATION CONCERNING AIRPLANE FIRES

With the use of modern installation techniques and material, the probability of an airplane fire occurring in your airplane is extremely remote. However, in the event a fire is encountered, the following information will be helpful in dealing with the emergency as quickly and safely as possible.

The preflight checklist is provided to aid the pilot in detecting conditions which could contribute to an airplane fire. As a fire requires both fuel and an ignition source, close preflight inspection should be given to the engine compartment and wing leading edge and lower surfaces. Leaks in the fuel system, oil system, or exhaust system can lead to a ground or inflight fire.

NOTE

Flight should not be attempted with known fuel, oil or exhaust leaks. The presence of fuel, unusual oil or exhaust stains may be an indication of system leaks and should be corrected prior to flight.

If an airplane fire is discovered on the ground or during takeoff, but prior to committed flight, the airplane is to be landed and/or stopped and the passengers and crew evacuated as soon as practical.

Fires originating in flight must be controlled as quickly as possible in an attempt to prevent major structural damage. The fuel boost pumps, on applicable engine, should be turned off and the emergency crossfeed selector to OFF to reduce pressure on the total fuel system. The engine on the wing in which the fire exists should be shut down and the F/W shutoff switch activated even though the fire may not have originated in the fuel system. Descent for landing should be initiated immediately.

Opening the emergency exit or foul weather windows produces low pressure in cabin. To avoid drawing the fire into the cabin, the emergency exit and foul weather windows should be kept closed. This condition is aggravated with the landing gear and flaps extended. Therefore, the pilot should lower the landing gear as late in the landing approach as possible. A no wing flap landing should also be attempted if practical.

Fire or smoke in the cabin should be controlled by identifying and shutting down the faulty system. Normally the bleed air system will remove smoke from the cabin; however, if the smoke is intense, it may be necessary to initiate the bleed air contamination procedure presented in this section. When the smoke is intense, the pilot may choose to expel the smoke through the foul weather windows. The foul weather windows should be closed immediately if the fire becomes more intense when the windows are opened.

EMERGENCY DESCENT

PREFERRED PROCEDURE

1. Power Levers - **FLIGHT IDLE.**
2. Propeller Control Levers - **FORWARD.**
3. Wing Flaps - **UP.**
4. Landing Gear - **UP.**
5. Airspeed - **229 KIAS/0.52 Mach.**

IN TURBULENT ATMOSPHERIC CONDITIONS

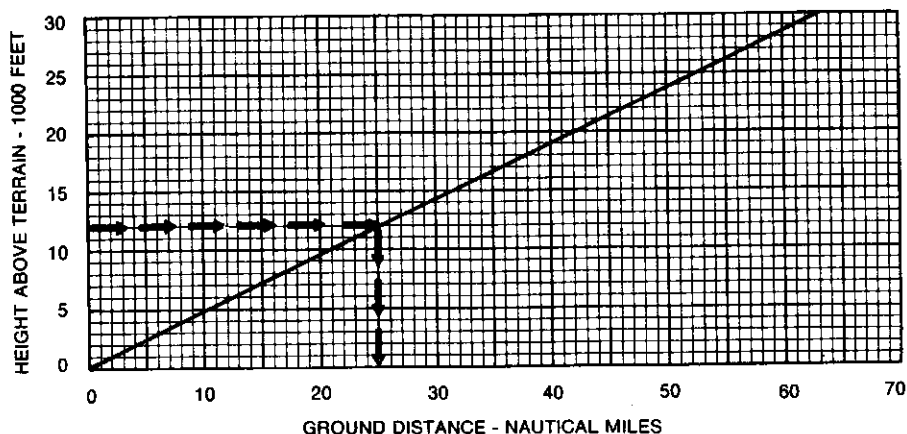
1. Power Levers - **FLIGHT IDLE.**
2. Propeller Control Levers - **FORWARD.**
3. Wing Flaps - **APPR below 200 KIAS.**
4. Landing Gear - **DOWN.**
5. Wing Flaps - **LAND below 180 KIAS.**
6. Airspeed - **180 KIAS.**

GLIDE

In the event of an all engines failure condition, maximum gliding distance can be obtained by feathering both propellers, closing cowl flaps and maintaining approximately 125 KIAS with landing gear and wing flaps up.

CONDITIONS:

1. Landing Gear - Up.
2. Wing Flaps - Up.
3. Propellers - Feathered.
4. Cowl Flaps - Closed.
5. Best Glide Speed.
6. Zero Wind.



EXAMPLE:

Weight - 8500 Pounds.

Height Above Terrain - 12,000 Feet.

Ground Distance - 25 Nautical Miles.

60856016

Figure 3-1
MAXIMUM GLIDE

LANDING EMERGENCIES

Any time the pilot is faced with a precautionary or forced landing, or one where landing gear abnormalities are present, he must make decisions based on the circumstances present and his complete understanding of the airplane.

Of a general nature, in the case of forced landings, the following should be considered prior to landing. First, select a suitable landing site. Airplane control enroute must be maintained regardless of the distractions present. If time permits, advise ATC and squawk 7700. Passenger advisory lights should be on and loose items in the cabin should be secured. Review the Emergency Exit Procedures and secure seat belts and shoulder harnesses.

PRECAUTIONARY OR FORCED LANDING WITH POWER

1. Landing Site - CHECK. Fly over site 120 KIAS with APPR flaps.
2. Landing Gear - DOWN or UP (at pilot's discretion).
3. Cabin Heat Source Select - OFF.
4. Nonessential Equipment - OFF.
5. Fuel Crossfeed Selector - OFF.
6. Fuel Auxiliary Boost Pumps - OFF.
7. Emergency Exit Windows - OPEN if passenger is available.
8. Landing - INITIATE (in nose high attitude).
 - a. Fuel Control Levers - CUTOFF after touchdown.
 - b. Battery - OFF.

LANDING WITHOUT POWER

1. Flaps - Approach (When Landing Site is Assured).
 - a. Fuel Control Levers - CUTOFF.
 - b. Wing Flaps - APPR.
 - c. Starter Switch - MOTOR. OFF after wing flaps reach the APPR position.
2. Engine Securing Procedure - COMPLETE.
3. Nonessential Equipment - OFF.
4. Fuel Crossfeed Selector - OFF.
5. Landing Gear - DOWN (The pilot may elect to land gear up depending on terrain).
 - a. Landing Gear Switch - DOWN.
 - b. LDG GEAR System Circuit Breaker - PULL.
 - c. Emergency Gear Extension T-Handle - PULL below 130 KIAS, within gliding distance of field.

6. Battery Switch - OFF (Day).
7. Emergency Exit Windows - OPEN if passenger is available.
8. Approach - 110 KIAS with APPR FLAPS (125 KIAS with 0° flaps).
9. Landing - INITIATE (in nose high attitude).

LANDING WITH FLAT MAIN GEAR TIRE

If a blowout occurs during takeoff and the takeoff is continued, proceed as follows:

1. Landing Gear - LEAVE DOWN.

NOTE

Do not attempt to retract the landing gear if a main gear tire blowout occurs. The main gear tire may be distorted enough to bind the main gear strut within the wheel well and prevent later extension.

2. Fuel Crossfeed Selector - CROSSFEED AS REQUIRED to burn off fuel from the tank over the defective tire. Do not exceed 300 pounds asymmetric fuel loading.

NOTE

Fuel should be used from this tank first, to lighten the load on the wing, prior to attempting a landing if inflight time permits. However, an adequate supply of fuel should be left in this tank so that it may be used during landing.

3. Fuel Crossfeed Selector - OFF.
4. If a crosswind landing is required, select a runway with a crosswind from the side opposite the defective tire.
5. Before Landing Checklist - COMPLETE.
6. In approach, align airplane with edge of runway opposite the defective tire, allowing room for a mild turn in the landing roll.
7. Land slightly wing-low on the side of inflated tire and lower nosewheel for positive steering.
8. Use full aileron in landing roll to lighten load on defective tire.

9. Apply brakes on the inflated tire to minimize landing roll and to maintain directional control.
10. Stop airplane to avoid further damage unless runway must be cleared for other traffic.

LANDING WITH FLAT NOSE GEAR TIRE

If a blowout occurs during takeoff and the takeoff is continued, proceed as follows:

1. Landing Gear - LEAVE DOWN.

NOTE

Do not attempt to retract the landing gear if a nose gear tire blowout occurs. The nose gear tire may be distorted enough to bind the nosewheel strut within the wheel well and prevent later extension.

2. Passengers and Baggage - **MOVE AFT** (remain within allowable center-of-gravity limits).
3. Approach - 110 KIAS with APPR wing flaps.
4. Landing Attitude - **NOSE HIGH** with power.
5. Nosewheel - **HOLD OFF** during landing roll.
6. Brakes - **MINIMUM** during landing roll.
7. Power Levers - **FLIGHT IDLE**.
8. Control Wheel - **FULL AFT** until airplane stops.
9. Taxiing - **MINIMIZE** to prevent further damage.

LANDING WITH DEFECTIVE MAIN GEAR

1. Fuel Crossfeed Selector - **AS REQUIRED** to burn off fuel from the tank over defective gear; feel for detent. Do not exceed 300 pounds asymmetric fuel loading.

NOTE

Fuel should be used from this tank first to lighten the load on the wing prior to attempting a landing, if in-flight time permits; however, an adequate supply of fuel should be left in the tank so that it may be used during landing.

2. Fuel Crossfeed Selector - **OFF**.

3. Select headwind or crosswind opposite defective gear.
4. Before Landing Checklist - COMPLETE.
5. Align airplane near the edge of runway opposite the defective landing gear.
6. Battery Switch - OFF (day).
7. Land wing low toward operative landing gear. Lower nosewheel immediately for positive steering.
8. Start a moderate ground loop into defective landing gear.
9. Fuel Controls - CUTOFF.
10. Use full aileron in landing roll to lighten the load on the defective gear.
11. Apply brakes only on the operative landing gear to hold desired rate of turn and shorten landing roll.
12. Fuel Auxiliary Boost Pumps - OFF.

LANDING WITH DEFECTIVE NOSE GEAR

1. Passenger and Baggage - MOVE AFT (remain within allowable center-of-gravity limits).
2. Landing Gear - DOWN.
3. Approach - 110 KIAS with APPR wing flaps.
4. Battery Switch - OFF.
5. Landing Attitude - NOSE HIGH with power.
6. Fuel Control Levers - CUTOFF.
7. Nosewheel - HOLD OFF during ground roll.

LANDING WITH POWER, LANDING GEAR RETRACTED

1. Cabin Heat Source Select Knob - OFF.
2. Nonessential Equipment - OFF.
3. Fuel Crossfeed Selector - OFF.
4. Fuel Auxiliary Boost Pumps - OFF.
5. Emergency Exit Windows - OPEN if passenger is available.
6. Approach - 110 KIAS with APPR wing flaps.
7. Wing Flaps - LAND when landing is assured.
8. Landing - INITIATE (in nose high attitude).

LANDING WITH WING FLAPS RETRACTED

1. Propeller Control Levers - FORWARD.
2. Fuel Crossfeed Selector - OFF.
3. Approach Speed - 125 KIAS.
4. Landing Gear - DOWN.

ENGINE INOPERATIVE LANDING

1. Fuel Balance - CHECK maximum of 300 pounds differential.
2. Fuel Crossfeed Selector - OFF.
3. Passenger Advisory Lights - AS REQUIRED.
4. Cowl Flaps - AS REQUIRED.
5. Altimeter - SET.
6. Seat Belts and Shoulder Harness - SECURE.
7. Propeller Control Lever - FORWARD.
8. Autofeather - OFF.
9. Wing Flaps - T.O.
10. Approach at 110 KIAS.
11. Landing Gear - LAND within gliding distance of field.
12. Rudder Trim - CENTER as power is reduced.
13. Wing Flaps - LAND when landing is assured.
14. Decrease speed below 100 KIAS only when landing is assured.
15. Air Minimum Control Speed - 90 KIAS.

WARNING

DO NOT RETARD POWER LEVER BELOW FLIGHT IDLE WHILE AIRBORNE.

NOTE

Power above FLIGHT IDLE may be required on the operating engine to maintain gyro pressure in the green arc.

16. Power Lever - GROUND IDLE after touchdown.
17. Nosewheel - LOWER GENTLY.

18. Brakes, Propeller Reverse
and Nosewheel Steering - AS REQUIRED.

CAUTION

IF NECESSARY, CAUTIOUSLY APPLY REVERSING AS REQUIRED ON THE OPERATING ENGINE. TO MAINTAIN DIRECTIONAL CONTROL, THE REVERSE THRUST IS COUNTERACTED BY OPPOSITE BRAKE AND RUDDER. IF RUNWAY BRAKING ACTION IS LESS THAN NORMAL DUE TO LOOSE GRAVEL, SOD SURFACE, SNOW, ICE OR RAIN, CAREFUL MODULATION OF POWER WILL BE REQUIRED TO MAINTAIN DIRECTIONAL CONTROL.

ENGINE INOPERATIVE GO-AROUND (Speed above 101 KIAS)

WARNING

LEVEL FLIGHT MAY NOT BE POSSIBLE FOR EXTREME COMBINATIONS OF WEIGHT, TEMPERATURE AND ALTITUDE.

1. Power Lever - ADVANCE to takeoff power while maintaining straight-ahead flight. Maintain 3 to 4 degrees bank with 1/2 ball slip into operative engine.
2. Wing Flaps - T.O.
3. Positive Rate-of-Climb - ESTABLISH at 102 KIAS.
4. Landing Gear - UP.
5. Climb to Clear Obstacles - 102 KIAS.
6. Airspeed - ACCELERATE to 108 KIAS.
7. Wing Flaps - UP.
8. Trim Tabs - ADJUST.
9. Cowl Flaps - AS REQUIRED.

DITCHING

1. Landing Gear - UP.
2. Approach - HEADWIND if high wind.
- PARALLEL to SWELLS if light wind and heavy swells.
3. Wing Flaps - LAND.
4. Power - AS REQUIRED (300 feet per minute rate-of-descent).
5. Airspeed - 100 KIAS minimum. Reduce airplane weight by fuel burnoff as much as practical.
6. Attitude - DESCENT ATTITUDE through touchdown. Do not flare.

NOTE

The airplane has not been flight tested in actual ditchings; thus, the above recommended procedure is based entirely on the best judgment of Cessna Aircraft Company.

SYSTEM EMERGENCIES**ENGINE EMERGENCY PROCEDURES****PROPELLER SYNCHROPHASER FAILURE**

1. Propeller Synchrophaser - OFF.

FUEL SYSTEM EMERGENCY PROCEDURES**Main Fuel Ejector and Fuel Auxiliary Boost Pump Failure (L or R FUEL PRESS LOW light illuminated)**

1. Fuel Crossfeed Selector - OFF.
2. Fuel Auxiliary Boost Pump - ON.
3. Fuel Auxiliary Boost Circuit Breaker - CHECK. Reset as required.
4. If FUEL PRESS LOW light remains illuminated:
 - a. Affected Fuel Auxiliary Boost Pump - OFF.
 - b. If FUEL PRESS LOW light goes out, refer to AUXILIARY BOOST PUMP FAILURE procedure.

5. IF FUEL PRESS LOW light still remains illuminated (confirmed dual failure):
 - a. Maintain coordinated flight.
 - b. Do not exceed ± 10 degrees pitch attitude.
 - c. Unusable fuel in the affected side is 150 pounds in level attitudes and 300 pounds in nose up or down attitude up to ± 10 degrees.
 - d. Crossfeed from opposite tank and/or suction feed as required to maximize fuel availability and control fuel balance. Descend as required to provide stable fuel flow indication on affected engine when suction feeding. Crossfeed is unavailable from affected tank.
 - e. As Soon As Practical - LAND.



WHEN CROSSFEEDING FROM OPPOSITE TANK, FUEL IMBALANCE WILL INCREASE RAPIDLY DUE TO THE 500-800 POUND PER HOUR RATE OF TRANSFER BETWEEN TANKS.

Fuel Transfer Ejector Pump Failure (L or R XFER PUMP FAIL Light Illuminated with fuel quantity greater than 35 pounds)

1. Fuel Crossfeed Selector - OFF (if applicable).
2. Fuel Auxiliary Boost Pump - ON.
3. Fuel Auxiliary Boost Circuit Breaker - CHECK. Reset as required.
4. If condition not rectified:
 - a. Maintain coordinated flight.
 - b. Maintain pitch attitude within ± 15 degrees.
 - c. Unusable fuel in the affected tank increases 20 pounds.

NOTE

● *Transfer failures caused by ejector transfer pump failure require limitation of climb pitch attitude (aft pump failure) or dive pitch attitude (forward pump failure) as determined by conditions which cause XFER PUMP FAIL Light illumination.*

● *If both the main ejector and auxiliary boost pumps are inoperative refer to the MAIN EJECTOR AND AUXILIARY BOOST PUMP FAILURE procedure.*

NOTE

Fuel quantity indication at low fuel quantity with a transfer failure should be checked in level flight.

Fuel Auxiliary Boost Pump Failure (L or R AUX PUMP ON and L or R FUEL PRESS LOW light illuminated or L or R AUX PUMP ON Light goes out when fuel auxiliary boost pump should be operating)**NOTE**

Loss of electrical power to the fuel auxiliary boost pump switching circuits will disable the auxiliary pressure switch and the AUX PUMP ON light. The pilot should therefore monitor continued illumination of the AUX PUMP ON Light in conditions where auxiliary boost pump operation is required.

1. Fuel Crossfeed Selector - OFF.

NOTE

Crossfeed is unavailable from the tank with the failed pump. Crossfeed is available from the opposite tank; however, fuel quantity and balance must be monitored carefully due to the 500-800 pounds per hour rate of fuel transfer from the feeding tank to the nonfeeding tank.

2. Affected Fuel Auxiliary Boost Pump - ON.
3. Affected Fuel Auxiliary Boost Circuit Breaker - CHECK. Reset as required.
4. If proper operation not restored:
 - a. Affected Fuel Auxiliary Boost Pump - OFF.
 - b. Check L or R FUEL PRESS LOW Light - OFF.
5. If using Aviation Gasoline - Maintain 18,000 feet altitude or below if feasible.
6. If corresponding XFER PUMP FAIL Light becomes illuminated (below approximately 230 pounds per tank) - Refer to TRANSFER EJECTOR PUMP FAILURE procedure.

ELECTRICAL SYSTEM EMERGENCY PROCEDURES

Generator Failure Light Illuminated (L or R GEN OFF)

1. Electrical Load - **DECREASE** as required to prevent discharge of the battery.
2. GEN CONTROL Circuit Breakers - **CHECK**. Reset as required.
3. Affected Generator - **RESET** then **ON**.

NOTE

After being reset, generators may take up to 15 seconds to come on line.

4. If Normal Generator Operation Does Not Occur:
 - a. Affected Generator - **OFF**.

Engine Start Light Remains Illuminated After Engine Start (L or R START)

1. Battery Switch - **OFF** to prevent motoring the affected start motor during shutdown.
2. Auxiliary Power Unit - **DISCONNECT** (if connected).
3. Fuel Control Lever - **CUTOFF**.
4. Engine Shutdown - **COMPLETE**. (Refer to **SHUTDOWN** in Normal Procedures.)

The L or R ENG START light illuminates any time the start relay is closed. This relay provides current to the appropriate starter motor. Failure of the start relay to open will preclude a normal engine shutdown and will result in a starter/generator failure if the engine is shut down in flight.

Battery Overheat Light Illuminated (BATT O'HEAT)

If Light Illuminates Continuously:

1. **Battery Switch - OFF.**
2. Left Ammeter - CHECK while holding BATT/L GEN switch in BATT position.
 - a. If ammeter shows zero indication:
 - (1) Light will extinguish when battery temperature decreases.
 - b. If ammeter shows up scale indication:
 - (1) Generators - OFF.

NOTE

Without electrical power all electrically operated gyros and engine instruments, fuel boost pumps, annunciator lights, wing flaps, normal landing gear extension and all avionics will be inoperative.

- (2) All Electrical System Switches - OFF.
- (3) After 5 minutes:
 - (a) Either Generator - ON.
 - (b) Left Ammeter - CHECK while holding BATT/L GEN switch in BATT position.
 - 1) If ammeter shows up scale indication:
 - a) Generator - OFF.
 - 2) If ammeter shows zero indication:
 - a) Generators - ON.
 - b) Reinstate electrical systems as required.
 - c) Monitor overheat lights.
3. As Soon As Practical - LAND.

If Light Begins Flashing:

1. Battery Switch - CHECK OFF.
2. Generators - OFF.

NOTE

Without electrical power all electrically operated gyros and engine instruments, fuel boost pumps, annunciator lights, wing flaps, normal landing gear extension and all avionics will be inoperative.

3. All Electrical Systems Switches - OFF.

4. After 5 Minutes:
 - a. Either Generator - ON.
 - b. Left Ammeter - CHECK while holding BATT/L GEN switch in BATT position.
 - (1) If ammeter shows up scale indication:
 - (a) Generator - OFF.
 - (2) If ammeter shows zero indication:
 - (a) Generators - ON.
 - (b) Reinstate electrical systems as required.
 - (c) Monitor overheat lights.
5. As Soon As Practical - LAND.

NOTE

If the light begins flashing (battery thermal runaway indication) without first a steady (battery overheat) warning, the problem may be in the indicator circuit. In any event, the battery and generators should be turned off.

Inverter Failure Light Illuminated (AC FAIL)

1. If Optional Dual Inverter Installed:
 - a. Inverter Switch - Select other inverter.

NOTE

If single inverter installed and AC FAIL light illuminates, AC power will be unavailable to the ADF, autopilot, some optional radars and attitude gyros.

HYDRAULIC SYSTEM EMERGENCIES

Hydraulic Pressure Light Illuminated After Wing Flaps or Landing Gear Retraction or Extension (HYD PRESS ON)

NOTE

The HYD PRESS ON annunciator light is illuminated when the landing gear or wing flaps are in an operational cycle. If the light remains illuminated after the landing gear and/or wing flaps have reached their selected positions, proceed with the following steps.

1. Airspeed - 130 KIAS or less.

2. LDG GEAR and FLAP CONTROL
System Circuit Breakers - CYCLE to determine which system is causing the malfunction.
3. Landing Gear and/or Wing Flap Switch - RAPIDLY RECYCLE.



IF THE HYD PRESS ON ANNUNCIATOR LIGHT CANNOT BE EXTINGUISHED, LAND AS SOON AS PRACTICAL TO PREVENT DAMAGE TO HYDRAULIC SYSTEM AND/OR COMPONENTS.

4. If Light Fails to go Out and Wing Flaps are Causing the Malfunction:
 - a. Wing Flaps Switch - MOVE slightly away from selected position.
 - b. If Light Remains Illuminated:
 - (1) Wing Flaps Switch - SELECT desired position.
 - (2) FLAP CONTROL System
Circuit Breaker - PULL after wing flaps reach desired position.
5. If Light Fails to go Out and Landing Gear is Causing the Malfunction:
 - a. Landing Gear Switch - RAPIDLY RECYCLE.
 - b. If Light Remains Illuminated:
 - (1) Landing Gear Switch - SELECT desired position.
 - (2) LDG GEAR System
Circuit Breaker - PULL after landing gear reaches desired position.
6. Before Landing - RESET applicable circuit breaker.

NOTE

Normal landing gear or wing flap operation will not be available until the applicable circuit breaker is reinstated.

Landing Gear Down and Locked Light Illuminated With Gear Handle Up and Hydraulic Pressure Light Out

1. Perform "LANDING GEAR WILL NOT EXTEND HYDRAULICALLY" procedure this section.

NOTE

Failure of any one of the three down lock switches in the down position may result in an indication of that gear not locking down during a gear down cycle if the other two gears lock down first. The down and locked light for the affected gear may remain on continually regardless of actual gear position.

Landing Gear Will Not Extend Hydraulically

1. Airspeed - 130 KIAS or less.

NOTE

As low an airspeed as practical is recommended as a lower airspeed will decrease the airloads on the nose gear during extension, thereby ensuring the greatest probability of gear extension.

2. Landing Gear Switch - DOWN.
3. LDG GEAR Systems Circuit Breaker - PULL.
4. Emergency Gear Extension T-Handle - PULL.
5. Gear Down Lights - ON; Unlocked Light - OFF.
6. If Main Gear Does Not Lock Down - YAW AIRPLANE. Airloads will lock main gear down if up locks have released.
7. Gear Warning Horn - CHECK.
8. As Soon As Practical - LAND.



THE LANDING GEAR CANNOT BE RETRACTED IN-FLIGHT, ONCE THE EMERGENCY GEAR EXTENSION T-HANDLE HAS BEEN PULLED. GROUND SERVICING IS REQUIRED.

Landing Gear Will Not Retract Hydraulically

1. Landing Gear Switch - DOWN.
2. Gear Down Lights - ON; Unlocked Light - OFF.
3. Gear Warning Horn - CHECK.
4. As Soon As Practical - LAND.

ENVIRONMENTAL SYSTEMS EMERGENCIES**Wing Overheat Light Illuminated (L or R WING O'HEAT)****NOTE**

Bleed air flow from the affected wing will automatically be terminated when WING O'HEAT light illuminates.

1. Audibly verify bleed air flow is terminated.
2. If Doubt Exists Regarding Bleed Air Termination:
 - a. Cabin Heat Auto/Manual Control - MANUAL.
 - b. Cabin Heat Manual Temperature Switch - WARMER for 10 seconds.
 - c. Cabin Heat Source Selector - SELECT the affected engine momentarily. No heat indicates the bleed air flow has been terminated.
3. If WING O'HEAT Light Does not go Out in Two Minutes:
 - a. Affected Engine - SECURE (refer to Engine Securing Procedure).
 - b. Operative Engine - ADJUST.

NOTE

Power above FLIGHT IDLE may be required on the operating engine to maintain gyro pressure in the green arc.

- c. Trim Tabs - ADJUST to maintain bank toward operative engine.
- d. Electrical Load - DECREASE if required to prevent battery discharge.
- e. Fuel Crossfeed Selector - AS REQUIRED to maintain fuel balance within 300 pounds. Do not crossfeed if fire hazard exists.
- f. As Soon As Practical - LAND.

Air Duct Overheat Light Illuminated (AIR DUCT O'HEAT)

1. Temperature Control Knob - MANUAL (Full counterclockwise).
2. Manual Warmer/Cooler Switch - COOLER for approximately 15 seconds.
3. Ram Air Control - PUSH.
4. Cockpit/Cabin Air Control - PULL.
5. Cabin Air Defrost Knob - PULL.
6. If AIR DUCT O'HEAT light does not go out in two minutes:
 - a. Cabin Heat Source Select Switch - OFF.
 - b. As Soon As Practical - LAND.

Bleed Air Contamination

1. Cabin Heat Source Select - OFF.
2. Ram Air Knob - PULL to clear cockpit.
3. Cabin Heat Source Select - LH then RH (to isolate source).

NOTE

Air contamination originating from both engines would not normally be anticipated. Leave source selector in each position 2 minutes to determine if smoke is decreasing. If one selector position eliminates smoke generation, continue in that position.

4. If air contamination continues:
 - a. If supplementary oxygen is available:
 - (1) Oxygen Knob - PULL ON.
 - (2) Assure each occupant is using oxygen.
 - b. Smoke Removal Checklist - COMPLETE.

OXYGEN SYSTEM FAILURE (IF INSTALLED)

1. Maintain altitude below 10,000 feet.

ICE PROTECTION SYSTEMS EMERGENCIES**Inadvertent Icing Encounter**

1. Ignition Switches - ON.
2. Engine Inertial Separator Switches - BYPASS.



IF THE ENGINE INERTIAL SEPARATOR IS NOT POSITIONED TO BYPASS, MOISTURE MAY COLLECT UNDER THE ENGINE INLET SCREEN AND FREEZE. SUBSEQUENTLY, THIS ICE MAY SEPARATE AFTER ENCOUNTERING HIGHER OUTSIDE TEMPERATURES WHICH COULD RESULT IN ENGINE DAMAGE.

3. Pitot/Static Heat Switches - ON.
4. Stall Heat Switches - ON.
5. Propeller Deice Switches - ON.
6. Ignition Switches - OFF after 5 minutes operation.
7. Leave icing conditions as soon as possible.

Engine Inertial Separator System Failure

1. Inertial Separator - BYPASS (monitor inertial separator lights).
2. Check proper operation by noting torque drop and slight rise in ITT.
3. If Inertial Separator Fails in the NORMAL Mode - Turn ignition switches ON and leave icing conditions as soon as possible.

Pitot/Static System Failure

1. Pitot/Static Heat Switches - CHECK ON.
2. Pilot's and Copilot's Instruments - DETERMINE which instruments are functioning normally.

NOTE

Initiate climb or descent with fixed power and watch for appropriate indication on rate-of-climb, airspeed and altimeter. If the deice heater has an open circuit, no amperage change will be seen when switch is moved.

3. Complete flight on the operative instruments.

NOTE

Copilot's pitot/static system is totally separate from the pilot's system.

Propeller Deice Failure

If uneven deicing of the propeller is indicated by excessive vibration:

1. Propeller Control Lever - EXERCISE then return to CRUISE.
2. Propeller Ammeter - CHECK for proper operation by periodic fluctuations within the green arc.
3. If ammeter reading is below the green arc, indicating the propeller blades may not be deicing uniformly:
 - a. Propeller Deice Switch - OFF for affected propeller.
4. Leave icing conditions as soon as possible.

Boot Operation With One Engine Inoperative

1. Power Lever - SET (above 65 percent N_g during deice boot actuation.

NOTE

To provide sufficient deice boot pressure during deice boot actuation, the operating engine should be above 65 percent N_g . Power above FLIGHT IDLE may be required on the operating engine to maintain gyro pressure in the green arc.

AVIONICS BUS FAILURE

1. Applicable Avionics Bus Switch Breaker - Reset after cooling 3 minutes.
 - a. If Switch Breaker Trips Again - DO NOT RESET.
2. With L AVIONICS BUS Switch Breaker Off. The following Avionics will be inoperative:

| | | |
|----------------|----------------|--------------------|
| a. COM 1 | f. ADF 1 | k. RMI 1 (OPT) |
| b. NAV 1 | g. DME 1 | l. RAD ALTM (OPT) |
| c. G/S 1 (OPT) | h. MKR 1 (OPT) | m. ALT ALERT (OPT) |
| d. AUD 2 (OPT) | i. COM 3 (OPT) | n. RADAR (OPT) |
| e. XPDR 1 | j. R-NAV (OPT) | o. TELEPHONE (OPT) |
3. With R AVIONICS BUS Switch Breaker Off. The following Avionics will be inoperative:

| | | |
|----------------|-----------------|-------------------|
| a. COM 2 | e. XPDR 2 (OPT) | i. RMI 2 (OPT) |
| b. NAV 2 | f. ADF 2 (OPT) | j. AUTOPILOT COMP |
| c. G/S 2 (OPT) | g. DME 2 (OPT) | k. AUTOPILOT ACT |
| d. AUD 1 | h. MKR 2 (OPT) | l. AUTOPILOT Y/D |

EMERGENCY EXITS**Emergency Exit Window Opening (Refer to Figure 3-2)**

1. Emergency Release Handle - ROTATE FORWARD.
2. Emergency Exit Window - PUSH OUT and UP until the uplock brace holds the window open.

Cabin Door, Crew Door or Emergency Exit Not Secured Light Illuminated (DOOR NOT LOCKED)

1. Airspeed - REDUCE AS REQUIRED.
2. Passenger Advisory Lights - AS REQUIRED.

3. As Soon As Practical - LAND.

WARNING

DO NOT ATTEMPT TO CHECK THE SECURITY OF THE CABIN DOOR, CREW DOOR OR EMERGENCY EXIT. REMAIN AS FAR FROM THE DOOR AS POSSIBLE WITH SEAT BELTS SECURELY FASTENED UNTIL LANDING IS COMPLETED.

NOSE BAGGAGE DOOR OPEN ON TAKEOFF

If a baggage door is left unlatched, it may open as the nose is raised on takeoff. The door will not hit a propeller nor will there be any unusual handling characteristics. If sufficient runway remains for a safe abort, the aircraft should be stopped. If the decision is made to continue the takeoff, maintain airspeed below 120 KIAS and return for landing as soon as practical. Avoid lowering the nose abruptly which could throw loose objects out of the compartment.

EMERGENCY LOCATOR TRANSMITTER RESCUE PROCEDURES

Before Landing

1. VHF COM - SET 121.5 MHz or known ATC frequency and transmit May Day calls for assistance if time permits.

After Landing

1. Plug Button - REMOVE (located on side of tailcone).
2. Emergency Locator Transmitter Switch - ON.

After Rescue

1. Emergency Locator Transmitter Switch - OFF.

ENCODING ALTIMETER FAILURE (Warning Flag Showing)

1. ALT Circuit Breaker - CHECK IN.
2. If warning flag is still showing, use the standby barometric altimeter.

TRANSPONDER PROCEDURES FOR EMERGENCY SITUATIONS

Emergency Signal Transmission

1. Function Switch - ON.
2. Reply-Code Selector Switches - SELECT code 7700.

Loss-of-Communications Signal Transmission

1. Function Switch - ON.
2. Reply-Code Selector Switches - **SELECT** code 7700; **WAIT** 1 minute, **THEN SELECT** code 7600; **WAIT** 15 minutes. Repeat procedures at same intervals for remainder of flight.

Hijacked Signal Transmission

1. Function Switch - ON.
2. Reply-Code Selector Switches - **SELECT** Code 7500.

TOTAL LOSS OF COMMUNICATIONS

In the event that the audio panel or a microphone malfunctions such that COM operation cannot be performed on COM 1, COM 2 or COM 3, proceed as follows:

1. Employ an alternate microphone.

If the Problem Continues:

2. Function Selector Switch - **EMER COM**. Speaker operation will be inoperative in all modes.
3. Employ headsets.
4. Set the desired frequency on COM 1 and proceed with communication on that COM only.
5. Set receiver selector switches to HDST for receivers to be monitored (NAV, MKR, ADF or DME). A reduction in normal amplitude will be experienced while operating in emergency mode.

NOTE

If a second audio panel is installed, the emergency function of the second panel will be on COM 2.

If Communications Cannot Be Reestablished:

6. Refer to Transponder Procedures for Emergency Situations.
7. Comply with ATC procedures for loss of communications.

ELECTRIC ELEVATOR TRIM RUNAWAY

1. Control Wheel - **OVERPOWER** as required.
2. AP/TRIM Disconnect Switch - **DISCONNECT** immediately.
3. Manual Elevator Trim - **AS REQUIRED**.

NOTE

After the electric trim has been disconnected and the emergency is over, pull the electric trim (ELEV TRIM) circuit breaker. Do not attempt to use the electric elevator trim system until ground maintenance has been completed.

SPINS

Intentional spins are not permitted in this airplane. Should a spin occur the following recovery procedures should be employed:

1. Power Levers - **FLIGHT IDLE**.
2. Ailerons - **NEUTRALIZE**.
3. Rudder - **HOLD FULL RUDDER** opposite the direction of rotation.
4. Control Wheel - **FORWARD BRISKLY**. 1/2 turn of spin after applying full rudder.
5. Inboard Engine - **INCREASE POWER** to slow rotation (if necessary).

After rotation has stopped:

6. Rudder - **NEUTRALIZE**.
7. Inboard Engine (If Used) - **DECREASE POWER** to equalize engines.
8. Control Wheel - **PULL** to recover from resultant dive. Apply smooth steady control pressure.

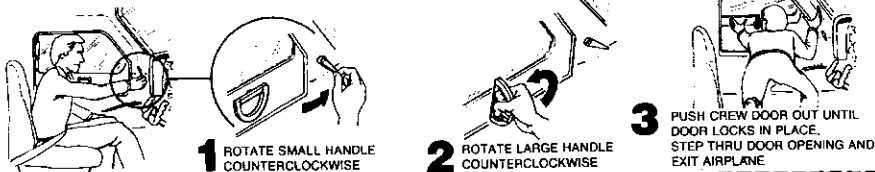
NOTE

The airplane has not been flight tested in spins, thus the above recommended procedure is based entirely on the best judgment of Cessna Aircraft Company.

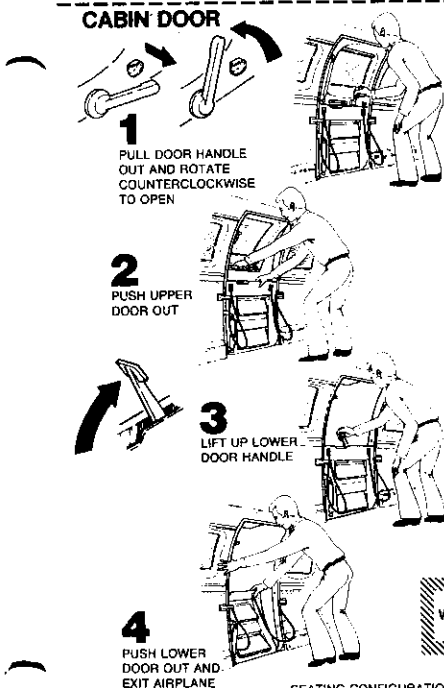
EMERGENCY INFORMATION

(WHEN EXITING, DO NOT TAKE ANY LUGGAGE WITH YOU)

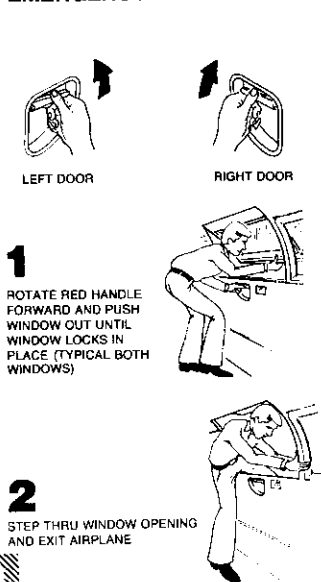
CREW DOOR



CABIN DOOR



EMERGENCY EXIT WINDOWS



WARNING:
WHEN EXITING AIRPLANE
AVOID PROPELLER.

SEATING CONFIGURATION SHOWN MAY NOT AGREE WITH YOUR AIRPLANE

Figure 3-2
EMERGENCY EXITS

(

(

**SECTION 4
NORMAL PROCEDURES**

TABLE OF CONTENTS

| | Page |
|--------------------------------------|------|
| INTRODUCTION | 4-3 |
| AIRSPEDS FOR NORMAL OPERATIONS | 4-3 |

NORMAL PROCEDURES ABBREVIATED CHECKLIST

| | |
|---|-------------------|
| PREFLIGHT INSPECTION | 4-4 |
| BEFORE ENGINE STARTING | 4-7 |
| ENGINE STARTING (Battery Start) | 4-8 |
| ENGINE STARTING (With External Power) | 4-8 |
| BEFORE TAXIING | 4-9 |
| TAXIING | 4-9 |
| BEFORE TAKEOFF | 4-9 |
| TAKEOFF | 4-10 |
| CLIMB | 4-10 |
| CRUISE | 4-10 |
| DESCENT | 4-11 |
| BEFORE LANDING | 4-11 |
| BALKED LANDING | 4-11 |
| AFTER LANDING | 4-12 |
| SHUTDOWN | 4-12 |
| POSTFLIGHT EMERGENCY LOCATOR TRANSMITTER CHECK | 4-12 |
| ENVIRONMENTAL SYSTEMS | 4-12 |
| Oxygen System | 4-12 |
| Heating and Ventilating Systems | 4-13 (4-14 blank) |

AMPLIFIED NORMAL PROCEDURES

| | |
|---|------|
| PREFLIGHT INSPECTION | 4-15 |
| BEFORE ENGINE STARTING | 4-17 |
| ENGINE STARTING (Battery Start) | 4-19 |
| ENGINE STARTING (With External Power) | 4-20 |
| ENGINE CLEARING PROCEDURES | 4-22 |
| ENGINE IGNITION PROCEDURES | 4-22 |
| BEFORE TAXIING | 4-23 |
| TAXIING | 4-24 |
| BEFORE TAKEOFF | 4-25 |

TABLE OF CONTENTS (CONTINUED)

| | Page |
|--|------|
| TAKEOFF | 4-27 |
| CLIMB | 4-28 |
| CRUISE | 4-30 |
| DESCENT | 4-31 |
| BEFORE LANDING | 4-32 |
| BALKED LANDING | 4-34 |
| AFTER LANDING | 4-35 |
| SHUTDOWN | 4-35 |
| POSTFLIGHT EMERGENCY LOCATOR TRANSMITTER | |
| CHECK | 4-36 |
| ENVIRONMENTAL SYSTEMS | 4-36 |
| Oxygen System | 4-36 |
| Heating and Ventilating Systems | 4-37 |
| OTHER NORMAL PROCEDURES | 4-37 |
| Fire Detection and Extinguishing System | 4-37 |
| Stall | 4-37 |
| Maneuvering Flight | 4-38 |
| Night Flying | 4-38 |
| Cold Weather Operation | 4-38 |
| AVIONICS SYSTEMS NORMAL PROCEDURES | 4-40 |
| NOISE ABATEMENT | 4-48 |
| PROCEDURES FOR PRACTICE DEMONSTRATION OF V_{MCA} | 4-49 |
| Practice Demonstration of V_{MCA} | 4-49 |
| Simulated Engine Failure in Takeoff Configuration | 4-50 |
| FUEL CONSERVATION | 4-50 |

INTRODUCTION

Section 4 describes the recommended procedures for normal operations. The first part of this section provides normal procedural action required in checklist form. Amplification of the abbreviated checklist is presented in the second part of this section.

NOTE

Refer to Section 9 for amended operating limitations, operating procedures, performance data and other necessary information for airplanes equipped with specific options.

AIRSPEEDS FOR NORMAL OPERATIONS

Conditions:

1. Takeoff Weight - 9360 Pounds
2. Landing Weight - 9360 Pounds
3. Sea Level, Standard Day

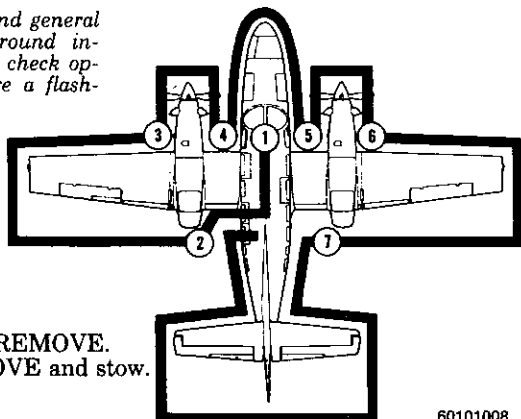
- | | |
|--|--------------------|
| (1) Air Minimum Control Speed With Wing Flaps In T.O. Position (V_{MCA}) | 90 KIAS |
| (2) Rotation Speed With Wing Flaps In T.O. Position (V_R) | 98 KIAS |
| (3) All Engines Best Angle-of-Climb With Wing Flaps In T.O. Position (V_X) | 102 KIAS |
| (4) All Engines Best Rate-of-Climb Speed With Wing Flaps In T.O. Position (V_Y) | 109 KIAS |
| (5) All Engines Best Rate-of-Climb Speed With Wing Flaps In UP Position (V_Z) | 112 KIAS |
| (6) Maximum Operating Speed (V_{MO}/M_{MO}) | 229 KIAS/0.52 Mach |
| (7) Maneuvering Speed (V_A) | 162 KIAS |
| (8) All Engines Landing Approach Speed With Wing Flaps In LAND Position | 101 KIAS |
| (9) Speed For Transition To Balked Landing Conditions | 101 KIAS |
| (10) Maximum Demonstrated Crosswind Velocity | 20 KNOTS |
| (11) Takeoff Decision Speed With Landing Gear Down (V_1) | 98 KIAS |
| (12) Takeoff Safety Speed (V_2) | 102 KIAS |
| (13) Intentional One Engine Inoperative Speed (V_{SSE}) | 98 KIAS |

NOTE

● Visually check inspection plates and general airplane condition during walk-around inspection. If night flight is planned, check operation of all lights and make sure a flashlight is available.

● Ensure airplane has been serviced with the proper grade and type of fuel.

● Refer to Section 8 for quantities, materials and specifications of frequently used service items.



60101008

- 1
 - a. Pitot Tube Cover(s) - REMOVE.
 - b. Control Locks - REMOVE and stow.
 - c. Parking Brake - SET.
 - d. All Switches - OFF.
 - e. All Circuit Breakers - IN.
 - f. Spare Fuses - ENSURE availability.
 - * g. Oxygen - ON; Quantity, Masks and Hoses (blue connector) - CHECK; Oxygen - OFF.
 - h. Landing Gear Switch - DOWN.
 - i. Trim Tab Controls (3) - SET for takeoff.
 - j. Fuel Crossfeed Selector - OFF.
 - k. Flap Position Lever and Indicator - CHECK in same position.
 - l. Battery Switch - ON.
 - m. Fuel Gages - CHECK quantity and operation.
 - * n. Fuel Totalizer - SET.
 - o. Anti-Collision Lights - CHECK operation then OFF.
 - p. Navigation Lights (3) - CHECK operation then OFF.
 - q. Landing Lights (2) - CHECK operation then OFF.
 - r. Taxi Light - CHECK operation then OFF.
 - * s. Surface Deice Lights (2) - CHECK operation then OFF.
 - * t. Wing Recognition Lights (2) - CHECK operation then OFF.
 - * u. Oscillating Beacon Ground Recognition Lights (2) - CHECK operation then OFF.
 - * v. Electric Windshield - CHECK operation by observing discharge on battery ammeter if inflight use is anticipated. Ensure system is turned off after operational check.
 - w. Pitot, Stall and Vent Heat Switch(es) - ON 20 seconds then OFF.
 - x. Battery Switch - OFF.
 - y. Cabin Fire Extinguisher - CHECK security and pressure.
 - z. Windshields and Windows - CHECK for cracks and general condition.

- 2
 - a. Wing Locker Baggage Door - SECURE and LOCKED.
 - b. Wing Flap - CHECK security and attachment.
 - c. Control Surface Lock - REMOVE, if installed.
 - d. Aileron and Tab - CHECK condition, freedom of movement and tab position.

* Denotes items to be checked if the applicable optional equipment is installed on your airplane.

**Figure 4-1 (Sheet 1 of 3)
PREFLIGHT INSPECTION**

- e. Trailing Edge Static Discharge Wicks - CHECK condition and attachment.
 - f. Stall Warning Vane - CHECK freedom of movement and warm.
 - g. Fuel Tank Fuel Quantity - CHECK; Cap - SECURE.
 - h. Fuel Tank Vent and Overboard Drain Line - CLEAR.
 - i. Bottom Outboard Wing - CHECK for fuel leaks or stains.
 - * j. Outboard Deice Boot - CHECK condition and security.
- 3
- a. Wing Tie Down - REMOVE.
 - b. Fuel Tank Sumps (2) - DRAIN; CHECK for water and contamination.
 - c. Engine Compartment General Condition - CHECK for fuel, oil, hydraulic fluid and exhaust leaks or stains.
 - d. Exhaust Stubs - EXAMINE stubs and scuppers for cracks or missing material.
 - e. Oil Cooler Inlet - CLEAR.
 - f. Oil Level - CHECK; Cap-Secure.
 - g. Propeller and Spinner - EXAMINE for nicks, security and oil leaks.
 - h. Intake Air Opening - CLEAR.
 - * i. Inboard Deice Boot - CHECK condition and security.
 - j. Main Gear, Strut, Door, Tire and Wheelwell - CHECK
 - k. Engine Fire Extinguisher Bottle Pressure - CHECK temperature/charge pressure on gage.
 - l. Crossfeed Line and Fuel Filter Drain - DRAIN; CHECK for water and contamination.
 - m. Hydraulic Fluid Relief Overboard Line - CLEAR.
 - n. Lower Fuselage, Nose and Center Section - CHECK for fuel, oil and hydraulic leaks or stains and antenna security.
 - o. Wing Leading Edge Vent Inlet and Outlet - CHECK clear of obstructions.
- 4
- a. Crew Door - UNLOCK door handle with key.
 - b. Hydraulic Fluid Reservoir Level - CHECK.
 - c. Emergency Landing Gear Blow Down Bottle Pressure - CHECK in the green arc. Check that red ring is not showing on the control rod. If red ring is visible, refer to the Airplane Maintenance Manual before flight.
 - d. Nose Baggage Door - SECURE and LOCKED (with key).
 - e. Avionics Bay Door - SECURE and LOCKED (with key).
 - f. Nose Gear, Strut, Stop Block, Door, Tire, Wheel Well - CHECK.
 - g. Tie Down - REMOVE.
 - h. Pitot Tube - CLEAR and WARM.
 - i. Ram Air Inlet - CLEAR.
 - j. Pitot Tube - CLEAR and WARM.
 - * k. Oxygen Overboard Discharge Indicator - CHECK green disc installed.
 - * l. Alcohol Reservoir - CHECK for quantity, dipstick in and cap closed.
 - m. Battery - CHECK.
 - n. Baggage Door - SECURE and LOCKED (with key).
- 5
- a. Wing Leading Edge Vent Inlet and Outlet - CHECK clear of obstructions.
 - b. Overboard Drain Lines (2) - CLEAR.
- * Denotes items to be checked if the applicable optional equipment is installed on your airplane.

Figure 4-1 (Sheet 2 of 3)
PREFLIGHT INSPECTION

- c. Lower Fuselage, Nose and Center Section - CHECK for fuel oil, and hydraulic fluid leaks or stains and antenna security.
 - d. Crossfeed Line and Fuel Filter Drain - DRAIN; CHECK for water and contamination.
 - e. Fuel Tank Sump (2) - DRAIN; CHECK for water and contamination.
 - f. Main Gear, Strut, Door, Tire and Wheel Well - CHECK.
 - g. Engine Fire Extinguisher Bottle Pressure - CHECK temperature/charge pressure on gage.
 - h. Oil Cooler Inlet - CLEAR.
 - i. Oil Level - CHECK; Cap-Secure.
 - j. Exhaust Stubs - EXAMINE stubs and scuppers for cracks or missing material.
 - * k. Inboard Deice Boot - CHECK condition and security.
 - l. Intake Air Opening - CLEAR.
 - m. Propeller and Spinner - EXAMINE for nicks, security and oil leaks.
 - n. Engine Compartment General Condition - CHECK for fuel, oil, hydraulic fluid and exhaust leaks.
 - o. Wing Tie Down - REMOVE.
- 6
- * a. Outboard Deice Boot - CHECK condition and security.
 - b. Bottom Outboard Wing - CHECK for fuel leaks or stains.
 - c. Fuel Tank Vent and Overboard Drain Line - CLEAR.
 - d. Fuel Tank Fuel Quantity - CHECK; Cap - SECURE.
 - e. Bottom Outboard Wing - CHECK for fuel leaks or stains.
 - f. Control Surface Lock - REMOVE, if installed.
 - g. Aileron - CHECK condition and freedom of movement.
 - h. Trailing Edge Static Discharge Wicks - CHECK condition and attachment.
 - i. Wing Flap - CHECK security and attachment.
 - j. Wing Locker Baggage Door - SECURE and LOCKED.
- 7
- a. Static Ports - CLEAR. Do not blow into static ports.
 - b. Tailcone Drain Holes - CHECK clear of obstructions.
 - * c. Horizontal Stabilizer Deice Boot - CHECK condition and security.
 - d. Control Surface Lock(s) - REMOVE, if installed.
 - e. Trailing Edge Static Discharge Wicks - CHECK condition and attachment.
 - f. Elevator and Tab - CHECK condition, freedom of movement and tab position.
 - g. Rudder Gustlock - RELEASED.
 - h. Rudder and Tab - CHECK condition, freedom of movement and tab position.
 - * i. Vertical Stabilizer Deice Boot - CHECK condition and security.
 - j. Tie Down - REMOVE.
 - k. Elevator and Tab - CHECK condition, freedom of movement. security.
 - * l. Horizontal Stabilizer Deice Boot - CHECK condition and security.
 - m. Static Ports - CLEAR. Do not blow into static ports.
 - * n. Cargo Door and Hinges - CHECK condition and security.
 - * o. Upper and Lower Cargo Door Latches - ENGAGED.
 - p. Cabin Door - CHECK security and condition.
- * Denotes items to be checked if the applicable optional equipment is installed on your airplane.

Figure 4-1 (Sheet 3 of 3)
PREFLIGHT INSPECTION

**NORMAL PROCEDURES
ABBREVIATED CHECKLIST****NOTE**

This Abbreviated Normal Procedures Checklist is included as a supplement to the Amplified Normal Procedures. Use of the Abbreviated Normal Procedures Checklist should not be used until the flight crew has become familiar with the airplane and systems. All amplified normal procedure items must be accomplished regardless of which checklist is used.

BEFORE ENGINE STARTING

1. Preflight - COMPLETE.
2. Crew Door - LATCHED and SECURE.
3. Cabin Door(s) - LATCHED and SECURE.
4. Baggage - SECURE.
5. Parking Brake - SET.
6. Control Locks - REMOVE.
7. Seat, Seat Belts and Shoulder Harness - ADJUST and SECURE.
8. Fuel Crossfeed Selector - OFF.
9. Cabin Heat Source Selector - OFF.
10. Cowl Flaps - OPEN.
11. All Switches and Circuit Breakers - OFF and Set.
12. Generator Switches - CHECK OFF.
13. Battery Switch - ON.
14. Interior and Exterior Lights - AS REQUIRED.
15. Passenger Advisory Lights - ON.
16. Landing Gear Switch - DOWN; Check Green Lights - ON.
17. Annunciator Panel, Warning Lights and Warning Horns - PRESS-TO-TEST.
18. Firewall Shutoff Switches - CYCLE, lights check.
19. Fuel Quantity - CHECK.
20. Fuel Totalizer - SET (if installed).
21. Air Conditioner - OFF.
22. Power Levers - FLIGHT IDLE.
23. Propeller Control Levers - FEATHER.
24. Fuel Control Levers - CUTOFF.

ENGINE STARTING (Battery Start)

1. Voltmeter - CHECK (24 volts minimum).
2. Propellers - CLEAR.
3. Fuel Auxiliary Boost Pump - ON. Check Auxiliary boost pump annunciator light-ON, fuel pressure low light-OFF.
4. Start Switch - START.
5. Ignition Light - CHECK ON.
6. Fuel Control Lever - RUN Above 12 percent N_g .
7. ITT and N_g - MONITOR (1090 degrees Celsius Maximum).
8. Start Light - OFF Above 42 percent N_g .
9. Start Switch - OFF (N_g 52 percent or Above).
10. Engine Instruments - CHECK.
11. Power Lever - INCREASE to 68 percent N_g .
12. Generator Switch - ON.
13. After generator output decreases below 200 Amperes repeat steps 2 through 10, and 12 on opposite engine.
14. Power Levers - FLIGHT IDLE.

ENGINE STARTING (With External Power)

1. Battery and Generator Switches - OFF.
2. External Power Unit - ENGAGE; then ON.
3. Propellers - CLEAR.
4. Fuel Auxiliary Boost Pump - ON. Check AUX PUMP ON annunciator light on, FUEL PRESS LOW annunciator light - OFF.
5. Start Switch - START.
6. Ignition Light - CHECK ON.
7. Fuel Control Lever - RUN Above 12 percent N_g .
8. ITT and N_g - MONITOR (1090 degrees Celsius Maximum).
9. Start Light - OFF Above 42 percent N_g .
10. Start Switch - OFF (N_g 52 percent or Above).
11. Engine Instruments - CHECK.
12. Second Engine - START - Repeat steps 3 through 11.
13. Battery Switch - ON.
14. External Power Unit - DISENGAGE and REMOVE.
15. Generator Switches - ON.

BEFORE TAXIING

1. Passenger Briefing - COMPLETE.
2. Fuel Auxiliary Boost Pump - OFF MOMENTARILY, check annunciators - OFF.
3. Fuel Auxiliary Boost Pump - NORMAL, check annunciator lights - OFF.
4. Instrument Air Pressure - CHECK.
5. Fuel Control Heaters - ON.
6. Avionics Bus Switches - ON.
7. Inverter Switch - ON.
8. Avionics - AS REQUIRED.
9. Cabin Temperature Controls - AS REQUIRED.
10. Lights - AS REQUIRED.
11. Propeller Control Levers - FORWARD.
12. Brakes - RELEASE.

TAXIING

1. Brakes - CHECK.
2. Flight Instruments - CHECK.

BEFORE TAKEOFF

1. Parking Brakes - SET.
2. Engine Instruments - CHECK.
3. Outside Air Temperature Gage - CHECK.
4. Fuel Quantity and Balance - CHECK.
5. Fuel Crossfeed - CYCLE, then OFF.
6. Trim Tabs - SET.
7. Second Stall Warning - CHECK.
8. Wing Flaps - VERIFY T.O. Position.
9. Propeller Synchrophaser - OFF.
10. Autopilot/Yaw Damper - OFF (if installed).
11. Flight Controls - CHECK.
12. Avionics, Flight Instruments and Radar - CHECK and SET.
13. Overspeed Governors - CHECK.
14. Autofeather - CHECK.
15. Autofeather - ARM.
16. Lights - AS REQUIRED.
17. Annunciator Panel - CLEAR.

18. Ice Protection - AS REQUIRED.
19. Anti-collision Lights - ON.
20. Recognition Lights - ON (if installed).
21. Pitot/Static Heat - ON.
22. Seat Belts and Shoulder Harness - SECURE.
23. Parking Brakes - RELEASE.

TAKEOFF

1. Power - SET FOR TAKEOFF.
2. Annunciators - CHECK, autofeather lights illuminated.
3. Engine Instruments - CHECK.
4. Rotate - V_R (98 KIAS).
5. Airspeed - 102 KIAS until obstacles are cleared.
6. Brakes - APPLY momentarily.
7. Landing Gear - RETRACT.
8. Airspeed - 112 KIAS.
9. Wing Flaps - UP.

CLIMB

1. Power - SET (Observe ITT, torque and N_g RPM limits).
2. Propellers - Synchronize manually.
3. Propeller Synchrophaser - PHASE as desired.
4. Airspeed - 140 KIAS (112 KIAS for maximum climb).
5. Cowl Flaps - AS REQUIRED.

CRUISE

1. Power - Set-Torque/RPM as desired (Observe ITT, torque and N_g RPM limits).
2. Propeller Synchrophaser - PHASE as desired.
3. Cowl Flaps - AS REQUIRED.
4. Fuel Crossfeed Selector - AS REQUIRED.
5. Autofeather - OFF.

DESCENT

1. Cabin Heat Source Selector and Cabin Heat Controls - AS REQUIRED.
2. Defroster Knob - PULL.
3. Fuel Crossfeed Selector - OFF.
4. Autofeather - ARM.
5. Ice Protection - AS REQUIRED.
7. Cowl Flaps - AS REQUIRED (Open if descending into warm air).
8. Altimeter - SET.
9. Passenger Advisory Lights - AS REQUIRED.
10. Seat Belts and Shoulder Harness - SECURE.

BEFORE LANDING

1. Wing Flaps - T.O. or APPR below 200 KIAS.
2. Fuel Quantity and Balance - CHECK.
3. Fuel Crossfeed Selector - OFF.
4. Landing Gear - DOWN below 180 KIAS.
5. Wing Flaps - LAND.
6. Landing and Taxi Lights - AS REQUIRED.
7. Propeller Synchrophaser - OFF.
8. Propeller Control Levers - FORWARD.
9. Autopilot/Yaw Damper - OFF (if installed).
10. Approach Speed - 101 KIAS.
11. Power Levers - FLIGHT IDLE at touchdown.
12. Power Levers - GROUND IDLE after touchdown.
13. Brakes and Reverse - AS REQUIRED.

BALKED LANDING

1. Power Levers - ADVANCE for takeoff power.
2. Balked Landing Transition Speed - 101 KIAS.
3. Wing Flaps - T.O..
4. Landing Gear - RETRACT during IFR go-around or simulated IFR go-around after establishing a positive rate-of-climb.
5. Trim airplane for climb.
6. Airspeed - ACCELERATE to 112 KIAS (after clearing obstacles).
7. Wing Flaps - UP as soon as all obstacles are cleared and a safe altitude and airspeed are obtained.

AFTER LANDING

1. Ice Protection Equipment - OFF.
2. Pitot/Static Heat - OFF.
3. Transponder - SBY.
4. Radar - STBY (if installed).
5. Anti-collision Lights - OFF.
6. Recognition Lights - OFF (if installed).
7. Wing Flaps - T.O.
8. Lights - AS REQUIRED.
9. Cowl Flaps - OPEN.

SHUTDOWN

1. Parking Brake - SET if brakes are cool.
2. Postflight ELT Check - COMPLETE.
3. Avionics Master Switches - OFF.
4. Inverter Switch - OFF.
5. Fuel Control Heater Switches - OFF.
6. Accessory Switches - OFF.
7. Power Levers - FLIGHT IDLE.
8. Propeller Control Levers - FEATHER.
9. ITT below 610 degrees Celsius for one minute.
10. Fuel Control Levers - CUT OFF.
11. Fuel Auxiliary Boost Pumps - OFF.
12. Generator Switches - OFF.
13. Battery Switch - OFF.

POSTFLIGHT EMERGENCY LOCATOR TRANSMITTER CHECK

1. VHF Communications Transceiver - ON and select 121.5 MHz.
2. Audio Control Panel - AS REQUIRED.
3. If Audible Tone Heard - Emergency locator transmitter switch OFF then NORM.

ENVIRONMENTAL SYSTEMS**OXYGEN SYSTEM (IF INSTALLED)**

If oxygen use is desired, proceed as follows:

1. Oxygen Control Knob - PULL ON.
2. Mask - Connect and put mask on.
3. Oxygen Flow Indicator - CHECK flow (green indicates flow).

HEATING AND VENTILATING SYSTEMS

Heater Operation - Ground:

1. Starting Engine Procedures - COMPLETED.
2. Cabin Heat Source Select - BOTH.
3. Cabin Heat Auto Control - MANUAL.
4. Cabin Heat Manual Switch - AS DESIRED.
5. Defrost and Cockpit/Cabin Air Knobs - AS DESIRED.
6. Cabin Heat Auto Control - ROTATE AS DESIRED.

Heater Operation - Flight:

1. Cabin Heat Source Select - BOTH.
2. Cabin Heat Auto Control - AS DESIRED.
3. Defrost and Cockpit/Cabin Air Knobs - AS DESIRED.

1

2

AMPLIFIED NORMAL PROCEDURES

PREFLIGHT INSPECTION

The Preflight Inspection, described in Figure 4-1, is recommended for the first flight of the day. Inspection procedures for subsequent flights may be abbreviated at the pilot's discretion.

NOTE

If a subsequent preflight inspection is performed shortly after shutdown, be aware that engine air intake leading edge as well as exhaust outlets may be very hot.

If the airplane has been in extended storage, has had recent major maintenance or has been operated from marginal airports, a more extensive exterior inspection is recommended.

After major maintenance has been performed, a thorough preflight inspection, accordance with Figure 4-1, should be completed. Pay particular attention to the security of access panels and doors and free and correct movement of control surfaces. If the airplane has been waxed or polished, check the external static pressure source holes for obstructions.

The fire extinguisher bottles, located in main wheel well, should be checked for the properly serviced indication. The indicated pressure will change with change in ambient temperature.

If the airplane has been exposed to much ground handling, or has been parked in a crowded hangar, it should be checked for dents and scratches on wings, fuselage and tail surfaces, as well as damage to navigation, anti-collision and landing lights, deice boots and avionics antennas.

Outside storage may result in water and obstructions in airspeed system lines, condensation in fuel tanks, and dust and dirt in the engine air inlet and exhaust areas. If any water is detected in the fuel system, the fuel tank sump quick-drain valves, fuel crossfeed line quick-drain valves and fuel filter quick-drain valves should all be thoroughly drained until there is no evidence of water or sediment contamination. Outside storage in windy or gusty areas, or adjacent to taxiing airplanes, calls for special attention to control surface stops, hinges and brackets to detect presence of wind damage. The recommended use of the control locks will remove this problem.

Prolonged storage of the airplane will result in a water buildup in the fuel which "leaches out" the fuel additive. An indication of this is when an excessive amount of water accumulates in the fuel tank sumps. Refer to Section 8 for fuel additive servicing.

Exhaust stubs and the exhaust heated inlet scuppers inside each stub should be inspected for overall condition prior to each flight. Missing or cracked scuppers may prevent the continuous inlet heat from operating properly.

If the airplane has been operated from muddy fields or in snow or slush, check the main gear and nose gear wheel wells for obstructions and cleanliness. Operation from a gravel or cinder field will require extra attention to propeller tips and horizontal stabilizer leading edges where abrasion can be encountered. Propeller stone damage can seriously reduce the fatigue life of the blades.

Frequently check all components of the landing gear retracting mechanisms, shock struts, tires and brakes. This is especially important on airplanes operating from rough fields and/or high altitudes. Improperly serviced shock struts could cause excessive landing and taxi loads on the airplane structure. Landing gear shock struts should be checked before each flight to ensure they are not collapsed. This can readily be determined by a visual inspection of the shock strut lower piston assembly. If the unpainted surface of the lower piston assembly is not visible, the shock strut is collapsed and must be serviced before the airplane is operated. A completely collapsed (zero extension) shock strut could cause a malfunction in the landing gear retraction system. Airplanes that are operated from rough fields, especially at high altitudes, are subjected to abnormal landing gear abuse.

To prevent loss of fuel in flight, make sure the fuel tank filler caps are tightly sealed. The fuel tank vents on the lower surface of the tanks should also be inspected for obstructions, ice or water, especially after operation in cold, wet weather.

The interior inspection will vary according to the planned flight and the optional equipment installed. Prior to high-altitude flights, it is important to check the condition and quantity of oxygen face masks (if installed) and hose assemblies. The oxygen supply system (if installed) should be functionally checked to ensure that it is in working order. The oxygen pressure gage (if installed) should indicate 300 to 1850 pounds per square inch depending upon the anticipated requirements.

Satisfactory operation of the fuel control heaters, pitot tubes, static sources and stall warning transmitter heating elements is determined by observing a discharge on the ammeter when the fuel control, pitot/static and stall vane switches are turned ON. Actuating the pitot/static and stall vane switches for 20 seconds, immediately prior to the exterior inspection, will warm the heating elements sufficiently so they will feel warm to the touch during the inspection. If operation of the static source heaters is questionable, run the back of a finger from the fuselage skin across the static port and then onto the fuselage skin. If operation is still questionable, the effectiveness of these heating elements can be verified by cautiously feeling the heat of these devices while the pitot/static heat switches are on.

If the emergency landing gear extension T-handle was noticed to be partly extended during the cockpit preflight inspection, the emergency landing gear extension blow down valve assembly should be reset at the blowdown bottle in the left nose compartment in accordance with the airplane Maintenance Manual. If the red band is visible, the blowdown bottle must be serviced in accordance with the airplane Maintenance Manual before flight. If the red band is not showing, push the cable towards the valve assembly, then check the bottle pressure gage for normal pressure.

Flights at night and in cold weather involve a careful check of other specific areas which will be discussed later in this section.

BEFORE ENGINE STARTING

1. Preflight - COMPLETE.
2. Crew Door - LATCHED and SECURE.
3. Cabin Door(s) - LATCHED and SECURE.
4. Baggage - SECURE.
5. Parking Brake - SET.
6. Control Locks - REMOVE.
7. Seat, Seat Belts and Shoulder Harness - ADJUST and SECURE.
8. Fuel Crossfeed Selector - OFF.
9. Cabin Heat Source Selector - OFF.
10. Cowl Flaps - OPEN.
11. All Switches and Circuit Breakers - OFF and SET.
12. Generator Switches - CHECK OFF.
13. Battery Switch - ON.
14. Interior and Exterior Lights - AS REQUIRED.
 - a. Master Lighting Switch - AS REQUIRED.
 - b. Panel Lights - AS REQUIRED.
 - c. External Lights - CHECK OFF.

NOTE

Ground operation of the high intensity anti-collision lights can be of considerable annoyance to ground personnel and other pilots.

15. Passenger Advisory Lights - ON.
16. Landing Gear Switch - DOWN; Check Green Lights - ON.

17. Annunciator Panel and Warning Lights - PRESS-TO-TEST.

- a. Annunciator Panel Master
Warning Lights - PRESS to reset master warning.

NOTE

The press-to-test function will also test the landing gear warning horn, stall warning horn, autopilot mode repeater annunciators, all marker beacon lights, altitude alert annunciator and the RN and BC lights in the NAV 2 Indicator. The gyro inverter and avionics bus switches must be ON to check the light displays in the autopilot mode selector.

18. Firewall Shutoff Switches - DEPRESS, Bleed Off or Optional Fire Bottle Armed lights illuminated; DEPRESS again, lights go out.



ANY TIME THE WHITE FIRE EXTINGUISHER LIGHTS ARE ILLUMINATED, DEPRESSING THE BUTTON WILL FIRE THE BOTTLE.

19. Fuel Quantity - CHECK.
20. Fuel Totalizer - SET (if installed).
21. Air Conditioner - OFF.
22. Power Levers - FLIGHT IDLE.



THE PROPELLER REVERSING LINKAGE CAN BE DAMAGED IF THE POWER LEVERS ARE MOVED AFT OF THE FLIGHT IDLE DETENT WHEN THE ENGINES ARE NOT RUNNING.

23. Propeller Control Levers - FEATHER.
24. Fuel Control Levers - CUTOFF.

ENGINE STARTING (Battery Start)

1. Voltmeter - CHECK (24 volts minimum).
2. Propellers - CLEAR.
3. Fuel Auxiliary Boost Pump - ON. Check AUX PUMP ON annunciator light ON, FUEL PRESS LOW annunciator OFF.
4. Start Switch - START.
5. Ignition Light - CHECK ON.
6. Fuel Control Lever - RUN above 12 percent N_g .
7. ITT and N_g - MONITOR (1090 degrees Celsius maximum).

CAUTION

IF NO ITT RISE IS OBSERVED WITHIN 10 SECONDS AFTER MOVING THE FUEL CONTROL LEVER TO RUN, OR ITT RAPIDLY APPROACHES 1090 DEGREES CELSIUS, MOVE THE FUEL CONTROL LEVER TO CUT-OFF AND PERFORM ENGINE CLEARING PROCEDURE.

8. Start Light - OFF above 42 percent N_g .
9. Start Switch - OFF (N_g 52 percent or Above).
10. Engine Instruments - CHECK.
11. Power Lever - Increase to 68 percent N_g .
12. Generator Switch - ON.
13. After generator output decreases below 200 amperes, repeat steps 2 through 10, and 12 on opposite engine.

NOTE

●During a cross start of either engine the ENG START light for the first engine started may blink as the engine being started nears the end of its start cycle. Normally the light will not blink but if it does it is acceptable.

●If either ENG START light remains ON after engine start, the start relay or cross start relay is closed. Perform SHUTDOWN.

14. Power Levers - FLIGHT IDLE.

NOTE

Do not operate air conditioner during engine starts.

ENGINE STARTING (With External Power)

1. Battery and Generator Switches - OFF.

CAUTION

SHOULD THE EXTERNAL POWER UNIT DROP OFF LINE DURING START, A TOTAL LOSS OF ELECTRICAL POWER WILL RESULT WHICH COULD RESULT IN A HOT START (ITT WILL BE INOPERATIVE). SHOULD A LOSS OF ELECTRICAL POWER OCCUR, IMMEDIATELY PLACE THE FUEL CONTROL LEVER TO CUT OFF, TURN THE BATTERY SWITCH ON, MONITOR ITT AND ENSURE THE ENGINE IS SHUTTING DOWN. PLACE THE STARTER SWITCH TO THE MOTOR ONLY POSITION TO AID IN REDUCING ITT IF NECESSARY.

NOTE

When an external power unit is used, ensure the unit is negatively grounded and regulated to 28 volts DC with a capability of providing a minimum of 800 amperes during the starting cycle. External power units with output exceeding 1700 amperes shall not be used.

2. External Power Unit - ENGAGE; then ON.
3. Propellers - CLEAR.
4. Fuel Auxiliary
Boost Pump - ON. Check AUX PUMP ON annunciator light ON,
FUEL PRESS LOW annunciator light - OFF.
5. Start Switch - START.
6. Ignition Light - CHECK ON.
7. Fuel Control Lever - RUN above 12 percent N_g . maximum).

CAUTION

IF NO ITT RISE IS OBSERVED WITHIN 10 SECONDS AFTER MOVING THE FUEL CONTROL LEVER TO RUN, OR ITT RAPIDLY APPROACHES 1090 DEGREES CELSIUS, MOVE THE FUEL CONTROL LEVER TO CUT-OFF, START SWITCH OFF AND PERFORM ENGINE CLEARING PROCEDURES.

8. ITT and N_g - MONITOR (1090 degrees Celsius maximum).
9. Start Light - OFF above 42 percent N_g .
10. Start Switch - OFF (N_g 52 percent or above).
11. Engine Instruments - CHECK.
12. Second Engine - START - Repeat steps 3 through 11.

NOTE

● *During a cross start of either engine the ENG START light for the first engine started may blink as the engine being started nears the end of its start cycle. Normally the light will not blink but if it does it is acceptable.*

● *If either ENG START light remains ON steady after engine start, the start relay or cross start relay is closed. Perform SHUTDOWN.*

13. Battery Switch - ON.
14. External Power Unit - DISENGAGE and REMOVE.
15. Generator Switches - ON.

Engine starts may be made with airplane battery power or with an external power unit. However, it is recommended that an external power unit be used when the ambient air temperature is less than 0 degrees Fahrenheit (-18 degrees Celsius). Refer to Cold Weather Operation in this section when ambient temperature is below 0 degrees Fahrenheit (-18 degrees Celsius).

Before engine starting with the airplane batteries, check the voltmeter for a minimum of 24 volts. After starting the first engine, allow the generator charge rate to decrease below 200 amperes before starting the second engine.

With turbine engines, the operator must monitor ITT during each engine start to guard against a "hot" start. The operator must be ready to immediately stop the start if ITT exceeds 1090 degrees Celsius or is rapidly approaching this limit. Usually "hot" starts are not a problem if the normal starting procedures are followed. A "hot" start is caused by excessive fuel flow at normal revolutions per minute or normal fuel flow with insufficient revolutions per minute. The latter is usually the problem which is caused by attempting a start with low battery voltage. If a cold engine does not quite idle at 52 percent, it is acceptable to advance the power lever slightly. If the starter accelerates the gas generator rapidly above 20 percent, suspect gear train decouple. Do not continue start. Rapid acceleration through 35 percent N_g suggests a start on the secondary nozzles. Anticipate a hot start.

After an aborted start for whatever reason, it is essential before the next start attempt to allow adequate time to drain off unburnt fuel. Failure to drain all residual fuel from the engine could lead to a hot start, a hot streak leading to hot section damage, or the torching of burning fuel from engine exhaust on the next successful ignition.

A dry motoring, within starter limitation after confirming that all fuel drainage has stopped, will ensure that no fuel is trapped before the next start.

ENGINE CLEARING PROCEDURES

1. Fuel Control Lever - CUTOFF.
2. Fuel Auxiliary Boost Pump - ON.
3. Start Switch - MOTOR.



*DO NOT EXCEED THE STARTING CYCLE
LIMITATIONS; REFER TO SECTION 2.*

4. Start Switch - OFF.
5. Fuel Auxiliary Boost Pump - OFF.

ENGINE IGNITION PROCEDURES

For most operations, the ignition switch is left in the NORM position. With the switch in this position, ignition is ON only when the starter switch is in the START position.

However, the ignition switch should be turned ON to provide continuous ignition under the following conditions:

1. Emergency engine starts without starter assist.
2. Operation on water or slush covered runways.
3. Flight in heavy precipitation.
4. During inadvertent icing encounters until the inertial has been in BYPASS for 5 minutes.
5. When near fuel exhaustion as indicated by RESERVOIR FUEL LOW annunciator ON.

BEFORE TAXIING

1. Passenger Briefing - COMPLETE.
2. Fuel Auxiliary Boost Pump - OFF momentarily, check AUX PUMP ON and FUEL PRESS LOW annunciators - OFF.
3. Fuel Auxiliary Boost Pumps - NORMAL, check annunciator lights - OFF.
4. Instrument Air Pressure - CHECK.
5. Fuel Control Heaters - ON.
6. Avionics Bus Switches - ON.
7. Inverter Switch - ON.
8. Avionics - SET.
9. Cabin Temperature Controls - AS REQUIRED.
 - a. If heating/defrosting are desired:
 - (1) Cabin Heat Source Select - BOTH.

NOTE

Manual Cabin Heat Control will open and close the temperature control valve faster than Auto Cabin Heat Control.

- (2) Cabin Heat Auto Control - ROTATE AS DESIRED.
- (3) Defrost and Cockpit/Cabin Air Knobs - AS DESIRED.
- b. If ventilation is required:
 - (1) Cabin Heat Source Select - OFF.
 - (2) Fresh Air Fan Switch - LOW or HIGH.
 - (3) Ram Air Knob - PUSH.
 - (4) Defrost and Cabin/Cockpit Air Knobs - AS DESIRED.
 - (5) Overhead Ventilation Blower Switch (If Installed) - HIGH or LOW.
10. Lights - AS REQUIRED.
11. Propeller Control Levers - FORWARD.

NOTE

Do not use reverse unless the propeller control levers are in the full forward position.

12. Brakes - RELEASE.

TAXIING

1. Brakes - CHECK.
2. Flight Instruments - CHECK.

A steerable nosewheel, interconnected with the rudder system, provides positive control up to 15 degrees left or right, and free turning from 15 degrees to 50 degrees for sharp turns during taxiing. Normal steering may be aided through use of differential braking and differential power on the main wheels. These aids are listed in the preferred order of use. Do not use excessive brake on the inboard side to effect a turning radius as decreased tire life will result.

NOTE

If the airplane is parked with the nosewheel castered in either direction, initial taxiing should be done with caution. To straighten the nosewheel, use full opposite rudder and differential power instead of differential braking. After a few feet of forward travel, the nosewheel will steer normally.

When taxiing near buildings or other stationary objects, observe the minimum turning distance limits; refer to Section 7. No abnormal precautions are required when taxiing in conditions of high winds.

At some time early in the taxi run, the brakes should be checked for any unusual reaction, such as uneven braking. The horizontal situation indicator should be checked for normal slaving and cross-checked with the standby magnetic compass. Normal slaving is indicated by oscillations of the gyro slaving indicator about the null point (45 degrees fixed reference line on the HSI).

Taxi speed can be reduced by using normal braking or by retarding the power levers toward reverse as desired. Minimize the use of reverse thrust on unprepared surfaces. Placing one propeller into feather can aid in reducing taxiing speed.

BEFORE TAKEOFF

1. Parking Brakes - SET.
2. Engine Instruments - CHECK.
3. Outside Air Temperature Gage - CHECK.
4. Fuel Quantity and Balance - CHECK. 200 pounds per side minimum. Do not exceed 300 pounds asymmetric fuel loading.
5. Fuel Crossfeed - CYCLE, then OFF.
6. Trim Tabs - SET elevator, aileron and rudder tabs in the TAKEOFF range.
7. Second Stall Warning - CHECK.
 - a. Elevator - FULL Nose up.
 - b. Wing Flaps - EXTEND to LAND position.
 - c. Stall Warning Horn - VERIFY operation.
 - d. Wing Flaps - RETRACT to T.O. position.
 - e. Stall Warning Horn - VERIFY Horn silences.
8. Wing Flaps - VERIFY T.O. position.
9. Propeller Synchrophaser - OFF.
10. Autopilot/Yaw Damper - OFF (if installed).
11. Flight Controls - CHECK.
12. Avionics, Flight Instruments and Radar - CHECK and SET.
13. Overspeed Governors - CHECK (first flight of the day and after maintenance).
 - a. Propeller Control Lever - FORWARD.
 - b. Governor Switch - TEST.
 - c. Power Levers - INCREASE RPM. Propeller should stabilize at 1725 ± 50 RPM.
 - d. Power Levers - DECREASE RPM.
 - e. Governor Switch - RELEASE (switch is spring-loaded to NORMAL).
14. Autofeather - CHECK (every flight).
 - a. Autofeather Switch - TEST.
 - b. Power Levers - INCREASE until torques are 400 foot-pounds. Assure that both AUTO FTHER ARM annunciator lights are illuminated. Slowly retard the LH power lever to FLIGHT IDLE noting that in sequence: The R AUTO FTHER ARM annunciator extinguishes, the L AUTO FTHER ARM annunciator extinguishes below 225 foot-pounds torque and the LH propeller begins to feather. Increase the left torque to 400 foot-pounds. Repeat procedure for right engine.

NOTE

● *Turbine inertia during feather may drive torque past the switch set point and cause the AUTO FETHER ARM annunciator to cycle off and on.*

● *Proper system operation is confirmed once the propeller begins to feather. It is not necessary to sustain the test conditions until the propeller is fully feathered.*

● *Cold engine oil may cause slow propeller feathering response. Assure that the propeller begins to feather within 4 seconds after the second annunciator extinguishes.*

c. Power Levers - FLIGHT IDLE.

15. Autofeather - ARM.
16. Lights - AS REQUIRED.
17. Annunciator Panel - CLEAR.
18. Ice Protection Equipment - CHECKED and AS REQUIRED if visible moisture is anticipated with outside air temperature below 4 degrees Celsius (40 degrees Fahrenheit).
 - a. Heated Windshield - CHECKED.
 - b. Stall Vane Heat - AS REQUIRED.
 - c. Propeller Deice - AS REQUIRED.
 - d. Engine Inertial Separator Switches - AS REQUIRED.
19. Anti-collision Lights - ON.
20. Recognition Lights - ON (if installed).
21. Pitot/Static Heat - ON.
22. Seat Belts and Shoulder Harness - SECURE.
23. Parking Brakes - RELEASE.

Ensure the Before Takeoff Checklist is followed to prevent missing an important item.

The flight and engine instruments should be checked for normal indications with no warning flags visible. All avionics should be set and checked for correct frequencies or operational modes. The altimeters should be set to reported field pressure, then crosschecked with each other and against field elevation.

A mental review of all engine inoperative speeds, procedures and field length requirements should be made before takeoff. Also, review the normal speeds and power limits (torque, ITT and fuel flow).

NOTE

Ensure weight does not exceed 9360 pounds before takeoff.

TAKEOFF

1. Power - SET FOR TAKEOFF (1382 foot-pounds torque maximum).
2. Annunciators - CHECK Autofeather Armed Lights - Illuminated.

WARNING

●DO NOT TAKE OFF WITH AUTO-FEATHER INOPERATIVE.

●AUTOFEATHER ARM ANNUNCIATOR LIGHTS SHOULD ILLUMINATE BETWEEN 80 AND 86% N_x AND REMAIN ILLUMINATED AT HIGHER N_x SETTINGS.

3. Engine Instruments - CHECK.
4. Rotate - V_R (98 KIAS).
5. Airspeed - 102 KIAS until obstacles are cleared.
6. Brakes - APPLY momentarily.
7. Landing Gear - RETRACT. Check GEAR UNLOCKED and HYD PRESS ON lights off.
8. Speed at 50 feet - 102 KIAS.
9. Best Rate-of-Climb Speed - 112 KIAS.
10. Wing Flaps - UP.

Before initiating the takeoff roll, a go, no-go decision should have been made in the event an engine failure should occur. Review the anticipated performance presented in Section 5 and assure that the operating weight limits of Section 2 are not exceeded. In addition, review the applicable procedures and speeds associated with one-engine operation so that the transition (in the event of an engine failure) will be smooth, positive and safe. If the anticipated performance exceeds the runway length available or obstacle clearance requirements cannot be achieved, it is recommended to take off on a more favorable runway, off-load the airplane until the anticipated performance is consistent with existing conditions or delay the takeoff until more favorable atmospheric conditions exist.

Full power operation is recommended on takeoff since it is important that V_1 is obtained as rapidly as possible. Accelerate the airplane to V_1 before rotation for additional safety in case of an engine failure.

Takeoff roll is most smoothly initiated by gradually advancing the power levers until the propeller revolutions per minute nears 1900. Hesitate slightly to allow the engine to approach stabilization, then smoothly release the brakes and continue advancing power levers to match torques until the takeoff limit (1382 foot-pounds) is reached. (Unless readjusted, torque will increase approximately 50 foot-pounds as speed builds up during takeoff roll.) If power levers are advanced too far too rapidly during initial application, expect a surge as the propeller governors begin demanding greater blade angle. For maximum performance takeoff power should be set before brake release. On runways where propeller damage from foreign objects is likely, allowing speed to build before applying full power may be beneficial. Allowing the propellers time to spool up before applying takeoff torque during a touch and go landing will minimize any asymmetric thrust.

For crosswind takeoffs the airplane is accelerated to a slightly higher than normal rotation speed, and then is pulled off abruptly to prevent possible settling back to the runway while drifting. When clear of the ground, a coordinated turn is made into the wind to correct for drift.

After rotation at 98 KIAS, allow the airspeed to increase to V_2 . Maintain 102 KIAS until the obstacles have been cleared.

On long runways, the landing gear should be retracted at the point over the runway where a wheels-down forced landing on that runway would become impractical. However, on short runways, it may be preferable to retract the landing gear after the airplane is safely airborne.

Before retracting the landing gear, apply the brakes momentarily to stop the rotation of the main wheels. Centrifugal force caused by the rapidly rotating wheels expands the diameter of the tires, and if ice or mud has accumulated in the wheel wells, the rotating wheels may rub as they enter.

To establish climb configuration, retract the landing gear, allow airspeed to increase to 112 KIAS, retract the wing flaps and then increase airspeed to 140 KIAS. Maintain takeoff power.

CLIMB

1. Power - SET - Torque/RPM as desired (Observe ITT, Torque and N_g RPM limits).
2. Propellers - SYNCHRONIZE manually.
3. Propeller Synchrophaser - PHASE as desired.

4. Recommended Climb Speed -

| CLIMB SPEED KIAS | PRESSURE ALTITUDE - FEET |
|---------------------|-----------------------------|
| 140 | SL to 12,000 |
| 125 | 12,000 to 20,000 |
| 110 | 20,000 to 30,000 |

5. Speed for Maximum Climb - 112 KIAS (if required).

6. Cowl Flaps - AS REQUIRED.

Normally, maximum climb power is maintained during the climb to cruise altitude. Adjust the power levers as required to prevent exceeding 1382 foot-pounds torque or a nominal climb ITT of 680 degrees Celsius, whichever occurs first.

NOTE

To prolong engine life, do not exceed 680 degrees Celsius ITT during climb.

This power setting provides the best performance and range. At lower altitudes and outside air temperatures (below approximately 15,000 feet), the engines will reach the torque limit before reaching the ITT or N_g limit. As the climb progresses, the ITT and N_g will increase until an altitude is reached where the ITT or N_g will dictate power lever positioning. When operating near the ITT limit, advance power levers slowly to allow current ITT to be indicated. The rate of power (and temperature) increase of the engine is greater than the response rate of the ITT therefore, a rapid power lever advance could allow an overtemperature condition to exist momentarily in the engine before the overtemperature would be indicated.

Prior to engaging the synchrophaser system, the propellers revolutions per minute must be closely synchronized manually (confirm with a check of the propeller tachometers) due to the limited capture range feature of the system.

After light illumination, confirm the propeller revolutions per minute has not exceeded 1900 revolutions per minute. The propeller revolutions per minute can be adjusted by symmetrically moving the propeller controls as required. The PHASE knob may then be rotated as required to achieve the desired noise characteristics.

If a major propeller revolutions per minute change is made with the synchrophaser system ON and the propeller controls are not moved symmetrically, the synchrophaser may break lock resulting in propeller speed oscillation. The system should be turned OFF, the propeller revolutions per minute reset manually and the synchrophaser turned back on.

For most normal flight operations, the cowl flaps may be allowed to trail. In very hot ambient conditions, it may be necessary to lock the cowl flaps fully open during climb.

CRUISE

1. Power - Set torque/RPM - As desired (observe ITT, torque and N_g RPM limits). For torque limit refer to Maximum Cruise Power Chart in Section 5.
2. Propeller Synchrophaser - PHASE as desired.
3. Cowl Flaps - AS REQUIRED.
4. Fuel Crossfeed Selector - AS REQUIRED.
5. Autofeather - OFF.

Do not exceed the maximum cruise torque shown in Section 5. Normally, new engines should exhibit an ITT slightly below 695 degrees Celsius when set to maximum cruise torque.

Before visible moisture is encountered with outside air temperature between -30 degrees Celsius (-22 degrees Fahrenheit) and 4 degrees Celsius (40 degrees Fahrenheit), ensure the anti-icing systems (windshield, pitot/static, stall vane, propeller heat and inertial separators) are ON and operating. These systems are designed to prevent ice formation, rather than removing it after it has formed. Accumulation of some airframe ice is unavoidable; this will increase airplane weight and drag and decrease airspeed and general airplane performance. It is always wise to avoid icing conditions, if practical.



● *IF THE ENGINE INERTIAL SEPARATOR IS NOT POSITIONED TO BYPASS, MOISTURE MAY COLLECT UNDER THE ENGINE INLET SCREEN AND FREEZE. SUBSEQUENTLY, THIS ICE MAY SEPARATE AFTER ENCOUNTERING HIGHER OUTSIDE TEMPERATURES WHICH COULD RESULT IN ENGINE DAMAGE.*

● *SURFACE DEICE BOOT ACTUATION BELOW -40 DEGREES CELSIUS CAN RESULT IN PERMANENT DAMAGE TO THE DEICE BOOTS. ACTUATE ONLY AS NECESSARY TO REMOVE ICE BELOW -40 DEGREES CELSIUS.*

● *PROLONGED ZERO OR NEGATIVE "G" MANEUVERS WILL STARVE THE ENGINE OIL PUMP AND RESULT IN ENGINE DAMAGE.*

CAUTION

● WHEN FLYING IN ROUGH AIR, THE FUEL AUXILIARY BOOST PUMPS WILL ACTIVATE AUTOMATICALLY WHEN THE HOPPER FUEL FLOAT SWITCHES SENSE A FUEL LEVEL BELOW APPROXIMATELY 230 POUNDS PER TANK. IF "TRANSFER FAIL" ANNUNCIATOR LIGHT DOES NOT GO OFF, POSITION THE FUEL AUXILIARY BOOST SWITCH TO "ON". POSITION THE IGNITOR SWITCH TO "ON" IN ROUGH AIR AT FUEL QUANTITIES BELOW 50 POUNDS PER TANK.

● IGNITION SHOULD BE TURNED ON WHEN FLYING IN HEAVY PRECIPITATION.

DESCENT

1. Cabin Heat Source Selector and Cabin Heat Controls - AS DESIRED.
2. Defroster Knob - PULL.
 - a. If heating/defrosting are desired:
 - (1) Cabin Heat Source Select - BOTH.
 - (2) Cabin Heat Auto Control - ROTATE AS DESIRED.
 - (3) Defrost and Cockpit/Cabin Air Knobs - AS DESIRED.

NOTE

Manual Cabin Heat Control will open and close the temperature control valve faster than Auto Cabin Heat Control.

3. Fuel Crossfeed Selector - OFF.
4. Autofeather - ARM.
5. Ice Protection - AS REQUIRED.
6. Cowl Flaps - AS REQUIRED (Open if descending into warm air).
7. Altimeter - SET.
8. Passenger Advisory Lights - AS REQUIRED
9. Seat Belts and Shoulder Harness - SECURE.

During descents with progressive power reductions, the synchrophaser may remain engaged. Before large propeller revolutions per minute changes, the synchrophaser should be positioned to OFF. Manually synchronize the propellers, then select the ON position of the synchrophaser.

To prevent confusion in interpreting which 10,000-foot segment of altitude is being displayed on the altimeter, a striped warning segment is exposed on the face of the copilot's altimeter at all altitudes below 10,000 feet.

If fuel has been consumed at uneven rates between the two tanks because of prolonged one engine inoperative flight, it is desirable to balance the fuel load by operating both engines from the fullest tank. Fuel balancing will occur fairly rapidly when crossfeeding as both engines will receive fuel from the fullest tank plus fuel will be transferred to the lightest tank at 500 to 800 pounds per hour. If there is sufficient fuel in both tanks, even though they may have unequal quantities, it is important to position the crossfeed selector to OFF for the landing.

BEFORE LANDING

1. Wing Flaps - T.O. or APPR below 200 KIAS.
2. Fuel Quantity and Balance - CHECK. Maintain lateral balance within 300 pounds differential.
3. Fuel Crossfeed Selector - OFF.
4. Landing Gear - Down below 180 KIAS. Check down lights - ON; unlocked light - OFF.
5. Wing Flaps - LAND.
6. Landing and Taxi Lights - AS REQUIRED.
7. Propeller Synchrophaser - OFF.
8. Propeller Control Levers - FORWARD.
9. Autopilot/Yaw Damper - OFF (if installed).
10. Wing Flaps - LAND below 180 KIAS
11. Approach Speed - 101 KIAS.

| |
|----------------|
| WARNING |
|----------------|

***DO NOT RAISE REVERSE TRIGGERS
IN FLIGHT.***

12. Power Levers - FLIGHT IDLE at touchdown.
13. Power Levers - GROUND IDLE after touchdown.
14. Brakes and Reverse - AS REQUIRED.

Landing gear extension before landing is easily detected by a slight change in airplane trim and a slight "bump" as the gear locks down. Illumination of the gear-down indicator lights (green) is further proof that the gear is down and locked. The gear unlocked indicator light (red) will illuminate when the gear uplocks are released and will remain illuminated while the gear is in transit. The unlocked light will extinguish when the gear has locked down. If it is reasonably certain that the gear is down and one of the gear-down indicator lights is still not illuminated, the malfunction could be caused by a burned out light bulb. This can be checked by pushing the annunciator panel press-to-test button. If the bulb is burned out, it can be replaced with the bulb from a post light. If the gear warning horn sounds at FLIGHT IDLE, the gear may not be locked down.

A simple last-minute recheck on final approach should confirm that all applicable switches are on, the gear-down indicator lights (green) are illuminated and the gear unlocked indicator light (red) is extinguished.

Landings are conventional in every respect. A power approach is used down to 50 feet above ground level using power as required to stabilize the approach speed and attitude with wing flaps fully extended, landing gear extended and airspeed of 101 KIAS. A decision must be made at the 50-foot point to complete the landing or initiate a balked landing climb using the appropriate procedure. The landing is completed by retarding the power levers and initiating a flare into the landing attitude. The airplane should touch down main wheels first slightly above stall speed. The nose is then gently lowered to the runway, power levers are positioned to GND IDLE and brakes applied as required. An abrupt power reduction could result in a hard landing. Landings on rough or soft runways are done in a similar manner except that the nosewheel is lowered to the runway at a lower speed to prevent excessive nose gear loads.

For minimum distance landings, a power reduction is initiated on passing 50 feet. The power levers are retarded to FLIGHT IDLE during the landing flare. The airplane should touchdown, main wheels first, with minimum flare. The nose is then gently lowered to the runway, power levers are positioned to GRND IDLE and brakes applied as required.

Maximum braking effectiveness is obtained by applying full even pressure to the toe brakes without locking the wheels and applying full back pressure to the control column. This procedure is recommended only for emergency stops as excessive brake pad and tire wear will occur. Maximum brake wear occurs at high speed.

When a short ground run is the major consideration, retard the power levers to reverse as required. Do not exceed the maximum reverse power limits shown in Section 2. Maximum effective braking is initiated immediately while continuing to hold the control wheel full aft. If asymmetric reverse is experienced move power levers toward ground idle.

NOTE

The airplane is controllable with proper pilot technique, with only one engine/propeller fully reversed and the other engine at flight idle. The power levers should not be rapidly retarded below ground idle until symmetric response is verified.

For crosswind approaches, either the wing-low, crab or combination method may be used. After touchdown lower the nosewheel and maintain control. A straight course is maintained with the steerable nosewheel, and occasional braking if necessary. Excessive reversing on dirty runways will accelerate propeller erosion.

BALKED LANDING

1. Power Levers - ADVANCE to takeoff power.
2. Balked Landing Transition Speed - 101 KIAS.
3. Wing Flaps - T.O..

NOTE

● *Experience indicates that retracting the landing gear during an operational VFR go-ground, when an immediate landing is contemplated, has been conducive to gear up landings.*

● *Always follow the Before Landing Checklist.*

4. Landing Gear - RETRACT during IFR go-around or simulated IFR go-around after establishing a positive rate-of-climb.
5. Trim airplane for climb.
6. Airspeed - ACCELERATE to 112 KIAS (after clearing obstacles).
7. Wing Flaps - UP as soon as all obstacles are cleared and a safe altitude and airspeed are obtained.

AFTER LANDING

1. Ice Protection Equipment - OFF.
2. Pitot/Static Heat - OFF.
3. Transponder - SBY.
4. Radar - STBY (if installed).
5. Anti-Collision Lights - OFF.
6. Recognition Lights - OFF (if installed).
7. Wing Flaps - T.O.
8. Lights - AS REQUIRED.
9. Cowl Flaps - OPEN.

After leaving the active runway, the wing flaps should be retracted. Be sure the wing flaps switch is identified before retracting the wing flaps. The wing flaps are positioned to T.O. before the engines are shut down to allow a thorough preflight inspection of the flaps system before the next flight.

SHUTDOWN

1. Parking Brake - SET if brakes are cool.
2. Postflight ELT Check - COMPLETE.
3. Avionics Master Switches - OFF.
4. Inverter Switch - OFF.
5. Fuel Control Heater Switches - OFF.
6. Accessory Switches - OFF.
7. Power Levers - FLIGHT IDLE.
8. Propeller Control Levers - FEATHER.
9. ITT below 610 degrees Celsius for one minute.
10. Fuel Control Levers - CUT OFF.
11. Fuel Auxiliary Boost Pumps - OFF.
12. Generator Switches - OFF.
13. Battery Switch - OFF.

If dusty conditions exist or if the last flight of the day has been completed, install engine inlet and exhaust covers to protect the engines from debris. The covers may be installed after the engines have cooled down (ITT indicators showing "off scale" temperatures). Secure propellers to prevent windmilling with no oil pressure.

POSTFLIGHT EMERGENCY LOCATOR TRANSMITTER CHECK

1. VHF Communications Transceiver - ON and select 121.5 MHz.
2. Audio Control Panel - AS REQUIRED.

NOTE

Do not transmit on 121.5 MHz unless there is an emergency.

3. If Audible Tone Heard - Emergency Locator Transmitter Switches OFF than NORM.

As long as the function selector switch on emergency locator transmitter remains in the AUTO position, the emergency locator transmitter automatically actuates following an impact of 5 g's or more over a short period of time.

If the emergency locator transmitter can be heard transmitting, place the function selector switch in the OFF position and the tone should cease. Immediately place the function selector switch in the AUTO position to reset the emergency locator transmitter for normal operation.

ENVIRONMENTAL SYSTEMS

OXYGEN SYSTEM (If Installed)

If oxygen use is desired proceed as follows:

1. Oxygen Control Knob - PULL ON.

| |
|----------------|
| WARNING |
|----------------|

PERMIT NO SMOKING WHEN USING OXYGEN. OIL, GREASE, SOAP, LIP-STICK, LIP BALM AND OTHER FATTY MATERIALS CONSTITUTE A SERIOUS FIRE HAZARD WHEN IN CONTACT WITH OXYGEN. BE SURE HANDS AND CLOTHING ARE OIL-FREE BEFORE HANDLING OXYGEN EQUIPMENT.

2. Mask - CONNECT and put on mask.
3. Oxygen Flow Indicator - CHECK Flow (green indicates flow).
4. Disconnect hose coupling and push control knob in when not in use.

HEATING AND VENTILATING SYSTEMS

Heater Operation - Ground:

1. Starting Engine Procedures - COMPLETED.
2. Cabin Heat Source Selector - BOTH.
3. Cabin Heat Auto Control - MANUAL.

NOTE

Manual Cabin Heat Control will open and close the temperature control valve faster than Auto Cabin Heat Control.

4. Cabin Heat Manual Switch - AS DESIRED.
5. Defrost and Cockpit/Cabin Air Knobs - AS DESIRED.
6. Cabin Heat Auto Control - ROTATE AS DESIRED.

Heater Operation - Flight:

1. Cabin Heat Source Selector - BOTH.
2. Cabin Heat Auto Control - AS DESIRED.
3. Defrost and Cockpit/Cabin Air Knobs - AS DESIRED.

OTHER NORMAL PROCEDURES**FIRE DETECTION AND EXTINGUISHING SYSTEM (IF INSTALLED)**

Fire extinguisher bottle pressures will vary considerably with ambient temperature. The fire extinguisher bottle gages are calibrated to indicate proper charge based on temperature. Gage readings must be at or above the pressure corresponding to the ambient temperature to indicate a properly serviced bottle.

STALL

The stall characteristics of the airplane are conventional. Aural warning is provided by the stall warning horn between 5 and 10 KIAS above the stall in all configurations. The wing flaps UP stall is also preceded by a moderate aerodynamic buffet which increases in intensity as the stall is approached. The wing flaps LAND stall is preceded by light buffet just prior to the stall. The power-on stall occurs at a very steep pitch angle with or without flaps. It is difficult to inadvertently stall the airplane during normal maneuvering. Due to the large speed range between wing flaps UP and wing flaps LAND stall speeds, the immediate retraction of wing flaps from LAND to UP should be avoided at slow speeds. Follow all recommended procedures for wing flap retraction.

MANEUVERING FLIGHT

No aerobatic maneuvers, including spins, are approved in this airplane; however, the airplane is conventional in all respects through the maneuvering range encountered in normal flight.

NIGHT FLYING

Before starting the engines for a night flight, position the master panel lighting switch to **NIGHT** and adjust the rheostats to provide enough illumination to check all switches, controls, etc.

Navigation lights are then checked by observing reflections from the pavement or ground. The operation of the anti-collision lights should be checked by observing the reflections on the ground. After starting the engines, the retractable landing lights may be extended and checked momentarily. Returning the landing light switches to **OFF** turns the lights off, but leaves them extended.

Before taxi, the interior lighting intensity is normally decreased to the minimum at which all the controls and switches are visible. The taxi light should be turned on prior to taxiing at night.

COLD WEATHER OPERATION

Use of an APU is recommended when ambient temperatures are below 0 degrees Fahrenheit (-18 degrees Celsius).

| |
|----------------|
| WARNING |
|----------------|

***THE WINGS AND TAIL SURFACES
MUST BE CLEAR OF ICE, SNOW AND
FROST PRIOR TO TAKEOFF AS
FLIGHT CHARACTERISTICS CAN BE
ADVERSELY AFFECTED.***

During operation in cold wet weather, the possibility of brake freezing exists; therefore, special precautions should be taken. When severe icing or excessive moisture with freezing weather conditions exist, parked airplane should have brakes in "off condition" (not set). If ice is found on the brakes during preflight inspection, heat the brakes with a ground heater until the ice melts and all traces of moisture are removed. If a ground heater is not available, spray or pour isopropyl alcohol (MIL-F-5566) on the brakes to remove the ice.



*IF BRAKES ARE DEICED USING ALCOHOL,
ENSURE ALCOHOL HAS EVAPORATED
FROM THE RAMP PRIOR TO STARTING
ENGINES AS A FIRE COULD RESULT.*

If neither heat or alcohol is available, frozen brakes can sometimes be freed by actuating the brakes several times using maximum brake pressure.

When airplane is stopped on the taxiway or runway and brake freeze-up occurs, actuate the brake several times using maximum pressure. To reduce possibility of brake freeze-up during taxi operations in severe weather conditions, two taxi slowdowns (from 35 to 15 MPH) using firm brake pressure may be made permitting brakes to reach a warm condition evaporating any moisture build up within the brake.

After take off from slush-covered runways or taxiways, leave landing gear down for a short period, allowing wheels to spin. This will allow centrifugal force to throw off any accumulated slush which should preclude frozen brakes on landing. Ensure wheels are stopped before retracting the landing gear to prevent buildup of ice or slush in the wheel wells.

During cruise, electrical equipment should be managed to assure adequate generator charging throughout the flight, since cold weather adversely affects battery capacity.

Prior to landing, and with gear down, maximum brake pressure should be applied several times to alleviate any brake freeze-up caused by icing in the brake assembly during flying conditions.

AVIONICS SYSTEMS NORMAL PROCEDURES

NOTE

When operating airplanes equipped with optional ARC 1000 series avionics, refer to Section 9 for the appropriate avionics operational procedures and limitations.

1000 AUDIO CONTROL PANEL

1. VOL HDST/SPKR

Control - Initial setting of both controls at 2 o'clock position. The VOL HDST outer concentric knob sets the master volume level for the headsets. The VOL SPKR inner concentric knob sets the master volume level of the speaker.

NOTE

Set the individual volume controls of each receiver only after setting the master volume level controls on the audio control panel.

2. INTERCOM ON/OFF

Selector Switch - AS REQUIRED. When the switch is set to the ON position it provides communication between pilot and copilot without having to actuate any microphone button. In dual installations, setting either of the INTERCOM selector switches to ON provides intercommunication. During transmissions where the pilot or copilot wheel microphone buttons are pressed, the interphone function is muted.

NOTE

●*The interphone level is adjustable only through the master HDST or SPKR controls and should be adjusted from the initial 2 o'clock setting to the desired level before the individual receiver controls are set to their final desired level.*

●*The speaker interphone function should only be used with oxygen mask microphones because the normal lip microphones will cause a feedback squeal in the cockpit.*

●*Intercommunication between pilot and copilot should not be attempted using the hand-held microphone, since keying the microphone will key the transmitter for whatever Com the function selector switch is set.*

3. SPKR/OFF/HDST Receiver
Selector Switches - SELECT any of the receiver audio signals individually or in combination for simultaneous monitoring.

NOTE

Set the individual receiver volume controls at their final desired level only after establishing the interphone level with the master controls. In the event that interphone is not being utilized, set the individual receiver volume controls with the master controls at the 2 o'clock position.

4. Function Selector
Switch - AS REQUIRED. Select COM 1, 2, 3 or CABIN. The transmitter sidetone audio will be heard in the headset or speaker for the appropriately selected transmitter. In dual installations, the sidetone will only be heard by pilot and copilot when both audio control panels are set to the same transmitter selection.
5. AUTO SPKR/HDST
Selector Switch - AS REQUIRED. Selects the appropriate receiver audio or transmitter sidetone for reception on the headset or speaker. On dual installations, the pilot's control panel activates only the pilot's headset or speaker and the copilot's control panel activates only the copilot's headset or speaker.
6. Marker Beacon
HIGH/LOW/MUTE Switch - AS REQUIRED. LOW position is used during an ILS approach. MUTE position is momentary and mutes the marker beacon audio for approximately 30 seconds.

NOTE

●*The marker beacon and DME audio level is adjustable only through the master volume controls, therefore, it is important to keep the master controls within their normal operating range of approximately 2 o'clock \pm any individual comfort adjustment to take care of ambient voice level or variations in headset types (muff, single receiver, etc.)*

●*Do not operate the master volume controls at an extremely low setting while turning up the individual receiver volume controls to an extremely high setting. This could result in distortion of NAV, COM and ADF audio as well as low levels of MKR and DME audio.*

7. Cabin Communication - Cockpit communication with the cabin is accomplished by setting the function selector switch to CABIN position and actuating the hand-held microphone or boom or oxygen mask microphone. When the cabin wishes to communicate with the cockpit, actuation of the cabin-mounted microphone key lights the CABIN CALL indicator on the audio control panel to signal the cockpit. When the function selector switch is set to CABIN, communication is established between the cockpit and cabin.

400 AUTOMATIC DIRECTION FINDER

1. OFF/VOL Control - ON; ADJUST to desired listening level.
2. PRI Frequency Selectors - SELECT desired operating frequency.
3. SEC Frequency Selectors - SELECT desired operating frequency.
4. 1-2 Selector Switch - 1 position.

NOTE

The 1-2 selector switch can be placed in the "2" position for operation on secondary frequency. The reselect lamp will flash only when frequency selection is outside of operating range of the receiver.

5. ADF SPEAKER/PHONE Switch - SELECT speaker or phone position as desired.
6. ADF Pushbutton - PUSH IN and note relative bearing on ADF Indicator.
7. TEST Pushbutton - PUSH IN and hold until indicator pointer slews off indicated bearing at least 10 to 20 degrees.
8. Indicator Pointer - Observe that pointer returns to the same relative bearing as in step 1.
9. HDG Control - SET goniometer-indicator dial so that index indicates magnetic or true heading of airplane. Pointer indicates bearing to station.

NOTE

When switching stations, place function pushbutton in the REC position. Then, after station has been selected, place function pushbutton in the ADF position to resume automatic direction finder operation. This practice prevents the bearing indicator from swinging back and forth as frequency dial is rotated.

10. BFO Pushbutton - PUSH IN as required.

NOTE

A 1000-Hz tone is heard in the audio output when CW signal (Morse Code) is tuned in properly.

ELECTRIC ELEVATOR TRIM DISENGAGE CHECK

1. Operate the electric trim switch in one direction and observe motion of the manual pitch trim wheel in the proper direction. While performing the above test, momentarily depress AP/TRIM DISC switch and release. Observe that manual pitch trim wheel motion is arrested and remains stopped when the disconnect switch is released and electric trim switch is actuated.
2. Repeat Step 1. in the opposite direction.
3. Elevator Trim - SET for takeoff.

400 MARKER BEACON

1. LO/HI MKR Switch - SELECT HI position for airway flying or LO position for ILS approaches.
2. SPKR/OFF/HDST MKR Switch - SELECT speaker or headset audio.
3. VOL (HDST OR SPKR) CONTROL - ADJUST volume level.
4. Marker Beacon Test Switch - ACTUATE to ensure that marker beacon indicator lights are operative.

NOTE

●*The marker beacon and DME audio level is adjustable only through the master volume controls, therefore, it is important to keep the master controls within their normal operating range of approximately 2 o'clock ± any individual comfort adjustment to take care of ambient voice level or variations in headset types (muff, single receiver, etc.)*

●*Do not operate the master volume controls at an extremely low setting while turning up the individual receiver volume controls to an extremely high setting. This could result in distortion of NAV, COM and ADF audio as well as low levels of MKR and DME audio.*

400 NAVIGATION/COMMUNICATIONS

Pretuning Active Nav/Com Frequencies:

1. COM OFF/VOL Control - TURN ON; adjust to desired audio level.
2. FREQUENCY SELECTORS - MANUALLY ROTATE corresponding NAV or COM frequency selectors (press 25/50 pushbutton as required to select the desired third fractional COM digit) until the desired frequency is shown in the frequency readout window. The display blinks for approximately 8 seconds, indicating that the selected frequency is ready for storage in memory.
3. MEMORY 1, 2, 3
Pushbutton - PRESS the active frequency memory button as indicated by the illuminated memory bar. The display immediately stops blinking, indicating that the new frequency is stored in the active memory, and displays the new active frequency. The original active frequency is lost.

Preselecting and Storing Nav/Com Frequencies In Memory.

1. COM OFF/VOL CONTROL - TURN ON; adjust to desired audio level.
2. FREQUENCY SELECTORS - MANUALLY ROTATE corresponding NAV or Com frequency selectors (press 25/50 pushbutton as required to select the desired third fractional COM digit) until the desired frequency is shown in the frequency readout window. The display blinks for approximately 8 seconds, indicating that the selected frequency is ready for storage in memory.
3. MEMORY 1, 2, 3 Pushbuttons - PRESS the memory pushbutton of one of the NAV or COM memories not in use. The display immediately stops blinking, and displays the new frequency for 1 second to indicate that it is now stored in the selected memory. The display then reverts to indicating the active frequency.
4. Memory 1, 2, 3 Pushbuttons - REPEAT STEPS 2 and 3 to store another frequency in the second NAV or COM memory not in use.

NOTE

This presetting sequence for memory 2 or 3 does not effect communication and/or navigation operation on the original active frequency.

Recalling a Stored Frequency:

1. MEMORY 1, 2, 3 Pushbuttons - SELECT and PRESS the desired NAV or COM memory button, and observe the following:
 - a. Frequency in selected memory becomes the active frequency.
 - b. Frequency readout window indicates new active frequency.
 - c. Corresponding memory bar indicates selected memory.

Communication Receiver-Transmitter Operation

1. COM OFF/VOL Control - TURN ON.
2. XMTR SEL Switch (on audio control panel) - SET to desired 400 NAV/COM.
3. SPEAKER/PHONE Selector Switches (on audio control panel) - SET to desired mode.

4. COM Frequency Selection - **SELECT** desired operating frequency by either pressing a **COM MEMORY** 1, 2 or 3 pushbutton to recall a preset frequency, or by manually selecting the desired operating frequency using the **COM** frequency selectors and 25/50 pushbutton.

NOTE

If dual VHF communications systems are installed, improved communication with the airplane on the ground may be obtained by using the VHF COM 2 which is connected to the vertical fin antenna. Airframe masking of the RF signals from the lower fuselage antenna associated with the VHF COM 1 sometimes impairs ground communication.

5. Vol control - Adjust to desired audio level.
6. SQ Control - **ROTATE** counterclockwise to decrease background noise as required.
7. Microphone Button:
 - a. To Transmit - **PRESS**; speak into microphone.
 - b. To Receive - **RELEASE**.

Navigation Operation:

1. **COM OFF/VOL** Control - **TURN ON**; adjust to desired audio level.
2. **SPEAKER/PHONE** Selector Switches (on audio control panel) - Set to desired mode.
3. **NAV** Frequency Selection - **SELECT** desired operating frequency by either pressing a **NAV MEMORY** 1, 2 or 3 pushbutton to recall a preset frequency, or by using **NAV** frequency selector.
4. **NAV VOL** Control - **ADJUST** to desired audio level.
5. **ID-VOX-T** Switch:
 - a. To Identify Station - **SET** to **ID** to hear navigation station identifier signal.
 - b. To Filter Out Station - **SET** to **VOX** to include filter in audio circuit.

6. ARC PUSH-TO/PULL-FROM Knob (if applicable);
 - a. To Use As Conventional OBS - PLACE in center detent and select desired course.
 - b. To Obtain Bearing TO VOR Station - PUSH (ARC/PUSH-TO) knob to inner (Momentary On) position.

NOTE

ARC lamp will illuminate amber while the OBS course card is moving to center the course deviation pointer. After alignment has been achieved to reflect bearing TO VOR, automatic radial centering will automatically shut down, causing the ARC lamp to go out and the ARC knob to return to the center detent position and function as a normal OBS.

- c. To Obtain Continuous Bearing FROM VOR Station - PULL (ARC/PULL-FR) knob to outer detent.

NOTE

ARC lamp will illuminate amber; OBS course card will turn to center the course deviation pointer with a FROM flag to indicate bearing from VOR station. This system will continually drive to present the VOR radial the airplane is on until manually returned to the center detent by the pilot.

7. AP/CPLD Annunciator Light - CHECK ON (light is only operational if a 1000A Autopilot or 1000A IFCS is engaged), amber light illuminated.

VOR Self-Test Operation:

1. COM OFF/VOL Control - TURN ON.
2. NAV Frequency Selector Switches - SELECT usable VOR station signal.
3. OBS KNOB - SET for 0° course at course index; course deviation pointer centers or deflects left or right, depending on bearing of signal; NAV/TO-FROM indicator shows TO or FROM.

4. ID/VOX/T Switch - PRESS to T and HOLD at T; course deviation pointer centers, NAV/TO-FROM indicator shows FROM. AP/CPLD and XMIT annunciators are illuminated and the COM and NAV displays show 188.88 with all memory bars illuminated.
5. OBS Knob - TURN to displace course approximately 10° to either side of 0° (while holding ID/VOX/T). Course deviation pointer deflects full scale in direction corresponding to course displacement.

NOISE ABATEMENT

Increased emphasis on improving the quality of our environment requires renewed effort on the part of all pilots to minimize the effect of airplane noise on the public.

We, as pilots, can demonstrate our concern for environmental improvement by application of the following suggested procedures, and thereby tend to build public support for aviation:

1. Pilots operating airplanes under VFR over outdoor assemblies of persons, recreational and park areas, and other noise-sensitive areas should make every effort to fly not less than 2000 feet above the surface, weather permitting, even though flight at a lower level may be consistent with the provisions of government regulations.
2. During departure from or approach to an airport, climb after takeoff and descent for landing should be made so as to avoid prolonged flight at low altitude near noise-sensitive areas. Avoidance of noise-sensitive areas, if practical, is preferable to overflight at relatively low altitudes.

NOTE

The preceding recommended procedures do not apply where they would conflict with Air Traffic Control clearances or instructions, or where, in the pilot's judgment, an altitude of less than 2000 feet is necessary to adequately exercise his duty to see and avoid other airplanes.

The flyover noise level, established in compliance with FAR 36 at maximum continuous power is 72.0 dB(A).

No determination has been made by the Federal Aviation Administration that the noise level of this airplane is, or should be, acceptable or unacceptable for operation at, into, or out of any airport.

PROCEDURES FOR PRACTICE DEMONSTRATION OF V_{MCA}

Engine inoperative procedures should be practiced in anticipation of an emergency. This practice should be conducted at a safe altitude and should be started at a safe speed of at least 115 KIAS. As recovery ability is gained with practice, the starting speed may be lowered in small increments until the feel of the airplane in emergency conditions is well known. It should be noted that as the speed is reduced, directional control becomes more difficult. Emphasis should be placed on Stopping the initial large yaw angles by the IMMEDIATE application of rudder supplemented by banking slightly away from the yaw. Practice should be continued until: (1) an instinctive corrective reaction is developed and the corrective procedure is automatic and, (2) airspeed, altitude, and heading can be maintained easily while the airplane is being prepared for a climb. If a failed engine's propeller is allowed to windmill, expect rudder force and deflection required for coordination to be significantly greater.

Practice Demonstration of V_{MCA}

1. Wing Flaps - T.O.
2. Landing Gear - UP.
3. Power Levers - SET takeoff power.
4. Airspeed - V_{SSE} (98 KIAS) minimum.
5. Trim - SET for takeoff.
6. Instructor Pilot:
 - a. Power Lever of Simulated Failed Engine - IDLE.
 - b. Propeller Control Lever of Simulated Failed Engine - FEATHER.
7. Airspeed - DECREASE at approximately 1 Knot per second until reaching V_{MCA} (red radial) or stall warning, whichever occurs first.
8. Heading - MAINTAIN with rudder and 5 degrees bank towards operative engine.

V_{SSE} is used in training and is not a limitation. It is recommended, however, that except for training, demonstrations, takeoffs and landings, this airplane should not be flown at a speed slower than V_{SSE} .

Under no circumstances should V_{MCA} demonstration be attempted at a speed slower than the red radial on the airspeed indicator.

Simulated Engine Failure in Takeoff Configuration

1. Wing Flaps - T.O.
2. Landing Gear - DOWN.
3. Power Levers - SET takeoff power.
4. Airspeed - 98 KIAS minimum.
5. Trim - SET for takeoff.
6. Instructor Pilot:
 - a. Power Lever of simulated failed engine - 150 foot-pounds.
7. Aileron and Rudder - AS REQUIRED to maintain straight ahead flight (3 to 4 degrees bank with 1/2 ball slip into operative engine).
8. Power Levers - TAKEOFF POWER, (failed engine, simulated takeoff power).
9. Landing Gear - UP when rate-of-climb is positive.
10. Autofeather - MONITOR for proper actuation (simulated).
11. Climb to Clear Obstacles - 102 KIAS.
12. Refer to ENGINE FAILURE AFTER ROTATION checklist.

Simulated engine failure takeoff and landing practice is most safely done with both propellers set at 1900 revolutions per minute and the simulated failed engine set at 150 foot-pounds.

FUEL CONSERVATION

Operational maintenance and record-keeping techniques, taken together, can minimize wasted fuel, extend the useful range of any airplane and result in a significant reduction in general operating costs.

On preflight inspection, entrance doors, baggage doors, emergency exits, cowl flaps and wing flaps should be checked for alignment. Any one of these items not precisely aligned will create additional drag.

Good mechanical condition of the airplane and engines is very important for efficient operation and therefore, the best use of fuel. A clean exterior, especially on the wing leading edges, results in better fuel economy.

Time spent on the ground in careful flight planning will avoid needless delays on the ground, unnecessary fuel stops and other conditions that can be wasteful of time and fuel. Plan flight in a straight line whenever possible and after takeoff, turn on course as soon as practical.

Take advantage of altitudes and favorable winds, but balance the ground speed benefits of high altitudes and winds against the extra time consumed in climbing to reach best altitude, refer to Section 5, for Fuel and Time Required Chart.

Plan flights with maximum occupancy; a little effort in coordinating and scheduling can provide many miles of travel with no additional use of fuel by filling empty seats.

Plan arrival and departure times to avoid peak hours of operation at airport. Substantial fuel can be saved by reducing the time that the airplane is operated on the ground. A call to the tower before starting engines, reduced power and a short run-up before takeoff will all result in fuel savings.

In flight, use proper climb and trim techniques, raise the landing gear and wing flaps as soon as safely practical and refer to Section 5, for cruise performance information.

When descending, stay high and avoid a far out descent. Descend at your cruise segment indicated speed with power reductions as appropriate. The reason for keeping the speed down is simply because a speed increase causes a severe drag increase and a consequent waste of energy. Delay extending the landing gear and wing flaps on final approach as late as safely practical.



**SECTION 5
PERFORMANCE**

TABLE OF CONTENTS

| | Page |
|--------------------------------------|------|
| INTRODUCTION | 5-3 |
| TECHNIQUE | 5-3 |
| SAMPLE FLIGHT | 5-7 |
| Airplane Configuration | 5-7 |
| Takeoff Airport Conditions | 5-7 |
| Cruise Conditions | 5-7 |
| Landing Airport Conditions | 5-7 |
| Sample Performance Limitations | 5-7 |
| Sample Calculations | 5-8 |

CHARTS AND GRAPHS

Figure

| | | |
|------|--|------|
| 5-1 | ONE ENGINE INOPERATIVE TAKEOFF FLIGHT PATH | 5-6 |
| 5-2 | AIRSPED CALIBRATION | 5-17 |
| 5-3 | ALTIMETER CORRECTION | 5-18 |
| 5-4 | TEMPERATURE RISE DUE TO RAM RECOVERY | 5-19 |
| 5-5 | TEMPERATURE CONVERSION FROM FAHRENHEIT TO CELSIUS | 5-20 |
| 5-6 | ISA CONVERSION AND OPERATING TEMPERATURE LIMITS | 5-21 |
| 5-7 | PRESSURE CONVERSION - INCHES OF MERCURY TO MILLIBARS | 5-22 |
| 5-8 | STALL SPEEDS | 5-23 |
| 5-9 | WIND COMPONENT | 5-24 |
| 5-10 | MINIMUM ENGINE TORQUE FOR TAKEOFF | 5-25 |
| 5-11 | MAXIMUM TAKEOFF WEIGHT TO ACHIEVE TAKEOFF CLIMB REQUIREMENTS | 5-26 |
| 5-12 | MAXIMUM TAKEOFF WEIGHT AS PERMITTED BY FIELD LENGTH REQUIRED | 5-28 |
| 5-13 | MAXIMUM TAKEOFF LIMIT AS DETERMINED BY THE DEMONSTRATED BRAKE ENERGY LIMIT | 5-31 |
| 5-14 | TAKEOFF DISTANCE | 5-32 |
| 5-15 | ACCELERATE GO DISTANCE | 5-40 |

TABLE OF CONTENTS

| Figure | | Page |
|--------|--|-------|
| 5-16 | CLIMB GRADIENT AT V_2 - ONE ENGINE INOPERATIVE | 5-42 |
| 5-17 | RATE-OF-CLIMB - ALL ENGINES OPERATING (FLAPS - T.O.) | 5-43 |
| 5-18 | RATE-OF-CLIMB - ALL ENGINES OPERATING (FLAPS - UP)(MAXIMUM CLIMB) | 5-44 |
| 5-19 | RATE-OF-CLIMB - ONE ENGINE INOPERATIVE | 5-45 |
| 5-20 | RATE-OF-CLIMB - BALKED LANDING CLIMB | 5-46 |
| 5-21 | SERVICE CEILING - ONE ENGINE INOPERATIVE | 5-47 |
| 5-22 | TIME, FUEL AND DISTANCE TO CLIMB - MAXIMUM CLIMB | 5-48 |
| 5-23 | TIME, FUEL AND DISTANCE TO CLIMB - CRUISE CLIMB | 5-49 |
| 5-24 | MAXIMUM CRUISE POWER (1900 RPM) | 5-50 |
| 5-25 | MAXIMUM CRUISE POWER (1800 RPM) | 5-58 |
| 5-26 | MAXIMUM CRUISE POWER (1700 RPM) | 5-66 |
| 5-27 | MAXIMUM CRUISE POWER (1600 RPM) | 5-74 |
| 5-28 | MAXIMUM RANGE CRUISE PERFORMANCE (1900 RPM) | 5-82 |
| 5-29 | MAXIMUM RANGE CRUISE PERFORMANCE (1600 RPM) | 5-90 |
| 5-30 | MAXIMUM CRUISE POWER FUEL REQUIRED | 5-98 |
| 5-31 | RANGE PROFILE | 5-99 |
| 5-32 | ENDURANCE PROFILE | 5-100 |
| 5-33 | HOLDING TIME | 5-101 |
| 5-34 | TIME, FUEL AND DISTANCE TO DESCEND | 5-102 |
| 5-35 | LANDING FIELD LENGTH REQUIRED | 5-103 |
| 5-36 | LANDING DISTANCE | 5-104 |

INTRODUCTION

Section 5 contains all the performance limitations and information required to operate the airplane safely and to help you plan your flights in detail with reasonable accuracy. Safe and precise operation of the airplane requires the pilot to be thoroughly familiar with and understand the data and calculations of this section.

The data on these graphical and tabular charts have been compiled from actual flight tests, with the airplane and engines in good condition, using average pilot techniques. Note that the cruise performance data makes no allowance for wind and/or navigational errors. Allowances for start, taxi, takeoff, climb, descent and 45 minutes reserve at the particular cruise power and altitude are provided in the range profile chart, the endurance profile chart and the maximum cruise power fuel required chart.

All performance, range and endurance charts are based on the use of jet fuel with nominal fuel density of 6.70 pounds per gallon.

Refer to the following figures for operating weight limits:

1. Maximum Takeoff Weight To Achieve Takeoff Climb Requirements
2. Maximum Takeoff Weight As Permitted By The Field Length Required
3. Maximum Takeoff Weight Limit As Determined By The Demonstrated Brake Energy Limit
4. Landing Field Length Required

TECHNIQUE

REGULATORY COMPLIANCE

Information in this section is presented for the purpose of compliance with the appropriate performance criteria and certification requirements of SFAR 41.

STANDARD PERFORMANCE CONDITIONS

All performance in this manual is based on flight test data and the following conditions:

1. Power ratings include the installation, bleed air and accessory losses.
2. Full temperature accountability within the operational limits for which the airplane is certified.

NOTE

Should altitude be below the lowest altitude shown on the performance charts, use the performance at the lowest value shown.

3. Wing flap positions as follows:

| MODE | FLAP HANDLE POSITION | FLAP ANGLE |
|----------|----------------------|------------|
| TAKEOFF | T.O. | 10° |
| ENROUTE | UP | 0° |
| APPROACH | APPR | 20° |
| LANDING | LAND | 30° |

4. All takeoff and landing performance is based on a paved, dry runway.
5. The takeoff performance was obtained using the following procedures and conditions:

Accelerate Go/Takeoff Flight Path

- a. The autofeather was armed.
- b. Two engine power was set static to the setting corresponding to figure 5-10 and then the brakes were released. Power was reset as required prior to 80 KIAS if it exceeded 1350 foot-pounds.
- c. The engine has failed just prior to V_1 in that the pilot recognized the failure at V_1 .
- d. At V_R , the airplane was rotated to 7° nose up pitch attitude and rudder was applied as required to maintain heading with the wings level until reaching 400 feet.
- e. The landing gear was retracted when a positive climb rate was established.
- f. V_2 was maintained from the 50 foot point above the runway to 400 feet above ground level (AGL). Power adjustments were not made from 80 KIAS until reaching 400 feet AGL.
- g. The airplane was then accelerated to V_{YSE} at which time the flaps were retracted and the throttle was adjusted to torque or ITT limit. The airplane was trimmed and 3° bank was established with an approximate 1/2 ball slip into the operative engine indicated on the turn and bank indicator. The climb was then continued to 1000 feet AGL.

Accelerate Stop (Refer to Figure 5-12)

- a. The autofeather was armed
- b. Two engine power was set static to the setting corresponding to figure 5-10 and then the brakes were released. Power was reset as required prior to 80 KIAS if it exceeded 1350 foot-pounds.
- c. The engine has failed just prior to V_1 in that the pilot recognized the failure at V_1 .

- d. Both power levers were brought to flight idle at V_1 .
- e. Maximum effective braking was started immediately after the power levers were brought to flight idle and continued until the airplane came to a stop.

NOTE

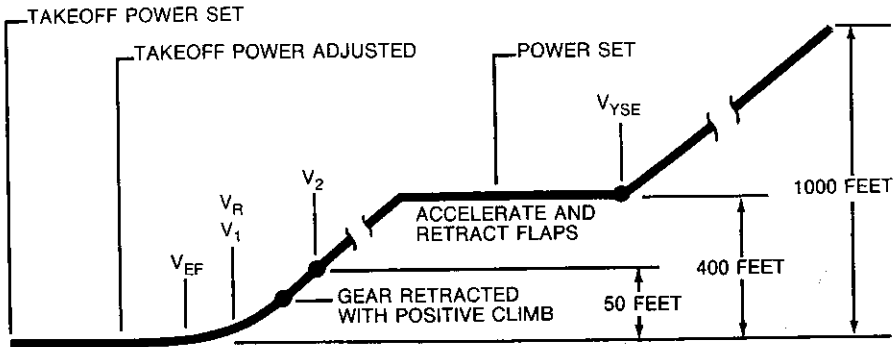
Maximum up elevator, without allowing the airplane to become airborne, allows maximum braking effectiveness.

Multiengine Takeoff

- a. The autofeather was armed
- b. The power was set prior to brake release to the setting corresponding to figure 5-10 and then the brakes were released. Power was reset as required prior to 80 KIAS if it exceeded 1350 foot-pounds.
- c. Positive rotation was made at V_R , increasing the pitch attitude by 7° and achieving the 50 foot obstacle speed given in Figure 5-14.
- d. The landing gear was retracted when a positive rate of climb was established.

Landing

- a. Landing was preceded by a steady three degree angle of approach down to the 50 foot height with airspeed at V_{REF} with flaps in the landing position and the landing gear was extended.
- b. Power was adjusted as required to maintain the three degree approach angle at V_{REF} at 50 foot point.
- c. At 50 feet, a gradual power reduction was initiated.
- d. Sink was slightly arrested, the power levers were fully retarded to flight idle and a firm touchdown was accomplished. The power levers remained at flight idle until the airplane had stopped.
- e. Maximum effective braking was initiated immediately and continued throughout the landing roll.
- f. The control wheel was held full aft to keep all the weight on the main wheels.



60856046

Figure 5-1
One Engine Inoperative Takeoff Flight Path

SAMPLE FLIGHT

The following is an example of a typical flight using the performance data contained in Figures 5-8 through 5-36. The approximation method is used in tabular performance except where noted.

AIRPLANE CONFIGURATION

| | |
|----------------------------------|-------------|
| Airplane Ramp Weight | 9075 Pounds |
| Airplane Weight at Takeoff | 9000 Pounds |
| Usable Fuel Load | 2000 Pounds |

TAKEOFF AIRPORT CONDITIONS

| | |
|-------------------------------|-------------------------|
| Field Length | 7200 Feet (Runway 23) |
| Temperature | 16 Degrees Celsius |
| Field Pressure Altitude | 2400 Feet |
| Wind | 270 degrees at 25 Knots |
| Obstacles | None |

CRUISE CONDITIONS

| | |
|-----------------------|---|
| Distance | 600 Nautical Miles |
| Cruise Altitude | 10,000 Feet |
| Temperature | -15 degrees Celsius (ISA -10 Degrees Celsius) |
| Wind | 15 Knot Tailwind |
| Power | Maximum Recommended Cruise Power |

LANDING AIRPORT CONDITIONS

| | |
|-------------------------------|-------------------------|
| Field Length | 4000 Feet (Runway 19) |
| Temperature | 7 Degrees Celsius |
| Field Pressure Altitude | 1700 Feet |
| Wind | 210 Degrees At 17 Knots |
| Landing Weight | To Be Calculated |
| Obstacles | 50-Foot Trees |

SAMPLE PERFORMANCE LIMITATIONS

- (1) Minimum Engine Torque For Takeoff
(Refer to example on Figure 5-10) - 1350 Foot-Pounds
- (2) Maximum Takeoff Weight To Achieve Takeoff Climb Requirements
(Refer to example on Figure 5-11) - 9360 Pounds

- (3) Maximum Takeoff Weight As Permitted By The Field Length Required
(Refer to example on Figure 5-12) - Not weight limited by available field length
- (4) Maximum Takeoff Weight As Determined By The Demonstrated Brake Energy Limits
(Refer to example on Figure 5-13 Example 1) - Above 9360 Pounds
- (5) Landing Field Length Required
(Refer to example on Figure 5-36) - 3900 feet with wind correction

SAMPLE CALCULATIONS

Wind Component (Figure 5-9)

- (1) The angle between the runway and the prevailing wind is 40 degrees.
- (2) Enter Figure 5-9 on the 40 degrees wind line and proceed out to the intersection with the 25-knot arc.
- (3) Read horizontally left from this intersection; the headwind component is 19 knots.

Takeoff Distance (Figure 5-14)

- (1) Enter Figure 5-14 at 9360 pounds weight; the 50-foot obstacle speed is 102 KIAS.
- (2) Proceed horizontally right from 3000-foot pressure altitude to the vertical columns for 20 degrees Celsius. The takeoff ground run is 2588 feet and the total distance required to clear a 50-foot obstacle is 3164 feet without wind correction. With a 19-knot headwind component, the corrected takeoff ground run is 2365 feet and the corrected total distance required is 2892 feet.

$$\frac{19 \text{ knots headwind}}{10 \text{ knots headwind}} (4.5 \text{ percent}) = 8.6 \text{ percent}$$

$$\begin{aligned} \text{Corrected takeoff ground run} &= 2588 \text{ feet} - [8.6 \text{ percent } (2588 \text{ feet})] \\ &= 2588 \text{ feet} - [223 \text{ feet}] \\ &= 2365 \text{ feet} \end{aligned}$$

$$\begin{aligned} \text{Corrected total distance required} &= 3164 \text{ feet} - [8.6 \text{ percent } (3164 \text{ feet})] \\ &= 3164 \text{ feet} - [272 \text{ feet}] \\ &= 2892 \text{ feet} \end{aligned}$$

Accelerate Stop Distance (Figure 5-12)

- (1) Enter Figure 5-12 at 2400 feet altitude and 16 degrees Celsius.
- (2) Proceed horizontally to right to weight reference line. Move down weight line to 9000 pounds. Proceed horizontally to right to wind reference line. Proceed down headwind line to 19 knots wind component.
- (3) Proceed horizontally to right to weight line. The accelerate-stop distance required is 3970 feet.

Accelerate Go Distance (Figure 5-15)

- (1) Enter Figure 5-15 at 9360 pounds weight; rotation speed is 98 KIAS.
- (2) Proceed horizontally right from 3000-foot pressure altitude to the vertical columns for 20 degrees Celsius. The distance required to clear a 50-foot obstacle, after rotating at 98 KIAS, is 5652 feet without wind correction. With a 19-knot headwind component, the distance can be reduced by:

$$\frac{19 \text{ knots headwind}}{10 \text{ knots headwind}} (5 \text{ percent}) = 9.5 \text{ percent}$$

$$\begin{aligned} \text{Corrected accelerate go distance} &= 5652 \text{ feet} - [9.5 \text{ percent } (5652 \text{ feet})] \\ &= 5652 \text{ feet} - [537 \text{ feet}] \\ &= 5115 \text{ feet} \end{aligned}$$

NOTE

A more exact value of the accelerate-go distance can be obtained using the interpolation method if the distance required value from the approximation method is too large.

Rate-of-Climb - All Engines Operating (Figures 5-17 and 5-18)

- (1) Enter Figure 5-18 at 16 degrees Celsius.
- (2) Proceed vertically up to the 2400-foot pressure altitude line.
- (3) Proceed horizontally right to the reference line. Follow the slope of the adjacent rate-of-climb lines until intersecting the vertical 9000-pound line.
- (4) Proceed horizontally right to obtain rate-of-climb. (1600 Feet per minute)
- (5) The climb speed for all conditions is - 109 KIAS.

Rate-Of-Climb - One Engine Inoperative (Figure 5-19)

- (1) Enter Figure 5-19 at 16 degrees Celsius.
- (2) Proceed vertically up to the 2400-foot pressure altitude line.
- (3) Proceed horizontally right to the reference line. Follow the slope of the adjacent rate-of-climb lines until intersecting the vertical 9000-pound line.
- (4) Proceed horizontally right to obtain rate-of-climb. (410 feet per minute)
- (5) The climb speed is 108 KIAS.

Time, Fuel And Distance To Climb - Cruise Climb (Figure 5-23)

Time, fuel and distance to climb are determined by finding the difference between the airport and the cruise conditions; thus, two calculations are required, one for the airport condition and the second for the cruise condition.

Airport Condition:

- (1) Enter Figure 5-23 at 16 degrees Celsius.
- (2) Proceed vertically up to 2400-foot pressure altitude line.
- (3) Proceed horizontally right to the 9000-pound line.
- (4) Proceed vertically down to obtain time to climb (1.4 minutes), fuel to climb (20 pounds) and distance to climb (3 nautical miles).

Cruise Condition:

- (5) Enter Figure 5-23 at -15 degrees Celsius.
- (6) Proceed vertically up to 10,000-foot pressure altitude line.
- (7) Proceed horizontally right to the 9000-pound line.
- (8) Proceed vertically down to obtain time to climb (5.9 minutes), fuel to climb (67 pounds) and distance to climb (15 nautical miles).

Final calculations:

| | |
|-------------------|--|
| Time to climb | = Cruise time to climb - airport time to climb |
| | = 5.9 minutes - 1.4 minutes |
| | = 4.5 minutes |
| Fuel to climb | = Cruise fuel to climb - airport fuel to climb |
| | = 67 pounds - 20 pounds |
| | = 47 pounds (add 75 pounds for start, taxi and takeoff) (122 pounds total) |
| Distance to climb | = Cruise distance to climb - airport distance to climb |
| | = 15 nautical miles - 3 nautical miles |
| | = 12 nautical miles |
| | Adjusted for wind (use 60 percent of the wind at altitude for climb wind), |
| | = 12 nautical miles \pm wind contribution |
| | = 12 + [$\frac{4.5 \text{ minutes}}{60 \text{ minutes}}$ (0.6 x 15 knots)] |
| | = 12 nautical miles + 0.7 nautical miles |
| | = 12.7 nautical miles |

Time, Fuel And Distance To Descend (Figure 5-34)

Time, fuel and distance to descend are determined by finding the difference between the cruise and the landing airport conditions; thus two calculations are required, one for the cruise condition and the second for the landing airport condition.

Cruise Condition:

- (1) Enter Figure 5-34 at the cruise altitude of 10,000 feet.
- (2) Proceed horizontally right to the guideline.
- (3) Proceed vertically down to obtain time to descend (13.3 minutes), fuel to descend (99 pounds) and distance to descend (43 nautical miles).

Landing Airport Condition:

- (4) Enter Figure 5-34 at the airport altitude of 1700 feet.
- (5) Proceed horizontally right to the guideline.
- (6) Proceed vertically down to obtain time to descend (2.0 minutes), fuel to descend (19 pounds) and distance to descend (7.0 nautical miles).

Final Calculations:

Time to descend = Cruise time to descend - airport time to descend

= 13.3 minutes - 2.0 minutes

= 11.3 minutes

Fuel to descend = Cruise fuel to descend - airport fuel to descend

= 99 pounds - 19 pounds

= 80 pounds

Distance to descend = Cruise distance to descend - airport distance to descend.

= 43 nautical miles - 7 nautical miles

= 36 nautical miles

Adjusted for wind (use 40 percent of the wind at altitude for descent wind),

= 36 ± wind contribution

= 36 + [$\frac{11.3 \text{ minutes}}{60 \text{ minutes}}$ (0.4 x 15 knots)]

= 36 nautical miles + 1.1 nautical miles

= 37.1 nautical miles

Maximum Recommended Cruise Power (Figure 5-24)

The approximation method for extracting data from the cruise tables is to select the next lower temperature and altitude values, which are generally conservative with respect to fuel economy.

- (1) Enter the ISA -10 degrees Celsius data for Maximum Recommended Cruise Power (1900 RPM) at an altitude of 10,000 feet.
- (2) Use the higher weight of 9360 pounds. The airspeed is 232 KTAS and the total fuel flow is 605 pounds per hour.
- (3) Correcting for a weight of 9000 pounds, the airspeed increases to:

$$\begin{aligned} &\text{Airspeed at the higher weight} + \left[\frac{\text{higher weight} - \text{flight weight}}{1060 \text{ pounds}} \right] \left[\text{KTAS at lower weight} - \text{KTAS at higher weight} \right] = \\ &232 \text{ KTAS} + \left[\frac{9360 \text{ pounds} - 9000 \text{ pounds}}{1060 \text{ pounds}} \right] [233 \text{ KTAS} - 232 \text{ KTAS}] = \\ &232 \text{ KTAS} + 0.3 \text{ KTAS} = 232.3 \text{ KTAS} \end{aligned}$$

The interpolation method may be used for interpolating altitude and temperature to obtain performance data closer to the actual conditions.

In the above calculations, for convenience, the weight was assumed to be equal to the takeoff weight of 9000 pounds. More realistic data can be determined if the average cruise weight is used. This average cruise weight is determined as follows:

$$\begin{aligned} \text{Cruise fuel} &= \frac{\text{Total distance} - \text{climb distance} - \text{descent distance}}{\text{true airspeed} \pm \text{wind correction}} \times [\text{total fuel flow per hour}] \\ &= \frac{600 \text{ Nautical miles} - 12.0 \text{ nautical miles} - 37.1 \text{ nautical miles}}{232.4 \text{ KTAS} + 15 \text{ knot tailwind}} \times [605 \text{ pounds per hour}] \\ &= \frac{550.9 \text{ nautical miles}}{247.4 \text{ knots}} \times 605 \text{ pounds per hour} \\ &= 2.23 \text{ hours} \times 605 \text{ pounds per hour} \\ &= 1349 \text{ pounds} \end{aligned}$$

$$\begin{aligned}\text{Average cruise weight} &= \text{Starting weight - start, taxi and climb fuel} - \frac{\text{Cruise fuel}}{2} \\ &= 9075 \text{ pounds} - 122 \text{ pounds} - \frac{1349 \text{ pounds}}{2} \\ &= 8279 \text{ pounds}\end{aligned}$$

$$\begin{aligned}\text{Average cruise speed} &= \text{True airspeed (refer to Figure 5-30) + weight correction} \\ &= 232 \text{ KTAS} + \frac{9360 \text{ pounds} - 8279 \text{ pounds}}{1060 \text{ pounds}} \quad (233 - 232 \text{ KTAS}) \\ &= 232 \text{ KTAS} + 1.0 \text{ KTAS} \\ &= 233 \text{ KTAS}\end{aligned}$$

$$\begin{aligned}\text{Average ground speed} &= 233 \text{ KTAS} + \text{tailwind} \\ &= 233 \text{ KTAS} + 15 \text{ knots} \\ &= 248 \text{ knots}\end{aligned}$$

$$\begin{aligned}\text{Distance during cruise} &= \text{Total distance} - \text{climb distance} - \text{descent distance} \\ &= 600 - 12 - 37.1 \\ &= 550.9 \text{ nautical miles}\end{aligned}$$

$$\begin{aligned}\text{Time during cruise} &= \frac{\text{Cruise distance}}{\text{ground speed}} \\ &= \frac{550.9}{248} \\ &= 2.22 \text{ hours}\end{aligned}$$

Landing Distance (Figure 5-36)

Landing weight = Starting weight - start, taxi and climb
fuel - cruise fuel - descent fuel

= 9075 pounds - 122 pounds -
1349 pounds - 80 pounds

= 7524 pounds

Wind = 210 degrees at 17 knots. Determine
headwind component (refer to Figure 5-9)
(16 knots headwind)

Enter Figure 5-36 at 8300 pounds; the approach speed is 100 IAS. Proceed horizontally right from 2000-foot pressure altitude to the vertical column for 10 degrees Celsius. The landing distance ground roll is 1425 feet and the total distance required to clear a 50-foot obstacle is 2659 feet without wind correction. With a 16-knot headwind component, the corrected ground roll distance is 1311 feet and the corrected total distance required is 2446 feet.

$$\frac{16 \text{ knots headwind}}{10 \text{ knots headwind}} \text{ (5 percent)} = 8.0 \text{ percent}$$

Corrected landing
ground roll = 1425 feet - [8.0 percent (1425)]

= 1425 feet - 114 feet

= 1311 feet

Corrected total
distance required = 2659 - [8.0 percent (2659)]

= 2659 feet - 213 feet

= 2446 feet

Rate-Of-Climb - Balked Landing Climb (Figure 5-20)

- (1) Enter Figure 5-20 at 7 degrees Celsius.
- (2) Proceed vertically up to the 1700-foot pressure altitude line.
- (3) Proceed horizontally right to the weight reference line. Follow the guidelines up and to the right until intersecting the vertical 7524-pound weight line.
- (4) Proceed horizontally right to determine the rate-of-climb. (1600 feet per minute)

Climb speed = 100 KIAS for all weights and altitudes.

$$\begin{aligned} \text{Total fuel required} \\ \text{(without holding fuel)} &= \text{Start, taxi and climb fuel} \\ &\quad + \text{cruise fuel} + \text{descent fuel} \\ &= 122 \text{ pounds} + 1349 \text{ pounds} \\ &\quad + 80 \text{ pounds} \\ &= 1551 \text{ pounds} \end{aligned}$$

Holding Time (Figure 5-33)

The holding fuel required for 45 minutes at 10,000 feet is as follows:

- (1) Enter Figure 5-33 at 0.75 hours.
- (2) Proceed horizontally right to the altitude guideline of 10,000 feet.
- (3) Proceed vertically downward to obtain the holding fuel required (226 pounds).

$$\begin{aligned} \text{Total fuel required} \\ \text{(with 45 minutes} \\ \text{holding fuel)} &= \text{Total fuel required without holding fuel} \\ &\quad + \text{holding fuel required for 45 minutes.} \\ &= 1551 \text{ pounds} + 226 \text{ pounds} \\ &= 1777 \text{ pounds} \end{aligned}$$

To determine holding time, the fuel available for holding must be determined.

$$\begin{aligned} \text{Fuel} \\ \text{available} \\ \text{for} \\ \text{holding} &= \text{Initial fuel} - \text{start, taxi and climb} \\ &\quad \text{fuel} - \text{cruise fuel} - \text{descent fuel} \\ &= 2000 \text{ pounds} - 122 \text{ pounds} \\ &\quad - 1349 \text{ pounds} - 80 \text{ pounds} \\ &= 449 \text{ pounds} \end{aligned}$$

- (1) Enter Figure 5-33 at 449 pounds of fuel available.
- (2) Proceed vertically up to the intersection with the guideline for 10,000 feet.
- (3) Proceed horizontally left to obtain holding time available. (1.5 hours)

NOTE:

1. Indicated Airspeed Assumes Zero Instrument Error.
2. The Following Calibrations Are Not Valid In Prestall Buffet.

FLIGHT CALIBRATION

| GEAR - UP FLAPS - UP | | GEAR - UP or DOWN FLAPS - T.O. | | GEAR - DOWN FLAPS - APPR | | GEAR - DOWN FLAPS - LAND | |
|-------------------------|------|-----------------------------------|------|-----------------------------|------|-----------------------------|------|
| CIAS | KCAS | CIAS | KCAS | CIAS | KCAS | CIAS | KCAS |
| -- | -- | 80 | 82 | 80 | 82 | 80 | 80 |
| -- | -- | 90 | 92 | 90 | 91 | 90 | 90 |
| 100 | 102 | 100 | 101 | 100 | 100 | 100 | 99 |
| 110 | 112 | 110 | 111 | 110 | 110 | 110 | 109 |
| 120 | 121 | 120 | 121 | 120 | 120 | 120 | 118 |
| 140 | 141 | 140 | 141 | 140 | 139 | 140 | 137 |
| 160 | 161 | 160 | 161 | 160 | 158 | 160 | 157 |
| 180 | 181 | 180 | 181 | 180 | 178 | 180 | 177 |
| 200 | 201 | 200 | 201 | 200 | 198 | -- | -- |
| 220 | 221 | -- | -- | -- | -- | -- | -- |
| 229 | 230 | -- | -- | -- | -- | -- | -- |

EXAMPLE:

Indicated Airspeed - 204 KIAS
Landing Gear - Up
Flaps - Up

Calibrated Airspeed - 205 KCAS

GROUND CALIBRATION

| FLAPS - T.O. | |
|--------------|------|
| CIAS | KCAS |
| 60 | 63 |
| 70 | 73 |
| 80 | 83 |
| 90 | 92 |
| 100 | 102 |
| 110 | 112 |

**Figure 5-2
AIRSPEED CALIBRATION
PILOT'S AND COPILOT'S SYSTEMS**

NOTE:

1. Indicated airspeed and indicated altitude assume zero instrument error.
2. Add correction to indicated altimeter reading to obtain corrected altitude.
3. The following calibrations are valid for the pilots and copilot's altimeters.

| GEAR FLAPS | SEA LEVEL | | | | 15,000 FEET | | | |
|------------|-----------|-----------|-----------|-----------|-------------|-----------|-----------|-----------|
| | UP UP | DOWN T.O. | DOWN APPR | DOWN LAND | UP UP | DOWN T.O. | DOWN APPR | DOWN LAND |
| KIAS | FEET | FEET | FEET | FEET | FEET | FEET | FEET | FEET |
| 80 | -- | 14 | 11 | 1 | -- | 23 | 17 | 2 |
| 90 | -- | 13 | 6 | -4 | -- | 20 | 10 | -6 |
| 100 | 16 | 13 | -2 | -10 | 26 | 20 | -3 | -16 |
| 110 | 15 | 12 | -4 | -17 | 24 | 19 | -6 | -27 |
| 120 | 13 | 12 | -9 | -22 | 21 | 19 | -14 | -34 |
| 140 | 13 | 13 | -18 | -33 | 20 | 20 | -28 | -52 |
| 160 | 15 | 15 | -26 | -41 | 23 | 23 | -42 | -65 |
| 180 | 17 | 17 | -31 | -50 | 26 | 26 | -50 | -79 |
| 200 | 19 | 19 | -37 | -- | 29 | 29 | -59 | -- |
| 220 | 21 | -- | -- | -- | 33 | -- | -- | -- |
| 229 | 22 | -- | -- | -- | 34 | -- | -- | -- |

| GEAR FLAPS | 30,000 FEET | | | |
|------------|-------------|-----------|-----------|-----------|
| | UP UP | DOWN T.O. | DOWN APPR | DOWN LAND |
| KIAS | FEET | FEET | FEET | FEET |
| 80 | -- | 38 | 29 | 4 |
| 90 | -- | 34 | 17 | -11 |
| 100 | 43 | 34 | -5 | -26 |
| 110 | 40 | 32 | -11 | -45 |
| 120 | 35 | 32 | -23 | -58 |
| 140 | 34 | 34 | -47 | -88 |
| 160 | 39 | 39 | -70 | -109 |
| 180 | 44 | 44 | -84 | -132 |
| 200 | 50 | 50 | -99 | -- |
| 220 | 55 | -- | -- | -- |
| 229 | 58 | -- | -- | -- |

EXAMPLE :

Airspeed - 160 KIAS.
 Indicated Altitude - 12,000 Feet.
 Configuration - Gear Up And Flaps Up.

Correction - 21 Feet.
 Corrected Altitude - 12,000 Feet + (21) Feet = 12,021 Feet.

Figure 5-3
ALTIMETER CORRECTION
PILOT'S AND COPILOT'S SYSTEMS

57847065

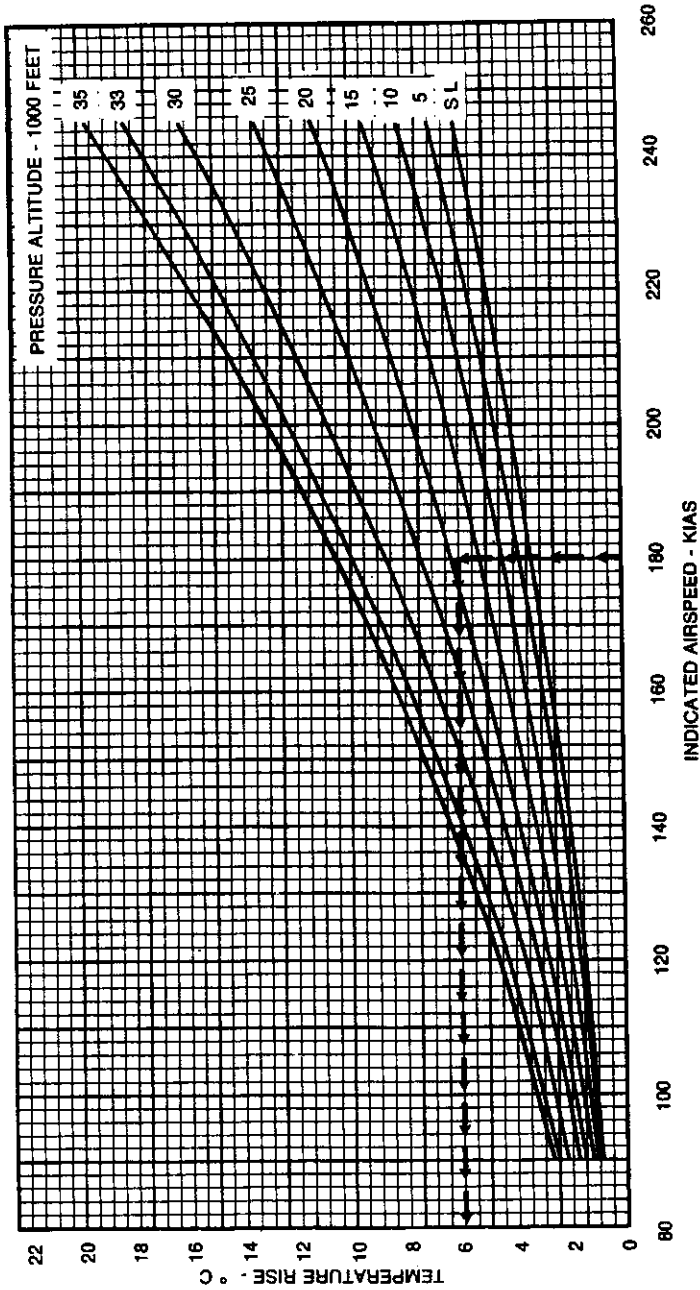
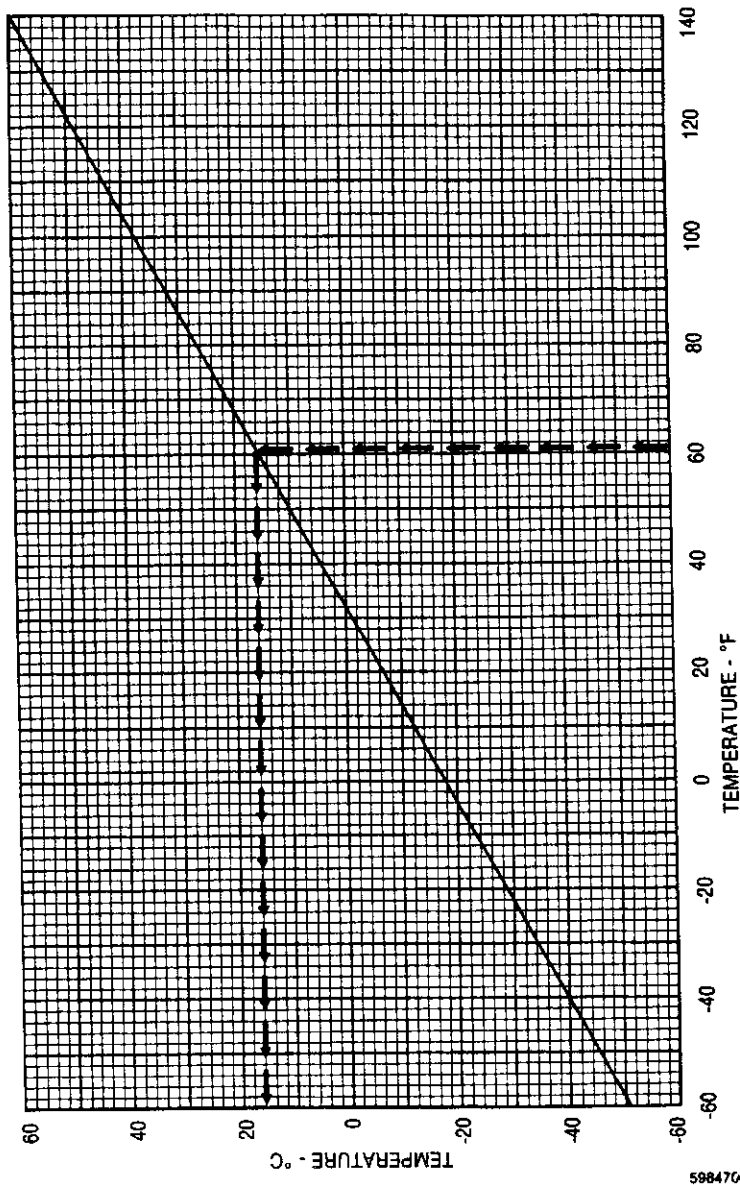


Figure 5-4
TEMPERATURE RISE DUE TO RAM RECOVERY

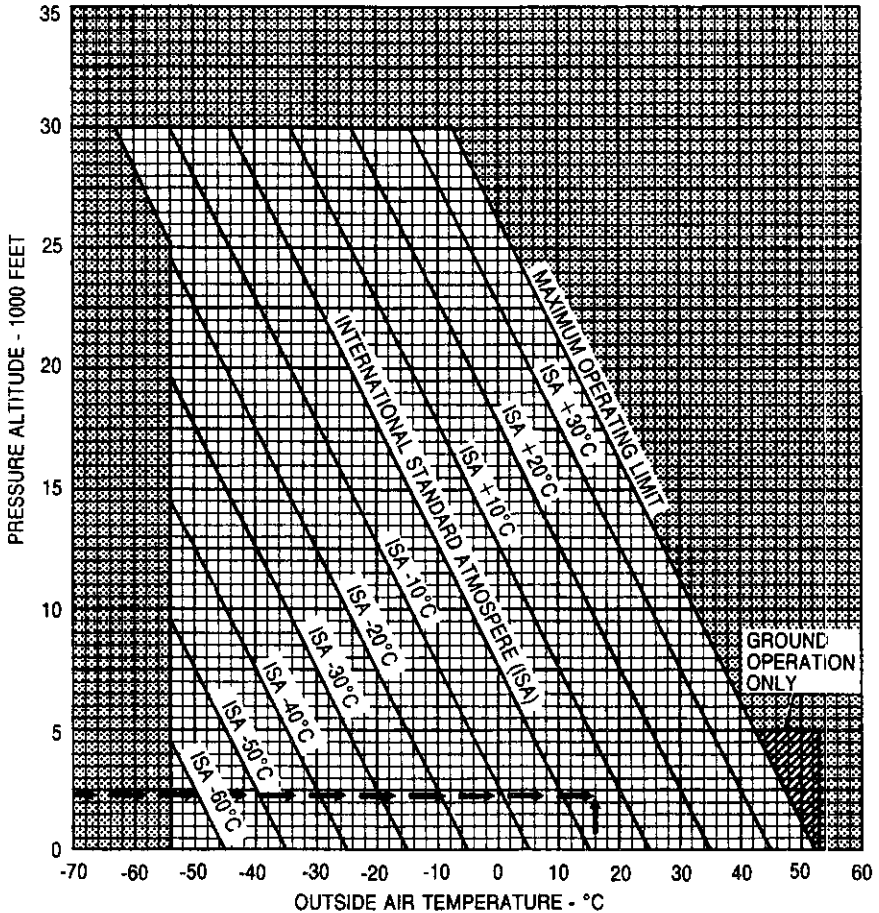


59847004

EXAMPLE:
Temperature - 61 Degrees Fahrenheit.
Temperature - 16 Degrees Celsius.

Figure 5-5
TEMPERATURE CONVERSION FROM FAHRENHEIT TO
CELSIUS

NOTE:
Do not operate in shaded area of chart.

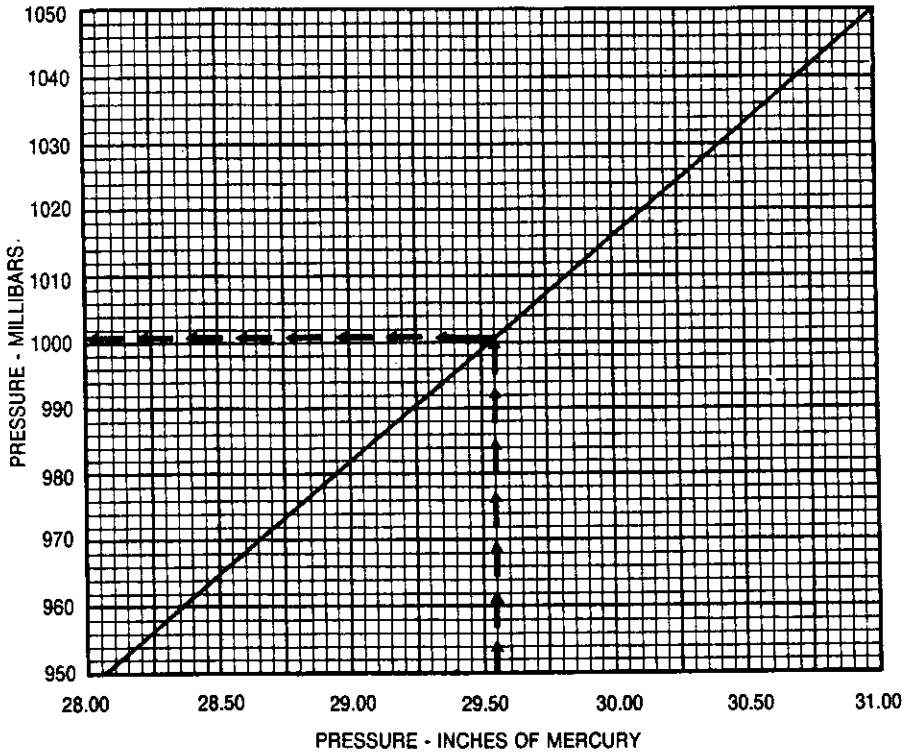


EXAMPLE:
Temperature - 16 Degrees Celsius.
Pressure Altitude - 2400 Feet.

Temperature - ISA +5 degrees Celsius.

59647015

**Figure 5-6
ISA CONVERSION
AND OPERATING TEMPERATURE LIMITS**



EXAMPLE:
Pressure - 29.55 Inches of Mercury.

Pressure - 1000.6 Millibars.

59847002

Figure 5-7
PRESSURE CONVERSION
INCHES OF MERCURY TO MILLIBARS

CONDITIONS:

1. Power Levers - Flight Idle.

NOTE:

1. Maximum altitude loss during a conventional stall is 520 feet.
2. Maximum nose down pitch attitude and altitude loss during recovery from one engine inoperative stall per FAR 23.205 are approximately 7 degrees below the horizon and 700 feet, respectively.

| WEIGHT POUNDS | CONFIGURATION | | ANGLE-OF-BANK | | | | | | | |
|---------------|---------------|------|---------------|------|------|------|------|------|------|------|
| | | | 0° | | 30° | | 45° | | 60° | |
| | FLAPS | GEAR | KIAS | KCAS | KIAS | KCAS | KIAS | KCAS | KIAS | KCAS |
| 9360 | UP | UP | 95 | 95 | 102 | 102 | 113 | 113 | 134 | 134 |
| | T.O. | DOWN | 85 | 85 | 91 | 91 | 101 | 101 | 120 | 120 |
| | APPR | DOWN | 81 | 81 | 87 | 87 | 96 | 96 | 115 | 115 |
| | LAND | DOWN | 75 | 77 | 81 | 83 | 90 | 92 | 107 | 109 |
| 8300 | UP | UP | 90 | 90 | 97 | 97 | 107 | 107 | 127 | 127 |
| | T.O. | DOWN | 82 | 82 | 88 | 88 | 98 | 98 | 116 | 116 |
| | APPR | DOWN | 79 | 79 | 85 | 85 | 94 | 94 | 112 | 112 |
| | LAND | DOWN | 74 | 76 | 80 | 82 | 88 | 90 | 105 | 107 |
| 7300 | UP | UP | 86 | 86 | 92 | 92 | 102 | 102 | 122 | 122 |
| | T.O. | DOWN | 78 | 78 | 84 | 84 | 93 | 93 | 110 | 110 |
| | APPR | DOWN | 77 | 77 | 83 | 83 | 92 | 92 | 109 | 109 |
| | LAND | DOWN | 73 | 75 | 79 | 81 | 87 | 89 | 104 | 106 |
| 6300 | UP | UP | 81 | 81 | 87 | 87 | 96 | 96 | 115 | 115 |
| | T.O. | DOWN | 75 | 75 | 81 | 81 | 89 | 89 | 106 | 106 |
| | APPR. | DOWN | 74 | 74 | 80 | 80 | 88 | 88 | 105 | 105 |
| | LAND. | DOWN | 72 | 74 | 78 | 80 | 86 | 88 | 103 | 105 |

EXAMPLE:

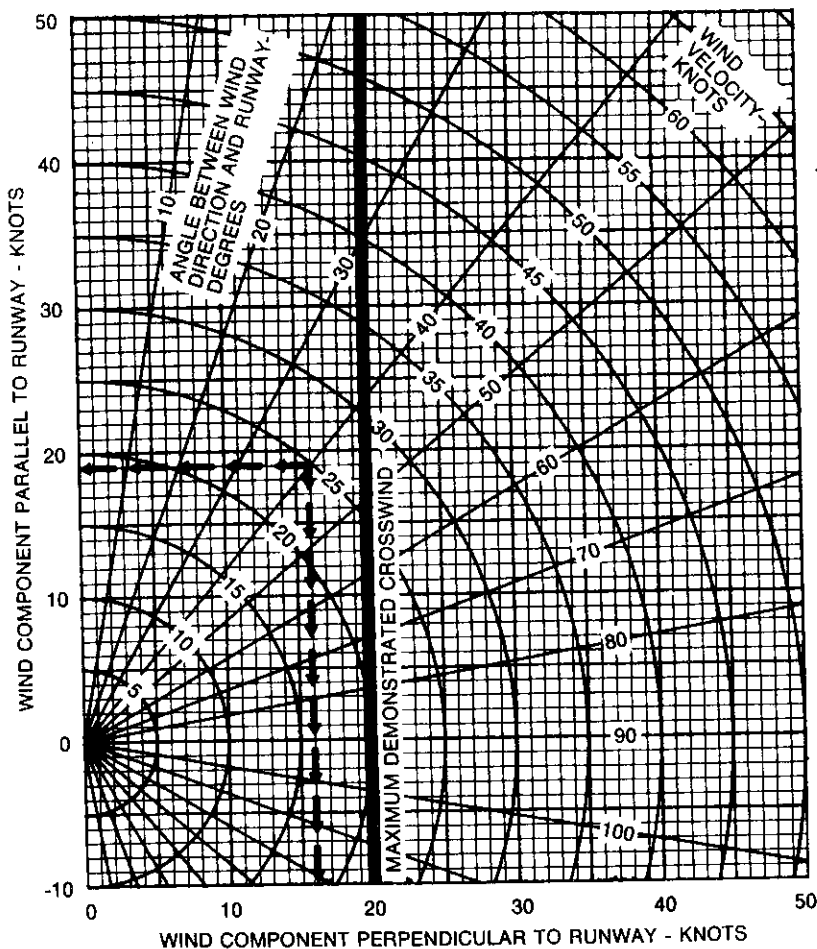
Weight - 9000 Pounds.
 Landing Gear - Up.
 Wing Flaps - Up.
 Angle-of-Bank - 15 Degrees.

Stall Speed - 96 KIAS.
 Stall Speed - 96 KCAS.

**Figure 5-8
STALL SPEEDS**

NOTE

*Demonstrated Crosswind Velocity is 20 knots
(not a limitation).*



55857021

EXAMPLE :
Wind Velocity - 25 Knots At An Angle Of 40 Degrees.

Headwind Component - 19 Knots.
Crosswind Component - 16 Knots.

Figure 5-9
WIND COMPONENT

1900 RPM

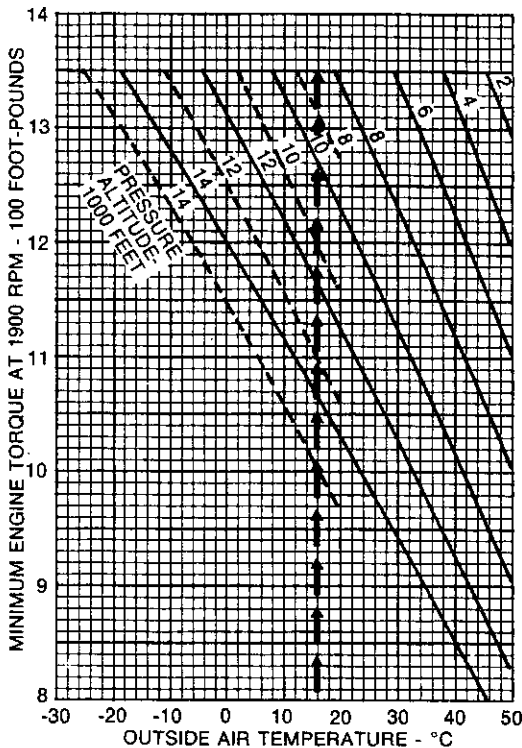
CONDITIONS:

1. Airspeed - 0 to 80 KIAS.
2. Inertial Separators - Normal.
3. Heater - As Noted.

NOTES:

1. Above 80 KIAS allow torque to increase not to exceed 1382 foot-pounds or ITT limit.
2. The torque indicated below is the minimum value for which takeoff performance in this section can be obtained.
3. Torque on this chart shall be achieved without exceeding 725 degrees Celsius ITT or 101.6% Ng.
4. For operation with inertial separator in bypass, add 5 degrees Celsius to the actual outside air temperature before entering graph.

--- Heater - ON
 — Heater - OFF



60856037

EXAMPLE:

Outside Air Temperature - 16 Degrees Celsius.
 Pressure Altitude - 2400 Feet.

Minimum Engine Torque Acceptable During Ground Run - 1350 Foot-Pounds.

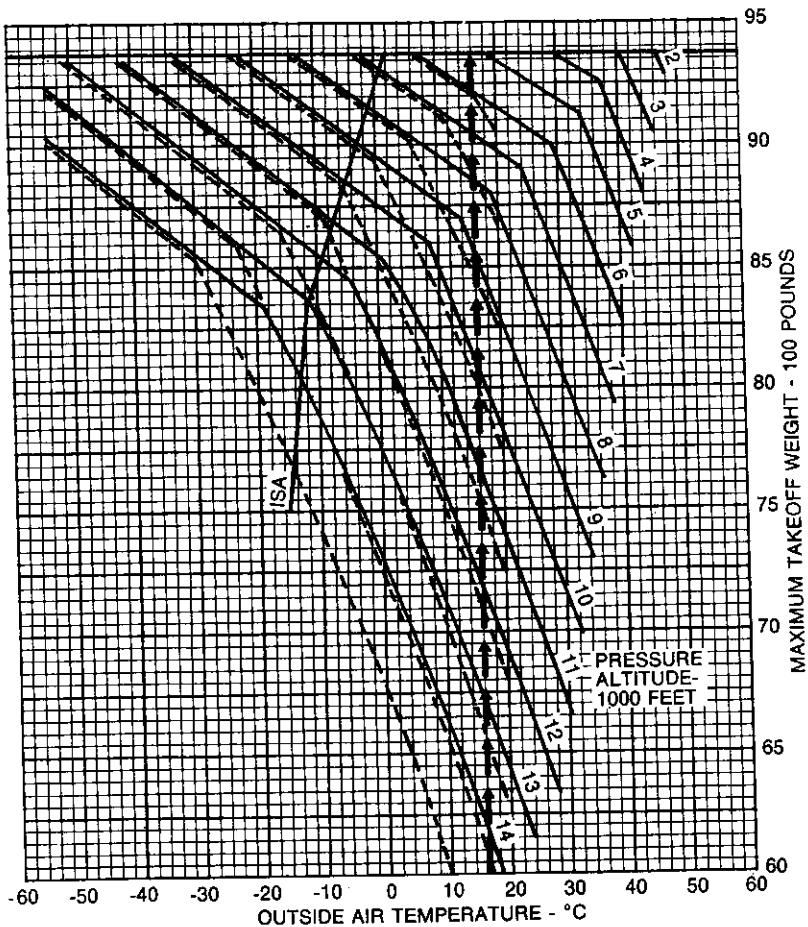
**Figure 5-10
 MINIMUM ENGINE TORQUE FOR TAKEOFF**

INERTIAL SEPARATORS - NORMAL

NOTE:

1. Use dashed lines for takeoff with heater on.

--- Heater - ON
— Heater - OFF



EXAMPLE:

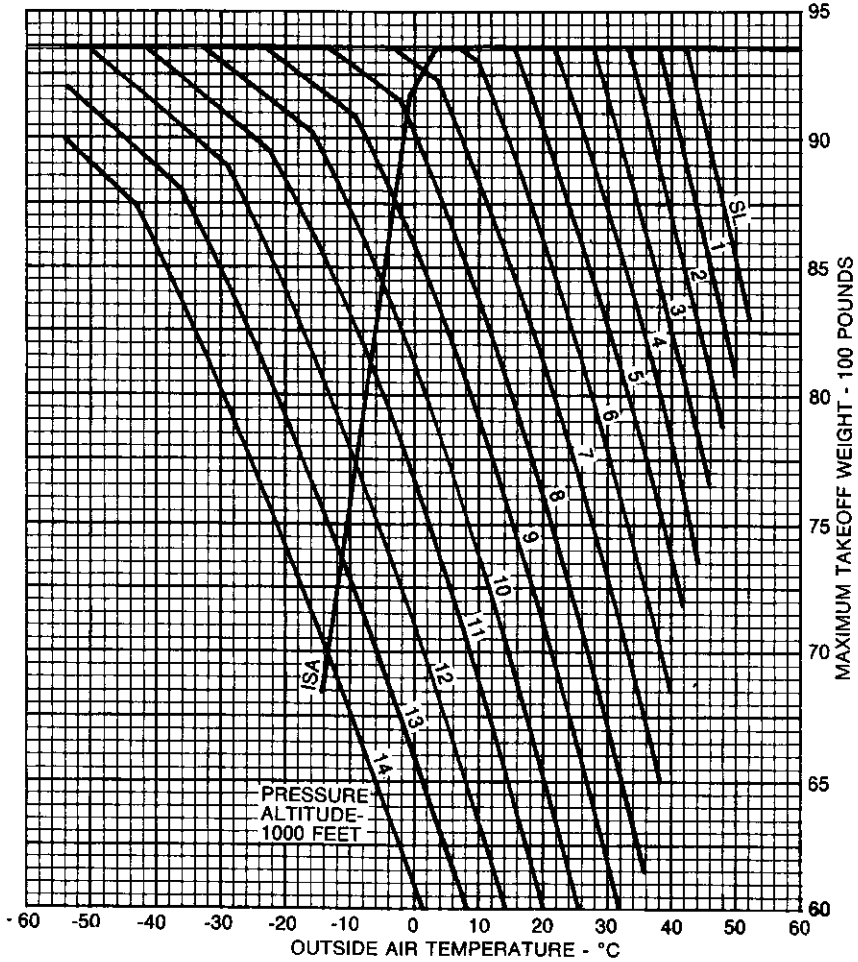
Heater - Off.
Outside Air Temperature - 16 Degrees Celsius.
Pressure Altitude - 2400 Feet.

60856038

Maximum Takeoff Weight - 9360 Pounds.

**Figure 5-11 (Sheet 1 of 2)
MAXIMUM TAKEOFF WEIGHT TO ACHIEVE
TAKEOFF CLIMB REQUIREMENTS**

INERTIAL SEPARATORS - BYPASS



60856039

Figure 5-11 (Sheet 2 of 2)
MAXIMUM TAKEOFF WEIGHT TO ACHIEVE
TAKEOFF CLIMB REQUIREMENTS

INERTIAL SEPARATORS - NORMAL (V₁ - 98 KIAS)

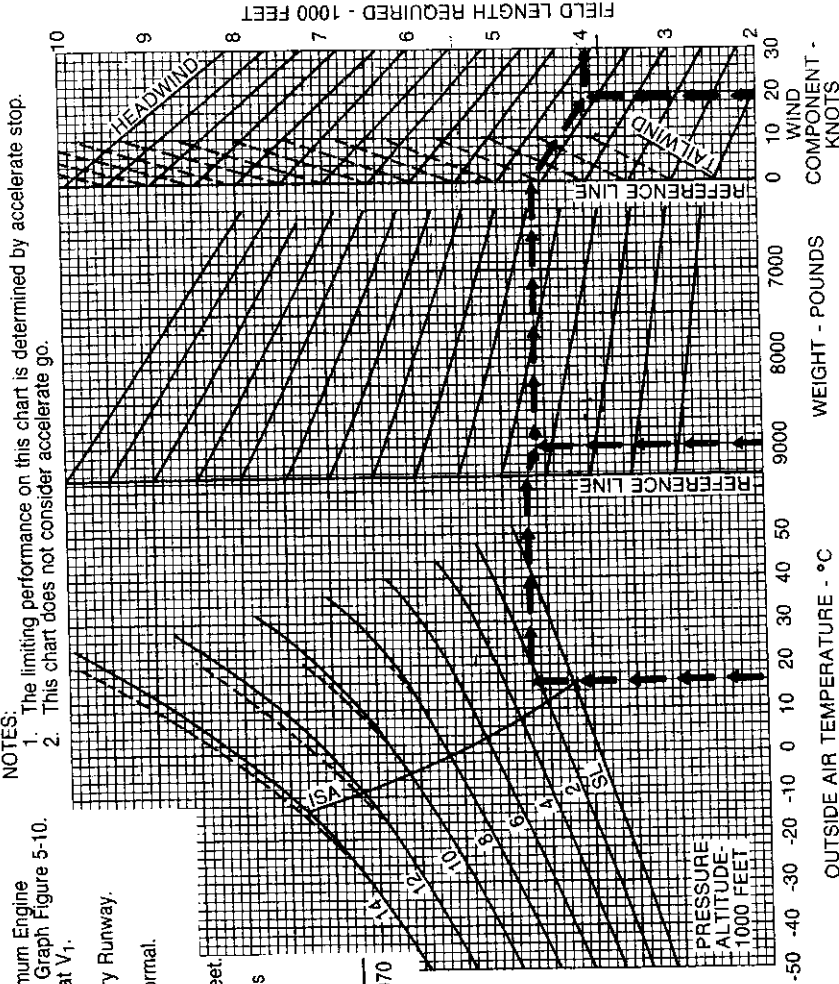
CONDITIONS:

1. Power
 - a. Set - Refer to Minimum Engine Torque for Takeoff Graph Figure 5-10.
 - b. Both Engines Idle at V₁.
2. Wing Flaps - T.O.
3. Level, Hard Surface, Dry Runway.
4. Cowl Flaps - Open.
5. Inertial Separators - Normal.
6. Heater - As Shown.

EXAMPLE:

Pressure Altitude - 2400 Feet
 Outside Air Temperature - 16 Degrees Celsius
 Wind - 19 Knot Headwind Component
 Weight - 9000 Pounds
 Field Length Required - 3970 Feet

--- Heater - ON
 — Heater - OFF



- NOTES:**
1. The limiting performance on this chart is determined by accelerate stop.
 2. This chart does not consider accelerate go.

**Figure 5-12 (Sheet 1 of 2)
 MAXIMUM TAKEOFF WEIGHT AS PERMITTED
 BY FIELD LENGTH REQUIRED
 (ACCELERATE STOP DISTANCE)**

60856040

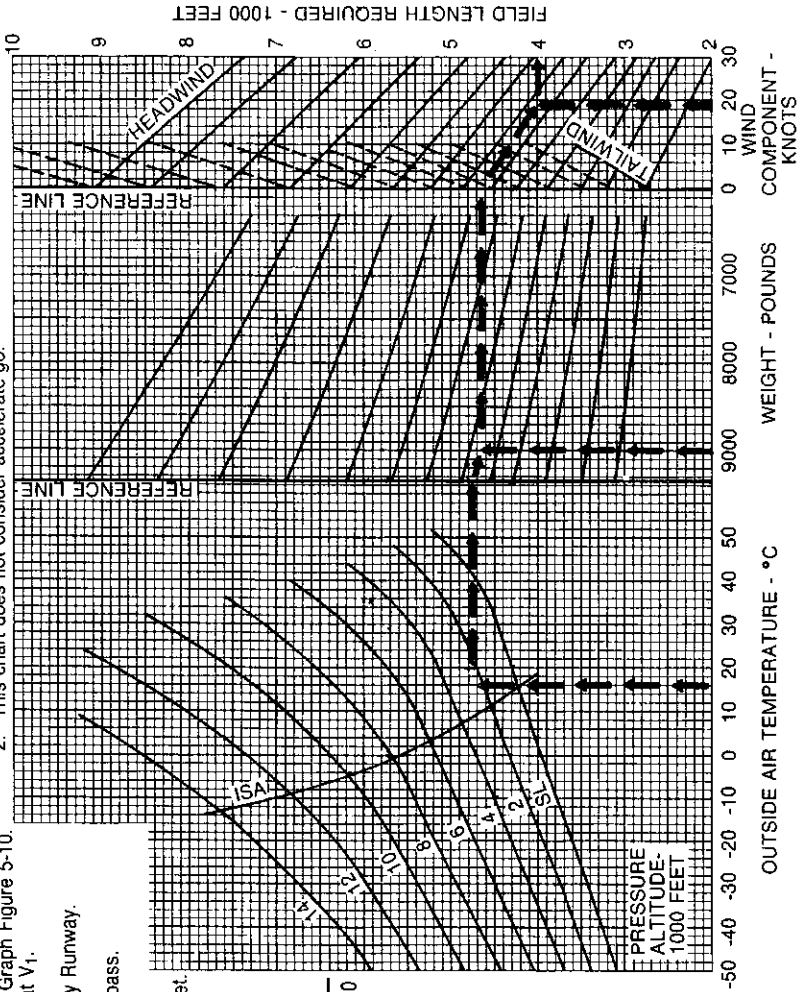
INERTIAL SEPARATORS - BYPASS (V₁ - 98 KIAS)

CONDITIONS:

1. Power
 - a. Set - Refer to Minimum Engine Torque for Takeoff Graph Figure 5-10.
 - b. Both Engines Idle at V₁.
2. Wing Flaps - 10.
3. Level, Hard Surface, Dry Runway.
4. Cowling Flaps - Open.
5. Inertial Separators - Bypass.
6. Heater - On.

NOTES:

1. The limiting performance on this chart is determined by accelerate stop.
2. This chart does not consider accelerate go.



EXAMPLE:

Pressure Altitude - 2400 Feet.
 Outside Air Temperature - 16 Degrees Celsius.
 Wind - 19 Knot Headwind Component.
 Weight - 9000 Pounds.
 Field Length Required - 4000 Feet.

**Figure 5-12 (Sheet 2 of 2)
 MAXIMUM TAKEOFF WEIGHT AS PERMITTED
 BY FIELD LENGTH REQUIRED
 (ACCELERATE STOP DISTANCE)**

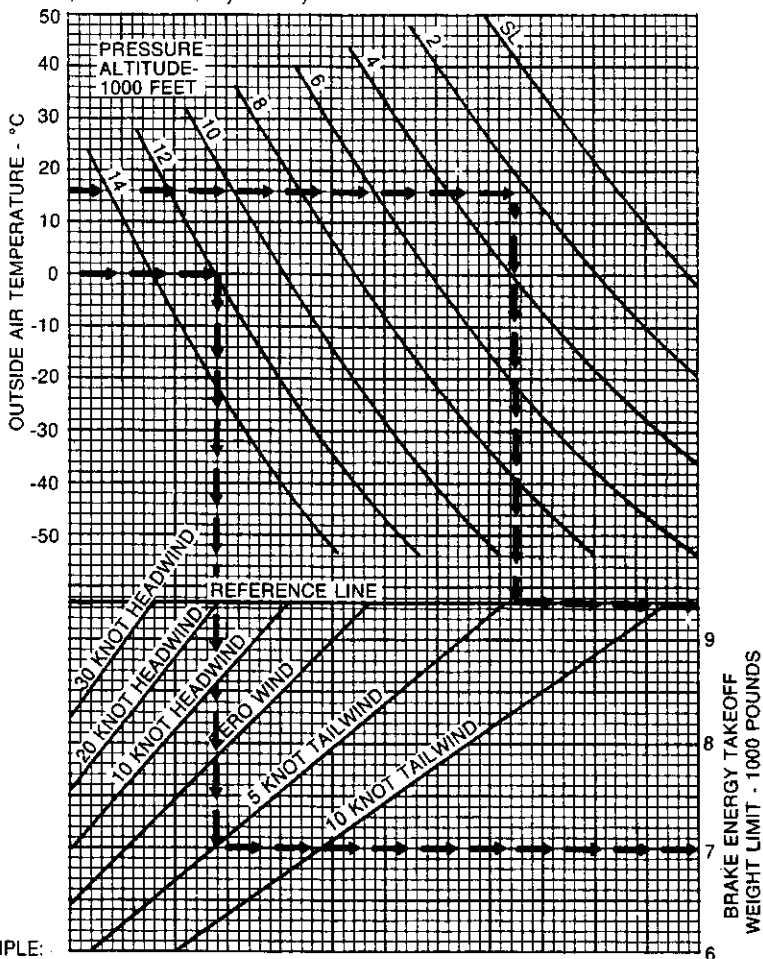
60886041

1

2

CONDITIONS:

1. Wing Flaps - T.O.
2. Ground Idle and Maximum Effective Braking at V_1 .
3. Level, Hard Surface, Dry Runway.



EXAMPLE:

1. Pressure Altitude - 2400 Feet.
Outside Air Temperature - 16 Degrees Celsius.
Wind - 19 Knot Headwind Component.

60856042

Brake Energy Takeoff Weight Limit - Above 9360 Pounds.
(The Limiting Wind For This Example Is 5.5 Knots Tailwind.)

2. Pressure Altitude - 12,000 Feet.
Outside Air Temperature - 0 Degrees Celsius.
Wind - 5 Knot Tailwind Component.

Brake Energy Takeoff Weight Limit - 7000 Pounds.

**Figure 5-13
MAXIMUM TAKEOFF WEIGHT LIMIT AS DETERMINED
BY THE DEMONSTRATED BRAKE ENERGY LIMIT**

- CONDITIONS:**
1. Takeoff Power Set - Refer To Minimum Engine Torque For Takeoff Graph Figure 5-10.
 2. Wing Flaps - T.O.
 3. Level, Hard Surface, Dry Runway.
 4. Cowl Flaps - Open.
 5. Inertial Separators - Normal.
 6. Heater - As Required.
- NOTE:**
1. Decrease total distance 4.5 percent for each 10 knots headwind.
 2. Increase total distance 25 percent for each 10 knots tailwind.
 3. With inertial separator in bypass position, add 1000 feet to altitude before entering tables. (This relationship assumes that bypass is not used above 20 degrees Celsius.)

| WEIGHT: POUNDS | V _R : KIAS | SPEED AT 50-FOOT OBSTACLE: KIAS | PRESSURE ALTITUDE: FEET | -20°C | | -10°C | | 0°C | | 10°C | | | |
|----------------|-----------------------|---------------------------------|-------------------------|-------------------|--|-------------------|--|-------------------|--|-------------------|--|------|------|
| | | | | GROUND ROLL: FEET | TOTAL DISTANCE TO CLEAR 50-FOOT OBSTACLE: FEET | GROUND ROLL: FEET | TOTAL DISTANCE TO CLEAR 50-FOOT OBSTACLE: FEET | GROUND ROLL: FEET | TOTAL DISTANCE TO CLEAR 50-FOOT OBSTACLE: FEET | GROUND ROLL: FEET | TOTAL DISTANCE TO CLEAR 50-FOOT OBSTACLE: FEET | | |
| 9360 | 98 | 102 | Sea Level | 1722 | 2180 | 1834 | 2308 | 1947 | 2437 | 2062 | 2569 | 2062 | 2569 |
| | | | 1000 | 1826 | 2299 | 1943 | 2433 | 2062 | 2569 | 2183 | 2706 | 2183 | 2706 |
| | | | 2000 | 1935 | 2424 | 2060 | 2566 | 2185 | 2707 | 2312 | 2852 | 2312 | 2852 |
| | | | 3000 | 2052 | 2557 | 2182 | 2704 | 2313 | 2853 | 2450 | 3008 | 2450 | 3008 |
| | | | 4000 | 2175 | 2696 | 2312 | 2851 | 2452 | 3010 | 2598 | 3175 | 2598 | 3175 |
| | | | 5000 | 2306 | 2845 | 2451 | 3009 | 2602 | 3180 | 2755 | 3354 | 2755 | 3354 |
| | | | 6000 | 2446 | 3004 | 2601 | 3179 | 2762 | 3362 | 2927 | 3550 | 2927 | 3550 |
| | | | 7000 | 2597 | 3174 | 2763 | 3362 | 2934 | 3557 | 3113 | 3760 | 3113 | 3760 |
| | | | 8000 | 2759 | 3358 | 2937 | 3560 | 3124 | 3773 | 3315 | 3990 | 3315 | 3990 |
| | | | 9000 | 2936 | 3559 | 3128 | 3777 | 3328 | 4004 | 3588 | 4302 | 3588 | 4302 |
| | | | 10,000 | 3127 | 3776 | 3334 | 4011 | 3550 | 4257 | 3550 | 4257 | | |
| | | | 11,000 | 3334 | 4010 | 3558 | 4265 | 3875 | 4633 | 3875 | 4633 | | |
| | | | 12,000 | 3559 | 4267 | 3819 | 4561 | 4276 | 5124 | 4276 | 5124 | | |
| | | | 13,000 | 3805 | 4547 | 4206 | 5027 | 4729 | 5682 | 4729 | 5682 | | |
| | | | 14,000 | 4157 | 4957 | 4651 | 5566 | 5241 | 6321 | 5241 | 6321 | | |

EXAMPLE:
 Takeoff Weight - 9000 Pounds.
 Outside Air Temperature - 16 Degrees Celsius.
 Pressure Altitude - 2400 Feet.
 Headwind Component - 19 Knots.
 Ground Run (Approximation Method) - 2588 Feet (2365 Feet With Wind Correction).
 Total Distance Required (Approximation Method) - 3164 Feet (2892 Feet With Wind Correction).

Figure 5-14 (Sheet 1 of 8)
TAKEOFF DISTANCE

CONDITIONS:

1. Takeoff Power Set - Refer To Minimum Engine Torque For Takeoff Graph Figure 5-10.
2. Wing Flaps - T.O.
3. Level, Hard Surface, Dry Runway.
4. Cowl Flaps - Open.
5. Inertial Separators - Normal.
6. Heater - As Required.

NOTE:

1. Decrease total distance 4.5 percent for each 10 knots headwind.
2. Increase total distance 25 percent for each 10 knots tailwind.
3. With inertial separator in bypass position, add 1000 feet to altitude before entering tables. (This relationship assumes that bypass is not used above 20 degrees Celsius.)

| WEIGHT- POUNDS | V _R - KIAS | SPEED AT 50-FOOT OBSTACLE- KIAS | PRESSURE ALTITUDE- FEET | 20°C | | 30°C | | 40°C | | 50°C | | |
|-------------------|--------------------------|--|-------------------------------|-------------------------|---|-------------------------|---|-------------------------|---|-------------------------|---|----|
| | | | | GROUND ROLL- FEET | TOTAL DISTANCE TO CLEAR 50-FOOT OBSTACLE- FEET | GROUND ROLL- FEET | TOTAL DISTANCE TO CLEAR 50-FOOT OBSTACLE- FEET | GROUND ROLL- FEET | TOTAL DISTANCE TO CLEAR 50-FOOT OBSTACLE- FEET | GROUND ROLL- FEET | TOTAL DISTANCE TO CLEAR 50-FOOT OBSTACLE- FEET | |
| 9360 | 98 | 102 | Sea Level | 2179 | 2701 | 2296 | 2834 | 2418 | 2971 | 2626 | 3219 | |
| | | | 1000 | 2306 | 2845 | 2432 | 2987 | 2560 | 3132 | 2866 | 3512 | |
| | | | 2000 | 2443 | 3000 | 2577 | 3152 | 2719 | 3311 | 3133 | 3842 | |
| | | | 3000 | 2588 | 3164 | 2732 | 3327 | 2959 | 3596 | -- | -- | |
| | | | 4000 | 2746 | 3343 | 2899 | 3517 | 3238 | 3935 | -- | -- | |
| | | | 5000 | 2915 | 3536 | 3116 | 3763 | 3548 | 4317 | -- | -- | |
| | | | 6000 | 3099 | 3745 | 3426 | 4140 | 3914 | 4772 | -- | -- | |
| | | | 7000 | 3332 | 4006 | 3781 | 4577 | 4339 | 5311 | -- | -- | |
| | | | 8000 | 3672 | 4422 | 4181 | 5077 | -- | -- | -- | -- | |
| | | | 9000 | 4056 | 4894 | 4634 | 5650 | -- | -- | -- | -- | |
| 10,000 | 11,000 | 12,000 | 13,000 | 14,000 | 5433 | 6313 | 5146 | 6313 | -- | -- | -- | -- |
| | | | | | 4973 | 5726 | 5726 | 7078 | -- | -- | -- | -- |
| | | | | | 5522 | 6758 | 6387 | 7986 | -- | -- | -- | -- |
| | | | | | 6149 | 7589 | -- | -- | -- | -- | -- | -- |
| | | | | | 6866 | 8570 | -- | -- | -- | -- | -- | -- |

3176
3556

Figure 5-14 (Sheet 2 of 8)
TAKEOFF DISTANCE

CONDITIONS:

1. Takeoff Power Set - Refer To Minimum Engine Torque For Takeoff Graph Figure 5-10.
2. Wing Flaps - T.O.
3. Level, Hard Surface, Dry Runway.
4. Cowl Flaps - Open.
5. Inertial Separators - Normal.
6. Heater - As Required.

NOTE:

1. Decrease total distance 4.5 percent for each 10 knots headwind.
2. Increase total distance 25 percent for each 10 knots tailwind.
3. With inertial separator in bypass position, add 1000 feet to altitude before entering tables. (This relationship assumes that bypass is not used above 20 degrees Celsius.)

| WEIGHT- POUNDS | Vr- KIAS | SPEED AT 50-FOOT OBSTACLE- KIAS | PRESSURE ALTITUDE- FEET | -20°C | | -10°C | | 0°C | | 10°C | |
|-------------------|-------------|--|-------------------------------|-------------------------|--|-------------------------|--|-------------------------|--|-------------------------|--|
| | | | | GROUND ROLL- FEET | TOTAL DISTANCE TO CLEAR 50-FOOT- OBSTACLE- FEET | GROUND ROLL- FEET | TOTAL DISTANCE TO CLEAR 50-FOOT- OBSTACLE- FEET | GROUND ROLL- FEET | TOTAL DISTANCE TO CLEAR 50-FOOT- OBSTACLE- FEET | GROUND ROLL- FEET | TOTAL DISTANCE TO CLEAR 50-FOOT- OBSTACLE- FEET |
| 8300 | 98 | 104 | Sea Level | 1569 | 1996 | 1671 | 2113 | 1773 | 2231 | 1879 | 2352 |
| | | | 1000 | 1663 | 2104 | 1770 | 2227 | 1878 | 2352 | 1988 | 2477 |
| | | | 2000 | 1763 | 2219 | 1876 | 2349 | 1990 | 2479 | 2106 | 2612 |
| | | | 3000 | 1869 | 2341 | 1986 | 2476 | 2106 | 2613 | 2230 | 2755 |
| | | | 4000 | 1981 | 2469 | 2105 | 2611 | 2233 | 2757 | 2365 | 2908 |
| | | | 5000 | 2100 | 2605 | 2232 | 2755 | 2399 | 2912 | 2508 | 3071 |
| | | | 6000 | 2227 | 2750 | 2368 | 2911 | 2514 | 3079 | 2665 | 3252 |
| | | | 7000 | 2364 | 2907 | 2515 | 3079 | 2671 | 3259 | 2833 | 3445 |
| | | | 8000 | 2512 | 3076 | 2673 | 3261 | 2843 | 3456 | 3017 | 3655 |
| | | | 9000 | 2671 | 3258 | 2847 | 3460 | 3028 | 3668 | 3264 | 3939 |
| | | | 10,000 | 2845 | 3459 | 3034 | 3674 | 3230 | 3900 | 3600 | 4350 |
| | | | 11,000 | 3033 | 3675 | 3237 | 3909 | 3524 | 4243 | 3976 | 4813 |
| | | | 12,000 | 3238 | 3909 | 3474 | 4178 | 3889 | 4688 | 4400 | 5340 |
| | | | 13,000 | 3461 | 4166 | 3825 | 4601 | 4300 | 5195 | 4879 | 5944 |
| | | | 14,000 | 3779 | 4536 | 4228 | 5091 | 4765 | 5771 | 6637 | |

Figure 5-14 (Sheet 3 of 8)
TAKEOFF DISTANCE

CONDITIONS:

1. Takeoff Power Set - Refer To Minimum Engine Torque For Takeoff Graph Figure 5-10.
2. Wing Flaps - T.O.
3. Level, Hard Surface, Dry Runway.
4. Cowl Flaps - Open.
5. Inertial Separators - Normal.
6. Heater - As Required.

NOTE:

1. Decrease total distance 4.5 percent for each 10 knots headwind.
2. Increase total distance 25 percent for each 10 knots tailwind.
3. With inertial separator in bypass position, add 1000 feet to altitude before entering tables. (This relationship assumes that bypass is not used above 20 degrees Celsius.)

| WEIGHT- POUNDS | V _R - KIAS | SPEED AT 50-FOOT OBSTACLE- KIAS | PRESSURE ALTITUDE- FEET | 20°C | | 30°C | | 40°C | | 50°C | |
|-------------------|--------------------------|--|-------------------------------|-------------------------|---|-------------------------|---|-------------------------|---|-------------------------|---|
| | | | | GROUND ROLL- FEET | TOTAL DISTANCE TO CLEAR 50-FOOT OBSTACLE- FEET | GROUND ROLL- FEET | TOTAL DISTANCE TO CLEAR 50-FOOT OBSTACLE- FEET | GROUND ROLL- FEET | TOTAL DISTANCE TO CLEAR 50-FOOT OBSTACLE- FEET | GROUND ROLL- FEET | TOTAL DISTANCE TO CLEAR 50-FOOT OBSTACLE- FEET |
| | | | | | | | | | | | |
| 8300 | 98 | 104 | Sea Level | 1984 | 2473 | 2092 | 2597 | 2201 | 2722 | 2390 | 2946 |
| | | | 1000 | 2100 | 2606 | 2214 | 2736 | 2330 | 2869 | 2608 | 3214 |
| | | | 2000 | 2224 | 2747 | 2346 | 2887 | 2474 | 3033 | 2692 | 3514 |
| | | | 3000 | 2356 | 2898 | 2486 | 3047 | 2692 | 3292 | -- | -- |
| | | | 4000 | 2499 | 3062 | 2639 | 3222 | 2946 | 3602 | -- | -- |
| | | | 5000 | 2654 | 3239 | 2835 | 3446 | 3229 | 3949 | -- | -- |
| | | | 6000 | 2820 | 3431 | 3117 | 3790 | 3562 | 4363 | -- | -- |
| | | | 7000 | 3031 | 3669 | 3440 | 4188 | 3949 | 4851 | -- | -- |
| | | | 8000 | 3341 | 4048 | 3805 | 4641 | -- | -- | -- | -- |
| | | | 9000 | 3690 | 4477 | 4216 | 5160 | -- | -- | -- | -- |
| | | | 10,000 | 4083 | 4966 | 4683 | 5757 | -- | -- | -- | |
| | | | 11,000 | 4524 | 5523 | 5211 | 6444 | -- | -- | -- | |
| | | | 12,000 | 5025 | 6161 | 5814 | 7245 | -- | -- | -- | |
| | | | 13,000 | 5594 | 6901 | -- | -- | -- | -- | -- | |
| | | | 14,000 | 6246 | 7764 | -- | -- | -- | -- | -- | |

**Figure 5-14 (Sheet 4 of 8)
TAKEOFF DISTANCE**

CONDITIONS:

1. Takeoff Power Set - Refer To Minimum Engine Torque For Takeoff Graph Figure 5-10.
2. Wing Flaps - T.O.
3. Level, Hard Surface, Dry Runway.
4. Cowl Flaps - Open.
5. Inertial Separators - Normal.
6. Heater - As Required.

NOTE:

1. Decrease total distance 4.5 percent for each 10 knots headwind.
2. Increase total distance 25 percent for each 10 knots tailwind.
3. With inertial separator in bypass position, add 1000 feet to altitude before entering tables. (This relationship assumes that bypass is not used above 20 degrees Celsius.)

| WEIGHT- POUNDS | V _R - KIAS | SPEED AT 50-FOOT OBSTACLE- KIAS | PRESSURE ALTITUDE- FEET | -20°C | | -10°C | | 0°C | | 10°C | |
|-------------------|--------------------------|--|-------------------------------|-------------------------|---|-------------------------|---|-------------------------|---|-------------------------|---|
| | | | | GROUND ROLL- FEET | TOTAL DISTANCE TO CLEAR 50-FOOT OBSTACLE- FEET | GROUND ROLL- FEET | TOTAL DISTANCE TO CLEAR 50-FOOT OBSTACLE- FEET | GROUND ROLL- FEET | TOTAL DISTANCE TO CLEAR 50-FOOT OBSTACLE- FEET | GROUND ROLL- FEET | TOTAL DISTANCE TO CLEAR 50-FOOT OBSTACLE- FEET |
| 7300 | 98 | 105 | Sea Level | 1418 | 1809 | 1510 | 1916 | 1602 | 2023 | 1697 | 2133 |
| | | | 1000 | 1503 | 1908 | 1599 | 2019 | 1697 | 2133 | 1795 | 2246 |
| | | | 2000 | 1592 | 2011 | 1695 | 2130 | 1797 | 2248 | 1902 | 2368 |
| | | | 3000 | 1689 | 2123 | 1794 | 2244 | 1903 | 2370 | 2014 | 2498 |
| | | | 4000 | 1789 | 2238 | 1901 | 2368 | 2016 | 2500 | 2135 | 2637 |
| | | | 5000 | 1896 | 2362 | 2015 | 2499 | 2138 | 2642 | 2264 | 2786 |
| | | | 6000 | 2011 | 2494 | 2138 | 2639 | 2270 | 2792 | 2406 | 2949 |
| | | | 7000 | 2134 | 2636 | 2270 | 2792 | 2411 | 2955 | 2557 | 3124 |
| | | | 8000 | 2267 | 2789 | 2413 | 2957 | 2566 | 3134 | 2723 | 3315 |
| | | | 9000 | 2411 | 2956 | 2569 | 3138 | 2733 | 3327 | 3571 | |
| | | | 10000 | 2568 | 3137 | 2738 | 3332 | 2915 | 3537 | 3248 | 3942 |
| | | | 11000 | 2738 | 3332 | 2922 | 3544 | 3179 | 3845 | 3588 | 4360 |
| | | | 12000 | 2921 | 3544 | 3134 | 3786 | 3508 | 4247 | 3970 | 4834 |
| | | | 13000 | 3124 | 3777 | 3451 | 4167 | 3879 | 4702 | 4403 | 5374 |
| | | | 14000 | 3408 | 4111 | 3813 | 4611 | 4298 | 5222 | 4893 | |

Figure 5-14 (Sheet 5 of 8)
TAKEOFF DISTANCE

CONDITIONS:

1. Takeoff Power Set - Refer To Minimum Engine Torque For Takeoff Graph Figure 5-10.
2. Wing Flaps - T.O.
3. Level, Hard Surface, Dry Runway.
4. Cowl Flaps - Open.
5. Inertial Separators - Normal.
6. Heater - As Required.

NOTE:

1. Decrease total distance 4.5 percent for each 10 knots headwind.
2. Increase total distance 25 percent for each 10 knots tailwind.
3. With inertial separator in bypass position, add 1000 feet to altitude before entering tables. (This relationship assumes that bypass is not used above 20 degrees Celsius.)

| WEIGHT - POUNDS | V _R - KIAS | SPEED AT 50-FOOT OBSTACLE - KIAS | PRESSURE ALTITUDE - FEET | 20°C | | 30°C | | 40°C | | 50°C | |
|-----------------|-----------------------|----------------------------------|--------------------------|--------------------|---|--------------------|---|--------------------|---|--------------------|---|
| | | | | GROUND ROLL - FEET | TOTAL DISTANCE TO CLEAR 50-FOOT OBSTACLE - FEET | GROUND ROLL - FEET | TOTAL DISTANCE TO CLEAR 50-FOOT OBSTACLE - FEET | GROUND ROLL - FEET | TOTAL DISTANCE TO CLEAR 50-FOOT OBSTACLE - FEET | GROUND ROLL - FEET | TOTAL DISTANCE TO CLEAR 50-FOOT OBSTACLE - FEET |
| | | | | | | | | | | | |
| 7300 | 98 | 105 | Sea Level | 1793 | 2243 | 1889 | 2354 | 1988 | 2468 | 2157 | 2670 |
| | | | 1000 | 1897 | 2363 | 2000 | 2481 | 2104 | 2602 | 2355 | 2913 |
| | | | 2000 | 2008 | 2491 | 2118 | 2293 | 2750 | 2574 | 2913 | 3184 |
| | | | 3000 | 2127 | 2628 | 2245 | 2763 | 2984 | -- | -- | -- |
| | | | 4000 | 2256 | 2777 | 2382 | 2922 | 2659 | 3264 | -- | -- |
| | | | 5000 | 2396 | 2939 | 2558 | 3125 | 2914 | 3579 | -- | -- |
| | | | 6000 | 2546 | 3111 | 2813 | 3434 | 3215 | 3950 | -- | -- |
| | | | 7000 | 2735 | 3326 | 3104 | 3794 | 3564 | 4390 | -- | -- |
| | | | 8000 | 3014 | 3668 | 3433 | 4203 | -- | -- | -- | -- |
| | | | 9000 | 3329 | 4057 | 3805 | 4671 | -- | -- | -- | -- |
| | | | 10,000 | 3684 | 4497 | 4227 | 5205 | -- | -- | -- | -- |
| | | | 11,000 | 4083 | 4997 | 4704 | 5819 | -- | -- | -- | -- |
| 12,000 | 4534 | 5568 | 5247 | 6528 | -- | -- | -- | -- | | | |
| 13,000 | 5048 | 6226 | -- | -- | -- | -- | -- | -- | | | |
| 14,000 | 5635 | 6993 | -- | -- | -- | -- | -- | -- | | | |

**Figure 5-14 (Sheet 6 of 8)
TAKEOFF DISTANCE**

CONDITIONS:

1. Takeoff Power Set - Refer To Minimum Engine Torque For Takeoff Graph Figure 5-10.
2. Wing Flaps - T.O.
3. Level, Hard Surface, Dry Runway.
4. Cowl Flaps - Open.
5. Inertial Separators - Normal.
6. Heater - As Required.

NOTE:

1. Decrease total distance 4.5 percent for each 10 knots headwind.
2. Increase total distance 25 percent for each 10 knots tailwind.
3. With inertial separator in bypass position, add 1000 feet to altitude before entering tables. (This relationship assumes that bypass is not used above 20 degrees Celsius.)

| WEIGHT- POUNDS | V _R - KIAS | SPEED AT 50-FOOT OBSTACLE- KIAS | PRESSURE ALTITUDE- FEET | -20°C | | -10°C | | 0°C | | 10°C | | |
|-------------------|--------------------------|--|-------------------------------|-------------------------|--|-------------------------|--|-------------------------|--|-------------------------|--|------|
| | | | | GROUND ROLL- FEET | TOTAL DISTANCE TO CLEAR 50-FOOT- OBSTACLE- FEET | GROUND ROLL- FEET | TOTAL DISTANCE TO CLEAR 50-FOOT- OBSTACLE- FEET | GROUND ROLL- FEET | TOTAL DISTANCE TO CLEAR 50-FOOT- OBSTACLE- FEET | GROUND ROLL- FEET | TOTAL DISTANCE TO CLEAR 50-FOOT- OBSTACLE- FEET | |
| 6300 | 98 | 107 | Sea Level | 1252 | 1611 | 1333 | 1705 | 1415 | 1802 | 1498 | 1899 | |
| | | | 1000 | 1327 | 1699 | 1412 | 1798 | 1499 | 1899 | 1585 | 2001 | |
| | | | 2000 | 1406 | 1791 | 1496 | 1896 | 1587 | 2002 | 1678 | 2109 | |
| | | | 3000 | 1491 | 1890 | 1585 | 1999 | 1680 | 2111 | 1778 | 2225 | |
| | | | | 4000 | 1580 | 1994 | 1678 | 2109 | 1779 | 1884 | 2349 | |
| | 5000 | | | 5000 | 1674 | 2103 | 1778 | 2225 | 1887 | 2352 | 1998 | 2481 |
| | | | | 6000 | 1774 | 2221 | 1886 | 2351 | 2002 | 2488 | 2122 | 2627 |
| | | | | 7000 | 1884 | 2348 | 2003 | 2487 | 2128 | 2633 | 2256 | 2783 |
| | | | | 8000 | 2001 | 2484 | 2129 | 2634 | 2292 | 2953 | 2402 | 3179 |
| | | | | 9000 | 2127 | 2632 | 2266 | 2795 | 2411 | 2994 | 2596 | 3179 |
| | | | | 10000 | 2265 | 2794 | 2415 | 2969 | 2571 | 3151 | 2863 | 3510 |
| | | | | 11000 | 2414 | 2968 | 2576 | 3157 | 2801 | 3423 | 3162 | 3880 |
| 12000 | | | | 2577 | 3158 | 2763 | 3373 | 3092 | 3779 | 3498 | 4299 | |
| 13000 | | | 13000 | 2754 | 3364 | 3040 | 3709 | 3417 | 4184 | 3878 | 4778 | |
| | | | 14000 | 3003 | 3659 | 3360 | 4102 | 3786 | 4643 | 4311 | 5327 | |

Figure 5-14 (Sheet 7 of 8)
TAKEOFF DISTANCE

CONDITIONS:

1. Takeoff Power Set - Refer To Minimum Engine Torque For Takeoff Graph Figure 5-10.
2. Wing Flaps - 1.0.
3. Level, Hard Surface, Dry Runway.
4. Cowl Flaps - Open.
5. Inertial Separators - Normal.
6. Heater - As Required.

NOTE:

1. Decrease total distance 4.5 percent for each 10 knots headwind.
2. Increase total distance 25 percent for each 10 knots tailwind.
3. With inertial separator in bypass position, add 1000 feet to altitude before entering tables. (This relationship assumes that bypass is not used above 20 degrees Celsius.)

| WEIGHT- POUNDS | V _R - KIAS | SPEED AT 50-FOOT OBSTACLE- KIAS | PRESSURE ALTITUDE- FEET | 20°C | | 30°C | | 40°C | | 50°C | |
|-------------------|--------------------------|--|-------------------------------|-------------------------|---|-------------------------|---|-------------------------|---|-------------------------|---|
| | | | | GROUND ROLL- FEET | TOTAL DISTANCE TO CLEAR 50-FOOT OBSTACLE- FEET | GROUND ROLL- FEET | TOTAL DISTANCE TO CLEAR 50-FOOT OBSTACLE- FEET | GROUND ROLL- FEET | TOTAL DISTANCE TO CLEAR 50-FOOT OBSTACLE- FEET | GROUND ROLL- FEET | TOTAL DISTANCE TO CLEAR 50-FOOT OBSTACLE- FEET |
| 6300 | 98 | 107 | Sea Level | 1997 | 2096 | 1667 | 2256 | 1755 | 2198 | 1903 | 2377 |
| | | | 1000 | 2104 | 2210 | 1765 | 2480 | 1857 | 2317 | 2077 | 2593 |
| | | | 2000 | 2219 | 2331 | 1869 | 3059 | 1970 | 2449 | 2271 | 2834 |
| | | | 3000 | 2341 | 2462 | 1981 | 3378 | 2144 | 2657 | -- | -- |
| | | | 4000 | 2474 | 2604 | 2102 | 3741 | 2345 | 2906 | -- | -- |
| | | | 5000 | 2617 | 2782 | 2256 | 4155 | 2570 | 3186 | -- | -- |
| | | | 6000 | 2772 | 2962 | 2480 | 4629 | 2835 | 3516 | -- | -- |
| | | | 7000 | 2962 | 3266 | 2738 | 5168 | 3143 | 3905 | -- | -- |
| | | | 8000 | 3266 | 3611 | 3027 | 5791 | -- | -- | -- | -- |
| | | | 9000 | 3611 | 3611 | 3355 | -- | -- | -- | -- | -- |
| | | | 10,000 | 4002 | 4002 | 3726 | -- | -- | -- | -- | -- |
| | | | 11,000 | 4444 | 4145 | 4145 | -- | -- | -- | -- | -- |
| 12,000 | 4948 | 4622 | 4622 | -- | -- | -- | -- | -- | | | |
| 13,000 | 5528 | -- | -- | -- | -- | -- | -- | -- | | | |
| 14,000 | 6201 | -- | -- | -- | -- | -- | -- | -- | | | |

Figure 5-14 (Sheet 8 of 8)
TAKEOFF DISTANCE

CONDITIONS:

1. Takeoff Power Set - Refer To Minimum Torque For Takeoff Graph Figure 5-10.
2. Wing Flaps - T.O.
3. Level, Hard Surface, Dry Runway
4. Cowl Flaps - Open.
5. Inertial Separator - Normal.
6. Heater - As Required.
7. Autofeather - Armed.

NOTE:

1. Engine is assumed to fail just prior to V_R .
2. If full power is applied without brakes set, distance apply from point where full power is achieved.
3. Decrease total distance 5 percent for each 10 knots headwind.
4. Increase total distance 25 percent for each 10 knots tailwind.
5. With inertial separator in bypass position add 1000 feet to altitude before entering tables. (This relationship assumes that bypass is not used above 20 degrees Celsius.)

| PRESSURE ALTITUDE - FEET | WEIGHT - POUNDS | V_R - KIAS | V_2 - KIAS | TOTAL DISTANCE TO CLEAR 50-FOOT OBSTACLE - FEET | | | | | | | |
|--|-----------------|--------------|--------------|---|-------|------|------|------|------|------|------|
| | | | | -20°C | -10°C | 0°C | 10°C | 20°C | 30°C | 40°C | 50°C |
| Sea Level 1000 2000 3000 4000 | 9360 | 98 | 102 | 2908 | 3151 | 3415 | 3704 | 4025 | 4379 | 4827 | -- |
| | | | | 3132 | 3406 | 3704 | 4038 | 4424 | 4893 | 5483 | -- |
| | | | | 3388 | 3698 | 4043 | 4445 | 4921 | 5578 | 7608 | -- |
| | | | | 3678 | 4034 | 4446 | 4968 | 5652 | 6654 | -- | -- |
| | | | | 4013 | 4439 | 4981 | 5697 | 6793 | 8914 | -- | -- |
| | | | | 4419 | 4961 | 5726 | 6887 | 9263 | -- | -- | -- |
| | | | | 4953 | 5724 | 6942 | 9446 | -- | -- | -- | -- |
| | | | | 5698 | 6924 | 9748 | -- | -- | -- | -- | -- |
| | | | | 6925 | 9805 | -- | -- | -- | -- | -- | -- |
| | | | | 9813 | -- | -- | -- | -- | -- | -- | -- |
| 5000 6000 7000 8000 9000 | 9360 | 98 | 102 | -- | -- | -- | -- | -- | -- | -- | -- |
| | | | | -- | -- | -- | -- | -- | -- | -- | -- |
| | | | | -- | -- | -- | -- | -- | -- | -- | -- |
| | | | | -- | -- | -- | -- | -- | -- | -- | -- |
| | | | | -- | -- | -- | -- | -- | -- | -- | -- |
| 10,000 11,000 12,000 13,000 14,000 | 9360 | 98 | 102 | -- | -- | -- | -- | -- | -- | -- | -- |
| | | | | -- | -- | -- | -- | -- | -- | -- | -- |
| | | | | -- | -- | -- | -- | -- | -- | -- | -- |
| | | | | -- | -- | -- | -- | -- | -- | -- | -- |
| | | | | -- | -- | -- | -- | -- | -- | -- | -- |
| Sea Level 1000 2000 3000 4000 | 8300 | 98 | 102 | 2276 | 2434 | 2579 | 2766 | 2942 | 3121 | 3319 | 4090 |
| | | | | 2422 | 2591 | 2766 | 2949 | 3140 | 3345 | 3563 | 5152 |
| | | | | 2581 | 2762 | 2951 | 3150 | 3359 | 3594 | 4014 | 8389 |
| | | | | 2751 | 2946 | 3151 | 3375 | 3616 | 3880 | 4912 | -- |
| | | | | 2935 | 3147 | 3380 | 3629 | 3908 | 4234 | 7007 | -- |
| | | | | 3138 | 3374 | 3638 | 3928 | 4256 | 5161 | -- | -- |
| | | | | 3368 | 3637 | 3939 | 4275 | 4682 | 7853 | -- | -- |
| | | | | 3628 | 3936 | 4297 | 4715 | 5850 | -- | -- | -- |
| | | | | 3934 | 4302 | 4744 | 5291 | -- | -- | -- | -- |
| | | | | 4300 | 4753 | 5318 | 7423 | -- | -- | -- | -- |
| 5000 6000 7000 8000 9000 | 8300 | 98 | 102 | 4749 | 5326 | 6160 | -- | -- | -- | -- | -- |
| | | | | 5333 | 6163 | -- | -- | -- | -- | -- | -- |
| | | | | 6168 | 8765 | -- | -- | -- | -- | -- | -- |
| | | | | 7583 | -- | -- | -- | -- | -- | -- | -- |
| | | | | -- | -- | -- | -- | -- | -- | -- | -- |
| 10,000 11,000 12,000 13,000 14,000 | 8300 | 98 | 102 | -- | -- | -- | -- | -- | -- | -- | -- |
| | | | | -- | -- | -- | -- | -- | -- | -- | -- |
| | | | | -- | -- | -- | -- | -- | -- | -- | -- |
| | | | | -- | -- | -- | -- | -- | -- | -- | -- |
| | | | | -- | -- | -- | -- | -- | -- | -- | -- |

EXAMPLE:

Weight - 9000 Pounds.
Outside Air Temperature - 16 Degrees Celsius.
Pressure Altitude - 2400 Feet.
Headwind Component - 19 Knots.

Distance To Accelerate Go (Approximation Method) - 5652 Feet (5115 Feet With Wind Correction).

**Figure 5-15 (Sheet 1 of 2)
ACCELERATE GO DISTANCE**

MODEL 406

CONDITIONS:

1. Takeoff Power Set - Refer To Minimum Torque For Takeoff Graph Figure 5-10.
2. Wing Flaps - T.O.
3. Level, Hard Surface, Dry Runway
4. Cowl Flaps - Open.
5. Inertial Separator - Normal.
6. Heater - As Required.
7. Autofeather - Armed.

NOTE:

1. Engine is assumed to fail just prior to V_R .
2. If full power is applied without brakes set, distance apply from point where full power is achieved.
3. Decrease total distance 5 percent for each 10 knots headwind.
4. Increase total distance 25 percent for each 10 knots tailwind.
5. With inertial separator in bypass position add 1000 feet to altitude before entering tables. (This relationship assumes that bypass is not used above 20 degrees Celsius.)

| PRESSURE ALTITUDE - FEET | WEIGHT - POUNDS | V_R - KIAS | V_2 - KIAS | TOTAL DISTANCE TO CLEAR 50-FOOT OBSTACLE - FEET | | | | | | | |
|--|-----------------|--------------|--------------|---|-------|------|------|------|------|------|------|
| | | | | -20°C | -10°C | 0°C | 10°C | 20°C | 30°C | 40°C | 50°C |
| Sea Level 1000 2000 3000 4000 | 7300 | 98 | 102 | 1871 | 1992 | 2116 | 2242 | 2372 | 2503 | 2643 | 3085 |
| | | | | 1982 | 2111 | 2243 | 2377 | 2515 | 2660 | 2811 | 3544 |
| | | | | 2103 | 2239 | 2379 | 2523 | 2671 | 2831 | 3092 | 4208 |
| | | | | 2231 | 2375 | 2524 | 2681 | 2845 | 3019 | 3530 | -- |
| | | | | 2367 | 2521 | 2685 | 2855 | 3037 | 3242 | 4138 | -- |
| 5000 6000 7000 8000 9000 | | | | 2514 | 2681 | 2861 | 3049 | 3251 | 3687 | 5134 | -- |
| | | | | 2677 | 2860 | 3056 | 3264 | 3495 | 4376 | 8071 | -- |
| | | | | 2854 | 3055 | 3276 | 3512 | 3988 | 5673 | -- | -- |
| | | | | 3053 | 3279 | 3527 | 3804 | 4855 | -- | -- | -- |
| | | | | 3277 | 3532 | 3813 | 4435 | 6716 | -- | -- | -- |
| 10,000 11,000 12,000 13,000 14,000 | | | | 3530 | 3818 | 4169 | 5606 | -- | -- | -- | -- |
| | | | | 3819 | 4157 | 5034 | 9351 | -- | -- | -- | -- |
| | | | | 4159 | 4746 | 6872 | -- | -- | -- | -- | -- |
| | | | | 4579 | 6097 | -- | -- | -- | -- | -- | -- |
| | | | | 5711 | -- | -- | -- | -- | -- | -- | -- |
| Sea Level 1000 2000 3000 4000 | 6300 | 98 | 102 | 1542 | 1638 | 1737 | 1837 | 1938 | 2041 | 2149 | 2461 |
| | | | | 1631 | 1733 | 1837 | 1942 | 2050 | 2162 | 2278 | 2761 |
| | | | | 1727 | 1834 | 1944 | 2056 | 2171 | 2293 | 2485 | 3140 |
| | | | | 1828 | 1941 | 2057 | 2178 | 2304 | 2435 | 2781 | -- |
| | | | | 1935 | 2055 | 2181 | 2311 | 2448 | 2602 | 3149 | -- |
| 5000 6000 7000 8000 9000 | | | | 2049 | 2178 | 2315 | 2457 | 2607 | 2903 | 3632 | -- |
| | | | | 2175 | 2315 | 2463 | 2616 | 2784 | 3314 | 4384 | -- |
| | | | | 2310 | 2462 | 2626 | 2796 | 3111 | 3894 | 5988 | -- |
| | | | | 2460 | 2628 | 2807 | 3003 | 3590 | 4813 | -- | -- |
| | | | | 2626 | 2810 | 3008 | 3394 | 4268 | 6984 | -- | -- |
| 10,000 11,000 12,000 13,000 14,000 | | | | 2809 | 3012 | 3252 | 3956 | 5436 | -- | -- | -- |
| | | | | 3012 | 3241 | 3734 | 4792 | 9242 | -- | -- | -- |
| | | | | 3242 | 3600 | 4417 | 6478 | -- | -- | -- | -- |
| | | | | 3515 | 4207 | 5555 | -- | -- | -- | -- | -- |
| | | | | 4075 | 5127 | 8843 | -- | -- | -- | -- | -- |

Figure 5-15 (Sheet 2 of 2)
ACCELERATE GO DISTANCE

SPEED - 102 KIAS

CONDITIONS:

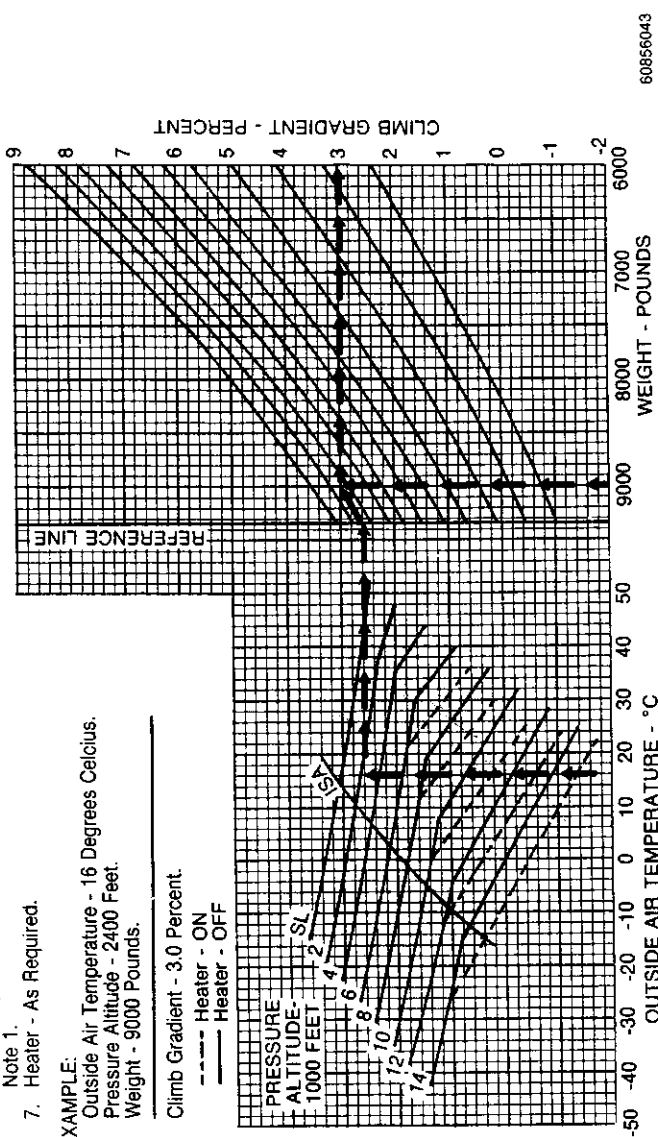
1. Takeoff Power Set - Refer To Minimum Engine Torque For Takeoff Graph Figure 5-10.
2. Inoperative Engine - Propeller Feathered.
3. Wing Flaps - T.O.
4. Landing Gear - Up.
5. Cowl Flap - Open.
6. Inertial Separators - Refer To Note 1.
7. Heater - As Required.

EXAMPLE:

Outside Air Temperature - 16 Degrees Celsius.
Pressure Altitude - 2400 Feet.
Weight - 9000 Pounds.

Climb Gradient - 3.0 Percent.

----- Heater - ON
———— Heater - OFF



60856043

**Figure 5-16
TAKEOFF CLIMB GRADIENT AT V₂ - ONE
ENGINE INOPERATIVE**

SPEED - 109 KIAS

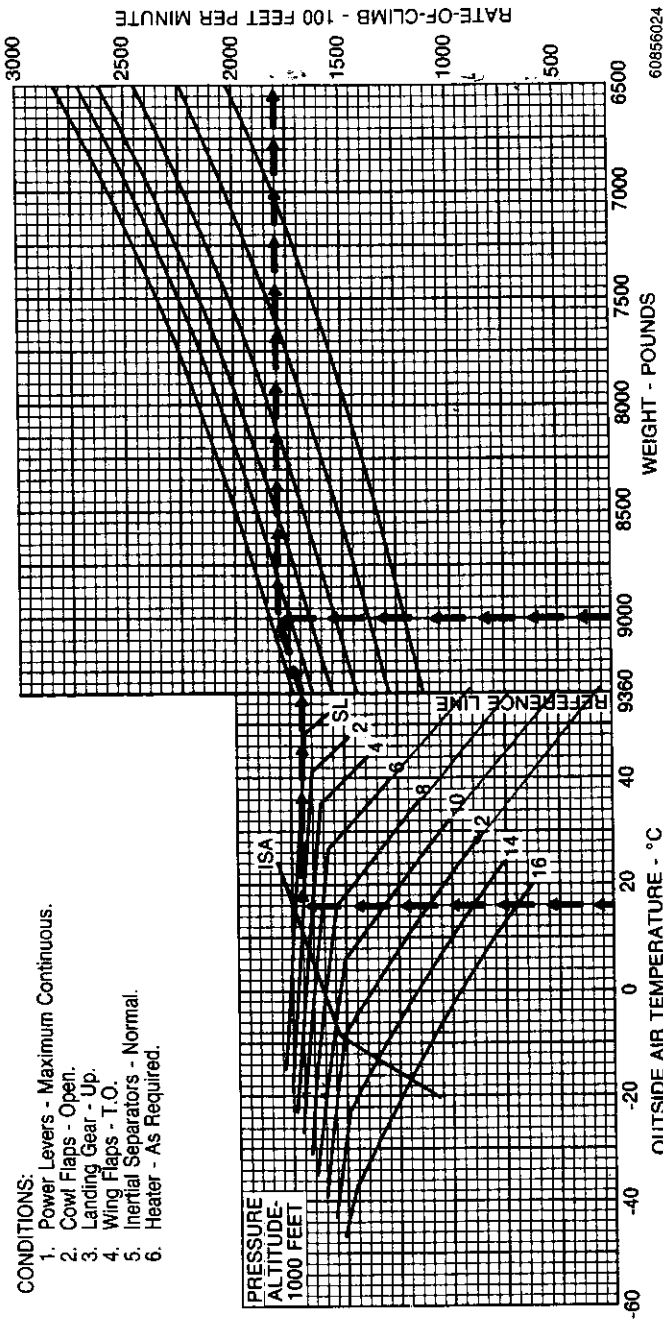
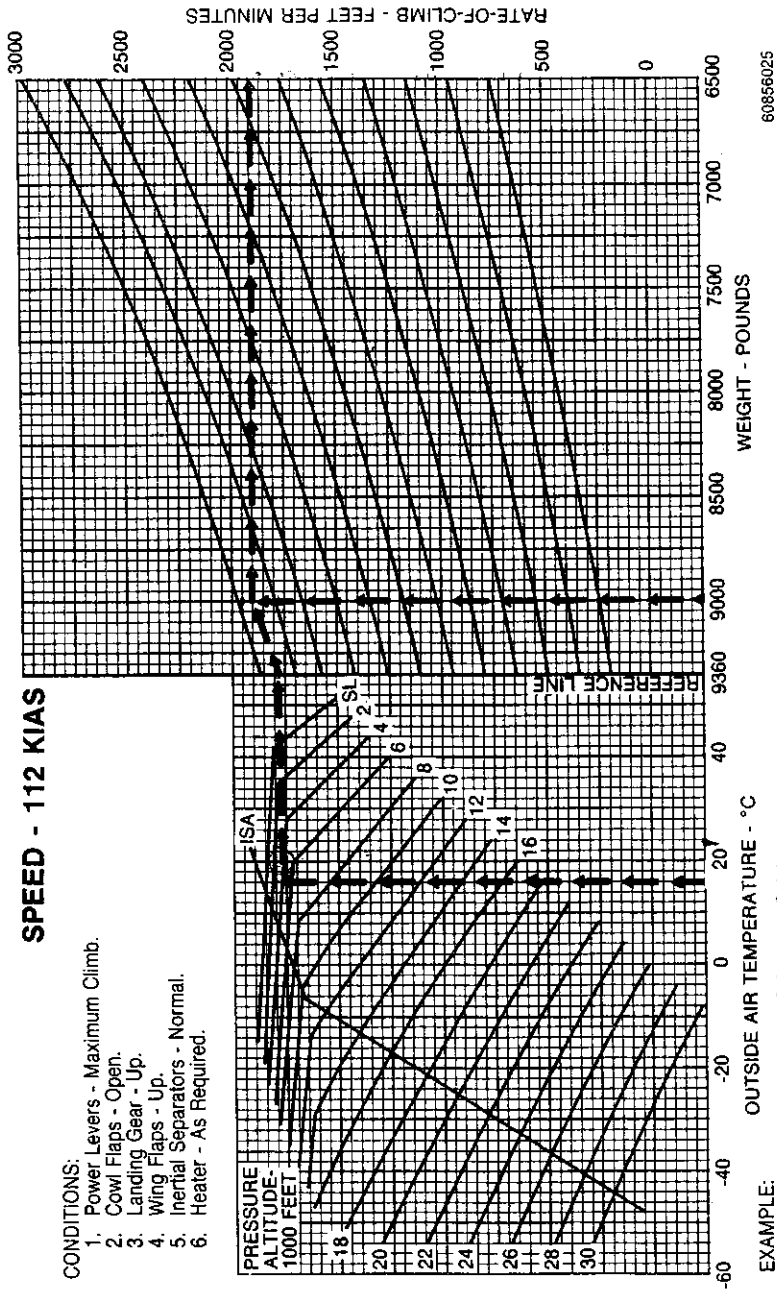


Figure 5-17

RATE-OF-CLIMB - ALL ENGINES OPERATING (FLAPS-T.O.)



60856025

SPEED - 112 KIAS

CONDITIONS:

1. Power Levers - Maximum Climb.
2. Cowl Flaps - Open.
3. Landing Gear - Up.
4. Wing Flaps - Up.
5. Inertial Separators - Normal.
6. Heater - As Required.

EXAMPLE:

Outside Air Temperature - 16 Degrees Celsius.
Pressure Altitude - 2400 Feet.
Weight - 9000 Pounds.

Rate-of-Climb - 1900 Feet Per Minute.
Climb Speed - 112 KIAS.

Figure 5-18
RATE-OF-CLIMB - ALL ENGINES OPERATING
(FLAPS - UP) (MAXIMUM CLIMB)

CONDITIONS:

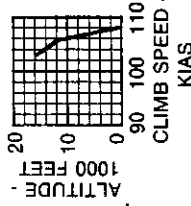
1. Inoperative Engine
 - a. Propeller - Feathered.
 - b. Cowl Flap - Closed.
2. Operating Engine
 - a. Power - Torque or ITT Limit at 1900 RPM.
 - b. Cowl Flap - Open.
3. Landing Gear - Up.
4. Wing Flaps - Up.
5. Inertial Separators - Normal.
6. Heater - As Required.

SPEED - 108 KIAS

NOTES:

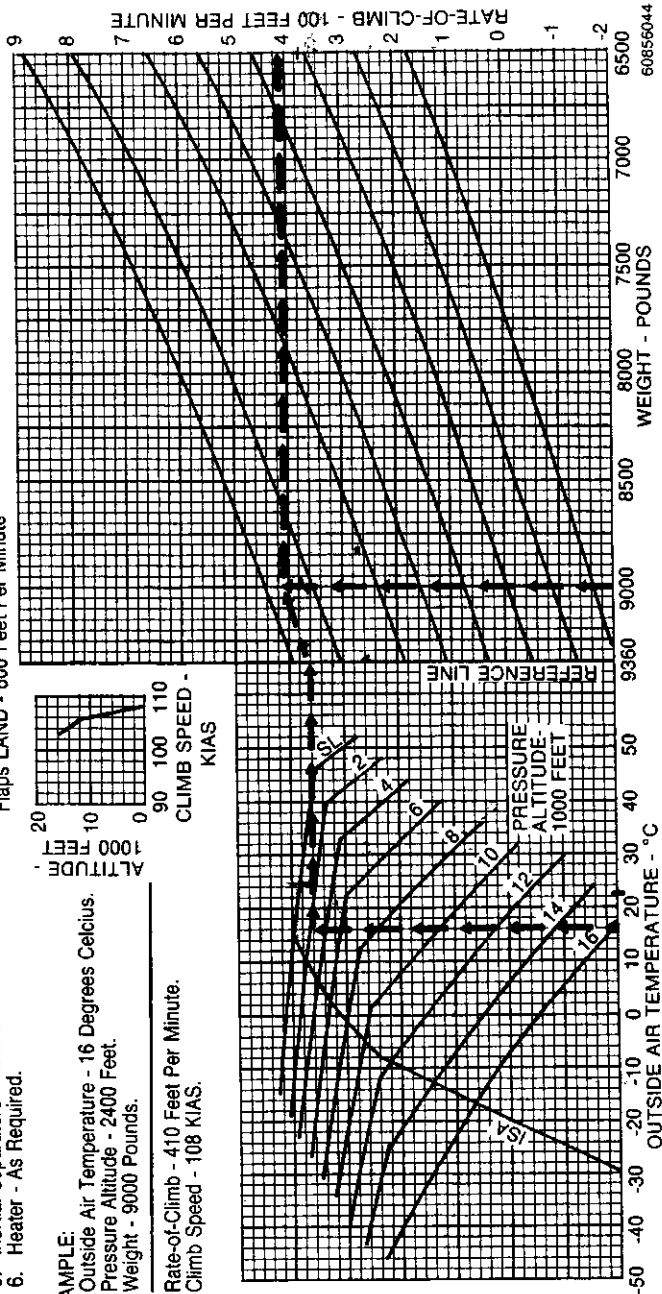
1. The optimum bank angle for one-engine inoperative climb performance is 3° to 4° bank with approximately 1/2 ball slip into operative engine.
2. Approximate effect of configuration on one inoperative engine rate-of-climb.
3. Subtract values listed below from value obtained from graph. Effects for a combination of gear or flaps may be obtained by adding the effects for each.

- Gear DOWN - 300 Feet Per Minute
- Flaps T.O. - 200 Feet Per Minute
- Flaps APPR - 600 Feet Per Minute
- Flaps LAND - 800 Feet Per Minute



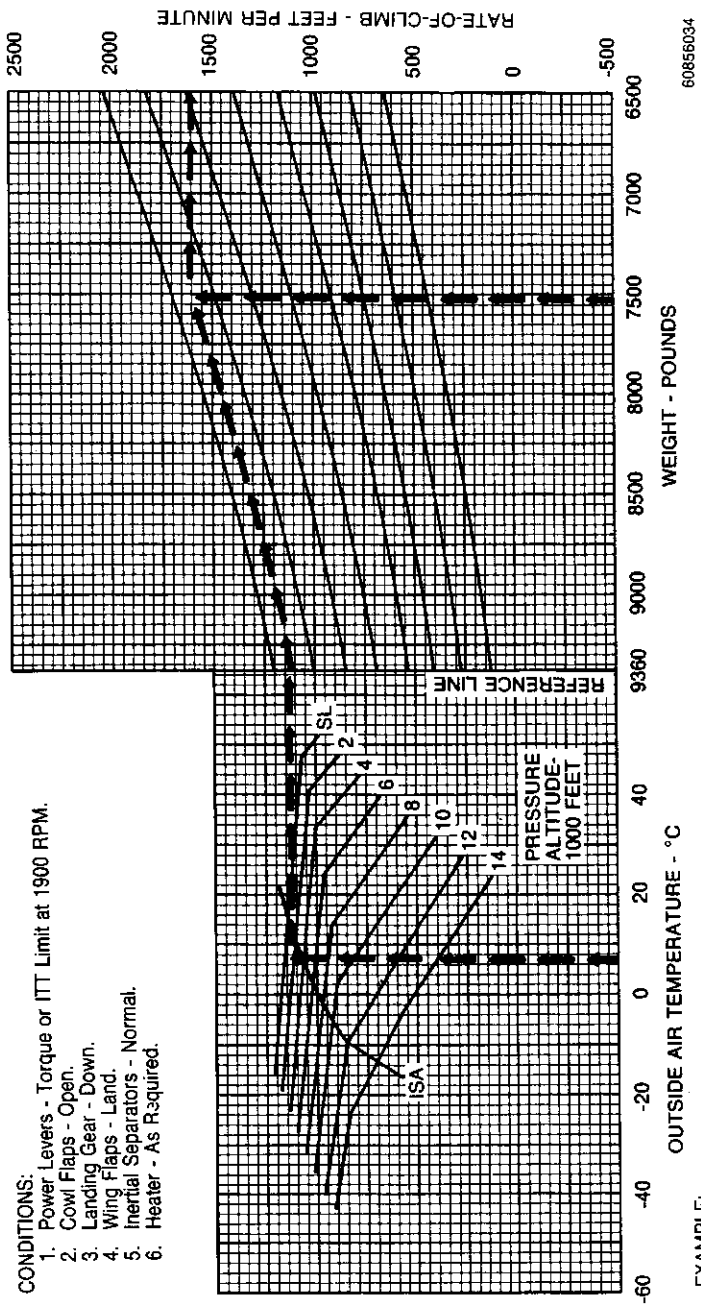
EXAMPLE:
 Outside Air Temperature - 16 Degrees Celsius.
 Pressure Altitude - 2400 Feet.
 Weight - 9000 Pounds.

Rate-of-Climb - 410 Feet Per Minute.
 Climb Speed - 108 KIAS.



**Figure 5-19
RATE-OF-CLIMB - ONE ENGINE INOPERATIVE**

SPEED - 101 KIAS



CONDITIONS:

1. Power Levers - Torque or ITT Limit at 1900 RPM.
2. Cowl Flaps - Open.
3. Landing Gear - Down.
4. Wing Flaps - Land.
5. Inertial Separators - Normal.
6. Heater - As Required.

EXAMPLE:

Outside Air Temperature - 7 Degrees Celsius.
 Pressure Altitude - 1700 Feet.
 Weight - 7524 Pounds.

Rate-of-Climb - 1600 Feet Per Minute.
 Climb Speed - 101 KIAS.

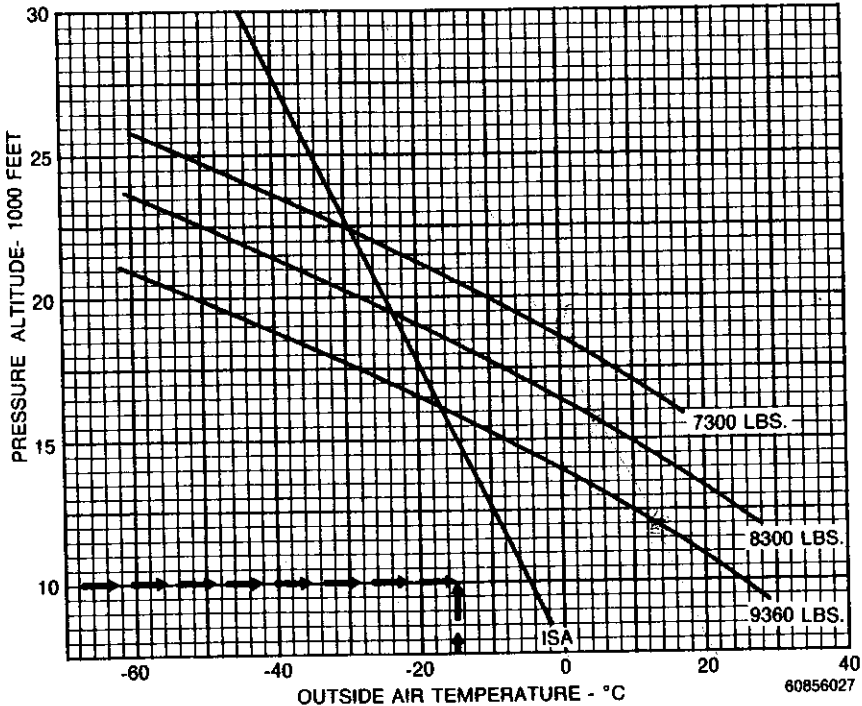
Figure 5-20
RATE-OF-CLIMB - BALKED LANDING CLIMB

CONDITIONS:

1. Engine Inoperative Climb Configuration.
2. Climb Speed - As Scheduled.
3. Inertial Separators - Normal.
4. Heater - As Required.

NOTES:

1. One engine inoperative service ceiling is the maximum altitude where the airplane has the capability of climbing 50 feet per minute with one engine inoperative and propeller feathered.
2. Inertial separator in Bypass Mode - Subtract 2000 feet from one engine inoperative service ceiling.
3. Increase indicated service ceiling 100 feet for each 0.10 inch Hg. altimeter setting greater than 29.92.
4. Decrease indicated service ceiling 100 feet for each 0.10 inch Hg. altimeter setting less than 29.92.



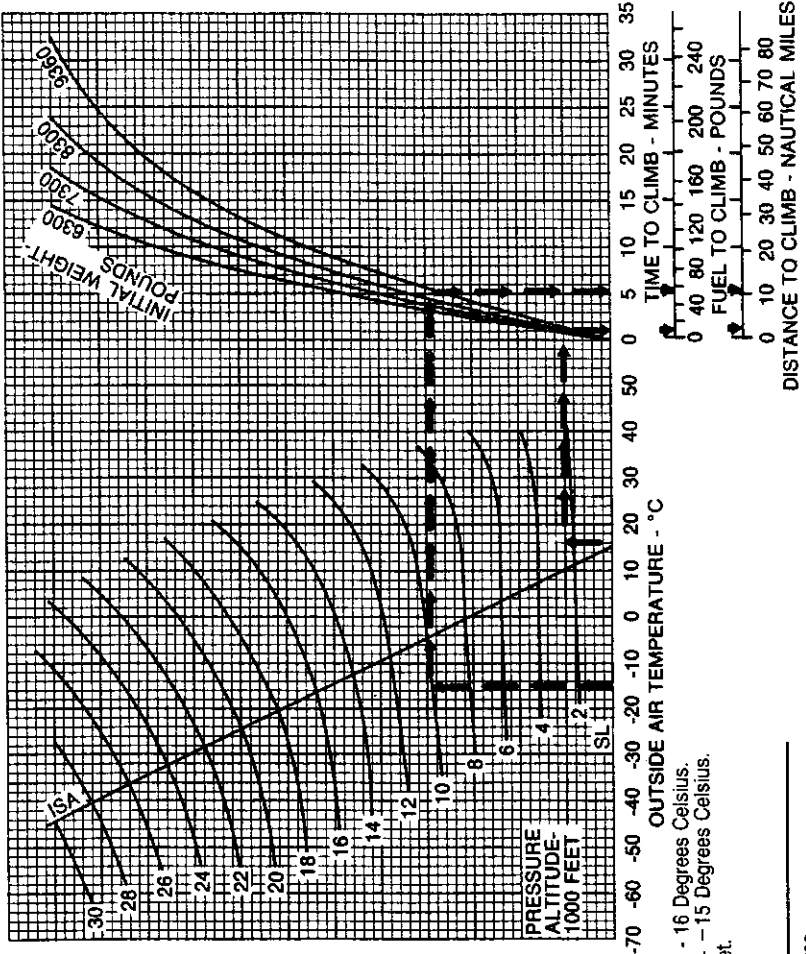
EXAMPLE:

Outside Air Temperature At Enroute Altitude - -15 Degrees Celsius.
Enroute Altitude - 10,000 Feet.

Weight - Above 9360 Pounds.

**Figure 5-21
SERVICE CEILING - ONE ENGINE INOPERATIVE**

SPEED 112 KIAS



60656028

- CONDITIONS:**
1. Power Levers - Maximum Climb.
 2. Cowl Flaps - Open.
 3. Landing Gear - Up.
 4. Wing Flaps - Up.
 5. Inertial Separators - Normal.
 6. Heater - As Required.

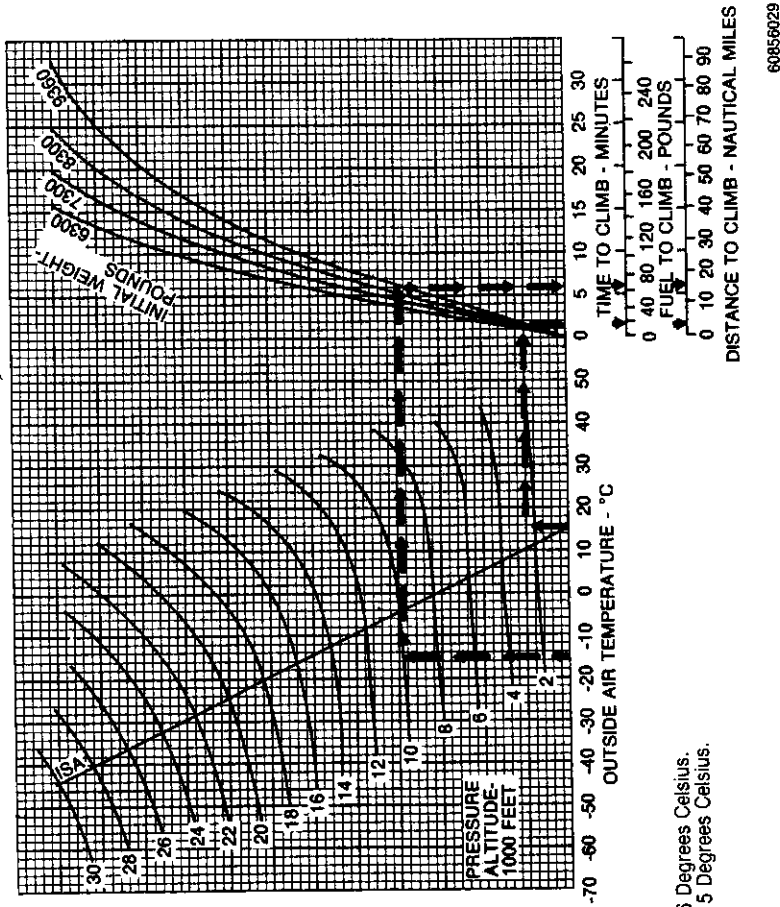
- NOTES:**
1. Time, fuel and distance for climb are determined by taking the difference between the airport altitude and initial cruise altitude conditions.
 2. For total fuel used, add 75 pounds for start, taxi and runup.

EXAMPLE:

Outside Air Temperature At Takeoff - 16 Degrees Celsius.
 Outside Air Temperature At Cruise - -15 Degrees Celsius.
 Airport Pressure Altitude - 2400 Feet.
 Cruise Altitude - 10,000 Feet.
 Initial Climb Weight - 9,000 Pounds.

Time to Climb (5.2 - 1.2) - 4.0 Minutes.
 Fuel to Climb (59 - 13) - 46 Pounds.
 Distance to Climb (11 - 2.5) - 8.5 Nautical Miles.

Figure 5-22
TIME, FUEL AND DISTANCE TO CLIMB - MAXIMUM CLIMB



60856029

CONDITIONS:

1. Power Levers - Maximum Cruise.
2. Cowl Flaps - As Required.
3. Landing Gear - Up.
4. Wing Flaps - Up.
5. Inertial Separators - Normal.
6. Heater - As Required.

NOTES:

1. Time, fuel and distance for climb are determined by taking the difference between the airport altitude and initial cruise altitude conditions.
2. For total fuel used, add 75 pounds for start, taxi and runup.

| PRESSURE ALTITUDE- FEET | CLIMB SPEED KIAS |
|-------------------------|------------------|
| SL to 12,000 | 140 |
| 12,000 to 20,000 | 125 |
| 20,000 to 30,000 | 110 |

EXAMPLE:

Outside Air Temperature At Takeoff - 16 Degrees Celsius.
 Outside Air Temperature At Cruise - -15 Degrees Celsius.
 Airport Pressure Altitude - 2400 Feet.
 Cruise Altitude - 10,000 Feet.
 Initial Climb Weight - 9000 Pounds.

Time to Climb (5.9 - 1.4) - 4.5 Minutes.
 Fuel to Climb (67 - 20) - 47 Pounds.
 Distance to Climb (15 - 3) - 12 Nautical Miles.

**Figure 5-23
TIME, FUEL AND DISTANCE TO CLIMB - CRUISE CLIMB**

CONDITIONS:

1. Power Levers - Set.
2. Propeller Control Levers - 1900 RPM
3. Landing Gear - Up.
4. Wing Flaps - Up.
5. Cowl Flaps - As required.
6. Inertial Separators - Normal.
7. Heater - As required.

NOTE:

1. Do not exceed Maximum Cruise Power Table values or 695 degrees Celsius ITT, whichever occurs first.

| | PRESSURE ALTITUDE - FEET | OAT °C | IOAT °C | TORQUE - FT-LBS | FUEL FLOW PER ENGINE - LB/HR | TOTAL FUEL FLOW - LB/HR | 7300 POUNDS | | 8300 POUNDS | | 9360 POUNDS | |
|--------------|--------------------------|--------|---------|-----------------|------------------------------|-------------------------|-------------|------|-------------|------|-------------|------|
| | | | | | | | KIAS | KTAS | KIAS | KTAS | KIAS | KTAS |
| ISA -30°C | Sea Level | -15 | -11 | 1382 | 331 | 662 | 219 | 208 | 218 | 207 | 217 | 206 |
| | 2000 | -19 | -14 | 1382 | 323 | 645 | 217 | 212 | 216 | 211 | 215 | 210 |
| | 4000 | -23 | -18 | 1382 | 315 | 619 | 215 | 216 | 214 | 215 | 213 | 214 |
| | 6000 | -27 | -22 | 1382 | 308 | 616 | 213 | 220 | 212 | 219 | 210 | 218 |
| | 8000 | -31 | -26 | 1382 | 303 | 606 | 211 | 224 | 210 | 223 | 208 | 222 |
| | 10,000 | -35 | -30 | 1382 | 299 | 598 | 208 | 229 | 207 | 228 | 206 | 226 |
| | 12,000 | -39 | -33 | 1382 | 296 | 592 | 206 | 233 | 205 | 232 | 204 | 230 |
| | 14,000 | -43 | -37 | 1382 | 294 | 588 | 204 | 238 | 203 | 236 | 202 | 235 |
| | 16,000 | -47 | -41 | 1382 | 293 | 587 | 202 | 243 | 201 | 241 | 199 | 239 |
| | 18,000 | -51 | -45 | 1382 | 292 | 584 | 200 | 248 | 199 | 246 | 197 | 244 |

EXAMPLE:

Pressure Altitude - 10,000 Feet.
Outside Air Temperature - -15 Degrees Celsius (ISA -10 Degrees Celsius).
Weight - 9000 Pounds.

Airspeed (Approximation Method) - 232 KTAS (204 KIAS).

Fuel Flow (Approximation Method) - 605 pounds per hour total (303 pounds per hour per engine).

**Figure 5-24 (Sheet 1 of 8)
MAXIMUM CRUISE POWER
(1900 RPM)**

NOTE:
1. Do not exceed Maximum Cruise Power.
Table values or 695 degrees Celsius ITT,
whichever occurs first.

- CONDITIONS:
1. Power Levers - Set.
 2. Propeller Control Levers - 1900 RPM
 3. Landing Gear - Up.
 4. Wing Flaps - Up.
 5. Cowl Flaps - As required.
 6. Inertial Separators - Normal.
 7. Heater - As required.

| | PRESSURE ALTITUDE - FEET | OAT °C | IOAT °C | TORQUE - FT-LBS | FUEL FLOW PER ENGINE - LB/HR | TOTAL FUEL FLOW - LB/HR | 7300 POUNDS | | 8300 POUNDS | | 9360 POUNDS | |
|--------------|--------------------------------|-----------|------------|--------------------|---------------------------------------|----------------------------------|----------------|------|----------------|------|----------------|------|
| | | | | | | | KIAS | KTAS | KIAS | KTAS | KIAS | KTAS |
| ISA -20°C | Sea Level | -5 | -1 | 1382 | 334 | 667 | 217 | 211 | 216 | 210 | 215 | 209 |
| | 2000 | -9 | -4 | 1382 | 325 | 650 | 215 | 215 | 214 | 214 | 213 | 213 |
| | 4000 | -13 | -8 | 1382 | 317 | 634 | 213 | 219 | 212 | 218 | 211 | 217 |
| | 6000 | -17 | -12 | 1382 | 310 | 619 | 211 | 223 | 210 | 222 | 209 | 221 |
| | 8000 | -21 | -16 | 1382 | 305 | 609 | 209 | 227 | 208 | 226 | 206 | 225 |
| | 10,000 | -25 | -19 | 1382 | 301 | 601 | 207 | 232 | 206 | 230 | 204 | 229 |
| | 12,000 | -29 | -23 | 1382 | 298 | 595 | 205 | 236 | 204 | 235 | 202 | 233 |
| | 14,000 | -33 | -27 | 1382 | 296 | 591 | 203 | 241 | 201 | 240 | 200 | 238 |
| | 16,000 | -37 | -31 | 1382 | 295 | 590 | 201 | 246 | 199 | 245 | 198 | 243 |
| | 18,000 | -41 | -34 | 1382 | 293 | 587 | 199 | 251 | 197 | 250 | 196 | 247 |
| | 20,000 | -45 | -38 | 1302 | 276 | 552 | 192 | 251 | 190 | 249 | 188 | 246 |
| | 22,000 | -49 | -42 | 1215 | 258 | 515 | 185 | 250 | 183 | 248 | 181 | 244 |
| 24,000 | -53 | -46 | 1132 | 240 | 481 | 178 | 249 | 176 | 246 | 173 | 242 | |

Figure 5-24 (Sheet 2 of 8)
MAXIMUM CRUISE POWER
(1900 RPM)

CONDITIONS:

1. Power Levers - Set.
2. Propeller Control Levers - 1900 RPM
3. Landing Gear - Up.
4. Wing Flaps - Up.
5. Cowl Flaps - As required.
6. Inertial Separators - Normal.
7. Heater - As required.

NOTE:

1. Do not exceed Maximum Cruise Power. Table values are for 695 degrees Celsius ITT, whichever occurs first.

| | PRESSURE ALTITUDE - FEET | OAT °C | IOAT °C | TORQUE - FT-LBS | FUEL FLOW PER ENGINE - LB/HR | TOTAL FUEL FLOW - LB/HR | 7300 POUNDS | | 8300 POUNDS | | 9360 POUNDS | |
|--------------|--------------------------|--------|---------|-----------------|------------------------------|-------------------------|-------------|------|-------------|------|-------------|------|
| | | | | | | | KIAS | KTAS | KIAS | KTAS | KIAS | KTAS |
| ISA -10°C | Sea Level | 5 | 10 | 1382 | 336 | 672 | 216 | 213 | 215 | 212 | 214 | 211 |
| | 2000 | 1 | 6 | 1382 | 327 | 655 | 214 | 217 | 213 | 216 | 212 | 215 |
| | 4000 | -3 | 2 | 1382 | 319 | 638 | 212 | 221 | 211 | 220 | 209 | 219 |
| | 6000 | -7 | -2 | 1382 | 312 | 623 | 210 | 226 | 208 | 224 | 207 | 223 |
| | 8000 | -11 | -6 | 1382 | 307 | 613 | 207 | 230 | 206 | 229 | 205 | 227 |
| | 10,000 | -15 | -9 | 1382 | 303 | 605 | 205 | 234 | 204 | 233 | 204 | 232 |
| | 12,000 | -19 | -13 | 1382 | 299 | 599 | 203 | 239 | 202 | 238 | 200 | 236 |
| 14,000 | -23 | -17 | 1382 | 297 | 594 | 201 | 244 | 200 | 243 | 198 | 241 | |
| 16,000 | -27 | -21 | 1382 | 297 | 593 | 199 | 249 | 198 | 248 | 196 | 246 | |
| 18,000 | -31 | -24 | 1310 | 281 | 562 | 193 | 250 | 191 | 248 | 189 | 245 | |
| 20,000 | -35 | -29 | 1224 | 262 | 524 | 186 | 249 | 184 | 246 | 182 | 243 | |
| 22,000 | -39 | -33 | 1143 | 245 | 489 | 179 | 248 | 177 | 245 | 174 | 241 | |
| 24,000 | -43 | -37 | 1066 | 228 | 456 | 172 | 246 | 170 | 243 | 167 | 238 | |
| 26,000 | -47 | -41 | 991 | 212 | 425 | 165 | 244 | 162 | 240 | 158 | 235 | |
| 28,000 | -51 | -45 | 919 | 198 | 395 | 158 | 242 | 154 | 237 | 150 | 230 | |
| 30,000 | -54 | -49 | 850 | 184 | 369 | 150 | 239 | 146 | 233 | 141 | 224 | |

Figure 5-24 (Sheet 3 of 8)
MAXIMUM CRUISE POWER
(1900 RPM)

NOTE:
1. Do not exceed Maximum Cruise Power Table values or 695 degrees Celsius ITT, whichever occurs first.

CONDITIONS:
1. Power Levers - Set.
2. Propeller Control Levers - 1900 RPM
3. Landing Gear - Up.
4. Wing Flaps - Up.
5. Cowl Flaps - As required.
6. Inertial Separators - Normal.
7. Heater - As required.

| | PRESSURE ALTITUDE - FEET | OAT °C | IOAT °C | TORQUE- FT-LBS | FUEL FLOW PER ENGINE - LB/HR | TOTAL FUEL FLOW - LB/HR | 7300 POUNDS | | 8300 POUNDS | | 9360 POUNDS | |
|--------|--------------------------|--------|---------|----------------|------------------------------|-------------------------|-------------|------|-------------|------|-------------|------|
| | | | | | | | KIAS | KTAS | KIAS | KTAS | KIAS | KTAS |
| ISA | Sea Level | 15 | 20 | 1382 | 339 | 677 | 215 | 216 | 214 | 215 | 212 | 213 |
| | 2000 | 11 | 16 | 1382 | 330 | 660 | 212 | 220 | 211 | 219 | 210 | 217 |
| | 4000 | 7 | 12 | 1382 | 321 | 642 | 210 | 224 | 209 | 223 | 208 | 221 |
| | 6000 | 3 | 8 | 1382 | 314 | 617 | 208 | 228 | 207 | 227 | 206 | 226 |
| | 8000 | -1 | 5 | 1382 | 308 | 617 | 206 | 233 | 205 | 231 | 203 | 230 |
| | 10,000 | -5 | 1 | 1382 | 304 | 609 | 204 | 237 | 202 | 236 | 201 | 234 |
| | 12,000 | -9 | -3 | 1382 | 301 | 603 | 202 | 242 | 200 | 241 | 199 | 239 |
| | 14,000 | -13 | -7 | 1382 | 299 | 597 | 200 | 247 | 198 | 246 | 197 | 244 |
| | 16,000 | -17 | -11 | 1312 | 283 | 567 | 194 | 248 | 192 | 246 | 190 | 243 |
| | 18,000 | -21 | -15 | 1228 | 265 | 531 | 187 | 247 | 185 | 245 | 183 | 242 |
| | 20,000 | -25 | -19 | 1148 | 248 | 496 | 180 | 246 | 178 | 243 | 175 | 240 |
| | 22,000 | -29 | -23 | 1072 | 232 | 464 | 173 | 245 | 171 | 241 | 168 | 237 |
| 24,000 | -33 | -27 | 999 | 216 | 433 | 166 | 243 | 163 | 239 | 160 | 234 | |
| 26,000 | -36 | -31 | 929 | 201 | 403 | 159 | 241 | 156 | 236 | 151 | 230 | |
| 28,000 | -41 | -35 | 861 | 188 | 375 | 152 | 238 | 148 | 233 | 142 | 224 | |
| 30,000 | -44 | -39 | 796 | 175 | 349 | 144 | 235 | 140 | 228 | 133 | 217 | |

Figure 5-24 (Sheet 4 of 8)
MAXIMUM CRUISE POWER
(1900 RPM)

- CONDITIONS:**
1. Power Levers - Set.
 2. Propeller Control Levers - 1900 RPM
 3. Landing Gear - Up.
 4. Wing Flaps - Up.
 5. Cowl Flaps - As required.
 6. Inertial Separators - Normal.
 7. Heater - As required.
- NOTE:**
1. Do not exceed Maximum Cruise Power
whichever occurs first.

| | PRESSURE ALTITUDE - FEET | OAT °C | IOAT °C | TORQUE - FT-LBS | FUEL FLOW PER ENGINE - LB/HR | TOTAL FUEL FLOW - LB/HR | 7300 POUNDS | | 8300 POUNDS | | 9360 POUNDS | |
|--------------|--------------------------------|-----------|------------|--------------------|---------------------------------------|----------------------------------|----------------|------|----------------|------|----------------|------|
| | | | | | | | KIAS | KTAS | KIAS | KTAS | KIAS | KTAS |
| | | | | | | | | | | | | |
| ISA +10°C | Sea Level | 25 | 30 | 1382 | 341 | 683 | 213 | 218 | 212 | 217 | 211 | 216 |
| | 2000 | 21 | 26 | 1382 | 332 | 664 | 211 | 222 | 210 | 221 | 209 | 220 |
| | 4000 | 17 | 22 | 1382 | 323 | 646 | 209 | 226 | 208 | 225 | 206 | 224 |
| | 6000 | 13 | 19 | 1382 | 316 | 632 | 207 | 231 | 205 | 229 | 204 | 228 |
| | 8000 | 9 | 16 | 1382 | 310 | 621 | 204 | 235 | 203 | 234 | 202 | 232 |
| | 10,000 | 5 | 11 | 1382 | 307 | 613 | 202 | 240 | 201 | 239 | 200 | 237 |
| | 12,000 | 1 | 7 | 1369 | 301 | 601 | 200 | 244 | 198 | 243 | 196 | 240 |
| 14,000 | -3 | 3 | 1294 | 283 | 567 | 193 | 244 | 192 | 242 | 190 | 240 | |
| 16,000 | -7 | -1 | 1222 | 267 | 534 | 187 | 244 | 185 | 242 | 183 | 239 | |
| 18,000 | -11 | -5 | 1149 | 251 | 501 | 180 | 244 | 179 | 241 | 176 | 238 | |
| 20,000 | -15 | -9 | 1074 | 234 | 468 | 174 | 242 | 172 | 239 | 169 | 235 | |
| 22,000 | -19 | -13 | 1002 | 219 | 439 | 167 | 241 | 164 | 237 | 161 | 232 | |
| 24,000 | -23 | -17 | 934 | 204 | 408 | 160 | 239 | 157 | 235 | 153 | 229 | |
| 26,000 | -27 | -21 | 868 | 190 | 381 | 153 | 237 | 149 | 232 | 144 | 224 | |
| 28,000 | -31 | -25 | 803 | 177 | 355 | 146 | 234 | 141 | 227 | 135 | 217 | |
| 30,000 | -34 | -30 | 741 | 165 | 330 | 138 | 230 | 132 | 221 | 123 | 207 | |

**Figure 5-24 (Sheet 5 of 8)
MAXIMUM CRUISE POWER
(1900 RPM)**

CONDITIONS:

1. Power Levers - Set.
2. Propeller Control Levers - 1900 RPM
3. Landing Gear - Up.
4. Wing Flaps - Up.
5. Cowl Flaps - As required.
6. Inertial Separators - Normal.
7. Heater - As required.

NOTE:

1. Do not exceed Maximum Cruise Power Table values or 695 degrees Celsius ITT, whichever occurs first.

| | PRESSURE ALTITUDE - FEET | OAT °C | IOAT °C | TORQUE- FT-LBS | FUEL FLOW PER ENGINE - LB/HR | TOTAL FUEL FLOW - LB/HR | 7300 POUNDS | | 8300 POUNDS | | 9360 POUNDS | |
|-----------|--------------------------|--------|---------|----------------|------------------------------|-------------------------|-------------|------|-------------|------|-------------|------|
| | | | | | | | KIAS | KTAS | KIAS | KTAS | KIAS | KTAS |
| ISA +20°C | Sea Level | 35 | 40 | 1382 | 344 | 687 | 212 | 220 | 211 | 219 | 209 | 218 |
| | 2000 | 30 | 36 | 1382 | 334 | 668 | 210 | 224 | 209 | 223 | 207 | 222 |
| | 4000 | 27 | 32 | 1382 | 325 | 651 | 208 | 229 | 206 | 227 | 205 | 226 |
| | 6000 | 23 | 29 | 1382 | 318 | 636 | 205 | 233 | 204 | 232 | 203 | 230 |
| | 8000 | 19 | 25 | 1382 | 312 | 625 | 203 | 238 | 202 | 236 | 200 | 235 |
| | 10,000 | 15 | 21 | 1329 | 298 | 597 | 198 | 239 | 197 | 238 | 195 | 235 |
| | 12,000 | 11 | 17 | 1357 | 281 | 562 | 192 | 239 | 190 | 238 | 188 | 235 |
| | 14,000 | 7 | 13 | 1189 | 265 | 530 | 186 | 239 | 184 | 237 | 182 | 234 |
| | 16,000 | 3 | 9 | 1124 | 250 | 499 | 180 | 239 | 178 | 237 | 175 | 233 |
| | 18,000 | -1 | 5 | 1056 | 234 | 468 | 173 | 238 | 171 | 235 | 168 | 231 |
| | 20,000 | -5 | 1 | 992 | 220 | 439 | 167 | 238 | 164 | 234 | 161 | 229 |
| | 22,000 | -9 | -3 | 930 | 206 | 411 | 161 | 236 | 158 | 232 | 153 | 226 |
| | 24,000 | -13 | -7 | 871 | 193 | 385 | 154 | 235 | 150 | 230 | 146 | 223 |
| | 26,000 | -17 | -11 | 809 | 179 | 358 | 147 | 232 | 143 | 226 | 137 | 217 |
| | 28,000 | -21 | -16 | 748 | 167 | 334 | 139 | 229 | 134 | 221 | 126 | 208 |
| | 30,000 | -25 | -20 | 689 | 155 | 310 | 131 | 224 | 125 | 213 | 111 | 191 |

Figure 5-24 (Sheet 6 of 8)
MAXIMUM CRUISE POWER
(1900 RPM)

CONDITIONS:

1. Power Levers - Set.
2. Propeller Control Levers - 1900 RPM
3. Landing Gear - Up.
4. Wing Flaps - Up.
5. Cowl Flaps - As required.
6. Inertial Separators - Normal.
7. Heater - As required.

NOTE:

1. Do not exceed Maximum Cruise Power Table values or 695 degrees Celsius (ITT), whichever occurs first.

| | PRESSURE ALTITUDE - FEET | OAT °C | IOAT °C | TORQUE - FT-LBS | FUEL FLOW PER ENGINE - LB/HR | TOTAL FUEL FLOW - LB/HR | 7300 POUNDS | | 8300 POUNDS | | 9360 POUNDS | |
|-----------|--------------------------|--------|---------|-----------------|------------------------------|-------------------------|-------------|------|-------------|------|-------------|------|
| | | | | | | | KIAS | KTAS | KIAS | KTAS | KIAS | KTAS |
| | | | | | | | | | | | | |
| ISA +30°C | Sea Level | 45 | 50 | 1382 | 346 | 692 | 210 | 222 | 209 | 221 | 208 | 220 |
| | 2000 | 41 | 46 | 1362 | 337 | 673 | 209 | 227 | 207 | 226 | 206 | 224 |
| | 4000 | 37 | 42 | 1362 | 328 | 655 | 207 | 231 | 205 | 230 | 204 | 228 |
| | 6000 | 33 | 39 | 1358 | 313 | 625 | 202 | 233 | 200 | 231 | 199 | 230 |
| | 8000 | 29 | 35 | 1277 | 296 | 592 | 196 | 234 | 195 | 232 | 193 | 230 |
| | 10,000 | 25 | 31 | 1208 | 278 | 557 | 190 | 234 | 188 | 232 | 186 | 229 |
| | 12,000 | 27 | 27 | 1142 | 262 | 524 | 184 | 234 | 182 | 231 | 180 | 228 |
| | 14,000 | 17 | 23 | 1062 | 247 | 494 | 178 | 234 | 176 | 231 | 173 | 228 |
| | 16,000 | 13 | 19 | 1023 | 233 | 465 | 172 | 233 | 170 | 230 | 167 | 226 |
| | 18,000 | 9 | 15 | 963 | 218 | 436 | 166 | 233 | 163 | 229 | 160 | 224 |
| 20,000 | 5 | 11 | 905 | 205 | 409 | 160 | 232 | 157 | 227 | 153 | 221 | |
| 22,000 | 1 | 7 | 849 | 192 | 383 | 153 | 230 | 150 | 225 | 145 | 218 | |
| 24,000 | -3 | 3 | 794 | 179 | 358 | 147 | 228 | 142 | 222 | 136 | 213 | |
| 26,000 | -7 | -2 | 741 | 168 | 335 | 140 | 226 | 135 | 218 | 127 | 206 | |
| 28,000 | -11 | -6 | 688 | 157 | 313 | 132 | 222 | 126 | 212 | 114 | 192 | |
| 30,000 | -14 | -10 | 636 | 146 | 291 | 125 | 217 | 116 | 203 | --- | --- | |

Figure 5-24 (Sheet 7 of 8)
MAXIMUM CRUISE POWER
(1900 RPM)

CONDITIONS:

1. Power Levers - Set.
2. Propeller Control Levers - 1900 RPM
3. Landing Gear - Up.
4. Wing Flaps - Up.
5. Cowl Flaps - As required.
6. Inertial Separators - Normal.
7. Heater - As required.

NOTE:

1. Do not exceed Maximum Cruise Power. Table values at 695 degrees Celsius ITT, whichever occurs first.

| | PRESSURE ALTITUDE - FEET | OAT °C | IOAT °C | TORQUE- FT-LBS | FUEL FLOW PER ENGINE - LB/HR | TOTAL FUEL FLOW - LB/HR | 7300 POUNDS | | 8300 POUNDS | | 9360 POUNDS | |
|-----------|--------------------------|--------|---------|----------------|------------------------------|-------------------------|-------------|------|-------------|------|-------------|------|
| | | | | | | | KIAS | KTAS | KIAS | KTAS | KIAS | KTAS |
| ISA +37°C | Sea Level | 52 | 57 | 1336 | 341 | 681 | 207 | 221 | 206 | 220 | 205 | 219 |
| | 2000 | 48 | 53 | 1308 | 327 | 653 | 203 | 224 | 202 | 223 | 201 | 221 |
| | 4000 | 44 | 49 | 1275 | 312 | 623 | 200 | 226 | 198 | 225 | 196 | 223 |
| | 6000 | 40 | 45 | 1238 | 297 | 595 | 195 | 228 | 194 | 227 | 192 | 224 |
| | 8000 | 36 | 41 | 1188 | 282 | 564 | 190 | 229 | 188 | 227 | 186 | 225 |
| | 10,000 | 32 | 37 | 1127 | 266 | 531 | 184 | 229 | 182 | 227 | 180 | 224 |
| | 12,000 | 28 | 33 | 1067 | 250 | 500 | 178 | 229 | 176 | 227 | 174 | 224 |
| 14,000 | 24 | 30 | 1010 | 235 | 471 | 172 | 229 | 170 | 226 | 167 | 222 | |
| 16,000 | 20 | 26 | 955 | 221 | 442 | 167 | 229 | 164 | 225 | 161 | 221 | |
| 18,000 | 16 | 21 | 898 | 207 | 415 | 160 | 228 | 157 | 224 | 154 | 218 | |
| 20,000 | 12 | 17 | 844 | 194 | 389 | 154 | 227 | 151 | 222 | 146 | 215 | |
| 22,000 | 8 | 13 | 792 | 182 | 364 | 148 | 225 | 144 | 219 | 138 | 211 | |
| 24,000 | 5 | 9 | 742 | 170 | 341 | 141 | 223 | 136 | 216 | 129 | 205 | |
| 26,000 | 1 | 5 | 692 | 159 | 318 | 134 | 220 | 128 | 211 | 118 | 194 | |
| 28,000 | -4 | 1 | 641 | 148 | 297 | 127 | 216 | 119 | 203 | --- | --- | |
| 30,000 | -7 | -3 | 602 | 139 | 279 | 119 | 210 | --- | --- | --- | --- | |

Figure 5-24 (Sheet 8 of 8)
MAXIMUM CRUISE POWER
(1900 RPM)

- CONDITIONS:**
1. Power Levers - Set.
 2. Propeller Control Levers - 1800 RPM
 3. Landing Gear - Up.
 4. Wing Flaps - Up.
 5. Cowl Flaps - As required.
 6. Inertial Separators - Normal.
 7. Heater - As required.

- NOTE:**
1. Do not exceed Maximum Cruise Power Table values or 695 degrees Celsius ITT, whichever occurs first.

| | PRESSURE ALTITUDE - FEET | OAT °C | IOAT °C | TORQUE - FT-LBS | FUEL FLOW PER ENGINE - LB/HR | TOTAL FUEL FLOW - LB/HR | 7300 POUNDS | | 8300 POUNDS | | 9360 POUNDS | |
|--------------|--------------------------|--------|---------|-----------------|------------------------------|-------------------------|-------------|------|-------------|------|-------------|------|
| | | | | | | | KIAS | KTAS | KIAS | KTAS | KIAS | KTAS |
| ISA -30°C | Sea Level | -15 | -11 | 1459 | 332 | 664 | 219 | 208 | 218 | 207 | 217 | 206 |
| | 2000 | -19 | -14 | 1459 | 324 | 648 | 217 | 212 | 216 | 211 | 214 | 210 |
| | 4000 | -23 | -18 | 1459 | 316 | 632 | 215 | 216 | 214 | 215 | 212 | 214 |
| | 6000 | -27 | -22 | 1459 | 310 | 620 | 212 | 220 | 211 | 219 | 210 | 218 |
| | 8000 | -31 | -26 | 1459 | 305 | 610 | 210 | 224 | 209 | 223 | 208 | 222 |
| | 10,000 | -35 | -30 | 1459 | 301 | 602 | 208 | 228 | 207 | 227 | 206 | 226 |
| | 12,000 | -39 | -33 | 1459 | 299 | 598 | 206 | 233 | 205 | 232 | 204 | 230 |
| | 14,000 | -43 | -37 | 1459 | 297 | 594 | 204 | 238 | 203 | 236 | 201 | 235 |
| | 16,000 | -47 | -41 | 1459 | 296 | 592 | 202 | 243 | 201 | 241 | 199 | 239 |
| | 18,000 | -51 | -45 | 1459 | 295 | 590 | 200 | 248 | 199 | 246 | 197 | 244 |

EXAMPLE:

Pressure Altitude - 10,000 Feet.
Outside Air Temperature - -15 Degrees Celsius (ISA -10 Degrees Celsius).
Weight - 9000 Pounds.

Airspeed (Approximation Method) - 231 KTAS (202 KIAS).
Fuel Flow (Approximation Method) - 610 pounds per hour total (305 pounds per hour per engine).

**Figure 5-25 (Sheet 1 of 8)
MAXIMUM CRUISE POWER
(1800 RPM)**

CONDITIONS:

1. Power Levers - Set.
2. Propeller Control Levers - 1800 RPM
3. Landing Gear - Up.
4. Wing Flaps - Up.
5. Cowl Flaps - As required.
6. Inertial Separators - Normal.
7. Heater - As required.

NOTE:

1. Do not exceed Maximum Cruise Power Table values or 695 degrees Celsius ITT, whichever occurs first.

| | PRESSURE ALTITUDE - FEET | OAT °C | IOAT °C | TORQUE - FT-LBS | FUEL FLOW PER ENGINE - LB/HR | TOTAL FUEL FLOW - LB/HR | 7300 POUNDS | | 8300 POUNDS | | 9360 POUNDS | |
|--------------|--------------------------|--------|---------|-----------------|------------------------------|-------------------------|-------------|------|-------------|------|-------------|------|
| | | | | | | | KIAS | KTAS | KIAS | KTAS | KIAS | KTAS |
| ISA -20°C | Sea Level | -5 | -1 | 1459 | 334 | 668 | 217 | 211 | 216 | 210 | 215 | 209 |
| | 2000 | -9 | -4 | 1459 | 326 | 652 | 215 | 214 | 214 | 213 | 213 | 212 |
| | 4000 | -13 | -8 | 1459 | 318 | 636 | 213 | 218 | 212 | 217 | 211 | 216 |
| | 6000 | -17 | -12 | 1459 | 312 | 624 | 211 | 223 | 210 | 221 | 208 | 220 |
| | 8000 | -21 | -16 | 1459 | 307 | 614 | 209 | 227 | 208 | 226 | 206 | 224 |
| | 10,000 | -25 | -19 | 1459 | 303 | 606 | 207 | 231 | 205 | 230 | 204 | 229 |
| | 12,000 | -29 | -23 | 1459 | 300 | 600 | 205 | 236 | 203 | 235 | 202 | 233 |
| 14,000 | -33 | -27 | 1459 | 299 | 598 | 203 | 241 | 201 | 239 | 200 | 238 | |
| 16,000 | -37 | -31 | 1459 | 298 | 596 | 200 | 246 | 199 | 244 | 198 | 242 | |
| 18,000 | -41 | -34 | 1449 | 295 | 590 | 198 | 250 | 196 | 248 | 194 | 246 | |
| 20,000 | -45 | -38 | 1354 | 276 | 552 | 191 | 249 | 189 | 246 | 187 | 245 | |
| 22,000 | -49 | -42 | 1263 | 257 | 514 | 184 | 248 | 182 | 244 | 179 | 242 | |
| 24,000 | -53 | -47 | 1178 | 240 | 480 | 177 | 247 | 174 | 244 | 172 | 240 | |

Figure 5-25 (Sheet 2 of 8)
MAXIMUM CRUISE POWER
(1800 RPM)

- CONDITIONS:
1. Power Levers - Set.
 2. Propeller Control Levers - 1800 RPM
 3. Landing Gear - Up.
 4. Wing Flaps - Up.
 5. Cowi Flaps - As required.
 6. Inertial Separators - Normal.
 7. Heater - As required.

NOTE:
1. Do not exceed Maximum Cruise Power. Table values or 695 degrees Celsius ITT, whichever occurs first.

| | PRESSURE ALTITUDE - FEET | OAT °C | IOAT °C | TORQUE- FT-LBS | FUEL FLOW PER ENGINE - LB/HR | TOTAL FUEL FLOW - LB/HR | 7300 POUNDS | | 8300 POUNDS | | 9360 POUNDS | |
|--------------|--------------------------|--------|---------|----------------|------------------------------|-------------------------|-------------|------|-------------|------|-------------|------|
| | | | | | | | KIAS | KTAS | KIAS | KTAS | KIAS | KTAS |
| ISA -10°C | Sea Level | 5 | 10 | 1459 | 337 | 674 | 216 | 213 | 215 | 212 | 213 | 211 |
| | 2000 | 1 | 6 | 1459 | 328 | 656 | 213 | 217 | 212 | 216 | 211 | 215 |
| | 4000 | -3 | 2 | 1459 | 321 | 642 | 211 | 221 | 210 | 220 | 209 | 219 |
| | 6000 | -7 | -2 | 1459 | 314 | 628 | 209 | 225 | 208 | 224 | 207 | 223 |
| | 8000 | -11 | -6 | 1459 | 309 | 618 | 207 | 230 | 206 | 228 | 205 | 227 |
| | 10,000 | -15 | -9 | 1459 | 305 | 610 | 205 | 234 | 204 | 233 | 202 | 231 |
| | 12,000 | -19 | -13 | 1459 | 302 | 604 | 203 | 239 | 202 | 238 | 200 | 236 |
| 14,000 | -23 | -17 | 1459 | 300 | 600 | 201 | 244 | 200 | 242 | 198 | 241 | |
| 16,000 | -27 | -21 | 1457 | 300 | 600 | 199 | 249 | 197 | 247 | 195 | 245 | |
| 18,000 | -31 | -25 | 1363 | 280 | 560 | 192 | 248 | 190 | 246 | 188 | 243 | |
| 20,000 | -35 | -29 | 1274 | 262 | 524 | 185 | 247 | 183 | 244 | 181 | 242 | |
| 22,000 | -39 | -33 | 1169 | 244 | 488 | 178 | 246 | 176 | 243 | 173 | 239 | |
| 24,000 | -43 | -37 | 1109 | 228 | 456 | 171 | 244 | 168 | 241 | 165 | 237 | |
| 26,000 | -47 | -41 | 1031 | 212 | 424 | 164 | 243 | 161 | 238 | 157 | 233 | |
| 28,000 | -51 | -45 | 956 | 198 | 396 | 156 | 240 | 153 | 235 | 148 | 228 | |
| 30,000 | -54 | -49 | 884 | 184 | 368 | 149 | 237 | 145 | 231 | 139 | 222 | |

Figure 5-25 (Sheet 3 of 8)
MAXIMUM CRUISE POWER
(1800 RPM)

- CONDITIONS:**
1. Power Levers - Set.
 2. Propeller Control Levers - 1800 RPM
 3. Landing Gear - Up.
 4. Wing Flaps - Up.
 5. Cowl Flaps - As required.
 6. Inertial Separators - Normal.
 7. Heater - As required.
- NOTE:**
1. Do not exceed Maximum Cruise Power Table values or 695 degrees Celsius ITT, whichever occurs first.

| | PRESSURE ALTITUDE - FEET | OAT °C | IOAT °C | TORQUE - FT-LBS | FUEL FLOW PER ENGINE - LB/HR | TOTAL FUEL FLOW - LB/HR | 7300 POUNDS | | 8300 POUNDS | | 9360 POUNDS | |
|--------|--------------------------|--------|---------|-----------------|------------------------------|-------------------------|-------------|------|-------------|------|-------------|------|
| | | | | | | | KIAS | KTAS | KIAS | KTAS | KIAS | KTAS |
| ISA | Sea Level | 15 | 20 | 1459 | 340 | 680 | 214 | 215 | 213 | 214 | 212 | 213 |
| | 2000 | 11 | 16 | 1439 | 331 | 662 | 212 | 219 | 211 | 218 | 210 | 217 |
| | 4000 | 7 | 12 | 1459 | 323 | 646 | 210 | 224 | 209 | 222 | 207 | 221 |
| | 6000 | 3 | 8 | 1459 | 316 | 632 | 208 | 228 | 207 | 227 | 205 | 225 |
| | 8000 | -1 | 6 | 1439 | 311 | 622 | 206 | 232 | 205 | 231 | 203 | 230 |
| | 10,000 | -5 | 1 | 1459 | 307 | 614 | 204 | 237 | 203 | 236 | 201 | 234 |
| | 12,000 | -9 | -3 | 1439 | 304 | 608 | 202 | 242 | 200 | 241 | 199 | 239 |
| | 14,000 | -13 | -7 | 1456 | 301 | 602 | 199 | 247 | 198 | 245 | 196 | 243 |
| | 16,000 | -17 | -11 | 1367 | 283 | 566 | 193 | 246 | 191 | 244 | 189 | 242 |
| | 18,000 | -21 | -15 | 1279 | 265 | 530 | 186 | 245 | 184 | 243 | 182 | 240 |
| | 20,000 | -25 | -19 | 1195 | 248 | 496 | 179 | 244 | 177 | 241 | 174 | 238 |
| | 22,000 | -29 | -23 | 1116 | 232 | 464 | 172 | 243 | 170 | 240 | 166 | 235 |
| | 24,000 | -33 | -27 | 1040 | 216 | 532 | 165 | 241 | 162 | 238 | 158 | 232 |
| | 26,000 | -37 | -31 | 967 | 201 | 402 | 158 | 239 | 155 | 235 | 150 | 228 |
| 28,000 | -41 | -35 | 896 | 187 | 374 | 151 | 237 | 147 | 231 | 141 | 222 | |
| 30,000 | -44 | -39 | 828 | 174 | 348 | 143 | 233 | 138 | 226 | 131 | 214 | |

Figure 5-25 (Sheet 4 of 8)
**MAXIMUM CRUISE POWER
(1800 RPM)**

- CONDITIONS:**
1. Power Levers - Set.
 2. Propeller Control Levers - 1800 RPM
 3. Landing Gear - Up.
 4. Wing Flaps - Up.
 5. Cowl Flaps - As required.
 6. Inertial Separators - Normal.
 7. Heater - As required.

- NOTE:**
1. Do not exceed Maximum Cruise Power Table values or 695 degrees Celsius ITT, whichever occurs first.

| | PRESSURE ALTITUDE - FEET | OAT °C | IOAT °C | TORQUE- FT-LBS | FUEL FLOW PER ENGINE - LB/HR | TOTAL FUEL FLOW - LB/HR | 7300 POUNDS | | 8300 POUNDS | | 9360 POUNDS | |
|-----------|--------------------------|--------|---------|----------------|------------------------------|-------------------------|-------------|------|-------------|------|-------------|------|
| | | | | | | | KIAS | KTAS | KIAS | KTAS | KIAS | KTAS |
| ISA +10°C | Sea Level | 25 | 30 | 1459 | 343 | 686 | 213 | 218 | 212 | 217 | 210 | 215 |
| | 2000 | 21 | 26 | 1459 | 334 | 668 | 211 | 222 | 210 | 221 | 208 | 219 |
| | 4000 | 17 | 22 | 1459 | 326 | 652 | 208 | 226 | 207 | 225 | 206 | 223 |
| | 6000 | 13 | 18 | 1459 | 319 | 618 | 206 | 230 | 205 | 229 | 204 | 228 |
| | 8000 | 9 | 15 | 1459 | 313 | 626 | 204 | 235 | 203 | 234 | 202 | 232 |
| | 10,000 | 5 | 11 | 1459 | 309 | 618 | 202 | 240 | 201 | 239 | 200 | 237 |
| | 12,000 | 1 | 7 | 1429 | 300 | 600 | 199 | 243 | 197 | 241 | 196 | 239 |
| 14,000 | -3 | 3 | 1351 | 283 | 566 | 192 | 243 | 191 | 241 | 189 | 239 | |
| 16,000 | -7 | -1 | 1275 | 267 | 534 | 186 | 243 | 184 | 241 | 182 | 238 | |
| 18,000 | -11 | -5 | 1198 | 250 | 500 | 180 | 242 | 178 | 240 | 175 | 236 | |
| 20,000 | -15 | -9 | 1119 | 234 | 468 | 173 | 241 | 170 | 238 | 168 | 234 | |
| 22,000 | -19 | -13 | 1044 | 218 | 436 | 166 | 240 | 163 | 236 | 160 | 231 | |
| 24,000 | -23 | -17 | 972 | 204 | 408 | 159 | 238 | 156 | 233 | 152 | 227 | |
| 26,000 | -27 | -21 | 904 | 190 | 380 | 152 | 235 | 148 | 230 | 143 | 222 | |
| 28,000 | -31 | -25 | 837 | 177 | 354 | 145 | 232 | 140 | 225 | 133 | 215 | |
| 30,000 | -34 | -30 | 772 | 165 | 330 | 137 | 228 | 131 | 219 | 121 | 203 | |

**Figure 5-25 (Sheet 5 of 8)
MAXIMUM CRUISE POWER
(1800 RPM)**

CONDITIONS:

1. Power Levers - Set.
2. Propeller Control Levers - 1800 RPM
3. Landing Gear - Up.
4. Wing Flaps - Up.
5. Cowl Flaps - As required.
6. Inertial Separators - Normal.
7. Heater - As required.

NOTE:

1. Do not exceed Maximum Cruise Power Table values or 695 degrees Celsius ITT, whichever occurs first.

| ISA +20°C | PRESSURE ALTITUDE - FEET | OAT °C | IOAT °C | TORQUE- FT-LBS | FUEL FLOW PER ENGINE - LB/HR | TOTAL FUEL FLOW - LB/HR | 7300 | | 8300 | | 9360 | |
|--------------|--------------------------------|-----------|------------|-------------------|---------------------------------------|----------------------------------|--------|------|--------|------|--------|------|
| | | | | | | | POUNDS | | POUNDS | | POUNDS | |
| | | | | | | | KIAS | KTAS | KIAS | KTAS | KIAS | KTAS |
| | Sea Level | 35 | 40 | 1459 | 346 | 692 | 211 | 220 | 210 | 219 | 209 | 217 |
| | 2000 | 31 | 36 | 1459 | 337 | 674 | 209 | 224 | 208 | 223 | 207 | 222 |
| | 4000 | 27 | 32 | 1459 | 328 | 656 | 207 | 228 | 206 | 227 | 205 | 226 |
| | 6000 | 23 | 29 | 1459 | 321 | 642 | 205 | 233 | 204 | 232 | 202 | 230 |
| | 8000 | 19 | 25 | 1459 | 315 | 630 | 203 | 238 | 202 | 236 | 200 | 235 |
| | 10,000 | 15 | 21 | 1387 | 298 | 596 | 197 | 238 | 196 | 237 | 194 | 234 |
| | 12,000 | 11 | 17 | 1312 | 281 | 562 | 191 | 238 | 189 | 236 | 187 | 234 |
| | 14,000 | 7 | 13 | 1241 | 265 | 530 | 185 | 238 | 183 | 236 | 181 | 233 |
| | 16,000 | 3 | 9 | 1172 | 250 | 500 | 179 | 238 | 177 | 235 | 174 | 232 |
| | 18,000 | -1 | 5 | 1102 | 234 | 468 | 172 | 237 | 170 | 234 | 167 | 230 |
| | 20,000 | -5 | 1 | 1035 | 219 | 438 | 166 | 236 | 164 | 233 | 160 | 227 |
| | 22,000 | -9 | -3 | 970 | 206 | 412 | 160 | 235 | 157 | 231 | 152 | 225 |
| | 24,000 | -13 | -7 | 908 | 192 | 384 | 153 | 234 | 150 | 228 | 144 | 221 |
| | 26,000 | -17 | -12 | 843 | 179 | 358 | 146 | 231 | 142 | 224 | 135 | 215 |
| | 28,000 | -21 | -16 | 779 | 167 | 334 | 138 | 227 | 133 | 219 | 124 | 205 |
| | 30,000 | -24 | -20 | 717 | 155 | 310 | 130 | 223 | 123 | 211 | --- | --- |

Figure 5-25 (Sheet 6 of 8)
MAXIMUM CRUISE POWER
(1800 RPM)

CONDITIONS:

1. Power Levers - Set.
2. Propeller Control Levers - 1800 RPM
3. Landing Gear - Up.
4. Wing Flaps - Up.
5. Cowl Flaps - As required.
6. Inertial Separators - Normal.
7. Heater - As required.

- NOTE:
1. Do not exceed Maximum Cruise Power. Table values or 695 degrees Celsius (ITT), whichever occurs first.

| | PRESSURE ALTITUDE - FEET | OAT °C | IOAT °C | TORQUE - FT-LBS | FUEL FLOW PER ENGINE - LB/HR | TOTAL FUEL FLOW - LB/HR | 7300 POUNDS | | 8300 POUNDS | | 9360 POUNDS | |
|-----------|--------------------------|--------|---------|-----------------|------------------------------|-------------------------|-------------|------|-------------|------|-------------|------|
| | | | | | | | KIAS | KTAS | KIAS | KTAS | KIAS | KTAS |
| | | | | | | | | | | | | |
| ISA +30°C | Sea Level | 45 | 50 | 1459 | 348 | 690 | 210 | 222 | 209 | 221 | 208 | 220 |
| | 2000 | 41 | 46 | 1459 | 339 | 678 | 208 | 226 | 207 | 225 | 206 | 224 |
| | 4000 | 37 | 42 | 1444 | 328 | 656 | 205 | 230 | 204 | 229 | 202 | 227 |
| | 6000 | 33 | 39 | 1396 | 313 | 626 | 201 | 232 | 199 | 230 | 198 | 228 |
| | 8000 | 29 | 35 | 1333 | 296 | 592 | 196 | 233 | 194 | 231 | 192 | 229 |
| | 10,000 | 25 | 31 | 1260 | 278 | 556 | 189 | 232 | 187 | 230 | 185 | 228 |
| | 12,000 | 21 | 27 | 1192 | 262 | 524 | 183 | 232 | 181 | 230 | 179 | 227 |
| | 14,000 | 17 | 23 | 1129 | 247 | 494 | 177 | 232 | 175 | 230 | 172 | 226 |
| | 16,000 | 13 | 19 | 1067 | 232 | 464 | 171 | 232 | 169 | 229 | 166 | 225 |
| | 18,000 | 9 | 15 | 1004 | 218 | 436 | 165 | 231 | 162 | 228 | 159 | 223 |
| | 20,000 | 5 | 11 | 944 | 204 | 408 | 159 | 230 | 155 | 226 | 151 | 220 |
| | 22,000 | 2 | 7 | 885 | 191 | 382 | 152 | 229 | 149 | 224 | 144 | 216 |
| | 24,000 | -3 | 2 | 829 | 179 | 358 | 146 | 227 | 141 | 220 | 135 | 211 |
| | 26,000 | -7 | -2 | 773 | 167 | 334 | 139 | 224 | 133 | 216 | 125 | 203 |
| 28,000 | -11 | -6 | 717 | 156 | 312 | 131 | 221 | 125 | 210 | --- | --- | |
| 30,000 | -14 | -10 | 662 | 145 | 290 | 123 | 215 | 114 | 199 | --- | --- | |

Figure 5-25 (Sheet 7 of 8)
MAXIMUM CRUISE POWER
(1800 RPM)

NOTE:
1. Do not exceed Maximum Cruise Power Table values or 695 degrees Celsius ITT, whichever occurs first.

CONDITIONS:
1. Power Levers - Set.
2. Propeller Control Levers - 1800 RPM
3. Landing Gear - Up.
4. Wing Flaps - Up.
5. Cowl Flaps - As required.
6. Inertial Separators - Normal.
7. Heater - As required.

| ISA +37°C | PRESSURE ALTITUDE - FEET | OAT °C | IOAT °C | TORQUE- FT-LBS | FUEL FLOW PER ENGINE - LB/HR | TOTAL FUEL FLOW - LB/HR | 7300 POUNDS | | 8300 POUNDS | | 9360 POUNDS | |
|--------------|--------------------------------|-----------|------------|-------------------|---------------------------------------|----------------------------------|----------------|------|----------------|------|----------------|------|
| | | | | | | | KIAS | KTAS | KIAS | KTAS | KIAS | KTAS |
| | Sea Level | 52 | 57 | 1396 | 341 | 682 | 206 | 220 | 205 | 219 | 203 | 217 |
| | 2000 | 48 | 53 | 1365 | 326 | 652 | 202 | 223 | 201 | 221 | 199 | 219 |
| | 4000 | 44 | 49 | 1329 | 312 | 624 | 198 | 225 | 197 | 223 | 195 | 221 |
| | 6000 | 40 | 45 | 1292 | 297 | 594 | 194 | 227 | 193 | 225 | 191 | 223 |
| | 8000 | 36 | 41 | 1239 | 282 | 564 | 189 | 228 | 187 | 226 | 185 | 224 |
| | 10,000 | 32 | 37 | 1175 | 266 | 532 | 183 | 228 | 181 | 226 | 179 | 223 |
| | 12,000 | 28 | 33 | 1112 | 250 | 500 | 177 | 228 | 175 | 225 | 173 | 222 |
| | 14,000 | 24 | 29 | 1053 | 235 | 470 | 171 | 228 | 169 | 225 | 166 | 221 |
| | 16,000 | 20 | 25 | 996 | 221 | 442 | 166 | 227 | 163 | 224 | 159 | 219 |
| | 18,000 | 16 | 21 | 936 | 207 | 414 | 159 | 226 | 156 | 222 | 152 | 217 |
| | 20,000 | 12 | 17 | 880 | 194 | 388 | 153 | 225 | 150 | 220 | 145 | 213 |
| | 22,000 | 8 | 13 | 826 | 182 | 364 | 147 | 224 | 143 | 218 | 137 | 209 |
| | 24,000 | 5 | 9 | 774 | 170 | 340 | 140 | 222 | 135 | 214 | 127 | 202 |
| | 26,000 | 1 | 5 | 720 | 159 | 318 | 133 | 218 | 127 | 208 | 115 | 190 |
| | 28,000 | -4 | 1 | 667 | 148 | 296 | 125 | 214 | 117 | 200 | --- | --- |
| | 30,000 | -7 | -3 | 627 | 139 | 278 | 117 | 207 | --- | --- | --- | --- |

Figure 5-25 (Sheet 8 of 8)
MAXIMUM CRUISE POWER
(1800 RPM)

- CONDITIONS:
1. Power Levers - Set.
 2. Propeller Control Levers - 1700 RPM
 3. Landing Gear - Up.
 4. Wing Flaps - Up.
 5. Cowl Flaps - As required.
 6. Inertial Separators - Normal.
 7. Heater - As required.

NOTE:

1. Do not exceed Maximum Cruise Power Table values or 695 degrees Celsius (ITT), whichever occurs first.

| | PRESSURE ALTITUDE - FEET | OAT °C | IOAT °C | TORQUE - FT-LBS | FUEL FLOW PER ENGINE - LB/HR | TOTAL FUEL FLOW - LB/HR | 7300 POUNDS | | 8300 POUNDS | | 9350 POUNDS | |
|--------------|--------------------------|--------|---------|-----------------|------------------------------|-------------------------|-------------|------|-------------|------|-------------|------|
| | | | | | | | KIAS | KTAS | KIAS | KTAS | KIAS | KTAS |
| ISA -30°C | Sea Level | -15 | -11 | 1477 | 324 | 648 | 215 | 205 | 214 | 204 | 213 | 203 |
| | 2000 | -19 | -15 | 1477 | 316 | 632 | 213 | 208 | 212 | 207 | 211 | 206 |
| | 4000 | -23 | -18 | 1477 | 309 | 618 | 211 | 212 | 210 | 211 | 208 | 210 |
| | 6000 | -27 | -22 | 1477 | 302 | 604 | 209 | 216 | 208 | 215 | 206 | 214 |
| | 8000 | -31 | -26 | 1477 | 297 | 594 | 207 | 220 | 206 | 219 | 204 | 218 |
| | 10,000 | -35 | -30 | 1477 | 293 | 586 | 205 | 225 | 204 | 224 | 202 | 222 |
| | 12,000 | -39 | -34 | 1477 | 291 | 582 | 203 | 229 | 202 | 228 | 200 | 226 |
| | 14,000 | -43 | -37 | 1477 | 289 | 578 | 201 | 234 | 199 | 232 | 198 | 230 |
| | 16,000 | -47 | -41 | 1477 | 289 | 578 | 198 | 238 | 197 | 237 | 196 | 235 |
| | 18,000 | -51 | -45 | 1477 | 289 | 578 | 196 | 243 | 195 | 241 | 193 | 239 |

EXAMPLE:
 Pressure Altitude - 10,000 Feet.
 Outside Air Temperature - -15 Degrees Celsius (ISA - 10 Degrees Celsius).
 Weight - 9000 Pounds.
 Airspeed (Approximation Method) - 228 KTAS (199 KIAS).
 Fuel Flow (Approximation Method) - 596 pounds per hour total (298 pounds per hour per engine).

Figure 5-26 (Sheet 1 of 8)
MAXIMUM CRUISE POWER
 (1700 RPM)

NOTE: 1. Do not exceed Maximum Cruise Power Table values or 695 degrees Celsius ITT, whichever occurs first.

CONDITIONS:
1. Power Levers - Set.
2. Propeller Control Levers - 1700 RPM
3. Landing Gear - Up.
4. Wing Flaps - Up.
5. Cowf Flaps - As required.
6. Inertial Separators - Normal.
7. Heater - As required.

| | PRESSURE ALTITUDE - FEET | OAT °C | IOAT °C | TORQUE- FT-LBS | FUEL FLOW PER ENGINE - LB/HR | TOTAL FUEL FLOW - LB/HR | 7300 POUNDS | | 8300 POUNDS | | 9360 POUNDS | |
|--------------|--------------------------|--------|---------|----------------|------------------------------|-------------------------|-------------|------|-------------|------|-------------|------|
| | | | | | | | KIAS | KTAS | KIAS | KTAS | KIAS | KTAS |
| ISA -20°C | Sea Level | -5 | -1 | 1477 | 327 | 654 | 213 | 207 | 212 | 206 | 211 | 205 |
| | 2000 | -9 | -5 | 1477 | 319 | 618 | 211 | 211 | 210 | 210 | 209 | 209 |
| | 4000 | -13 | -8 | 1477 | 311 | 622 | 209 | 215 | 208 | 214 | 207 | 212 |
| | 6000 | -17 | -12 | 1477 | 304 | 608 | 207 | 219 | 206 | 218 | 205 | 216 |
| | 8000 | -21 | -16 | 1477 | 299 | 598 | 205 | 223 | 204 | 222 | 203 | 220 |
| | 10,000 | -25 | -20 | 1477 | 295 | 590 | 203 | 228 | 202 | 226 | 201 | 225 |
| | 12,000 | -29 | -23 | 1477 | 293 | 586 | 201 | 232 | 200 | 231 | 198 | 229 |
| | 14,000 | -33 | -27 | 1477 | 291 | 582 | 199 | 237 | 198 | 235 | 196 | 233 |
| | 16,000 | -37 | -31 | 1477 | 292 | 584 | 197 | 241 | 195 | 240 | 194 | 238 |
| | 18,000 | -41 | -35 | 1477 | 291 | 582 | 194 | 246 | 193 | 244 | 191 | 242 |
| | 20,000 | -45 | -39 | 1402 | 275 | 550 | 188 | 246 | 187 | 244 | 184 | 241 |
| | 22,000 | -49 | -43 | 1308 | 257 | 514 | 181 | 245 | 179 | 243 | 177 | 239 |
| 24,000 | -53 | -47 | 1219 | 240 | 480 | 174 | 244 | 172 | 241 | 169 | 237 | |

Figure 5-26 (Sheet 2 of 8)
MAXIMUM CRUISE POWER
(1700 RPM)

- CONDITIONS:**
1. Power Levers - Set.
 2. Propeller Control Levers - 1700 RPM
 3. Landing Gear - Up.
 4. Wing Flaps - Up.
 5. Cowl Flaps - As required.
 6. Inertial Separators - Normal.
 7. Heater - As required.

- NOTE:**
1. Do not exceed Maximum Cruise Power Table values or 695 degrees Celsius ITT, whichever occurs first.

| ISA -10°C | PRESSURE ALTITUDE - FEET | OAT °C | IOAT °C | TORQUE- FT-LBS | FUEL FLOW PER ENGINE - LB/HR | TOTAL FUEL FLOW - LB/HR | 7300 POUNDS | | 8300 POUNDS | | 9360 POUNDS | |
|--------------|--------------------------------|-----------|------------|-------------------|---------------------------------------|----------------------------------|----------------|------|----------------|------|----------------|------|
| | | | | | | | KIAS | KTAS | KIAS | KTAS | KIAS | KTAS |
| | Sea Level | 5 | 9 | 1477 | 330 | 660 | 212 | 209 | 211 | 208 | 210 | 207 |
| | 2000 | 1 | 6 | 1477 | 322 | 644 | 210 | 213 | 209 | 212 | 207 | 211 |
| | 4000 | -3 | 2 | 1477 | 314 | 628 | 208 | 217 | 207 | 216 | 205 | 215 |
| | 6000 | -7 | -2 | 1477 | 307 | 614 | 206 | 222 | 205 | 220 | 203 | 219 |
| | 8000 | -11 | -6 | 1477 | 301 | 602 | 204 | 226 | 203 | 225 | 201 | 223 |
| | 10,000 | -15 | -10 | 1477 | 298 | 596 | 202 | 231 | 200 | 229 | 199 | 228 |
| | 12,000 | -19 | -13 | 1477 | 295 | 590 | 200 | 235 | 198 | 234 | 197 | 232 |
| | 14,000 | -23 | -17 | 1477 | 293 | 586 | 197 | 240 | 196 | 238 | 194 | 236 |
| | 16,000 | -27 | -21 | 1477 | 294 | 584 | 195 | 244 | 193 | 243 | 192 | 240 |
| | 18,000 | -31 | -25 | 1410 | 280 | 560 | 189 | 245 | 188 | 243 | 186 | 240 |
| | 20,000 | -35 | -29 | 1319 | 261 | 532 | 183 | 244 | 181 | 242 | 178 | 238 |
| | 22,000 | -39 | -33 | 1231 | 244 | 488 | 176 | 243 | 173 | 240 | 170 | 236 |
| | 24,000 | -43 | -37 | 1148 | 228 | 456 | 169 | 241 | 166 | 238 | 163 | 233 |
| | 26,000 | -47 | -41 | 1067 | 212 | 424 | 162 | 239 | 159 | 235 | 155 | 229 |
| | 28,000 | -51 | -45 | 989 | 197 | 394 | 154 | 237 | 151 | 232 | 146 | 224 |
| | 30,000 | -54 | -49 | 915 | 184 | 368 | 147 | 234 | 143 | 227 | 136 | 218 |

**Figure 5-26 (Sheet 3 of 8)
MAXIMUM CRUISE POWER
(1700 RPM)**

NOTE:
1. Do not exceed Maximum Cruise Power Table values or 695 degrees Celsius ITT, whichever occurs first.

- CONDITIONS:
1. Power Levers - Set.
 2. Propeller Control Levers - 1700 RPM
 3. Landing Gear - Up.
 4. Wing Flaps - Up.
 5. Cowl Flaps - As required.
 6. Inertial Separators - Normal.
 7. Heater - As required.

| | PRESSURE ALTITUDE - FEET | OAT °C | IOAT °C | TORQUE- FT-LBS | FUEL FLOW PER ENGINE - LB/HR | TOTAL FUEL FLOW - LB/HR | 7300 POUNDS | | 8300 POUNDS | | 9360 POUNDS | |
|--------|--------------------------|--------|---------|----------------|------------------------------|-------------------------|-------------|------|-------------|------|-------------|------|
| | | | | | | | KIAS | KTAS | KIAS | KTAS | KIAS | KTAS |
| ISA | Sea Level | 15 | 20 | 1477 | 333 | 666 | 211 | 212 | 209 | 211 | 208 | 209 |
| | 2000 | 11 | 16 | 1477 | 324 | 648 | 208 | 216 | 207 | 215 | 206 | 213 |
| | 4000 | 7 | 12 | 1477 | 316 | 632 | 206 | 220 | 205 | 219 | 204 | 217 |
| | 6000 | 3 | 8 | 1477 | 309 | 618 | 204 | 224 | 203 | 223 | 202 | 222 |
| | 8000 | -1 | 4 | 1477 | 304 | 608 | 202 | 229 | 201 | 227 | 200 | 226 |
| | 10,000 | -5 | 1 | 1477 | 300 | 600 | 200 | 233 | 199 | 232 | 197 | 230 |
| | 12,000 | -9 | -3 | 1477 | 298 | 596 | 198 | 238 | 197 | 236 | 195 | 234 |
| | 14,000 | -13 | -7 | 1477 | 296 | 592 | 196 | 242 | 194 | 241 | 192 | 239 |
| | 16,000 | -17 | -11 | 1415 | 283 | 568 | 190 | 243 | 189 | 241 | 187 | 239 |
| | 18,000 | -21 | -15 | 1324 | 265 | 430 | 183 | 242 | 182 | 240 | 179 | 237 |
| 20,000 | -25 | -19 | 1237 | 247 | 494 | 177 | 241 | 174 | 238 | 172 | 235 | |
| 22,000 | -29 | -23 | 1155 | 231 | 462 | 170 | 240 | 167 | 237 | 164 | 232 | |
| 24,000 | -33 | -27 | 1076 | 216 | 432 | 163 | 238 | 160 | 234 | 156 | 229 | |
| 26,000 | -37 | -31 | 1000 | 201 | 402 | 156 | 236 | 152 | 231 | 148 | 224 | |
| 28,000 | -41 | -35 | 926 | 187 | 374 | 148 | 233 | 144 | 227 | 138 | 218 | |
| 30,000 | -44 | -39 | 856 | 174 | 348 | 141 | 230 | 136 | 222 | 128 | 209 | |

Figure 5-26 (Sheet 4 of 8)
MAXIMUM CRUISE POWER
(1700 RPM)

NOTE: Do not exceed Maximum Cruise Power.
Table values at 685 degrees Celsius (TT),
whichever occurs first.

- CONDITIONS:
1. Power Levers - Set.
 2. Propeller Control Levers - 1700 RPM
 3. Landing Gear - Up.
 4. Wing Flaps - Up.
 5. Cowl Flaps - As required.
 6. Inertial Separators - Normal.
 7. Heater - As required.

| | PRESSURE ALTITUDE - FEET | OAT °C | IOAT °C | TORQUE - FT-LBS | FUEL FLOW PER ENGINE - LB/HR | TOTAL FUEL FLOW - LB/HR | 7300 POUNDS | | 8300 POUNDS | | 9360 POUNDS | |
|--------------|--------------------------------|-----------|------------|--------------------|---------------------------------------|----------------------------------|----------------|------|----------------|------|----------------|------|
| | | | | | | | KIAS | KTAS | KIAS | KTAS | KIAS | KTAS |
| ISA +10°C | Sea Level | 25 | 30 | 1477 | 336 | 672 | 209 | 214 | 208 | 213 | 207 | 212 |
| | 2000 | 21 | 26 | 1477 | 327 | 654 | 207 | 218 | 206 | 217 | 205 | 216 |
| | 4000 | 17 | 22 | 1477 | 318 | 636 | 205 | 222 | 204 | 221 | 203 | 220 |
| | 6000 | 13 | 18 | 1477 | 311 | 622 | 203 | 227 | 202 | 226 | 200 | 224 |
| | 8000 | 9 | 15 | 1477 | 306 | 612 | 201 | 231 | 200 | 230 | 198 | 228 |
| | 10,000 | 5 | 11 | 1477 | 303 | 606 | 199 | 236 | 197 | 234 | 196 | 232 |
| | 12,000 | 1 | 7 | 1477 | 300 | 600 | 196 | 240 | 195 | 239 | 193 | 237 |
| | 14,000 | -3 | 3 | 1398 | 283 | 566 | 190 | 240 | 189 | 238 | 187 | 236 |
| | 16,000 | -7 | -1 | 1320 | 267 | 534 | 184 | 240 | 182 | 238 | 180 | 235 |
| | 18,000 | -11 | -5 | 1240 | 250 | 500 | 178 | 239 | 175 | 237 | 173 | 233 |
| | 20,000 | -15 | -9 | 1159 | 233 | 466 | 171 | 238 | 168 | 235 | 165 | 231 |
| | 22,000 | -19 | -13 | 1080 | 218 | 436 | 164 | 237 | 161 | 233 | 157 | 228 |
| | 24,000 | -23 | -17 | 1006 | 203 | 406 | 157 | 235 | 154 | 230 | 149 | 224 |
| | 26,000 | -27 | -21 | 935 | 190 | 380 | 150 | 232 | 146 | 226 | 140 | 218 |
| | 28,000 | -31 | -26 | 865 | 177 | 354 | 142 | 229 | 138 | 222 | 130 | 210 |
| | 30,000 | -34 | -30 | 797 | 164 | 328 | 135 | 225 | 129 | 215 | 117 | 197 |

Figure 5-26 (Sheet 5 of 8)
MAXIMUM CRUISE POWER
(1700 RPM)

CONDITIONS:

1. Power Levers - Set.
2. Propeller Control Levers - 1700 RPM
3. Landing Gear - Up.
4. Wing Flaps - Up.
5. Cowl Flaps - As required.
6. Inertial Separators - Normal.
7. Heater - As required.

NOTE:

1. Do not exceed Maximum Cruise Power Table values or 695 degrees Celsius ITT, whichever occurs first.

| ISA +20°C | PRESSURE ALTITUDE - FEET | OAT °C | IOAT °C | TORQUE- FT-LBS | FUEL FLOW PER ENGINE - LB/HR | TOTAL FUEL FLOW - LB/HR | 7300 POUNDS | | 8300 POUNDS | | 9360 POUNDS | |
|--------------|--------------------------------|-----------|------------|-------------------|---------------------------------------|----------------------------------|----------------|------|----------------|------|----------------|------|
| | | | | | | | KIAS | KTAS | KIAS | KTAS | KIAS | KTAS |
| Sea Level | 2000 | 35 | 40 | 1477 | 339 | 678 | 208 | 216 | 207 | 215 | 205 | 214 |
| | 4000 | 31 | 36 | 1477 | 330 | 660 | 206 | 220 | 205 | 219 | 203 | 218 |
| | 6000 | 27 | 32 | 1477 | 321 | 642 | 204 | 225 | 203 | 224 | 201 | 222 |
| | 8000 | 23 | 28 | 1477 | 314 | 628 | 202 | 229 | 201 | 228 | 199 | 226 |
| | | 19 | 25 | 1477 | 309 | 618 | 200 | 234 | 198 | 232 | 197 | 230 |
| | 10,000 | 15 | 21 | 1438 | 298 | 596 | 195 | 236 | 194 | 234 | 192 | 232 |
| | 12,000 | 11 | 17 | 1359 | 281 | 562 | 189 | 236 | 188 | 234 | 185 | 231 |
| 14,000 | 7 | 13 | 1286 | 265 | 530 | 183 | 236 | 181 | 234 | 179 | 231 | |
| 16,000 | 3 | 9 | 1214 | 249 | 498 | 177 | 236 | 175 | 233 | 172 | 229 | |
| 18,000 | -1 | 5 | 1140 | 234 | 468 | 171 | 235 | 168 | 232 | 165 | 227 | |
| 20,000 | -5 | 1 | 1070 | 219 | 438 | 164 | 234 | 161 | 230 | 158 | 225 | |
| 22,000 | -9 | -3 | 1003 | 205 | 410 | 158 | 232 | 154 | 228 | 150 | 222 | |
| 24,000 | -13 | -7 | 939 | 192 | 384 | 151 | 231 | 147 | 225 | 142 | 217 | |
| 26,000 | -17 | -12 | 872 | 179 | 358 | 144 | 228 | 139 | 221 | 133 | 211 | |
| 28,000 | -21 | -16 | 805 | 166 | 332 | 136 | 224 | 131 | 215 | 121 | 199 | |
| 30,000 | -24 | -20 | 740 | 154 | 308 | 128 | 219 | 121 | 206 | 111 | 188 | |

Figure 5-26 (Sheet 6 of 8)
MAXIMUM CRUISE POWER
(1700 RPM)

NOTE: Do not exceed Maximum Cruise Power Table values or 65 degrees Celsius ITT, whichever occurs first.

- CONDITIONS:
1. Power Levers - Set.
 2. Propeller Control Levers - 1700 RPM
 3. Landing Gear - Up.
 4. Wing Flaps - Up.
 5. Cowl Flaps - As required.
 6. Inertial Separators - Normal.
 7. Heater - As required.

| | PRESSURE ALTITUDE - FEET | OAT °C | IOAT °C | TORQUE- FT-LBS | FUEL FLOW PER ENGINE - LB/HR | TOTAL FUEL FLOW - LB/HR | 7300 POUNDS | | 8300 POUNDS | | 9360 POUNDS | |
|-----------|--------------------------|--------|---------|----------------|------------------------------|-------------------------|-------------|------|-------------|------|-------------|------|
| | | | | | | | KIAS | KTAS | KIAS | KTAS | KIAS | KTAS |
| ISA +30°C | Sea Level | 45 | 50 | 1477 | 342 | 684 | 207 | 218 | 206 | 217 | 204 | 216 |
| | 2000 | 41 | 46 | 1477 | 332 | 664 | 205 | 223 | 204 | 222 | 202 | 220 |
| | 4000 | 37 | 42 | 1477 | 324 | 648 | 203 | 227 | 201 | 226 | 200 | 224 |
| | 6000 | 33 | 38 | 1455 | 313 | 626 | 199 | 230 | 198 | 229 | 196 | 227 |
| | 8000 | 29 | 34 | 1387 | 296 | 592 | 194 | 231 | 192 | 229 | 190 | 227 |
| | 10,000 | 25 | 30 | 1311 | 278 | 556 | 188 | 231 | 186 | 229 | 184 | 226 |
| | 12,000 | 21 | 26 | 1239 | 261 | 522 | 182 | 231 | 180 | 228 | 177 | 225 |
| | 14,000 | 17 | 22 | 1172 | 247 | 494 | 176 | 230 | 173 | 228 | 171 | 224 |
| | 16,000 | 13 | 18 | 1108 | 232 | 464 | 170 | 230 | 167 | 227 | 164 | 223 |
| | 18,000 | 9 | 14 | 1042 | 218 | 436 | 163 | 229 | 161 | 225 | 157 | 220 |
| | 20,000 | 5 | 10 | 979 | 204 | 408 | 157 | 228 | 154 | 224 | 149 | 217 |
| | 22,000 | 1 | 6 | 918 | 191 | 382 | 151 | 226 | 147 | 221 | 141 | 213 |
| 24,000 | -3 | 2 | 859 | 179 | 358 | 144 | 224 | 139 | 218 | 133 | 207 | |
| 26,000 | -7 | -2 | 800 | 167 | 334 | 137 | 221 | 131 | 213 | 122 | 198 | |
| 28,000 | -11 | -6 | 741 | 156 | 312 | 130 | 217 | 122 | 206 | --- | --- | |
| 30,000 | -14 | -10 | 695 | 146 | 292 | 121 | 212 | --- | --- | --- | --- | |

Figure 5-26 (Sheet 7 of 8)
MAXIMUM CRUISE POWER
(1700 RPM)

CONDITIONS:

1. Power Levers - Set.
2. Propeller Control Levers - 1700 RPM
3. Landing Gear - Up.
4. Wing Flaps - Up.
5. Cowl Flaps - As required..
6. Inertial Separators - Normal.
7. Heater - As required.

NOTE:

1. Do not exceed Maximum Cruise Power Table values or 695 degrees Celsius ITT, whichever occurs first.

| | PRESSURE ALTITUDE - FEET | OAT °C | IOAT °C | TORQUE- FT-LBS | FUEL FLOW PER ENGINE - LB/HR | TOTAL FUEL FLOW - LB/HR | 7300 POUNDS | | | 8300 POUNDS | | | 9360 POUNDS | | | |
|-----------|--------------------------|--------|---------|----------------|------------------------------|-------------------------|-------------|------|------|-------------|------|------|-------------|------|------|-----|
| | | | | | | | KIAS | KTAS | KTAS | KIAS | KTAS | KTAS | KIAS | KTAS | KTAS | |
| ISA +37°C | Sea Level | 52 | 57 | 1460 | 340 | 680 | 205 | 219 | 204 | 218 | 202 | 216 | 202 | 218 | 202 | 216 |
| | 2000 | 48 | 53 | 1427 | 326 | 652 | 201 | 222 | 200 | 220 | 198 | 218 | 198 | 218 | 198 | 218 |
| | 4000 | 44 | 49 | 1391 | 312 | 624 | 197 | 224 | 196 | 222 | 194 | 220 | 194 | 220 | 194 | 220 |
| | 6000 | 40 | 45 | 1350 | 297 | 594 | 193 | 226 | 191 | 224 | 190 | 222 | 190 | 222 | 190 | 222 |
| | 8000 | 36 | 41 | 1293 | 282 | 564 | 186 | 227 | 186 | 225 | 184 | 222 | 184 | 222 | 184 | 222 |
| | 10,000 | 32 | 37 | 1225 | 265 | 530 | 182 | 227 | 180 | 224 | 178 | 221 | 178 | 221 | 178 | 221 |
| | 12,000 | 28 | 33 | 1159 | 250 | 500 | 176 | 226 | 174 | 224 | 171 | 220 | 171 | 220 | 171 | 220 |
| | 14,000 | 24 | 29 | 1097 | 235 | 470 | 170 | 226 | 168 | 223 | 165 | 219 | 165 | 219 | 165 | 219 |
| | 16,000 | 20 | 25 | 1035 | 221 | 442 | 164 | 226 | 162 | 222 | 158 | 217 | 158 | 217 | 158 | 217 |
| | 18,000 | 16 | 21 | 973 | 207 | 414 | 158 | 225 | 155 | 220 | 151 | 214 | 151 | 214 | 151 | 214 |
| 20,000 | 12 | 17 | 914 | 194 | 388 | 152 | 223 | 148 | 218 | 143 | 210 | 143 | 210 | 143 | 210 | |
| 22,000 | 8 | 13 | 857 | 182 | 364 | 145 | 221 | 141 | 215 | 135 | 206 | 135 | 206 | 135 | 206 | |
| 24,000 | 4 | 9 | 803 | 170 | 340 | 139 | 219 | 133 | 211 | 125 | 198 | 125 | 198 | 125 | 198 | |
| 26,000 | 0 | 5 | 747 | 159 | 318 | 132 | 216 | 125 | 205 | 114 | 195 | 114 | 195 | 114 | 195 | |
| 28,000 | -4 | 0 | 690 | 148 | 296 | 124 | 211 | 114 | 195 | 114 | 195 | 114 | 195 | 114 | 195 | |
| 30,000 | -7 | -3 | 649 | 139 | 278 | 115 | 204 | 115 | 204 | 115 | 204 | 115 | 204 | 115 | 204 | |

Figure 5-26 (Sheet 8 of 8)
MAXIMUM CRUISE POWER
(1700 RPM)

CONDITIONS:

1. Power Levers - Set.
2. Propeller Control Levers - 1600 RPM
3. Landing Gear - Up.
4. Wing Flaps - Up.
5. Cowl Flaps - As required.
6. Inertial Separators - Normal.
7. Heater - As required.

NOTE:

1. Do not exceed Maximum Cruise Power Table values or 695 degrees Celsius ITT, whichever occurs first.

| | PRESSURE ALTITUDE - FEET | OAT °C | IOAT °C | TORQUE- FT-LBS | FUEL FLOW PER ENGINE - LB/HR | TOTAL FUEL FLOW - LB/HR | 7300 POUNDS | | 8300 POUNDS | | 9360 POUNDS | |
|--------------|--------------------------|--------|---------|----------------|------------------------------|-------------------------|-------------|------|-------------|------|-------------|------|
| | | | | | | | KIAS | KTAS | KIAS | KTAS | KIAS | KTAS |
| ISA -30°C | Sea Level | -15 | -11 | 1477 | 314 | 628 | 210 | 200 | 209 | 199 | 208 | 198 |
| | 2000 | -19 | -15 | 1477 | 306 | 612 | 208 | 204 | 207 | 203 | 206 | 201 |
| | 4000 | -23 | -19 | 1477 | 298 | 596 | 206 | 208 | 205 | 206 | 204 | 205 |
| | 6000 | -27 | -22 | 1477 | 291 | 582 | 203 | 212 | 203 | 210 | 202 | 209 |
| | 8000 | -31 | -26 | 1477 | 286 | 572 | 201 | 216 | 201 | 214 | 199 | 213 |
| | 10,000 | -35 | -30 | 1477 | 283 | 566 | 200 | 220 | 199 | 218 | 197 | 217 |
| | 12,000 | -39 | -34 | 1477 | 280 | 560 | 198 | 224 | 197 | 222 | 195 | 221 |
| 14,000 | -43 | -38 | 1477 | 278 | 555 | 196 | 228 | 194 | 226 | 192 | 225 | |
| 16,000 | -47 | -41 | 1477 | 278 | 556 | 193 | 232 | 192 | 231 | 190 | 228 | |
| 18,000 | -51 | -45 | 1477 | 278 | 556 | 191 | 237 | 189 | 235 | 188 | 233 | |

EXAMPLE:

- Pressure Altitude - 10,000 Feet.
 - Outside Air Temperature - -15 Degrees Celsius (ISA - 10 Degrees Celsius).
 - Weight - 9000 Pounds.
-
- Airspeed (Approximation Method) - 222 KTAS (194 KIAS).
 - Fuel Flow (Approximation Method) - 516 pounds per hour total (288 pounds per hour per engine).

Figure 5-27 (Sheet 1 of 8)
MAXIMUM CRUISE POWER
(1600 RPM)

CONDITIONS:

1. Power Levers - Set.
2. Propeller Control Levers - 1600 RPM
3. Landing Gear - Up.
4. Wing Flaps - Up.
5. Cowl Flaps - As required.
6. Inertial Separators - Normal.
7. Heater - As required.

NOTE:

1. Do not exceed Maximum Cruise Power. Table values or 695 degrees Celsius ITT, whichever occurs first.

| | PRESSURE ALTITUDE - FEET | OAT °C | IOAT °C | TORQUE- FT-LBS | FUEL FLOW PER ENGINE - LB/HR | TOTAL FUEL FLOW - LB/HR | 7300 POUNDS | | 8300 POUNDS | | 9360 POUNDS | |
|--|--------------------------|--------|---------|----------------|------------------------------|-------------------------|-------------|-----------|-------------|------|-------------|------|
| | | | | | | | KIAS | KTAS | KIAS | KTAS | KIAS | KTAS |
| | | | | | | | ISA -20°C | Sea Level | -5 | -1 | 1477 | 317 |
| | 2000 | -9 | -5 | 1477 | 309 | 618 | 207 | 206 | 205 | 205 | 204 | 204 |
| | 4000 | -13 | -9 | 1477 | 300 | 600 | 205 | 210 | 203 | 209 | 202 | 207 |
| | 6000 | -17 | -12 | 1477 | 294 | 588 | 203 | 214 | 201 | 213 | 200 | 211 |
| | 8000 | -21 | -16 | 1477 | 289 | 578 | 201 | 218 | 199 | 217 | 198 | 215 |
| | 10,000 | -25 | -20 | 1477 | 285 | 570 | 198 | 222 | 197 | 221 | 196 | 219 |
| | 12,000 | -29 | -24 | 1477 | 283 | 566 | 196 | 227 | 195 | 225 | 193 | 223 |
| | 14,000 | -33 | -27 | 1477 | 281 | 562 | 194 | 231 | 192 | 228 | 191 | 227 |
| | 16,000 | -37 | -31 | 1477 | 280 | 560 | 192 | 235 | 190 | 233 | 188 | 231 |
| | 18,000 | -41 | -35 | 1477 | 280 | 560 | 189 | 240 | 188 | 238 | 186 | 235 |
| | 20,000 | -45 | -39 | 1455 | 275 | 550 | 186 | 243 | 184 | 241 | 182 | 238 |
| | 22,000 | -49 | -43 | 1358 | 256 | 512 | 179 | 242 | 177 | 239 | 174 | 235 |
| | 24,000 | -53 | -47 | 1265 | 239 | 478 | 172 | 240 | 169 | 237 | 166 | 233 |

**Figure 5-27 (Sheet 2 of 8)
MAXIMUM CRUISE POWER
(1600 RPM)**

CONDITIONS:

1. Power Levers - Set.
2. Propeller Control Levers - 1600 RPM
3. Landing Gear - Up.
4. Wing Flaps - Up.
5. Cowl Flaps - As required.
6. Inertial Separators - Normal.
7. Heater - As required.

NOTE:

1. Do not exceed Maximum Cruise Power Table values or 695 degrees Celsius ITT, whichever occurs first.

| | PRESSURE ALTITUDE - FEET | OAT °C | IOAT °C | TORQUE- FT-LBS | FUEL FLOW PER ENGINE - LB/HR | TOTAL FUEL FLOW - LB/HR | 7300 POUNDS | | 8300 POUNDS | | 9360 POUNDS | |
|--------------|--------------------------|--------|---------|----------------|------------------------------|-------------------------|-------------|------|-------------|------|-------------|------|
| | | | | | | | KIAS | KTAS | KIAS | KTAS | KIAS | KTAS |
| ISA -10°C | Sea Level | 5 | 9 | 1477 | 321 | 642 | 207 | 205 | 206 | 204 | 205 | 202 |
| | 2000 | 1 | 5 | 1477 | 312 | 624 | 205 | 209 | 204 | 208 | 203 | 206 |
| | 4000 | -3 | 2 | 1477 | 303 | 606 | 203 | 213 | 202 | 211 | 201 | 210 |
| | 6000 | -7 | -2 | 1477 | 297 | 594 | 201 | 217 | 200 | 215 | 198 | 214 |
| | 8000 | -11 | -6 | 1477 | 291 | 582 | 199 | 221 | 198 | 219 | 196 | 218 |
| | 10,000 | -15 | -10 | 1477 | 288 | 576 | 197 | 225 | 196 | 224 | 194 | 222 |
| | 12,000 | -19 | -14 | 1477 | 285 | 570 | 194 | 229 | 193 | 228 | 191 | 226 |
| | 14,000 | -23 | -17 | 1477 | 283 | 566 | 192 | 234 | 191 | 232 | 189 | 230 |
| | 16,000 | -27 | -21 | 1477 | 282 | 564 | 190 | 238 | 188 | 236 | 186 | 234 |
| | 18,000 | -31 | -25 | 1464 | 279 | 558 | 187 | 242 | 185 | 240 | 183 | 237 |
| | 20,000 | -35 | -29 | 1369 | 261 | 522 | 180 | 241 | 178 | 238 | 175 | 235 |
| | 22,000 | -39 | -33 | 1277 | 244 | 488 | 173 | 239 | 171 | 236 | 168 | 232 |
| | 24,000 | -43 | -37 | 1191 | 227 | 454 | 166 | 234 | 163 | 234 | 160 | 229 |
| | 26,000 | -47 | -41 | 1107 | 211 | 422 | 159 | 236 | 156 | 231 | 151 | 225 |
| | 28,000 | -51 | -45 | 1025 | 197 | 394 | 152 | 233 | 148 | 227 | 142 | 219 |
| | 30,000 | -54 | -49 | 948 | 183 | 366 | 144 | 230 | 140 | 223 | 132 | 212 |

Figure 5-27 (Sheet 3 of 8)
MAXIMUM CRUISE POWER
(1600 RPM)

CONDITIONS:

1. Power Levers - Set.
2. Propeller Control Levers - 1600 RPM
3. Landing Gear - Up.
4. Wing Flaps - Up.
5. Cowl Flaps - As required.
6. Inertial Separators - Normal.
7. Heater - As required.

NOTE:

1. Do not exceed Maximum Cruise Power Table values or 695 degrees Celsius ITT, whichever occurs first.

| | PRESSURE ALTITUDE - FEET | OAT °C | IOAT °C | TORQUE - FT-LBS | FUEL FLOW PER ENGINE - LB/HR | TOTAL FUEL FLOW - LB/HR | 7300 POUNDS | | 8300 POUNDS | | 9360 POUNDS | |
|--------|--------------------------|--------|---------|-----------------|------------------------------|-------------------------|-------------|------|-------------|------|-------------|------|
| | | | | | | | KIAS | KTAS | KIAS | KTAS | KIAS | KTAS |
| | | | | | | | | | | | | |
| ISA | Sea Level | 15 | 19 | 1477 | 323 | 646 | 206 | 207 | 205 | 206 | 203 | 205 |
| | 2000 | 11 | 16 | 1477 | 314 | 628 | 204 | 211 | 203 | 210 | 201 | 208 |
| | 4000 | 7 | 12 | 1477 | 306 | 612 | 202 | 215 | 201 | 214 | 199 | 212 |
| | 6000 | 3 | 8 | 1477 | 298 | 598 | 200 | 219 | 198 | 218 | 197 | 216 |
| | 8000 | -1 | 4 | 1477 | 294 | 588 | 198 | 223 | 196 | 222 | 194 | 220 |
| | 10,000 | -5 | 0 | 1477 | 291 | 582 | 195 | 228 | 194 | 226 | 192 | 224 |
| | 12,000 | -9 | -3 | 1477 | 288 | 576 | 193 | 232 | 191 | 230 | 190 | 228 |
| | 14,000 | -13 | -7 | 1477 | 285 | 570 | 191 | 236 | 189 | 234 | 187 | 232 |
| | 16,000 | -17 | -11 | 1469 | 282 | 564 | 188 | 240 | 186 | 238 | 184 | 235 |
| | 18,000 | -21 | -15 | 1374 | 264 | 528 | 181 | 239 | 179 | 237 | 176 | 233 |
| | 20,000 | -25 | -19 | 1284 | 247 | 494 | 174 | 238 | 172 | 235 | 169 | 231 |
| | 22,000 | -29 | -23 | 1198 | 231 | 482 | 167 | 237 | 165 | 233 | 161 | 228 |
| 24,000 | -33 | -27 | 1116 | 215 | 430 | 160 | 237 | 157 | 230 | 153 | 224 | |
| 26,000 | -37 | -31 | 1037 | 200 | 400 | 153 | 232 | 150 | 227 | 144 | 220 | |
| 28,000 | -41 | -35 | 960 | 187 | 374 | 146 | 229 | 141 | 223 | 135 | 213 | |
| 30,000 | -44 | -40 | 887 | 173 | 346 | 138 | 226 | 133 | 217 | 124 | 203 | |

Figure 5-27 (Sheet 4 of 8)
MAXIMUM CRUISE POWER
(1600 RPM)

NOTE: Do not exceed Maximum Cruise Power
1. Table values or 695 degrees Celsius (171,
whichever occurs first.

- CONDITIONS:
1. Power Levers - Set.
 2. Propeller Control Levers - 1600 RPM
 3. Landing Gear - Up.
 4. Wing Flaps - Up.
 5. Cowl Flaps - As required.
 6. Inertial Separators - Normal.
 7. Heater - As required.

| | PRESSURE ALTITUDE - FEET | OAT °C | IOAT °C | TORQUE - FT-LBS | FUEL FLOW PER ENGINE - LB/HR | TOTAL FUEL FLOW - LB/HR | 7300 POUNDS | | 8300 POUNDS | | 9360 POUNDS | |
|--------------|--------------------------------|-----------|------------|--------------------|---------------------------------------|----------------------------------|----------------|------|----------------|------|----------------|------|
| | | | | | | | KIAS | KTAS | KIAS | KTAS | KIAS | KTAS |
| ISA +10°C | Sea Level | 25 | 29 | 1477 | 326 | 652 | 204 | 209 | 203 | 208 | 202 | 207 |
| | 2000 | 21 | 26 | 1477 | 317 | 634 | 203 | 213 | 201 | 212 | 200 | 211 |
| | 4000 | 17 | 22 | 1477 | 309 | 618 | 200 | 217 | 199 | 216 | 198 | 214 |
| | 6000 | 13 | 18 | 1477 | 302 | 604 | 198 | 222 | 197 | 220 | 195 | 218 |
| | 8000 | 9 | 14 | 1477 | 296 | 592 | 196 | 226 | 195 | 224 | 193 | 222 |
| | 10,000 | 5 | 11 | 1477 | 293 | 586 | 194 | 230 | 192 | 228 | 190 | 226 |
| | 12,000 | 1 | 7 | 1477 | 290 | 580 | 191 | 234 | 190 | 233 | 188 | 230 |
| | 14,000 | -3 | 3 | 1452 | 282 | 564 | 188 | 237 | 186 | 235 | 184 | 232 |
| | 16,000 | -7 | -1 | 1370 | 266 | 532 | 182 | 237 | 180 | 234 | 177 | 231 |
| | 18,000 | -11 | -5 | 1287 | 250 | 500 | 175 | 236 | 173 | 233 | 170 | 230 |
| | 20,000 | -15 | -9 | 1202 | 233 | 466 | 168 | 235 | 166 | 231 | 162 | 227 |
| | 22,000 | -19 | -13 | 1121 | 217 | 434 | 161 | 233 | 158 | 229 | 154 | 223 |
| | 24,000 | -23 | -17 | 1043 | 203 | 406 | 154 | 231 | 151 | 226 | 146 | 219 |
| | 26,000 | -27 | -21 | 969 | 189 | 378 | 147 | 229 | 143 | 222 | 137 | 213 |
| | 28,000 | -31 | -26 | 896 | 176 | 352 | 140 | 225 | 135 | 217 | 126 | 204 |
| | 30,000 | -34 | -30 | 825 | 164 | 328 | 132 | 221 | 125 | 210 | 111 | 187 |

Figure 5-27 (Sheet 5 of 8)
MAXIMUM CRUISE POWER
(1600 RPM)

CONDITIONS:

1. Power Levers - Set.
2. Propeller Control Levers - 1600 RPM
3. Landing Gear - Up.
4. Wing Flaps - Up.
5. Cowl Flaps - As required.
6. Inertial Separators - Normal.
7. Heater - As required.

NOTE:

1. Do not exceed Maximum Cruise Power Table values or 695 degrees Celsius ITT, whichever occurs first.

| | PRESSURE ALTITUDE - FEET | OAT °C | IOAT °C | TORQUE- FT-LBS | FUEL FLOW PER ENGINE - LB/HR | TOTAL FUEL FLOW - LB/HR | 7300 POUNDS | | 8300 POUNDS | | 9360 POUNDS | |
|-----------|--------------------------|--------|---------|----------------|------------------------------|-------------------------|-------------|------|-------------|------|-------------|------|
| | | | | | | | KIAS | KTAS | KIAS | KTAS | KIAS | KTAS |
| ISA +20°C | Sea Level | 35 | 40 | 1477 | 329 | 658 | 203 | 212 | 202 | 210 | 201 | 209 |
| | 2000 | 31 | 36 | 1477 | 321 | 642 | 201 | 216 | 200 | 214 | 199 | 213 |
| | 4000 | 27 | 32 | 1477 | 312 | 624 | 199 | 220 | 198 | 218 | 196 | 217 |
| | 6000 | 23 | 28 | 1477 | 305 | 610 | 197 | 224 | 196 | 222 | 194 | 221 |
| | 8000 | 19 | 24 | 1477 | 299 | 598 | 195 | 228 | 193 | 226 | 191 | 224 |
| | 10,000 | 15 | 21 | 1477 | 295 | 590 | 192 | 232 | 191 | 231 | 189 | 229 |
| | 12,000 | 11 | 17 | 1411 | 280 | 560 | 187 | 233 | 185 | 231 | 183 | 228 |
| | 14,000 | 7 | 13 | 1334 | 264 | 528 | 181 | 233 | 179 | 230 | 176 | 227 |
| | 16,000 | 3 | 9 | 1259 | 249 | 498 | 174 | 232 | 172 | 230 | 169 | 226 |
| | 18,000 | -1 | 5 | 1183 | 233 | 466 | 168 | 231 | 166 | 228 | 162 | 224 |
| | 20,000 | -5 | 1 | 1110 | 219 | 438 | 162 | 230 | 159 | 226 | 155 | 221 |
| | 22,000 | -9 | -4 | 1040 | 205 | 410 | 155 | 229 | 152 | 224 | 147 | 217 |
| | 24,000 | -13 | -8 | 973 | 192 | 384 | 149 | 227 | 145 | 221 | 139 | 213 |
| | 26,000 | -17 | -12 | 903 | 178 | 356 | 141 | 224 | 136 | 217 | 129 | 205 |
| | 28,000 | -21 | -16 | 834 | 166 | 332 | 134 | 220 | 127 | 210 | 116 | 191 |
| | 30,000 | -24 | -20 | 766 | 153 | 306 | 125 | 215 | 117 | 200 | --- | --- |

Figure 5-27 (Sheet 6 of 8)
MAXIMUM CRUISE POWER
(1600 RPM)

CONDITIONS:

1. Power Levers - Set.
2. Propeller Control Levers - 1600 RPM
3. Landing Gear - Up.
4. Wing Flaps - Up.
5. Cowl Flaps - As required.
6. Inertial Separators - Normal.
7. Heater - As required.

NOTE:

1. Do not exceed Maximum Cruise Power Table values or 695 degrees Celsius ITT, whichever occurs first.

| | PRESSURE ALTITUDE - FEET | OAT °C | IOAT °C | TORQUE- FT-LBS | FUEL FLOW PER ENGINE - LB/HR | TOTAL FUEL FLOW - LB/HR | 7300 POUNDS | | 8300 POUNDS | | 9360 POUNDS | |
|--------------|--------------------------|--------|---------|----------------|------------------------------|-------------------------|-------------|------|-------------|------|-------------|------|
| | | | | | | | KIAS | KTAS | KIAS | KTAS | KIAS | KTAS |
| ISA +30°C | Sea Level | 45 | 50 | 1477 | 332 | 664 | 202 | 214 | 201 | 212 | 199 | 211 |
| | 2000 | 41 | 46 | 1477 | 324 | 648 | 200 | 218 | 199 | 216 | 197 | 215 |
| | 4000 | 37 | 42 | 1477 | 315 | 630 | 198 | 222 | 197 | 220 | 195 | 219 |
| | 6000 | 33 | 38 | 1477 | 308 | 618 | 196 | 226 | 194 | 225 | 192 | 223 |
| | 8000 | 29 | 34 | 1440 | 295 | 590 | 191 | 228 | 190 | 226 | 188 | 224 |
| | 10,000 | 25 | 30 | 1360 | 278 | 556 | 185 | 228 | 184 | 226 | 181 | 223 |
| | 12,000 | 21 | 26 | 1286 | 261 | 522 | 179 | 228 | 177 | 225 | 175 | 222 |
| | 14,000 | 17 | 22 | 1216 | 246 | 492 | 173 | 227 | 171 | 225 | 168 | 221 |
| | 16,000 | 13 | 18 | 1149 | 232 | 464 | 167 | 227 | 165 | 224 | 161 | 219 |
| | 18,000 | 9 | 14 | 1081 | 217 | 434 | 161 | 226 | 158 | 222 | 154 | 217 |
| | 20,000 | 5 | 10 | 1015 | 204 | 408 | 155 | 225 | 151 | 220 | 147 | 213 |
| | 22,000 | 1 | 6 | 951 | 191 | 382 | 148 | 223 | 144 | 217 | 138 | 209 |
| 24,000 | -3 | 2 | 890 | 178 | 356 | 141 | 221 | 137 | 214 | 129 | 202 | |
| 26,000 | -7 | -2 | 828 | 167 | 334 | 134 | 218 | 128 | 208 | 118 | 191 | |
| 28,000 | -11 | -6 | 767 | 156 | 312 | 127 | 213 | 119 | 200 | --- | --- | |
| 30,000 | -14 | -10 | 720 | 146 | 292 | 118 | 207 | --- | --- | --- | --- | |

Figure 5-27 (Sheet 7 of 8)
MAXIMUM CRUISE POWER
(1600 RPM)

CONDITIONS:

1. Power Levers - Set.
2. Propeller Control Levers - 1600 RPM
3. Landing Gear - Up.
4. Wing Flaps - Up.
5. Cowl Flaps - As required.
6. Inertial Separators - Normal.
7. Heater - As required.

NOTE:

1. Do not exceed Maximum Cruise Power Table values or 695 degrees Celsius ITT, whichever occurs first.

| ISA +37°C | PRESSURE ALTITUDE - FEET | OAT °C | IOAT °C | TORQUE- FT-LBS | FUEL FLOW PER ENGINE - LB/HR | TOTAL FUEL FLOW - LB/HR | 7300 POUNDS | | 8300 POUNDS | | 9360 POUNDS | |
|--------------|--------------------------------|-----------|------------|-------------------|---------------------------------------|----------------------------------|----------------|------|----------------|------|----------------|------|
| | | | | | | | KIAS | KTAS | KIAS | KTAS | KIAS | KTAS |
| | Sea Level | 52 | 57 | 1477 | 334 | 668 | 201 | 215 | 200 | 214 | 199 | 212 |
| | 2000 | 48 | 53 | 1477 | 325 | 650 | 199 | 219 | 198 | 218 | 196 | 216 |
| | 4000 | 44 | 49 | 1444 | 311 | 622 | 195 | 222 | 194 | 220 | 192 | 218 |
| | 6000 | 40 | 45 | 1400 | 297 | 594 | 191 | 223 | 189 | 222 | 187 | 219 |
| | 8000 | 36 | 41 | 1341 | 281 | 562 | 186 | 224 | 184 | 222 | 182 | 219 |
| | 10,000 | 32 | 37 | 1271 | 265 | 530 | 180 | 224 | 178 | 222 | 175 | 219 |
| | 12,000 | 28 | 33 | 1202 | 250 | 500 | 174 | 224 | 172 | 221 | 169 | 217 |
| | 14,000 | 24 | 29 | 1137 | 235 | 470 | 168 | 223 | 166 | 220 | 162 | 216 |
| | 16,000 | 20 | 25 | 1074 | 221 | 442 | 162 | 223 | 159 | 219 | 155 | 214 |
| | 18,000 | 16 | 21 | 1009 | 207 | 414 | 156 | 222 | 153 | 217 | 148 | 211 |
| | 20,000 | 12 | 17 | 947 | 194 | 388 | 149 | 220 | 146 | 215 | 140 | 207 |
| | 22,000 | 8 | 13 | 888 | 181 | 362 | 143 | 218 | 138 | 211 | 131 | 201 |
| | 24,000 | 4 | 9 | 831 | 170 | 340 | 136 | 216 | 131 | 207 | 121 | 192 |
| | 26,000 | 0 | 5 | 773 | 158 | 316 | 129 | 212 | 122 | 200 | 115 | 187 |
| | 28,000 | -4 | 1 | 726 | 149 | 298 | 121 | 207 | 115 | 197 | 110 | 182 |
| | 30,000 | -- | -- | -- | -- | -- | -- | -- | -- | -- | -- | -- |

Figure 5-27 (Sheet 8 of 8)
MAXIMUM CRUISE POWER
(1600 RPM)

CONDITIONS:

1. Power Levers - As Required To Obtain The Airspeed Shown.
2. Landing Gear - Up.
3. Wing Flaps - Up.
4. Cowl Flaps - As Required.
5. Inertial Separators - Normal.
6. Heater - As Required.

NOTE:

1. Where values are not presented, use Maximum Cruise Power 1900 RPM; refer to Figure 5-24.

| IS A -30°C | PRESSURE ALTITUDE - FEET | OAT °C | IDAT °C | 7300 POUNDS | | | | 8300 POUNDS | | | | 9360 POUNDS | | | |
|---------------|--------------------------------|-----------|------------|--|----------------------------------|------|------|--|----------------------------------|------|------|--|----------------------------------|------|------|
| | | | | FUEL FLOW PER ENGINE - LB/HR | FUEL FLOW TOTAL - LB/HR | KIAS | KTAS | FUEL FLOW PER ENGINE - LB/HR | FUEL FLOW TOTAL - LB/HR | KIAS | KTAS | FUEL FLOW PER ENGINE - LB/HR | FUEL FLOW TOTAL - LB/HR | KIAS | KTAS |
| | | | | -15 | 250 | 500 | 179 | 171 | 253 | 506 | 179 | 171 | 258 | 517 | 180 |
| -16 | 234 | 468 | 174 | 171 | 238 | 475 | 174 | 171 | 244 | 488 | 176 | 172 | | | |
| -20 | 218 | 436 | 168 | 170 | 223 | 446 | 169 | 171 | 231 | 462 | 172 | 173 | | | |
| -24 | 204 | 408 | 163 | 169 | 210 | 419 | 164 | 171 | 219 | 438 | 167 | 174 | | | |
| -28 | 192 | 384 | 158 | 169 | 199 | 397 | 160 | 171 | 207 | 413 | 162 | 174 | | | |
| -32 | 181 | 362 | 154 | 170 | 188 | 377 | 156 | 172 | 195 | 390 | 157 | 173 | | | |
| -36 | 171 | 342 | 149 | 170 | 178 | 355 | 151 | 172 | 186 | 373 | 153 | 174 | | | |
| -40 | 160 | 320 | 144 | 169 | 169 | 337 | 146 | 172 | 180 | 360 | 150 | 176 | | | |
| -44 | 151 | 302 | 139 | 169 | 161 | 321 | 142 | 172 | 177 | 353 | 150 | 181 | | | |
| -48 | 144 | 288 | 136 | 170 | 154 | 309 | 139 | 174 | 177 | 354 | 152 | 189 | | | |

EXAMPLE:

Pressure Altitude - 10,000 Feet.
Outside Air Temperature - -15 Degrees Celsius (ISA - 10 Degrees Celsius).
Weight - 9000 Pounds.

Airspeed (Approximation Method) - 181 KTAS (157 KIAS) Fuel Flow
Fuel Flow (Approximation Method) - 407 Pounds Per Hour Total (204 Pounds Per Hour Per Engine).

Figure 5-28 (Sheet 1 of 8)
MAXIMUM RANGE CRUISE PERFORMANCE
(1900 RPM)

CONDITIONS:

1. Power Levers - As Required To Obtain The Airspeed Shown.
2. Landing Gear - Up.
3. Wing Flaps - Up.
4. Cowli Flaps - As Required.
5. Inertial Separators - Normal.
6. Heater - As Required.

NOTE:

1. Where values are not presented, use Maximum Cruise Power 1900 RPM; refer to Figure 5-24.

| PRESSURE ALTITUDE- FEET | OAT °C | IOAT °C | 7300 POUNDS | | | | 8300 POUNDS | | | | 9360 POUNDS | | | |
|-------------------------|-----------|---------|-----------------------------|------------------------|------|------|-----------------------------|------------------------|------|------|-----------------------------|------------------------|------|------|
| | | | FUEL FLOW PER ENGINE- LB/HR | FUEL FLOW TOTAL- LB/HR | KIAS | KTAS | FUEL FLOW PER ENGINE- LB/HR | FUEL FLOW TOTAL- LB/HR | KIAS | KTAS | FUEL FLOW PER ENGINE- LB/HR | FUEL FLOW TOTAL- LB/HR | KIAS | KTAS |
| ISA -20°C | Sea Level | -5 | 250 | 500 | 177 | 172 | 254 | 508 | 177 | 172 | 262 | 524 | 180 | 175 |
| | | -9 | 234 | 468 | 171 | 171 | 239 | 477 | 172 | 172 | 248 | 496 | 175 | 177 |
| | | -13 | 219 | 438 | 166 | 171 | 225 | 451 | 168 | 173 | 234 | 467 | 171 | 176 |
| | | -17 | 206 | 412 | 162 | 172 | 213 | 426 | 164 | 174 | 221 | 442 | 166 | 176 |
| 10,000 | 20,000 | -21 | 193 | 396 | 157 | 171 | 202 | 404 | 160 | 175 | 209 | 418 | 161 | 176 |
| | | -25 | 183 | 366 | 153 | 172 | 190 | 380 | 154 | 174 | 199 | 397 | 156 | 176 |
| | | -29 | 173 | 346 | 149 | 173 | 180 | 360 | 150 | 174 | 192 | 384 | 154 | 179 |
| | | -33 | 163 | 326 | 144 | 173 | 172 | 343 | 146 | 175 | 190 | 379 | 155 | 186 |
| 16,000 | 22,000 | -37 | 154 | 308 | 139 | 172 | 165 | 331 | 143 | 177 | 187 | 374 | 155 | 191 |
| | | -41 | 147 | 294 | 136 | 174 | 162 | 325 | 143 | 182 | 182 | 363 | 153 | 195 |
| | | -45 | 141 | 282 | 132 | 175 | 162 | 324 | 145 | 191 | 174 | 347 | 148 | 195 |
| | | -49 | 139 | 278 | 132 | 180 | 157 | 314 | 141 | 193 | 167 | 334 | 143 | 195 |
| 18,000 | 24,000 | -53 | 137 | 274 | 132 | 186 | 150 | 301 | 137 | 193 | 163 | 325 | 139 | 196 |

Figure 5-28 (Sheet 2 of 8)
MAXIMUM RANGE CRUISE PERFORMANCE
(1900 RPM)

| CONDITIONS: | PRESSURE ALTITUDE- FEET | OAT °C | IOAT °C | 7300 POUNDS | | | | 8300 POUNDS | | | | 9360 POUNDS | | | |
|--------------|-------------------------|--------|---------|-----------------------------|------------------------|------|------|-----------------------------|------------------------|------|------|-----------------------------|------------------------|------|------|
| | | | | FUEL FLOW PER ENGINE- LB/HR | FUEL FLOW TOTAL- LB/HR | KIAS | KTAS | FUEL FLOW PER ENGINE- LB/HR | FUEL FLOW TOTAL- LB/HR | KIAS | KTAS | FUEL FLOW PER ENGINE- LB/HR | FUEL FLOW TOTAL- LB/HR | KIAS | KTAS |
| ISA -10°C | Sea Level | 5 | 8 | 248 | 496 | 173 | 172 | 256 | 312 | 176 | 174 | 264 | 529 | 179 | 177 |
| | 2000 | 1 | 4 | 235 | 470 | 170 | 173 | 242 | 484 | 172 | 175 | 250 | 500 | 174 | 177 |
| | 4000 | -3 | 0 | 220 | 440 | 165 | 173 | 227 | 454 | 167 | 175 | 237 | 475 | 170 | 179 |
| | 6000 | -7 | -4 | 207 | 414 | 160 | 173 | 216 | 432 | 164 | 177 | 225 | 450 | 166 | 179 |
| | 8000 | -11 | -8 | 195 | 390 | 156 | 174 | 204 | 408 | 158 | 176 | 213 | 427 | 161 | 180 |
| | 10,000 | -15 | -12 | 185 | 370 | 151 | 174 | 193 | 386 | 154 | 177 | 204 | 407 | 157 | 181 |
| | 12,000 | -19 | -16 | 175 | 350 | 147 | 175 | 183 | 366 | 149 | 177 | 201 | 403 | 159 | 188 |
| | 14,000 | -23 | -20 | 165 | 330 | 143 | 175 | 175 | 350 | 146 | 179 | 198 | 396 | 159 | 194 |
| | 16,000 | -27 | -23 | 156 | 312 | 138 | 175 | 171 | 348 | 147 | 186 | 191 | 382 | 156 | 196 |
| | 18,000 | -31 | -27 | 151 | 302 | 136 | 178 | 174 | 342 | 147 | 192 | 183 | 367 | 151 | 197 |
| | 20,000 | -35 | -31 | 147 | 294 | 135 | 182 | 166 | 332 | 145 | 195 | 176 | 351 | 147 | 197 |
| | 22,000 | -39 | -35 | 146 | 292 | 136 | 189 | 159 | 318 | 141 | 196 | 168 | 336 | 141 | 197 |
| 24,000 | -43 | -39 | 143 | 286 | 134 | 194 | 151 | 302 | 135 | 195 | 164 | 328 | 138 | 199 | |
| 26,000 | -47 | -43 | 137 | 274 | 130 | 194 | 148 | 296 | 132 | 197 | 161 | 322 | 134 | 200 | |
| 28,000 | -51 | -47 | 133 | 266 | 126 | 196 | 145 | 290 | 128 | 198 | 160 | 320 | 131 | 202 | |

NOTE:
1. Where values are not presented, use Maximum Cruise Power 1900 RPM; refer to Figure 5-24.

- CONDITIONS:
- Power Levers - As Required To Obtain The Airspeed Shown.
 - Landing Gear - Up.
 - Wing Flaps - Up.
 - Cowl Flaps - As Required.
 - Inertial Separators - Normal.
 - Heater - As Required.

Figure 5-28 (Sheet 3 of 8)
MAXIMUM RANGE CRUISE PERFORMANCE
(1900 RPM)

CONDITIONS:

1. Power Levers - As Required To Obtain The Airspeed Shown.
2. Landing Gear - Up.
3. Wing Flaps - Up.
4. Cowl Flaps - As Required.
5. Inertial Separators - Normal.
6. Heater - As Required.

NOTE:

1. Where values are not presented, use Maximum Cruise Power 1900 RPM; refer to Figure 5-24.

| PRESSURE ALTITUDE- FEET | OAT °C | IOAT °C | 7300 POUNDS | | | | 8300 POUNDS | | | | 9360 POUNDS | | | | | | | | |
|-------------------------|--------|---------|-----------------------------|------------------------|------|------|-----------------------------|------------------------|------|------|-----------------------------|------------------------|------|------|--|--|--|--|--|
| | | | FUEL FLOW PER ENGINE- LB/HR | FUEL FLOW TOTAL- LB/HR | KIAS | KTAS | FUEL FLOW PER ENGINE- LB/HR | FUEL FLOW TOTAL- LB/HR | KIAS | KTAS | FUEL FLOW PER ENGINE- LB/HR | FUEL FLOW TOTAL- LB/HR | KIAS | KTAS | | | | | |
| ISA | | | | | | | | | | | | | | | | | | | |
| Sea Level | 15 | 18 | 247 | 494 | 170 | 172 | 257 | 513 | 174 | 175 | 268 | 536 | 178 | 180 | | | | | |
| 2000 | 11 | 14 | 235 | 470 | 167 | 174 | 244 | 487 | 170 | 177 | 254 | 507 | 174 | 180 | | | | | |
| 4000 | 7 | 10 | 222 | 444 | 164 | 175 | 230 | 460 | 166 | 177 | 240 | 480 | 169 | 181 | | | | | |
| 6000 | 3 | 6 | 209 | 418 | 159 | 175 | 218 | 436 | 162 | 179 | 229 | 458 | 166 | 183 | | | | | |
| 8000 | -1 | 2 | 198 | 396 | 155 | 176 | 208 | 416 | 159 | 180 | 221 | 442 | 164 | 186 | | | | | |
| 10,000 | -5 | -2 | 187 | 374 | 151 | 177 | 198 | 397 | 155 | 181 | 216 | 431 | 163 | 191 | | | | | |
| 12,000 | -9 | -6 | 178 | 356 | 147 | 178 | 189 | 378 | 152 | 183 | 209 | 417 | 161 | 195 | | | | | |
| 14,000 | -13 | -9 | 168 | 336 | 143 | 178 | 184 | 368 | 151 | 188 | 202 | 405 | 159 | 198 | | | | | |
| 16,000 | -17 | -13 | 160 | 320 | 139 | 179 | 181 | 362 | 151 | 194 | 193 | 386 | 154 | 199 | | | | | |
| 18,000 | -21 | -17 | 158 | 310 | 139 | 186 | 174 | 348 | 148 | 196 | 185 | 369 | 150 | 199 | | | | | |
| 20,000 | -25 | -21 | 154 | 308 | 139 | 191 | 167 | 335 | 144 | 198 | 177 | 355 | 146 | 200 | | | | | |
| 22,000 | -29 | -25 | 150 | 300 | 137 | 195 | 160 | 320 | 139 | 198 | 170 | 340 | 140 | 200 | | | | | |
| 24,000 | -33 | -29 | 145 | 290 | 134 | 197 | 154 | 307 | 135 | 198 | 166 | 332 | 137 | 201 | | | | | |
| 26,000 | -37 | -33 | 138 | 276 | 129 | 197 | 149 | 299 | 131 | 199 | 165 | 329 | 134 | 204 | | | | | |
| 28,000 | -40 | -36 | 134 | 268 | 125 | 197 | 147 | 293 | 127 | 201 | 164 | 327 | 130 | 206 | | | | | |

Figure 5-28 (Sheet 4 of 8)
MAXIMUM RANGE CRUISE PERFORMANCE
(1900 RPM)

CONDITIONS:
 1. Power Levers - As Required To Obtain
 The Airspeed Shown.
 2. Landing Gear - Up.
 3. Wing Flaps - Up.
 4. Cowl Flaps - As Required.
 5. Inertial Separators - Normal.
 6. Heater - As Required.

NOTE:

1. Where values are not presented, use Maximum
 Cruise Power 1900 RPM; refer to Figure 5-24.

| PRESSURE ALTITUDE- FEET | OAT °C | IOAT °C | 7300 POUNDS | | | | 8300 POUNDS | | | | 9360 POUNDS | | | |
|-------------------------------|-----------|------------|---|---------------------------------|------|------|---|---------------------------------|------|------|---|---------------------------------|------|------|
| | | | FUEL FLOW PER ENGINE- LB/HR | FUEL FLOW TOTAL- LB/HR | KIAS | KTAS | FUEL FLOW PER ENGINE- LB/HR | FUEL FLOW TOTAL- LB/HR | KIAS | KTAS | FUEL FLOW PER ENGINE- LB/HR | FUEL FLOW TOTAL- LB/HR | KIAS | KTAS |
| | | | ISA +10°C | 25 | 28 | 245 | 490 | 167 | 171 | 256 | 512 | 171 | 176 | 271 |
| 2000 | 21 | 24 | 236 | 472 | 165 | 175 | 247 | 494 | 170 | 179 | 257 | 515 | 173 | 183 |
| 4000 | 17 | 20 | 224 | 448 | 167 | 177 | 233 | 466 | 165 | 190 | 246 | 491 | 170 | 185 |
| 6000 | 13 | 16 | 210 | 420 | 157 | 177 | 221 | 442 | 161 | 181 | 236 | 472 | 168 | 189 |
| 8000 | 9 | 12 | 199 | 398 | 154 | 178 | 211 | 422 | 159 | 183 | 230 | 461 | 168 | 194 |
| 10,000 | 5 | 9 | 190 | 380 | 151 | 180 | 203 | 406 | 156 | 186 | 221 | 441 | 164 | 196 |
| 12,000 | 1 | 5 | 181 | 362 | 147 | 181 | 196 | 392 | 155 | 190 | 213 | 425 | 162 | 199 |
| 14,000 | -3 | 1 | 172 | 344 | 143 | 182 | 190 | 380 | 153 | 194 | 204 | 407 | 158 | 200 |
| 16,000 | -7 | -3 | 168 | 336 | 143 | 188 | 184 | 368 | 151 | 198 | 194 | 388 | 153 | 201 |
| 18,000 | -11 | -7 | 165 | 330 | 143 | 194 | 177 | 354 | 147 | 199 | 186 | 372 | 148 | 201 |
| 20,000 | -15 | -11 | 159 | 318 | 140 | 197 | 169 | 338 | 143 | 200 | 179 | 357 | 144 | 202 |
| 22,000 | -19 | -15 | 152 | 304 | 137 | 198 | 162 | 324 | 138 | 201 | 172 | 343 | 139 | 202 |
| 24,000 | -23 | -19 | 146 | 292 | 133 | 200 | 154 | 308 | 133 | 200 | 169 | 337 | 136 | 204 |
| 26,000 | -27 | -23 | 139 | 278 | 127 | 199 | 151 | 302 | 130 | 202 | 167 | 333 | 132 | 206 |

Figure 5-28 (Sheet 5 of 8)
 MAXIMUM RANGE CRUISE PERFORMANCE
 (1900 RPM)

- CONDITIONS:
1. Power Levers - As Required To Obtain The Airspeed Shown.
 2. Landing Gear - Up.
 3. Wing Flaps - Up.
 4. Cowl Flaps - As Required.
 5. Inertial Separators - Normal.
 6. Heater - As Required.
- NOTE:
1. Where values are not presented, use Maximum Cruise Power 1900 RPM; refer to Figure 5-24.

| PRESSURE ALTITUDE- FEET | OAT °C | ICAT °C | 7300 POUNDS | | | | 8300 POUNDS | | | | 9360 POUNDS | | | |
|-------------------------|--------|---------|-----------------------------|------------------------|------|------|-----------------------------|------------------------|------|------|-----------------------------|------------------------|------|------|
| | | | FUEL FLOW PER ENGINE- LB/HR | FUEL FLOW TOTAL- LB/HR | KIAS | KTAS | FUEL FLOW PER ENGINE- LB/HR | FUEL FLOW TOTAL- LB/HR | KIAS | KTAS | FUEL FLOW PER ENGINE- LB/HR | FUEL FLOW TOTAL- LB/HR | KIAS | KTAS |
| ISA +20°C | 35 | 38 | 244 | 488 | 164 | 171 | 256 | 512 | 169 | 176 | 273 | 547 | 176 | 184 |
| | 31 | 34 | 234 | 468 | 162 | 174 | 247 | 494 | 168 | 180 | 263 | 526 | 174 | 187 |
| | 27 | 30 | 225 | 450 | 161 | 178 | 236 | 472 | 165 | 183 | 256 | 512 | 175 | 193 |
| 6000 | 23 | 27 | 214 | 428 | 158 | 180 | 226 | 452 | 163 | 186 | 246 | 491 | 172 | 196 |
| 8000 | 19 | 23 | 204 | 408 | 154 | 182 | 219 | 438 | 161 | 190 | 235 | 470 | 168 | 198 |
| 10,000 | 15 | 19 | 193 | 386 | 150 | 182 | 212 | 424 | 160 | 194 | 225 | 449 | 165 | 200 |
| 12,000 | 11 | 15 | 186 | 372 | 149 | 186 | 202 | 404 | 156 | 196 | 215 | 430 | 161 | 201 |
| 14,000 | 7 | 11 | 181 | 362 | 148 | 191 | 195 | 390 | 154 | 199 | 205 | 410 | 156 | 202 |
| 16,000 | 3 | 7 | 172 | 344 | 144 | 193 | 186 | 372 | 149 | 200 | 196 | 392 | 152 | 203 |
| 18,000 | -1 | 3 | 168 | 336 | 143 | 198 | 178 | 356 | 146 | 201 | 187 | 374 | 147 | 203 |
| 20,000 | -5 | -1 | 161 | 322 | 140 | 200 | 170 | 340 | 141 | 201 | 181 | 362 | 143 | 205 |
| 22,000 | -9 | -5 | 154 | 308 | 135 | 201 | 163 | 326 | 137 | 203 | 175 | 350 | 139 | 205 |
| 24,000 | -13 | -9 | 146 | 292 | 131 | 201 | 157 | 314 | 132 | 203 | 170 | 341 | 134 | 206 |

Figure 5-28 (Sheet 6 of 8)
MAXIMUM RANGE CRUISE PERFORMANCE
(1900 RPM)

CONDITIONS:
1. Power Levers - As Required To Obtain The Airspeed Shown.
2. Landing Gear - Up.
3. Wing Flaps - Up.
4. Cowl Flaps - As Required.
5. Inertial Separators - Normal.
6. Heater - As Required.

NOTE:

1. Where values are not presented, use Maximum Cruise Power 1900 RPM; refer to Figure 5-24.

| PRESSURE ALTITUDE- FEET | OAT °C | IOAT °C | 7300 POUNDS | | | | 8300 POUNDS | | | | 9360 POUNDS | | | |
|-------------------------|--------|---------|-----------------------------|------------------------|------|------|-----------------------------|------------------------|------|------|-----------------------------|------------------------|------|------|
| | | | FUEL FLOW PER ENGINE- LB/HR | FUEL FLOW TOTAL- LB/HR | KIAS | KTAS | FUEL FLOW PER ENGINE- LB/HR | FUEL FLOW TOTAL- LB/HR | KIAS | KTAS | FUEL FLOW PER ENGINE- LB/HR | FUEL FLOW TOTAL- LB/HR | KIAS | KTAS |
| ISA +30°C | 45 | 48 | 244 | 488 | 162 | 172 | 258 | 516 | 168 | 178 | 280 | 560 | 178 | 188 |
| | 41 | 44 | 233 | 466 | 160 | 174 | 251 | 502 | 168 | 183 | 272 | 544 | 178 | 194 |
| | 37 | 40 | 227 | 454 | 160 | 180 | 240 | 480 | 165 | 185 | 262 | 525 | 176 | 198 |
| | 33 | 37 | 216 | 432 | 157 | 182 | 236 | 472 | 167 | 193 | 250 | 500 | 172 | 199 |
| 8000 | 29 | 33 | 206 | 412 | 154 | 184 | 226 | 452 | 164 | 196 | 237 | 474 | 167 | 200 |
| 10,000 | 25 | 29 | 200 | 400 | 153 | 189 | 217 | 434 | 161 | 199 | 226 | 452 | 163 | 201 |
| 12,000 | 21 | 25 | 194 | 388 | 152 | 194 | 206 | 412 | 156 | 199 | 215 | 431 | 159 | 202 |
| 14,000 | 17 | 21 | 184 | 368 | 148 | 195 | 197 | 394 | 153 | 201 | 207 | 413 | 155 | 204 |
| 16,000 | 13 | 17 | 177 | 354 | 146 | 198 | 188 | 376 | 149 | 202 | 197 | 395 | 150 | 204 |
| 18,000 | 9 | 13 | 170 | 340 | 142 | 201 | 179 | 358 | 144 | 203 | 189 | 378 | 146 | 205 |
| 20,000 | 5 | 9 | 162 | 324 | 138 | 202 | 170 | 340 | 139 | 303 | 182 | 365 | 142 | 206 |
| 22,000 | 1 | 5 | 154 | 308 | 134 | 202 | 165 | 330 | 136 | 205 | 176 | 353 | 137 | 207 |

Figure 5-28 (Sheet 7 of 8)
MAXIMUM RANGE CRUISE PERFORMANCE
(1900 RPM)

CONDITIONS:

1. Power Levers - As Required To Obtain The Airspeed Shown.
2. Landing Gear - Up.
3. Wing Flaps - Up.
4. Cowl Flaps - As Required.
5. Inertial Separators - Normal.
6. Heater - As Required.

NOTE:

1. Where values are not presented, use Maximum Cruise Power 1900 RPM; refer to Figure 5-24.

| PRESSURE ALTITUDE - FEET | OAT °C | IOAT °C | 7300 POUNDS | | | | 8300 POUNDS | | | | 9360 POUNDS | | | | | | | | |
|--------------------------|--------|---------|------------------------------|-------------------------|------|------|------------------------------|-------------------------|------|------|------------------------------|-------------------------|------|------|-----|-----|-----|-----|-----|
| | | | FUEL FLOW PER ENGINE - LB/HR | FUEL FLOW TOTAL - LB/HR | KIAS | KTAS | FUEL FLOW PER ENGINE - LB/HR | FUEL FLOW TOTAL - LB/HR | KIAS | KTAS | FUEL FLOW PER ENGINE - LB/HR | FUEL FLOW TOTAL - LB/HR | KIAS | KTAS | | | | | |
| ISA +37°C | | | | | | | | | | | | | | | | | | | |
| Sea Level | 52 | 55 | 244 | 488 | 160 | 172 | 259 | 518 | 167 | 179 | 284 | 568 | 179 | 191 | 203 | 204 | 205 | 206 | 207 |
| 2000 | 48 | 51 | 233 | 466 | 158 | 174 | 249 | 498 | 165 | 182 | 277 | 555 | 179 | 198 | 204 | 205 | 206 | 207 | 208 |
| 4000 | 44 | 48 | 225 | 450 | 157 | 179 | 247 | 494 | 168 | 191 | 266 | 532 | 176 | 201 | 205 | 206 | 207 | 208 | 209 |
| 6000 | 40 | 44 | 218 | 436 | 156 | 183 | 239 | 478 | 167 | 196 | 252 | 503 | 172 | 201 | 205 | 206 | 207 | 208 | 209 |
| 8000 | 36 | 40 | 211 | 422 | 156 | 189 | 230 | 460 | 165 | 199 | 239 | 477 | 167 | 202 | 205 | 206 | 207 | 208 | 209 |
| 10,000 | 32 | 36 | 205 | 410 | 155 | 194 | 218 | 436 | 160 | 200 | 227 | 455 | 163 | 203 | 204 | 205 | 206 | 207 | 208 |
| 12,000 | 28 | 32 | 196 | 392 | 152 | 197 | 207 | 414 | 156 | 201 | 217 | 434 | 158 | 204 | 205 | 206 | 207 | 208 | 209 |
| 14,000 | 24 | 28 | 188 | 376 | 149 | 199 | 198 | 396 | 152 | 202 | 208 | 415 | 154 | 205 | 206 | 207 | 208 | 209 | 210 |
| 16,000 | 20 | 24 | 179 | 358 | 145 | 200 | 188 | 376 | 148 | 203 | 199 | 398 | 150 | 206 | 207 | 208 | 209 | 210 | 211 |
| 18,000 | 16 | 20 | 172 | 344 | 142 | 202 | 180 | 360 | 144 | 205 | 190 | 380 | 145 | 207 | 208 | 209 | 210 | 211 | 212 |
| 20,000 | 12 | 16 | 163 | 326 | 138 | 203 | 172 | 344 | 139 | 205 | 184 | 369 | 141 | 208 | 209 | 210 | 211 | 212 | 213 |

Figure 5-28 (Sheet 8 of 8)
MAXIMUM RANGE CRUISE PERFORMANCE
(1900 RPM)

- CONDITIONS:
1. Power Levers - As Required To Obtain The Airspeed Shown.
 2. Landing Gear - Up.
 3. Wing Flaps - Up.
 4. Cowl Flaps - As Required.
 5. Inertial Separators - Normal.
 6. Heater - As Required.
- NOTE:
1. Where values are not presented, use Maximum Cruise Power 1600 RPM; refer to Figure 5-27.

| PRESSURE ALTITUDE - FEET | OAT °C | IOAT °C | 7300 POUNDS | | | | 8300 POUNDS | | | | 9380 POUNDS | | | |
|--------------------------|--------|---------|------------------------------|-------------------------|------|------|------------------------------|-------------------------|------|------|------------------------------|-------------------------|------|------|
| | | | FUEL FLOW PER ENGINE - LB/HR | FUEL FLOW TOTAL - LB/HR | KIAS | KTAS | FUEL FLOW PER ENGINE - LB/HR | FUEL FLOW TOTAL - LB/HR | KIAS | KTAS | FUEL FLOW PER ENGINE - LB/HR | FUEL FLOW TOTAL - LB/HR | KIAS | KTAS |
| | | | Sea Level | -15 | -12 | 213 | 426 | 158 | 151 | 228 | 456 | 165 | 158 | 257 |
| 2000 | -19 | -16 | 201 | 403 | 154 | 152 | 229 | 457 | 171 | 168 | 243 | 486 | 177 | 174 |
| 4000 | -23 | -20 | 196 | 392 | 154 | 156 | 223 | 445 | 171 | 173 | 231 | 461 | 173 | 175 |
| 6000 | -27 | -24 | 197 | 395 | 160 | 167 | 210 | 421 | 167 | 173 | 218 | 435 | 168 | 175 |
| 8000 | -31 | -28 | 191 | 383 | 160 | 171 | 200 | 400 | 163 | 174 | 206 | 411 | 163 | 175 |
| 10,000 | -35 | -32 | 182 | 364 | 156 | 172 | 188 | 376 | 157 | 174 | 195 | 390 | 159 | 175 |
| 12,000 | -39 | -36 | 172 | 343 | 151 | 172 | 178 | 356 | 152 | 174 | 186 | 372 | 154 | 176 |
| 14,000 | -43 | -40 | 162 | 323 | 147 | 172 | 169 | 338 | 148 | 174 | 178 | 356 | 150 | 176 |
| 16,000 | -47 | -44 | 153 | 307 | 142 | 173 | 161 | 323 | 144 | 175 | 171 | 342 | 146 | 177 |
| 18,000 | -51 | -48 | 146 | 291 | 138 | 173 | 154 | 309 | 140 | 176 | 164 | 329 | 142 | 178 |

Figure 5-29 (Sheet 1 of 8)
MAXIMUM RANGE CRUISE PERFORMANCE
(1600 RPM)

EXAMPLE:
 Pressure Altitude - 10,000 Feet.
 Outside Air Temperature - -15 Degrees Celsius (ISA - 10 Degrees Celsius).
 Weight - 9000 Pounds.
 Airspeed (Approximation Method) - 178 KTAS (155 KIAS) Fuel Flow.
 Fuel Flow (Approximation Method) - 398 Pounds Per Hour Total - 199 Pounds Per Hour Per Engine.

- CONDITIONS:
1. Power Levers - As Required To Obtain The Airspeed Shown.
 2. Landing Gear - Up.
 3. Wing Flaps - Up.
 4. Cowl Flaps - As Required.
 5. Inertial Separators - Normal.
 6. Heater - As Required.
- NOTE:
1. Where values are not presented, use Maximum Cruise Power 1600 RPM; refer to Figure 5-27.

| PRESSURE ALTITUDE- FEET | OAT °C | IOAT °C | 7300 POUNDS | | | | 8300 POUNDS | | | | 9360 POUNDS | | | |
|-------------------------|--------|---------|-----------------------------|------------------------|------|------|-----------------------------|------------------------|------|------|-----------------------------|------------------------|------|------|
| | | | FUEL FLOW PER ENGINE- LB/HR | FUEL FLOW TOTAL- LB/HR | KIAS | KTAS | FUEL FLOW PER ENGINE- LB/HR | FUEL FLOW TOTAL- LB/HR | KIAS | KTAS | FUEL FLOW PER ENGINE- LB/HR | FUEL FLOW TOTAL- LB/HR | KIAS | KTAS |
| | | | ISA -20°C | -5 | -2 | 216 | 432 | 158 | 154 | 239 | 479 | 171 | 166 | 258 |
| 2000 | -9 | -6 | 205 | 411 | 154 | 154 | 234 | 468 | 171 | 171 | 245 | 490 | 175 | 175 |
| 4000 | -13 | -10 | 206 | 412 | 160 | 165 | 224 | 448 | 189 | 174 | 232 | 465 | 171 | 176 |
| 6000 | -17 | -14 | 202 | 404 | 161 | 171 | 212 | 424 | 165 | 175 | 220 | 440 | 167 | 177 |
| 8000 | -21 | -18 | 194 | 388 | 159 | 174 | 201 | 402 | 161 | 176 | 208 | 415 | 162 | 177 |
| 10,000 | -25 | -22 | 183 | 367 | 154 | 174 | 189 | 379 | 155 | 175 | 197 | 394 | 157 | 177 |
| 12,000 | -29 | -26 | 173 | 347 | 150 | 175 | 179 | 359 | 151 | 175 | 186 | 375 | 152 | 177 |
| 14,000 | -33 | -30 | 163 | 325 | 145 | 173 | 171 | 341 | 147 | 176 | 179 | 359 | 148 | 178 |
| 16,000 | -37 | -34 | 154 | 308 | 140 | 174 | 163 | 325 | 142 | 176 | 173 | 347 | 145 | 179 |
| 18,000 | -41 | -38 | 147 | 293 | 136 | 175 | 156 | 312 | 139 | 177 | 168 | 336 | 142 | 181 |
| 20,000 | -45 | -42 | 140 | 280 | 133 | 176 | 150 | 300 | 135 | 179 | 164 | 329 | 139 | 184 |
| 22,000 | -49 | -46 | 134 | 268 | 129 | 176 | 146 | 292 | 132 | 180 | 160 | 321 | 135 | 185 |
| 24,000 | -53 | -50 | 129 | 258 | 125 | 177 | 143 | 286 | 129 | 182 | 160 | 320 | 134 | 189 |

Figure 5-29 (Sheet 2 of 8)
MAXIMUM RANGE CRUISE PERFORMANCE
(1600 RPM)

CONDITIONS:
1. Power Levers - As Required To Obtain The Airspeed Shown.
2. Landing Gear - Up.
3. Wing Flaps - Up.
4. Cowl Flaps - As Required.
5. Inertial Separators - Normal.
6. Heater - As Required.

NOTE:

1. Where values are not presented, use Maximum Cruise Power 1600 RPM; refer to Figure 5-27.

| PRESSURE ALTITUDE- FEET | OAT °C | IOAT °C | 7300 POUNDS | | | | 8300 POUNDS | | | | 9360 POUNDS | | | |
|-------------------------|--------|---------|-----------------------------|------------------------|------|------|-----------------------------|------------------------|------|------|-----------------------------|------------------------|------|------|
| | | | FUEL FLOW PER ENGINE- LB/HR | FUEL FLOW TOTAL- LB/HR | KIAS | KTAS | FUEL FLOW PER ENGINE- LB/HR | FUEL FLOW TOTAL- LB/HR | KIAS | KTAS | FUEL FLOW PER ENGINE- LB/HR | FUEL FLOW TOTAL- LB/HR | KIAS | KTAS |
| | | | ISA -10°C | 5 | 8 | 220 | 439 | 158 | 156 | 244 | 489 | 171 | 170 | 259 |
| 2000 | 1 | 4 | 209 | 417 | 154 | 157 | 236 | 473 | 170 | 174 | 246 | 491 | 173 | 176 |
| 4000 | -3 | 0 | 211 | 422 | 161 | 169 | 224 | 448 | 166 | 175 | 233 | 467 | 169 | 178 |
| 6000 | -7 | -4 | 205 | 411 | 161 | 174 | 214 | 427 | 163 | 177 | 223 | 445 | 166 | 179 |
| 8000 | -11 | -8 | 195 | 391 | 157 | 175 | 204 | 407 | 160 | 178 | 210 | 421 | 161 | 179 |
| 10,000 | -15 | -12 | 185 | 370 | 153 | 176 | 192 | 384 | 155 | 178 | 199 | 398 | 155 | 178 |
| 12,000 | -19 | -16 | 175 | 350 | 149 | 176 | 181 | 362 | 150 | 177 | 190 | 380 | 151 | 179 |
| 14,000 | -23 | -20 | 165 | 330 | 144 | 176 | 172 | 344 | 145 | 177 | 183 | 366 | 148 | 181 |
| 16,000 | -27 | -24 | 156 | 312 | 139 | 176 | 165 | 330 | 141 | 178 | 178 | 355 | 145 | 183 |
| 18,000 | -31 | -28 | 148 | 297 | 135 | 177 | 159 | 318 | 138 | 180 | 172 | 343 | 141 | 184 |
| 20,000 | -35 | -32 | 142 | 283 | 131 | 177 | 153 | 307 | 135 | 182 | 168 | 336 | 138 | 187 |
| 22,000 | -39 | -36 | 136 | 277 | 129 | 180 | 149 | 299 | 132 | 184 | 165 | 330 | 135 | 189 |
| 24,000 | -43 | -39 | 132 | 265 | 125 | 181 | 146 | 292 | 129 | 186 | 164 | 328 | 133 | 192 |
| 26,000 | -47 | -43 | 130 | 260 | 122 | 183 | 145 | 290 | 126 | 189 | 163 | 327 | 130 | 195 |
| 28,000 | -51 | -47 | 127 | 254 | 119 | 184 | 145 | 289 | 124 | 192 | 164 | 328 | 127 | 197 |

Figure 5-29 (Sheet 3 of 8)
MAXIMUM RANGE CRUISE PERFORMANCE
(1600 RPM)

CONDITIONS:
 1. Power Levers - As Required To Obtain
 The Airspeed Shown.
 2. Landing Gear - Up.
 3. Wing Flaps - Up.
 4. Cowl Flaps - As Required.
 5. Inertial Separators - Normal.
 6. Heater - As Required.

NOTE:

1. Where values are not presented, use Maximum Cruise Power 1600 RPM; refer to Figure 5-27.

| ISA | PRESSURE ALTITUDE- FEET | OAT °C | IOAT °C | 7300 POUNDS | | | | 8300 POUNDS | | | | 9360 POUNDS | | | |
|-----|-------------------------|--------|---------|-----------------------------|------------------------|------|------|-----------------------------|------------------------|------|------|-----------------------------|------------------------|------|------|
| | | | | FUEL FLOW PER ENGINE- LB/HR | FUEL FLOW TOTAL- LB/HR | KIAS | KTAS | FUEL FLOW PER ENGINE- LB/HR | FUEL FLOW TOTAL- LB/HR | KIAS | KTAS | FUEL FLOW PER ENGINE- LB/HR | FUEL FLOW TOTAL- LB/HR | KIAS | KTAS |
| | Sea Level | 15 | 18 | 225 | 451 | 159 | 161 | 249 | 498 | 172 | 173 | 261 | 542 | 176 | 177 |
| | 2000 | 11 | 14 | 220 | 439 | 160 | 167 | 240 | 479 | 170 | 176 | 248 | 496 | 172 | 178 |
| | 4000 | 7 | 10 | 215 | 430 | 161 | 172 | 226 | 453 | 165 | 177 | 235 | 470 | 167 | 179 |
| | 6000 | 3 | 6 | 207 | 413 | 159 | 175 | 214 | 429 | 161 | 177 | 225 | 449 | 164 | 181 |
| | 8000 | -1 | 2 | 196 | 392 | 155 | 176 | 205 | 410 | 158 | 180 | 213 | 425 | 159 | 181 |
| | 10,000 | -5 | -2 | 186 | 373 | 152 | 178 | 194 | 389 | 154 | 180 | 201 | 402 | 154 | 180 |
| | 12,000 | -9 | -6 | 177 | 354 | 148 | 179 | 183 | 367 | 148 | 179 | 191 | 382 | 149 | 180 |
| | 14,000 | -13 | -10 | 167 | 333 | 142 | 178 | 173 | 347 | 143 | 179 | 186 | 373 | 147 | 183 |
| | 16,000 | -17 | -14 | 157 | 313 | 137 | 177 | 167 | 334 | 140 | 181 | 181 | 361 | 144 | 186 |
| | 18,000 | -21 | -18 | 150 | 300 | 134 | 179 | 162 | 324 | 137 | 183 | 176 | 351 | 141 | 188 |
| | 20,000 | -25 | -22 | 145 | 289 | 131 | 180 | 157 | 313 | 134 | 185 | 172 | 344 | 138 | 191 |
| | 22,000 | -29 | -25 | 140 | 280 | 128 | 182 | 153 | 306 | 131 | 187 | 168 | 336 | 135 | 192 |
| | 24,000 | -33 | -29 | 135 | 270 | 124 | 184 | 150 | 300 | 129 | 190 | 167 | 335 | 132 | 195 |
| | 26,000 | -37 | -33 | 133 | 266 | 122 | 187 | 149 | 297 | 126 | 192 | 168 | 336 | 130 | 199 |
| | 28,000 | -40 | -36 | 131 | 262 | 119 | 189 | 149 | 297 | 123 | 195 | 168 | 337 | 126 | 200 |

Figure 5-29 (Sheet 4 of 8)
 MAXIMUM RANGE CRUISE PERFORMANCE
 (1600 RPM)

CONDITIONS:
 1. Power Levers - As Required To Obtain The Airspeed Shown.
 2. Landing Gear - Up.
 3. Wing Flaps - Up.
 4. Cowl Flaps - As Required.
 5. Inertial Separators - Normal.
 6. Heater - As Required.

NOTE:

1. Where values are not presented, use Maximum Cruise Power 1600 RPM; refer to Figure 5-27.

| PRESSURE ALTITUDE- FEET | OAT °C | IOAT °C | 7300 POUNDS | | | | 8300 POUNDS | | | | 9360 POUNDS | | | |
|-------------------------|--------|---------|-----------------------------|------------------------|------|------|-----------------------------|------------------------|------|------|-----------------------------|------------------------|------|------|
| | | | FUEL FLOW PER ENGINE- LB/HR | FUEL FLOW TOTAL- LB/HR | KIAS | KTAS | FUEL FLOW PER ENGINE- LB/HR | FUEL FLOW TOTAL- LB/HR | KIAS | KTAS | FUEL FLOW PER ENGINE- LB/HR | FUEL FLOW TOTAL- LB/HR | KIAS | KTAS |
| | | | Sea Level | 25 | 28 | 234 | 468 | 163 | 167 | 251 | 302 | 170 | 175 | 262 |
| 2000 | 21 | 24 | 227 | 453 | 162 | 171 | 240 | 479 | 167 | 176 | 249 | 498 | 170 | 179 |
| 4000 | 17 | 20 | 219 | 438 | 161 | 175 | 228 | 455 | 163 | 178 | 237 | 474 | 166 | 181 |
| 6000 | 13 | 16 | 208 | 417 | 158 | 177 | 216 | 433 | 160 | 179 | 225 | 450 | 162 | 181 |
| 8000 | 9 | 12 | 198 | 396 | 154 | 178 | 206 | 412 | 155 | 181 | 215 | 431 | 158 | 183 |
| 10,000 | 5 | 8 | 188 | 377 | 150 | 179 | 196 | 393 | 152 | 182 | 204 | 409 | 153 | 183 |
| 12,000 | 1 | 4 | 178 | 356 | 146 | 180 | 186 | 373 | 148 | 182 | 195 | 390 | 149 | 183 |
| 14,000 | -3 | 0 | 169 | 337 | 141 | 181 | 176 | 353 | 142 | 181 | 190 | 379 | 146 | 186 |
| 16,000 | -7 | -4 | 159 | 318 | 136 | 179 | 170 | 341 | 140 | 184 | 184 | 369 | 144 | 189 |
| 18,000 | -11 | -7 | 153 | 306 | 133 | 182 | 165 | 330 | 137 | 186 | 180 | 360 | 141 | 191 |
| 20,000 | -15 | -11 | 147 | 294 | 130 | 183 | 160 | 320 | 134 | 188 | 176 | 351 | 138 | 193 |
| 22,000 | -19 | -15 | 142 | 284 | 127 | 185 | 156 | 312 | 131 | 190 | 172 | 344 | 134 | 195 |
| 24,000 | -23 | -19 | 138 | 276 | 124 | 187 | 153 | 305 | 128 | 192 | 172 | 343 | 132 | 198 |
| 26,000 | -27 | -23 | 136 | 272 | 122 | 190 | 152 | 304 | 125 | 196 | 172 | 344 | 129 | 201 |

Figure 5-29 (Sheet 5 of 8)
MAXIMUM RANGE CRUISE PERFORMANCE
 (1600 RPM)

- CONDITIONS:**
1. Power Levers - As Required To Obtain The Airspeed Shown.
 2. Landing Gear - Up.
 3. Wing Flaps - Up.
 4. Cowl Flaps - As Required.
 5. Inertial Separators - Normal.
 6. Heater - As Required.
- NOTE:**
1. Where values are not presented, use Maximum Cruise Power 1600 RPM; refer to Figure 5-27.

| PRESSURE ALTITUDE- FEET | OAT - °C | IOAT - °C | 7300 POUNDS | | | | 8300 POUNDS | | | | 9360 POUNDS | | | | | | | |
|-------------------------|----------|-----------|-----------------------------|------------------------|------|------|-----------------------------|------------------------|------|------|-----------------------------|------------------------|------|------|--|--|--|--|
| | | | FUEL FLOW PER ENGINE- LB/HR | FUEL FLOW TOTAL- LB/HR | KIAS | KTAS | FUEL FLOW PER ENGINE- LB/HR | FUEL FLOW TOTAL- LB/HR | KIAS | KTAS | FUEL FLOW PER ENGINE- LB/HR | FUEL FLOW TOTAL- LB/HR | KIAS | KTAS | | | | |
| ISA +20°C | | | | | | | | | | | | | | | | | | |
| Sea Level | 35 | 38 | 238 | 476 | 163 | 170 | 251 | 302 | 168 | 175 | 264 | 329 | 173 | 180 | | | | |
| 2000 | 31 | 34 | 229 | 458 | 161 | 173 | 241 | 482 | 166 | 178 | 251 | 501 | 168 | 181 | | | | |
| 4000 | 27 | 30 | 219 | 439 | 159 | 176 | 229 | 459 | 162 | 179 | 239 | 479 | 165 | 182 | | | | |
| 6000 | 23 | 26 | 209 | 417 | 155 | 177 | 218 | 436 | 158 | 181 | 227 | 454 | 160 | 183 | | | | |
| 8000 | 19 | 22 | 199 | 397 | 152 | 179 | 207 | 415 | 154 | 182 | 218 | 435 | 157 | 185 | | | | |
| 10,000 | 15 | 18 | 189 | 378 | 149 | 181 | 198 | 395 | 151 | 183 | 208 | 415 | 153 | 185 | | | | |
| 12,000 | 11 | 14 | 180 | 360 | 145 | 182 | 188 | 376 | 146 | 184 | 199 | 398 | 149 | 186 | | | | |
| 14,000 | 7 | 10 | 171 | 342 | 141 | 182 | 179 | 359 | 142 | 184 | 193 | 387 | 146 | 189 | | | | |
| 16,000 | 3 | 7 | 162 | 324 | 136 | 182 | 173 | 346 | 139 | 186 | 189 | 378 | 144 | 193 | | | | |
| 18,000 | -1 | 3 | 155 | 310 | 132 | 183 | 169 | 337 | 137 | 189 | 182 | 365 | 140 | 193 | | | | |
| 20,000 | -5 | -1 | 150 | 299 | 130 | 186 | 164 | 327 | 134 | 191 | 179 | 356 | 137 | 196 | | | | |
| 22,000 | -9 | -5 | 146 | 291 | 127 | 189 | 159 | 317 | 130 | 193 | 176 | 351 | 133 | 198 | | | | |
| 24,000 | -13 | -9 | 141 | 282 | 124 | 190 | 157 | 313 | 127 | 196 | 176 | 351 | 131 | 201 | | | | |

Figure 5-29 (Sheet 6 of 8)
MAXIMUM RANGE CRUISE PERFORMANCE
(1600 RPM)

NOTE: Where values are not presented, use Maximum
1. Cruise Power 1600 RPM; refer to Figure 5-27.

- CONDITIONS:
 1. Power Levers - As Required To Obtain The Airspeed Shown.
 2. Landing Gear - Up.
 3. Wing Flaps - Up.
 4. Cowl Flaps - As Required.
 5. Inertial Separators - Normal.
 6. Heater - As Required.

| PRESSURE ALTITUDE- FEET | OAT °C | IOAT °C | 7300 POUNDS | | | | 8300 POUNDS | | | | 9360 POUNDS | | | |
|-------------------------|--------|---------|-----------------------------|------------------------|------|------|-----------------------------|------------------------|------|------|-----------------------------|------------------------|------|------|
| | | | FUEL FLOW PER ENGINE- LB/HR | FUEL FLOW TOTAL- LB/HR | KIAS | KTAS | FUEL FLOW PER ENGINE- LB/HR | FUEL FLOW TOTAL- LB/HR | KIAS | KTAS | FUEL FLOW PER ENGINE- LB/HR | FUEL FLOW TOTAL- LB/HR | KIAS | KTAS |
| | | | ISA +30°C | 45 | 48 | 241 | 482 | 162 | 172 | 250 | 500 | 165 | 175 | 266 |
| Sea Level | 41 | 44 | 229 | 457 | 159 | 173 | 242 | 483 | 164 | 179 | 252 | 505 | 167 | 182 |
| 2000 | 37 | 40 | 220 | 440 | 157 | 177 | 231 | 461 | 160 | 181 | 240 | 479 | 162 | 183 |
| 4000 | 33 | 36 | 211 | 422 | 155 | 180 | 219 | 438 | 156 | 182 | 230 | 459 | 159 | 185 |
| 6000 | 29 | 32 | 200 | 400 | 151 | 180 | 209 | 417 | 153 | 183 | 221 | 442 | 156 | 187 |
| 8000 | | | | | | | | | | | | | | |
| 10,000 | 25 | 28 | 190 | 381 | 147 | 182 | 200 | 400 | 150 | 185 | 211 | 422 | 152 | 188 |
| 12,000 | 21 | 24 | 182 | 364 | 144 | 184 | 190 | 381 | 145 | 185 | 202 | 405 | 148 | 189 |
| 14,000 | 17 | 21 | 173 | 346 | 140 | 184 | 182 | 364 | 141 | 186 | 197 | 394 | 146 | 192 |
| 16,000 | 13 | 17 | 164 | 327 | 135 | 184 | 176 | 353 | 139 | 189 | 192 | 384 | 143 | 195 |
| 18,000 | 9 | 13 | 157 | 314 | 131 | 186 | 172 | 344 | 137 | 193 | 186 | 373 | 139 | 196 |
| 20,000 | 5 | 9 | 153 | 305 | 129 | 189 | 167 | 333 | 133 | 194 | 182 | 364 | 136 | 199 |
| 22,000 | 1 | 5 | 149 | 297 | 127 | 192 | 162 | 325 | 130 | 196 | 179 | 359 | 133 | 201 |

Figure 5-29 (Sheet 7 of 8)
MAXIMUM RANGE CRUISE PERFORMANCE
(1600 RPM)

- CONDITIONS:
1. Power Levers - As Required To Obtain The Airspeed Shown.
 2. Landing Gear - Up.
 3. Wing Flaps - Up.
 4. Cowl Flaps - As Required.
 5. Inertial Separators - Normal.
 6. Heater - As Required.
- NOTE: 1. Where values are not presented, use Maximum Cruise Power 1600 RPM; refer to Figure 5-27.

| PRESSURE ALTITUDE- FEET | OAT °C | IOAT °C | 7300 POUNDS | | | | 8300 POUNDS | | | | 9380 POUNDS | | | |
|-------------------------|--------|---------|-----------------------------|------------------------|------|------|-----------------------------|------------------------|------|------|-----------------------------|------------------------|------|------|
| | | | FUEL FLOW PER ENGINE- LB/HR | FUEL FLOW TOTAL- LB/HR | KIAS | KTAS | FUEL FLOW PER ENGINE- LB/HR | FUEL FLOW TOTAL- LB/HR | KIAS | KTAS | FUEL FLOW PER ENGINE- LB/HR | FUEL FLOW TOTAL- LB/HR | KIAS | KTAS |
| ISA +37°C | 52 | 55 | 242 | 483 | 161 | 173 | 252 | 503 | 164 | 176 | 266 | 532 | 169 | 181 |
| | 48 | 51 | 229 | 459 | 157 | 174 | 243 | 486 | 163 | 180 | 254 | 507 | 166 | 183 |
| | 44 | 47 | 220 | 439 | 155 | 177 | 232 | 463 | 159 | 181 | 241 | 483 | 162 | 184 |
| | 40 | 43 | 212 | 423 | 153 | 180 | 220 | 441 | 156 | 183 | 231 | 462 | 158 | 186 |
| | 36 | 39 | 201 | 402 | 150 | 181 | 210 | 421 | 152 | 184 | 223 | 447 | 156 | 189 |
| | 32 | 36 | 191 | 382 | 146 | 182 | 202 | 405 | 149 | 187 | 213 | 426 | 151 | 189 |
| 10,000 | 28 | 32 | 183 | 366 | 143 | 185 | 193 | 386 | 145 | 187 | 206 | 411 | 148 | 191 |
| 12,000 | 24 | 28 | 174 | 349 | 139 | 186 | 185 | 370 | 141 | 189 | 199 | 399 | 145 | 194 |
| 14,000 | 20 | 24 | 166 | 331 | 135 | 186 | 179 | 356 | 139 | 191 | 194 | 388 | 143 | 197 |
| 16,000 | 16 | 20 | 159 | 319 | 132 | 188 | 174 | 348 | 136 | 194 | 189 | 378 | 139 | 199 |
| 20,000 | 12 | 16 | 155 | 311 | 130 | 191 | 169 | 337 | 133 | 196 | 185 | 371 | 136 | 201 |

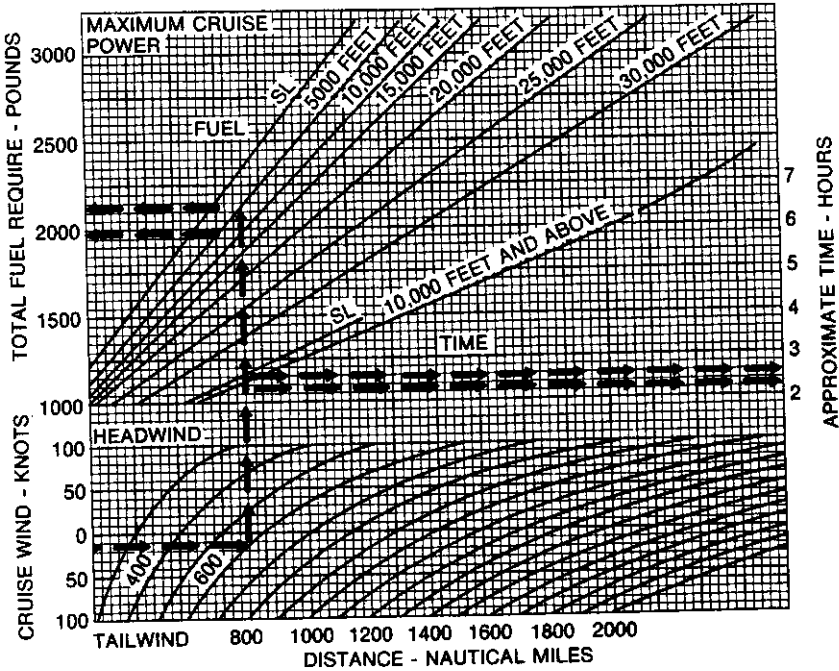
Figure 5-29 (Sheet 8 of 8)
MAXIMUM RANGE CRUISE PERFORMANCE
(1600 RPM)

CONDITIONS:

1. Takeoff Weight - 9360 pounds.
2. Cruise Climb To Desired Altitude.
3. Standard Day.
4. Power Control Levers - 1900 RPM.
5. Cowl Flaps - As Required.
6. Inertial Separators - Normal.
7. Heater - As Required.

NOTES:

1. Fuel required computations include fuel required for start, taxi, takeoff, climb, cruise, descent and 45 minutes reserve fuel at the particular cruise power and altitude.
2. The times and distances shown are those required for climb, cruise and descent.



EXAMPLE:

Tailwind - 15 Knots.
Distance - 600 Nautical Miles.

60856030

1. Pressure Altitude - 5000 Feet.

Fuel Required - 2125 Pounds.
Time Required - 2.55 Hours.

2. Pressure Altitude - 10,000 Feet.

Fuel Required - 1980 Pounds.
Time Required - 2.45 Hours.

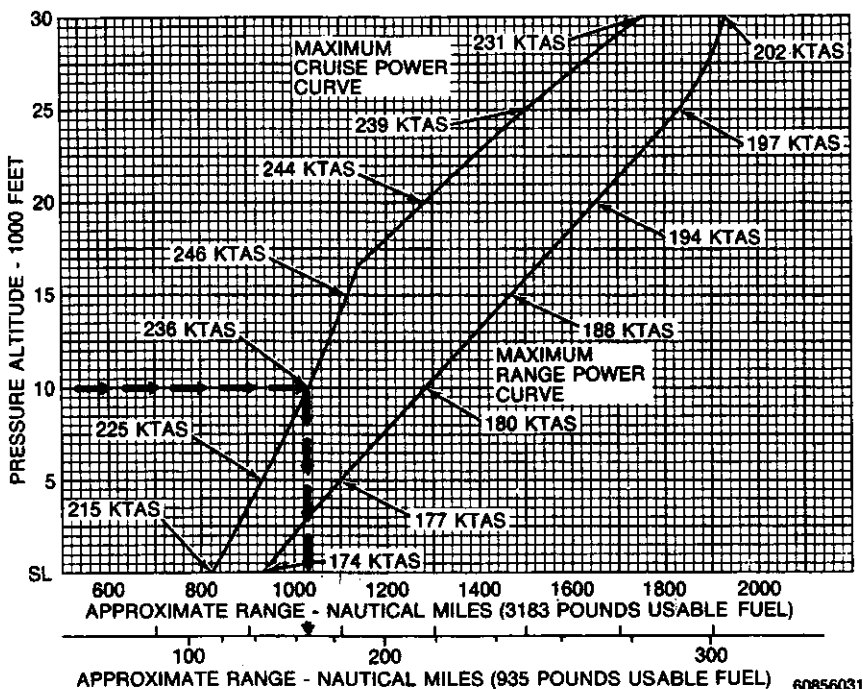
Figure 5-30
MAXIMUM CRUISE POWER FUEL REQUIRED

CONDITIONS:

1. Takeoff Weight - 9360 Pounds.
2. Cruise Climb to Desired Altitude.
3. Zero Wind.
4. Standard Day.
5. Propeller Control Levers - 1900 RPM.
6. Cowl Flaps - As Required.
7. Inertial Separator - Normal.
8. Heater - As Required.

NOTES:

1. Range computations include fuel required for start, taxi, takeoff, climb, cruise, descent and 45 minutes reserve fuel at the particular cruise power and altitude.
2. The distances shown are the sum of the times to climb, cruise and descend.
3. Fuel density - 6.70 pounds per gallon.



EXAMPLE:

Pressure Altitude - 10,000 Feet.
 Power Levers - Maximum Cruise Power.
 Fuel - 3183 Pounds.

Range - 1027 Nautical Miles.

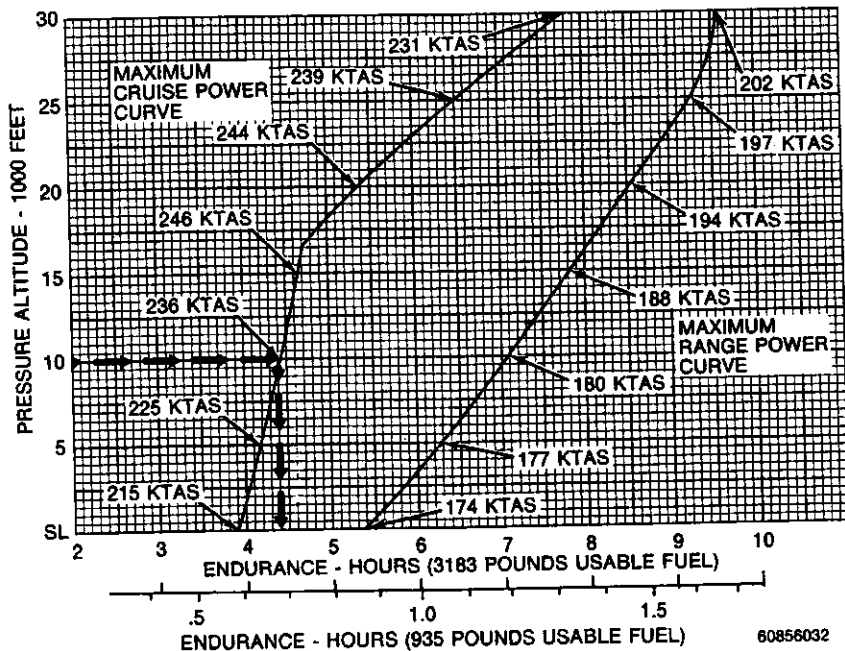
**Figure 5-31
RANGE PROFILE**

CONDITIONS:

1. Takeoff Weight - 9360 Pounds.
2. Cruise Climb To Desired Altitude.
3. Zero Wind.
4. Standard Day.
5. Propeller Control Levers - 1900 RPM.
6. Cowl Flaps - As Required.
7. Inertial Separators - Normal.
8. Heater - As Required.

NOTES:

1. Endurance computations include fuel required for start, taxi, takeoff, climb, cruise, descent and 45 minutes reserve fuel at the particular cruise power and altitude.
2. The endurance shown is the sum of the times to climb, cruise and descend.
3. Fuel density - 6.70 pounds per gallon.



EXAMPLE:

Pressure Altitude - 10,000 Feet.
Power Levers - Maximum Cruise Power.
Fuel - 3183 Pounds.

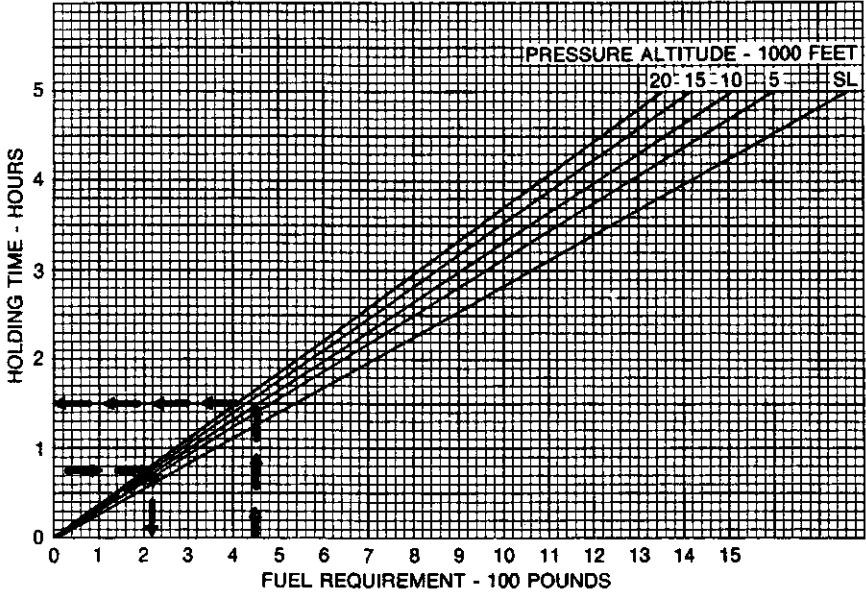
Endurance - 4.42 Hours.

Figure 5-32
ENDURANCE PROFILE

SPEED - 115 KIAS

CONDITIONS:

- 1. Torque - As Required to Maintain 115 KIAS.
- 2. Propeller Control Levers - 1600 RPM.
- 3. Landing Gear - Up.
- 4. Wing Flaps - Up.
- 7. Inertial Separator - Normal.
- 8. Heater - As Required.



60856035

EXAMPLE:

- 1. Required Holding Time - 45 Minutes (0.75 Hour).
Holding Pressure Altitude - 10,000 Feet.

Fuel Required - 226 Pounds.

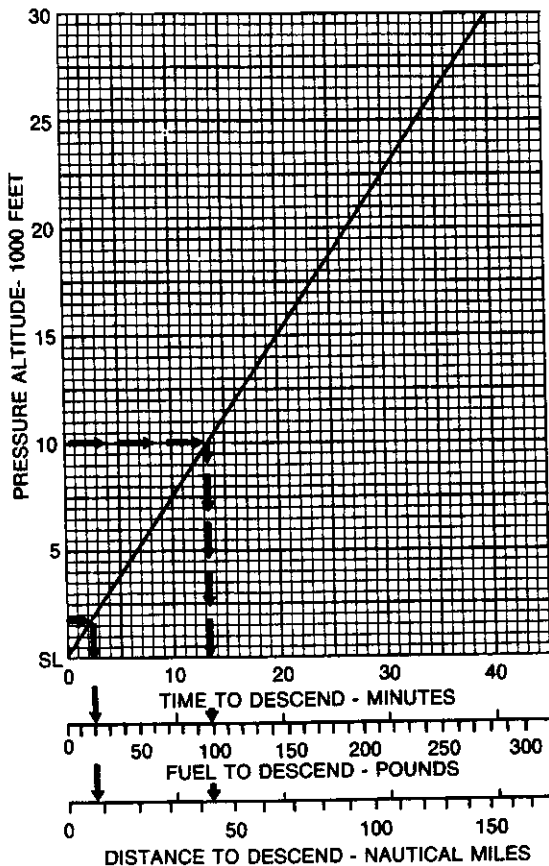
- 2. Fuel Available for Holding - 449 Pounds.
Holding Pressure Altitude - 10,000 Feet.

Holding Time - 1.5 Hours.

Figure 5-33
HOLDING TIME

CONDITIONS:

1. Power Levers - As Required to Maintain 750 FPM Rate-Of-Descent.
2. Propeller Control Levers - 1900 RPM
3. Landing Gear - Up.
4. Wing Flaps - Up.
5. Airspeed - 180 KIAS.
6. Heater - As Required.



60856033

EXAMPLE:

Initial Altitude - 10,000 Feet.
Final Altitude - 1,700 Feet.

Time to Descend (13.3 - 2.0) - 11.3 Minutes.
Fuel to Descend (99 - 19) - 80 Pounds.
Distance to Descend (43 - 7) - 36 Nautical Miles.

Figure 5-34
TIME, FUEL AND DISTANCE TO DESCEND

FACTOR 1/1.6 INCLUDED

EXAMPLE:

Pressure Altitude - 1700 Feet
 Outside Air Temperature - 7 Degrees Celsius
 Wind - 16 Knot Headwind Component
 Weight - 7524 Pounds
 Landing Field Length Required - 3900 Feet
 (Factor 1/1.6 Included)

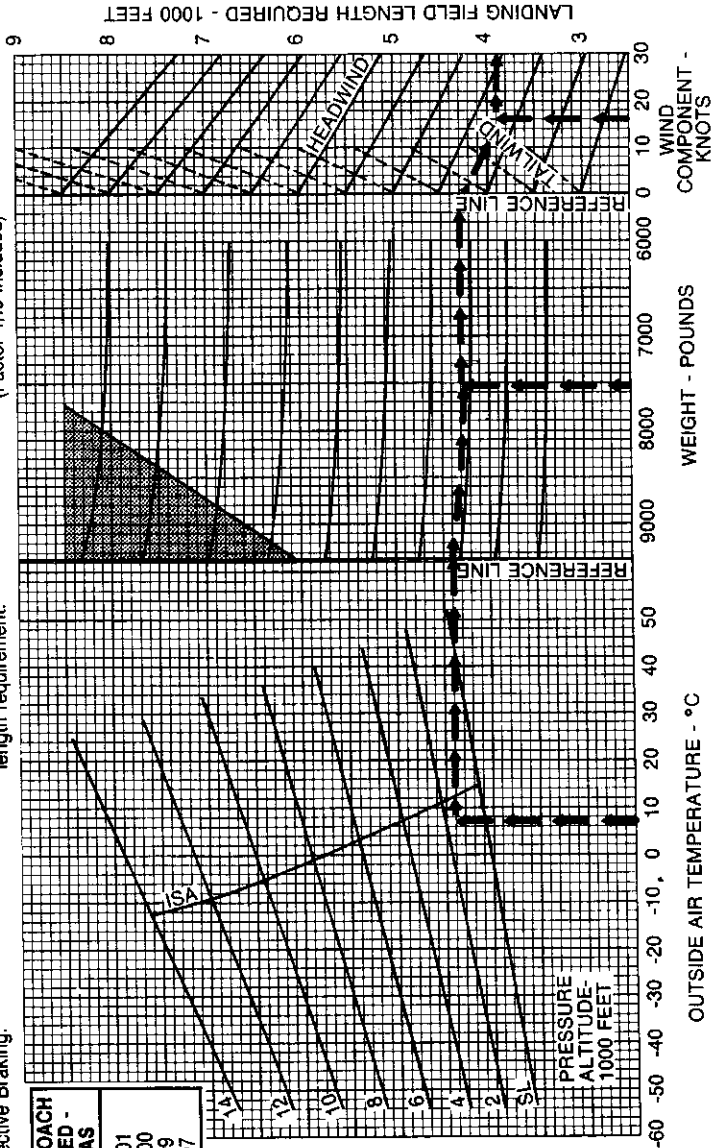
CONDITIONS:

1. POWER - As Required For 3 Degree Approach
 - Flight Idle Before Touchdown.
2. Propeller Control Levers - Forward.
3. Landing Gear - Down.
4. Wing Flaps - Down.
5. Level, Hard Surface Runway.
6. Maximum Effective Braking.

NOTES:

1. Values in shaded area indicate conditions exceeding demonstrated brake performance.
2. Multiply field length required by 0.857 to determine alternate airport field length requirement.

| WEIGHT POUNDS | APPROACH SPEED - KIAS |
|------------------|-----------------------------|
| 9360 | 101 |
| 8300 | 100 |
| 7300 | 99 |
| 6300 | 97 |



**Figure 5-35
LANDING FIELD LENGTH REQUIRED**

60856045

CONDITIONS:

1. POWER - As Required For 3 Degree Approach
- Flight Idle Before Touchdown.
2. Propeller Control Levers - Forward.
3. Landing Gear - Down.
4. Wing Flaps - Land.
5. Level, Hard Surface Runway.
6. Maximum Effective Braking.

NOTE:

1. Engine Inoperative Landing - Increase ground roll distance by 20 percent.
2. If necessary to land with wing flaps UP, the approach speed should be increased above the normal approach speed by 24 knots. Total landing distances can increase as much as 40 percent.
3. Decrease total distances 5 percent for each 10 knots headwind.
4. Increase total distances 20 percent for each 10 knots tailwind.
5. Values in shaded area indicates conditions exceeding demonstrated brake performance.

| WEIGHT- POUNDS | SPEED AT 50-FOOT OBSTACLE- KIAS | PRESSURE ALTITUDE- FEET | -20°C | | -10°C | | 0°C | | 10°C | |
|-------------------|--|-------------------------------|--------------------------|---|--------------------------|---|--------------------------|---|--------------------------|---|
| | | | GROUND ROLL - FEET | TOTAL DISTANCE TO CLEAR 50-FOOT OBSTACLE- FEET | GROUND ROLL - FEET | TOTAL DISTANCE TO CLEAR 50-FOOT OBSTACLE- FEET | GROUND ROLL - FEET | TOTAL DISTANCE TO CLEAR 50-FOOT OBSTACLE- FEET | GROUND ROLL - FEET | TOTAL DISTANCE TO CLEAR 50-FOOT OBSTACLE- FEET |
| 9360 | 101 | Sea Level | 1166 | 2305 | 1212 | 2356 | 1258 | 2407 | 1304 | 2459 |
| | | 1000 | 1242 | 2419 | 1292 | 2473 | 1340 | 2529 | 1389 | 2584 |
| | | 2000 | 1324 | 2538 | 1376 | 2597 | 1428 | 2656 | 1480 | 2716 |
| | | 3000 | 1409 | 2663 | 1465 | 2725 | 1521 | 2788 | 1576 | 2851 |
| | | 4000 | 1501 | 2794 | 1560 | 2861 | 1619 | 2928 | 1679 | 2995 |
| | | 5000 | 1596 | 2931 | 1659 | 3001 | 1723 | 3072 | 1786 | 3144 |
| | | 6000 | 1698 | 3074 | 1765 | 3148 | 1832 | 3224 | 1899 | 3299 |
| | | 7000 | 1806 | 3222 | 1877 | 3303 | 1948 | 3383 | 2020 | 3463 |
| | | 8000 | 1920 | 3379 | 1996 | 3464 | 2072 | 3550 | 2147 | 3635 |
| | | 9000 | 2039 | 3543 | 2120 | 3633 | 2201 | 3723 | 2289 | 3819 |
| | | 10,000 | 2167 | 3714 | 2252 | 3810 | 2335 | 3805 | 2424 | 4001 |
| | | 11,000 | 2302 | 3893 | 2394 | 3998 | 2494 | 4098 | 2575 | 4201 |
| | | 12,000 | 2444 | 4082 | 2541 | 4192 | 2637 | 4201 | 2724 | 4410 |
| | | 13,000 | 2595 | 4279 | 2694 | 4395 | 2701 | 4314 | 2804 | 4632 |
| | | 14,000 | 2756 | 4485 | 2854 | 4511 | 2773 | 4489 | 2882 | 4863 |

EXAMPLE :

- Outside Air Temperature - 7 Degrees Celsius.
- Pressure Altitude - 1700 Feet.
- Landing Weight - 7524 Pounds.
- Headwind Component - 16 Knots.

Ground Roll (Approximation Method) - 1425 Feet (1311 Feet With Wind Correction)
Total Over 50-Foot Obstacle (Approximation Method) - 2659 Feet (2446 Feet With Wind Correction)

Figure 5-36 (Sheet 1 of 8)
LANDING DISTANCE

CONDITIONS:

1. POWER - As Required For 3-Degree Approach
- Flight Idle Before Touchdown.
2. Propeller Control Levers - Forward.
3. Landing Gear - Down.
4. Wing Flaps - Land.
5. Level, Hard Surface Runway.
6. Maximum Effective Braking.

NOTE:

1. Engine Inoperative Landing - Increase ground roll distance by 20 percent. If necessary to land with wing flaps UP, the approach speed should be increased above the normal approach speed by 24 knots. Total landing distances can increase as much as 40 percent.
2. Decrease total distances 5 percent for each 10 knots headwind.
3. Increase total distances 20 percent for each 10 knots tailwind.
4. Values in shaded area indicates conditions exceeding demonstrated brake performance.

| WEIGHT- POUNDS | SPEED AT 50-FOOT OBSTACLE- KIAS | PRESSURE ALTITUDE- FEET | 20°C | | 30°C | | 40°C | | 50°C | |
|-------------------|--|-------------------------------|--------------------------|---|--------------------------|---|--------------------------|---|--------------------------|---|
| | | | GROUND ROLL - FEET | TOTAL DISTANCE TO CLEAR 50-FOOT OBSTACLE- FEET | GROUND ROLL - FEET | TOTAL DISTANCE TO CLEAR 50-FOOT OBSTACLE- FEET | GROUND ROLL - FEET | TOTAL DISTANCE TO CLEAR 50-FOOT OBSTACLE- FEET | GROUND ROLL - FEET | TOTAL DISTANCE TO CLEAR 50-FOOT OBSTACLE- FEET |
| | | | 9360 | 101 | Sea Level | 1350 | 2512 | 1396 | 2564 | 1442 |
| | | 1000 | 1439 | 2640 | 1487 | 2695 | 1536 | 2751 | 1586 | 2806 |
| | | 2000 | 1532 | 2775 | 1585 | 2834 | 1637 | 2892 | 1690 | 2951 |
| | | 3000 | 1632 | 2914 | 1687 | 2977 | 1744 | 3040 | -- | -- |
| | | 4000 | 1738 | 3062 | 1797 | 3128 | 1856 | 3195 | -- | -- |
| | | 5000 | 1848 | 3215 | 1911 | 3286 | 1974 | 3356 | -- | -- |
| | | 6000 | 1967 | 3375 | 2033 | 3450 | 2100 | 3525 | -- | -- |
| | | 7000 | 2091 | 3543 | 2163 | 3624 | 2234 | 3703 | -- | -- |
| | | 8000 | 2223 | 3718 | 2299 | 3804 | -- | -- | -- | -- |
| | | 9000 | 2362 | 3903 | 2442 | 3996 | -- | -- | -- | -- |
| | | 10,000 | 2509 | 4088 | 2585 | 4198 | -- | -- | -- | -- |
| | | 11,000 | 2657 | 4305 | 2757 | 4410 | -- | -- | -- | -- |
| | | 12,000 | 2830 | 4521 | 2928 | 4632 | -- | -- | -- | -- |
| | | 13,000 | 3005 | 4749 | -- | -- | -- | -- | -- | -- |
| | | 14,000 | 3191 | 4987 | -- | -- | -- | -- | -- | -- |

Figure 5-36 (Sheet 2 of 8)
LANDING DISTANCE

CONDITIONS:

1. POWER - As Required For 3 Degree Approach
- Flight Idle Before Touchdown.
2. Propeller Control Levers - Forward.
3. Landing Gear - Down.
4. Wing Flaps - Land.
5. Level, Hard Surface Runway.
6. Maximum Effective Braking.

NOTE:

1. Engine Inoperative Landing - Increase ground roll distance by 20 percent.
2. If necessary to land with wing flaps UP, the approach speed should be increased above the normal approach speed by 24 knots. Total landing distances can increase as much as 40 percent.
3. Decrease total distances 5 percent for each 10 knots headwind.
4. Increase total distances 20 percent for each 10 knots tailwind.
5. Values in shaded area indicates conditions exceeding demonstrated brake performance.

| WEIGHT- POUNDS | SPEED AT 50-FOOT OBSTACLE- KIAS | PRESSURE ALTITUDE- FEET | -20°C | | -10°C | | 0°C | | 10°C | |
|-------------------|--|-------------------------------|--------------------------|---|--------------------------|---|--------------------------|---|--------------------------|---|
| | | | GROUND ROLL - FEET | TOTAL DISTANCE TO CLEAR 50-FOOT OBSTACLE- FEET | GROUND ROLL - FEET | TOTAL DISTANCE TO CLEAR 50-FOOT OBSTACLE- FEET | GROUND ROLL - FEET | TOTAL DISTANCE TO CLEAR 50-FOOT OBSTACLE- FEET | GROUND ROLL - FEET | TOTAL DISTANCE TO CLEAR 50-FOOT OBSTACLE- FEET |
| 8300 | 100 | Sea Level | 1122 | 2258 | 1166 | 2309 | 1210 | 2359 | 1255 | 2410 |
| | | 1000 | 1196 | 2370 | 1243 | 2425 | 1291 | 2478 | 1338 | 2532 |
| | | 2000 | 1274 | 2487 | 1324 | 2544 | 1375 | 2601 | 1425 | 2659 |
| | | 3000 | 1357 | 2609 | 1410 | 2670 | 1465 | 2731 | 1518 | 2792 |
| | | 4000 | 1445 | 2737 | 1502 | 2801 | 1559 | 2866 | 1615 | 2930 |
| | | 5000 | 1537 | 2869 | 1597 | 2937 | 1659 | 3006 | 1719 | 3074 |
| | | 6000 | 1636 | 3008 | 1700 | 3081 | 1764 | 3154 | 1829 | 3227 |
| | | 7000 | 1738 | 3153 | 1807 | 3231 | 1875 | 3307 | 1944 | 3385 |
| | | 8000 | 1849 | 3305 | 1921 | 3387 | 1995 | 3470 | 2067 | 3554 |
| | | 9000 | 1963 | 3462 | 2041 | 3552 | 2118 | 3641 | 2196 | 3730 |
| | | 10,000 | 2087 | 3630 | 2169 | 3725 | 2251 | 3820 | 2334 | 3915 |
| | | 11,000 | 2217 | 3808 | 2303 | 3909 | 2391 | 4010 | 2479 | 4111 |
| | | 12,000 | 2354 | 3993 | 2447 | 4100 | 2539 | 4207 | 2633 | 4315 |
| | | 13,000 | 2500 | 4188 | 2598 | 4302 | 2697 | 4415 | 2795 | 4529 |
| | | 14,000 | 2654 | 4392 | 2758 | 4514 | 2863 | 4634 | 2988 | 4755 |

Figure 5-36 (Sheet 3 of 8)
LANDING DISTANCE

- CONDITIONS:**
1. POWER - As Required For 3 Degree Approach
 2. Propeller Control Levers - Forward.
 3. Landing Gear - Down.
 4. Wing Flaps - Land.
 5. Level, Hard Surface Runway.
 6. Maximum Effective Braking.
- NOTE:**
1. Engine Inoperative Landing - Increase ground roll distance by 20 percent.
 2. If necessary to land with wing flaps UP, the approach speed should be increased above the normal approach speed by 24 knots. Total landing distances can increase as much as 40 percent.
 3. Decrease total distances 5 percent for each 10 knots headwind.
 4. Increase total distances 20 percent for each 10 knots tailwind.
 5. Values in shaded area indicates conditions exceeding demonstrated brake performance.

| WEIGHT- POUNDS | SPEED AT 50-FOOT OBSTACLE- KIAS | PRESSURE ALTITUDE- FEET | 20°C | | 30°C | | 40°C | | 50°C | |
|-------------------|--|-------------------------------|--------------------------|---|--------------------------|---|--------------------------|---|--------------------------|---|
| | | | GROUND ROLL - FEET | TOTAL DISTANCE TO CLEAR 50-FOOT OBSTACLE- FEET | GROUND ROLL - FEET | TOTAL DISTANCE TO CLEAR 50-FOOT OBSTACLE- FEET | GROUND ROLL - FEET | TOTAL DISTANCE TO CLEAR 50-FOOT OBSTACLE- FEET | GROUND ROLL - FEET | TOTAL DISTANCE TO CLEAR 50-FOOT OBSTACLE- FEET |
| 8300 | 100 | Sea Level | 1299 | 2460 | 1343 | 2510 | 1388 | 2560 | 1432 | 2610 |
| | | 1000 | 1385 | 2585 | 1432 | 2639 | 1480 | 2692 | 1527 | 2746 |
| | | 2000 | 1475 | 2716 | 1526 | 2773 | 1575 | 2829 | 1626 | 2886 |
| | | 3000 | 1571 | 2852 | 1625 | 2912 | 1678 | 2973 | -- | -- |
| | | 4000 | 1673 | 2995 | 1730 | 3058 | 1787 | 3123 | -- | -- |
| | 5000 | 1780 | 3143 | 1840 | 3211 | 1901 | 3282 | -- | -- | |
| | 6000 | 1893 | 3301 | 1959 | 3374 | 2023 | 3449 | -- | -- | |
| | 7000 | 2013 | 3464 | 2081 | 3543 | 2150 | 3622 | -- | -- | |
| | 8000 | 2140 | 3638 | 2213 | 3723 | -- | -- | -- | -- | |
| | 9000 | 2274 | 3820 | 2351 | 3909 | -- | -- | -- | -- | |
| 10,000 | 2416 | 4012 | 2499 | 4107 | -- | -- | -- | -- | | |
| 11,000 | 2567 | 4212 | 2653 | 4313 | -- | -- | -- | -- | | |
| 12,000 | 2725 | 4422 | 2818 | 4529 | -- | -- | -- | -- | | |
| 13,000 | 2894 | 4643 | -- | -- | -- | -- | -- | -- | | |
| 14,000 | 3073 | 4876 | -- | -- | -- | -- | -- | -- | | |

Figure 5-36 (Sheet 4 of 8)
LANDING DISTANCE

CONDITIONS:

1. POWER - As Required For 3 Degree Approach
- Flight Idle Before Touchdown.
2. Propeller Control Levers - Forward.
3. Landing Gear - Down.
4. Wing Flaps - Land.
5. Level, Hard Surface Runway.
6. Maximum Effective Braking.

NOTE:

1. Engine Inoperative Landing - Increase ground roll distance by 20 percent.
2. if necessary to land with wing flaps UP, the approach speed should be increased above the normal approach speed by 24 knots. Total landing distances can increase as much as 40 percent.
3. Decrease total distances 5 percent for each 10 knots headwind.
4. Increase total distances 20 percent for each 10 knots tailwind.
5. Values in shaded area indicates conditions exceeding demonstrated brake performance.

| WEIGHT- POUNDS | SPEED AT 50-FOOT OBSTACLE- KIAS | PRESSURE ALTITUDE- FEET | -20 °C | | -10 °C | | 0 °C | | 10 °C | | | | | | | | | | | | | | | | | |
|-------------------|--|-------------------------------|--------------------------|---|--------------------------|---|--------------------------|---|--------------------------|---|-----------|------|------|------|------|------|------|------|------|------|--------|--------|--------|--------|--------|------|
| | | | GROUND ROLL - FEET | TOTAL DISTANCE TO CLEAR 50-FOOT OBSTACLE- FEET | GROUND ROLL - FEET | TOTAL DISTANCE TO CLEAR 50-FOOT OBSTACLE- FEET | GROUND ROLL - FEET | TOTAL DISTANCE TO CLEAR 50-FOOT OBSTACLE- FEET | GROUND ROLL - FEET | TOTAL DISTANCE TO CLEAR 50-FOOT OBSTACLE- FEET | | | | | | | | | | | | | | | | |
| | | | | | | | | | | | Sea Level | 1000 | 2000 | 3000 | 4000 | 5000 | 6000 | 7000 | 8000 | 9000 | 10,000 | 11,000 | 12,000 | 13,000 | 14,000 | |
| 7300 | 99 | | 1108 | 2236 | 1151 | 2285 | 1195 | 2335 | 1239 | 2384 | 1274 | 2452 | 1320 | 2504 | 1357 | 2573 | 1406 | 2629 | 1445 | 2701 | 1498 | 2760 | 1539 | 2833 | 1595 | 2897 |
| | | 5000 | 1517 | 2838 | 1578 | 2905 | 1637 | 2973 | 1698 | 3041 | 1742 | 3119 | 1805 | 3193 | 1851 | 3273 | 1920 | 3352 | 1969 | 3435 | 2040 | 3517 | 2092 | 3603 | 2169 | 3691 |
| | | 6000 | 1615 | 2974 | 1678 | 3045 | 1742 | 3119 | 1805 | 3193 | 1851 | 3273 | 1920 | 3352 | 1969 | 3435 | 2040 | 3517 | 2092 | 3603 | 2169 | 3691 | 2230 | 3781 | 2304 | 3874 |
| | | 7000 | 1716 | 3117 | 1784 | 3195 | 1851 | 3273 | 1920 | 3352 | 1969 | 3435 | 2040 | 3517 | 2092 | 3603 | 2169 | 3691 | 2230 | 3781 | 2304 | 3874 | 2361 | 3966 | 2448 | 4066 |
| | | 8000 | 1824 | 3268 | 1896 | 3351 | 1969 | 3435 | 2040 | 3517 | 2092 | 3603 | 2169 | 3691 | 2230 | 3781 | 2304 | 3874 | 2361 | 3966 | 2448 | 4066 | 2507 | 4162 | 2600 | 4268 |
| | | 9000 | 1939 | 3427 | 2015 | 3515 | 2092 | 3603 | 2169 | 3691 | 2230 | 3781 | 2304 | 3874 | 2361 | 3966 | 2448 | 4066 | 2507 | 4162 | 2600 | 4268 | 2661 | 4366 | 2760 | 4478 |
| | | 10,000 | 2060 | 3593 | 2142 | 3687 | 2223 | 3781 | 2304 | 3874 | 2361 | 3966 | 2448 | 4066 | 2507 | 4162 | 2600 | 4268 | 2661 | 4366 | 2760 | 4478 | 2827 | 4582 | 2930 | 4702 |
| | | 11,000 | 2188 | 3767 | 2274 | 3867 | 2361 | 3966 | 2448 | 4066 | 2507 | 4162 | 2600 | 4268 | 2661 | 4366 | 2760 | 4478 | 2827 | 4582 | 2930 | 4702 | 2990 | 4898 | 3040 | 5018 |
| | | 12,000 | 2323 | 3952 | 2416 | 4056 | 2507 | 4162 | 2600 | 4268 | 2661 | 4366 | 2760 | 4478 | 2827 | 4582 | 2930 | 4702 | 2990 | 4898 | 3040 | 5018 | 3090 | 5018 | 3140 | 5134 |
| | | 13,000 | 2467 | 4143 | 2564 | 4255 | 2661 | 4366 | 2760 | 4478 | 2827 | 4582 | 2930 | 4702 | 2990 | 4898 | 3040 | 5018 | 3090 | 5018 | 3140 | 5134 | 3190 | 5254 | 3240 | 5350 |
| | | 14,000 | 2619 | 4345 | 2723 | 4464 | 2827 | 4582 | 2930 | 4702 | 2990 | 4898 | 3040 | 5018 | 3090 | 5018 | 3140 | 5134 | 3190 | 5134 | 3240 | 5254 | 3290 | 5370 | 3290 | 5466 |

Figure 5-36 (Sheet 5 of 8)
LANDING DISTANCE

CONDITIONS:

1. POWER - As Required For 3 Degree Approach
- Flight Idle Before Touchdown.
2. Propeller Control Levers - Forward.
3. Landing Gear - Down.
4. Wing Flaps - Land.
5. Level, Hard Surface Runway.
6. Maximum Effective Braking.

NOTE:

1. Engine Inoperative Landing - Increase ground roll distance by 20 percent.
If necessary to land with wing flaps UP, the approach speed should be increased above the normal approach speed by 24 knots. Total landing distances can increase as much as 40 percent.
2. Decrease total distances 5 percent for each 10 knots headwind.
3. Increase total distances 20 percent for each 10 knots tailwind.
4. Values in shaded area indicates conditions exceeding demonstrated brake performance.

| WEIGHT- POUNDS | SPEED AT 50-FOOT OBSTACLE- KIAS | PRESSURE ALTITUDE- FEET | 20°C | | 30°C | | 40°C | | 50°C | |
|-------------------|--|-------------------------------|--------------------------|---|--------------------------|---|--------------------------|---|--------------------------|---|
| | | | GROUND ROLL - FEET | TOTAL DISTANCE TO CLEAR 50-FOOT OBSTACLE- FEET | GROUND ROLL - FEET | TOTAL DISTANCE TO CLEAR 50-FOOT OBSTACLE- FEET | GROUND ROLL - FEET | TOTAL DISTANCE TO CLEAR 50-FOOT OBSTACLE- FEET | GROUND ROLL - FEET | TOTAL DISTANCE TO CLEAR 50-FOOT OBSTACLE- FEET |
| | | | | | | | | | | |
| 7300 | 99 | Sea Level | 1283 | 2433 | 1326 | 2483 | 1370 | 2532 | 1414 | 2581 |
| | | 1000 | 1367 | 2556 | 1414 | 2609 | 1460 | 2661 | 1507 | 2714 |
| | | 2000 | 1456 | 2685 | 1506 | 2741 | 1555 | 2798 | 1605 | 2855 |
| | | 3000 | 1552 | 2820 | 1605 | 2881 | 1658 | 2941 | -- | -- |
| | | 4000 | 1651 | 2961 | 1708 | 3026 | 1763 | 3091 | -- | -- |
| | | 5000 | 1757 | 3110 | 1818 | 3179 | 1877 | 3248 | -- | -- |
| | | 6000 | 1870 | 3265 | 1933 | 3339 | 1997 | 3413 | -- | -- |
| | | 7000 | 1988 | 3430 | 2055 | 3507 | 2123 | 3585 | -- | -- |
| | | 8000 | 2112 | 3600 | 2185 | 3682 | -- | -- | -- | -- |
| | | 9000 | 2245 | 3780 | 2322 | 3868 | -- | -- | -- | -- |
| 10,000 | 2386 | 3968 | 2467 | 4062 | -- | -- | -- | -- | | |
| 11,000 | 2533 | 4164 | 2619 | 4294 | -- | -- | -- | -- | | |
| 12,000 | 2691 | 4374 | 2783 | 4479 | -- | -- | -- | -- | | |
| 13,000 | 2857 | 4591 | -- | -- | -- | -- | -- | -- | | |
| 14,000 | 3033 | 4821 | -- | -- | -- | -- | -- | -- | | |

Figure 5-36 (Sheet 6 of 8)
LANDING DISTANCE

CONDITIONS:

1. POWER - As Required For 3 Degree Approach
- Flight Idle Before Touchdown.
2. Propeller Control Levers - Forward.
3. Landing Gear - Down.
4. Wing Flaps - Land.
5. Level, Hard Surface Runway.
6. Maximum Effective Braking.

NOTE:

1. Engine Inoperative Landing - Increase ground roll distance by 20 percent.
2. If necessary to land with wing flaps UP, the approach speed should be increased above the normal approach speed by 24 knots. Total landing distance can increase as much as 40 percent.
3. Decrease total distances 5 percent for each 10 knots headwind.
4. Increase total distances 20 percent for each 10 knots tailwind.
5. Values in shaded area indicates conditions exceeding demonstrated brake performance.

| WEIGHT- POUNDS | SPEED AT 50-FOOT OBSTACLE- KIAS | PRESSURE ALTITUDE- FEET | -20°C | | -10°C | | 0°C | | 10°C | |
|-------------------|--|-------------------------------|--------------------------|---|--------------------------|---|--------------------------|---|--------------------------|---|
| | | | GROUND ROLL - FEET | TOTAL DISTANCE TO CLEAR 50-FOOT OBSTACLE- FEET | GROUND ROLL - FEET | TOTAL DISTANCE TO CLEAR 50-FOOT OBSTACLE- FEET | GROUND ROLL - FEET | TOTAL DISTANCE TO CLEAR 50-FOOT OBSTACLE- FEET | GROUND ROLL - FEET | TOTAL DISTANCE TO CLEAR 50-FOOT OBSTACLE- FEET |
| 6300 | 97 | Sea Level | 1112 | 2228 | 1156 | 2277 | 1200 | 2326 | 1244 | 2375 |
| | | 1000 | 1186 | 2337 | 1233 | 2390 | 1279 | 2442 | 1327 | 2495 |
| | | 2000 | 1264 | 2453 | 1313 | 2509 | 1363 | 2563 | 1413 | 2619 |
| | | 3000 | 1345 | 2571 | 1399 | 2631 | 1452 | 2691 | 1505 | 2752 |
| | | 4000 | 1432 | 2696 | 1489 | 2760 | 1544 | 2824 | 1601 | 2889 |
| | | 5000 | 1524 | 2827 | 1583 | 2895 | 1644 | 2965 | 1704 | 3033 |
| | | 6000 | 1620 | 2965 | 1685 | 3037 | 1748 | 3110 | 1812 | 3184 |
| | | 7000 | 1723 | 3108 | 1791 | 3186 | 1859 | 3264 | 1927 | 3342 |
| | | 8000 | 1831 | 3259 | 1904 | 3343 | 1976 | 3425 | 2048 | 3507 |
| | | 9000 | 1946 | 3417 | 2023 | 3505 | 2100 | 3593 | 2176 | 3680 |
| | | 10,000 | 2067 | 3583 | 2150 | 3675 | 2230 | 3769 | 2313 | 3861 |
| | | 11,000 | 2196 | 3757 | 2282 | 3855 | 2369 | 3955 | 2457 | 4053 |
| | | 12,000 | 2333 | 3939 | 2425 | 4044 | 2516 | 4150 | 2609 | 4254 |
| | | 13,000 | 2477 | 4131 | 2575 | 4242 | 2672 | 4354 | 2771 | 4465 |
| | | 14,000 | 2628 | 4331 | 2733 | 2837 | 4568 | 2941 | 4687 | |

Figure 5-36 (Sheet 7 of 8)
LANDING DISTANCE

CONDITIONS:

1. POWER - As Required For 3 Degree Approach
- Flight Idle Before Touchdown.
2. Propeller Control Levers - Forward.
3. Landing Gear - Down.
4. Wing Flaps - Land.
5. Level, Hard Surface Runway.
6. Maximum Effective Braking.

NOTE:

1. Engine Inoperative Landing - Increase ground roll distance by 20 percent.
2. If necessary to land with wing flaps UP, the approach speed should be increased above the normal approach speed by 24 knots. Total landing distances can increase as much as 40 percent.
3. Decrease total distances 5 percent for each 10 knots headwind.
4. Increase total distances 20 percent for each 10 knots tailwind.
5. Values in shaded area indicates conditions exceeding demonstrated brake performance.

| WEIGHT- POUNDS | SPEED AT 50-FOOT OBSTACLE- KIAS | PRESSURE ALTITUDE- FEET | 20°C | | 30°C | | 40°C | | 50°C | |
|-------------------|--|-------------------------------|--------------------------|---|--------------------------|---|--------------------------|---|--------------------------|---|
| | | | GROUND ROLL - FEET | TOTAL DISTANCE TO CLEAR 50-FOOT OBSTACLE- FEET | GROUND ROLL - FEET | TOTAL DISTANCE TO CLEAR 50-FOOT OBSTACLE- FEET | GROUND ROLL - FEET | TOTAL DISTANCE TO CLEAR 50-FOOT OBSTACLE- FEET | GROUND ROLL - FEET | TOTAL DISTANCE TO CLEAR 50-FOOT OBSTACLE- FEET |
| | | | 6300 | 97 | Sea Level | 1288 | 2424 | 1332 | 2473 | 1376 |
| | | 1000 | 1373 | 2547 | 1420 | 2601 | 1466 | 2654 | 1514 | 2708 |
| | | 2000 | 1463 | 2677 | 1513 | 2734 | 1563 | 2791 | 1612 | 2848 |
| | | 3000 | 1558 | 2812 | 1611 | 2873 | 1664 | 2933 | -- | -- |
| | | 4000 | 1658 | 2953 | 1715 | 3017 | 1771 | 3082 | -- | -- |
| | | 5000 | 1765 | 3102 | 1824 | 3170 | 1885 | 3239 | -- | -- |
| | | 6000 | 1877 | 3256 | 1940 | 3330 | 2004 | 3402 | -- | -- |
| | | 7000 | 1995 | 3419 | 2063 | 3497 | 2132 | 3575 | -- | -- |
| | | 8000 | 2121 | 3589 | 2193 | 3673 | -- | -- | -- | -- |
| | | 9000 | 2254 | 3767 | 2330 | 3855 | -- | -- | -- | -- |
| | | 10,000 | 2395 | 3955 | 2475 | 4049 | -- | -- | -- | -- |
| | | 11,000 | 2543 | 4153 | 2630 | 4251 | -- | -- | -- | -- |
| | | 12,000 | 2701 | 4359 | 2794 | 4465 | -- | -- | -- | -- |
| | | 13,000 | 2868 | 4577 | -- | -- | -- | -- | -- | -- |
| | | 14,000 | 3045 | 4804 | -- | -- | -- | -- | -- | -- |

Figure 5-36 (Sheet 8 of 8)
LANDING DISTANCE

1

1

**SECTION 6
WEIGHT AND BALANCE**

TABLE OF CONTENTS

| | Page |
|--|-------------------|
| INTRODUCTION | 6-3 |
| AIRPLANE WEIGHING PROCEDURE | 6-3 |
| WEIGHT AND BALANCE RECORD | 6-7 |
| WEIGHT AND BALANCE DETERMINATION FOR FLIGHT .. | 6-7 |
| AIRPLANE WEIGHING FORM | 6-9 |
| WEIGHT AND MOMENT TABLE | 6-10 |
| CENTER-OF-GRAVITY LIMITS ENVELOPE GRAPH | 6-16 |
| SAMPLE WEIGHT AND BALANCE COMPUTATION FORM . | 6-17 |
| WEIGHT AND BALANCE RECORD | 6-18 |
| EQUIPMENT LIST | 6-19 (6-20 blank) |
| WEIGHT AND BALANCE COMPUTATION FORM | 6-19 (6-20 blank) |

(

)

INTRODUCTION

Section 6 of this handbook provides procedures for establishing the airplane's basic empty weight and moment and procedures for determining the weight and balance for flight. This section also describes all items on the Weight and Balance Data sheet which was provided with the airplane (located in the back of this handbook in a plastic envelope) as delivered from Cessna Aircraft Company.

NOTE

It is the responsibility of the operator to ensure that the airplane is loaded properly.

AIRPLANE WEIGHING PROCEDURE**To Establish Basic Empty Weight**

The airplane must be weighed in the following configuration.

1. Wing flaps shall be fully retracted and all other control surfaces shall be in neutral.
2. Service engine oil and landing gear hydraulic fluid reservoir as required to obtain a normal full indication.
3. Check landing gear down and parking brake released.
4. Remove all equipment and items not to be included in basic empty weight such as tools, contents in cabinets and drawers and floor-mats.
5. All equipment and furnishings must be in their standard location to facilitate corrections to "Airplane Standard Empty Weight" and "Center-of-Gravity" location.
6. All seats shall be properly installed on tracks and placed in the most forward position against the seat stop. All seat backs shall be in the vertical position and seat belts crossed on the seat cushion.
7. Close all baggage doors, tailcone access door, main cabin door and emergency exit windows.
8. Clean the airplane inside and out.
9. Remove all snow, ice or water which may be on the airplane.
10. Weigh the airplane in a closed hangar to avoid errors caused by air currents.
11. Defuel the airplane in accordance with the following steps.

WARNING

CONDUCT ALL DEFUELING OPERATIONS AT A SAFE DISTANCE FROM OTHER AIRPLANES AND BUILDINGS. FIRE FIGHTING EQUIPMENT MUST BE READILY AVAILABLE. ATTACH TWO GROUND WIRES FROM DIFFERENT POINTS ON THE AIRPLANE TO SEPARATE APPROVED GROUNDING STAKES. THE USE OF TWO GROUND WIRES WILL PREVENT UNGROUNDING OF THE AIRPLANE DUE TO ACCIDENTAL DISCONNECTING OF EITHER WIRE.

- a. Turn off all electrical power.
- b. Turn crossfeed selector OFF.
- c. Remove engine cowl.
- d. Disconnect the engine fuel supply line on each engine and insert these lines into suitable fuel containers.
- e. Apply external power to the airplane.
- f. Energize the fuel boost pumps until fuel flow is terminated.

CAUTION

TO PREVENT DAMAGE TO THE FUEL BOOST PUMPS, SHUT OFF THE PUMPS AS SOON AS FUEL FLOW IS TERMINATED.

- g. Drain the remaining fuel through the fuel drain and crossfeed valves into an appropriate container. Each drain should remain open until the defueling rate slows to approximately 1 drop per second.
- h. The fuel remaining on-board after defueling is residual fuel and is included in the basic empty weight.
- i. Drainable unusable fuel must be added after the weighing to obtain basic empty weight. Figure 6-1 includes the weight and arms necessary to add the drainable unusable fuel.

12. Leveling

NOTE

The airplane must be level during weighing to determine the Center-of-Gravity. Always level laterally before leveling longitudinally.

a. On landing Gear

- (1) Inflate the main gear struts to maximum extension and the nose gear strut to minimum extension.
- (2) Place scales under nose wheel and each main wheel.
- (3) To level laterally, place a spirit level directly on the seat tracks over the main spar fuselage station 177.45. Adjust the main gear tire or strut pressure to center the bubble.
- (4) To level longitudinally, unscrew the two screws approximately 0.25 inch at "Level Point" on the right side of the fuselage at Stations 248.25 and 272.65. Place the level on these screws and level longitudinally by adjusting the nose wheel tire or strut pressure to center the bubble.

b. On Jack Points

CAUTION

KEEP THE AIRPLANE LEVEL WHILE JACKING TO PREVENT SLIPPING OFF JACK POINT AND DAMAGING THE AIRPLANE.

NOTE

When possible, secure nose gear strut to prevent extension. This will allow minimum total jacking height.

- (1) Raise the airplane with the hoisting jacks until all wheels are clear of the floor.
- (2) To level laterally, place a level directly on the seat tracks over the main spar fuselage station 177.45. Raise or lower the jacks under the wing jack points until the level bubble centers.
- (3) To level longitudinally, unscrew the two "Level Point" screws approximately 0.25 inch on the right side of the fuselage at Stations 248.25 and 272.65. Place a level on these screws and raise or lower the nose jack until the level bubble centers.

13. When weighing on the wheels or jack points with mechanical scales, ensure the scales are in calibration within the last 6 months and used per the manufacturer's recommendations. When weighing on the wheels, deflate or inflate the gear struts and/or tires until the airplane is level. Gear struts and/or tires must be serviced per maintenance manual before airplane is put back into service.
14. When weighing on the jack points with electronic weighing scales, attach the electronic weighing cells to the proper mounting adapters to prevent slipping.
 - a. Prepare the electronic weighing kit, which has been calibrated or certified correct in the last 12 months, for use by following the manufacturer's instructions provided with the weighing kit. Adjust all jacks simultaneously until the cells are in contact with the jack points. Continue jacking, keeping the airplane level, until the airplane is supported at the jack points only.
15. Determine scale reading, scale drift and tare from all three scales.
16. Lower the airplane and clear the weighing cells as soon as the readings are obtained.
17. Computations (refer to Figure 6-1).
 - a. Enter the scale reading, scale drift and tare from all three scales in the columns in the Airplane As Weighed Table. Compute and enter values for the Net Weight and Airplane Total As Weighed columns.
 - b. Determine the Center-of-Gravity arm of the airplane using the formula presented in Figure 6-1.
 - c. Enter the total Net Weight and Center-of-Gravity Arm in the Basic Empty Weight and Center-of-Gravity Table columns. Multiply the Weight (Pounds) entry times the Center-of-Gravity Arm (Inches) entry to determine Moment (Inches-Pounds/100) entry. Total each of the three columns to determine basic empty weight, Center-of-Gravity arm and moment.

NOTE

An attempt should be made to verify the results of each weighing, when data for comparison is available.

- d. Enter Basic Empty Weight, Center-of-Gravity arm and moment in the Weight and Balance Computation Form, refer to 6-4 and the Weight and Balance Record, refer to Figure 6-5.

WEIGHT AND BALANCE RECORD

The Weight and Balance Record, refer to Figure 6-5, provides a record to reflect the continuous history of changes in airplane structure and/or equipment which affects the weight and balance of the airplane.

The Basic Empty Weight of your airplane is entered at the appropriate location on the Weight and Balance Data sheet as delivered from the factory. Changes to the structure or equipment should be entered on the Weight and Balance Record when any modifications are made to the airplane. It is the responsibility of the airplane owner to assure this record is up to date, as all loadings will be based on the latest entry.

WEIGHT AND BALANCE DETERMINATION FOR FLIGHT

The following is a sample weight and balance determination. For an actual determination for your airplane, refer to the equivalent illustrations on the Weight and Balance Data sheet provided in your airplane.

To compute the weight and balance for your airplane, use Figures 6-2 through 6-5 as follows:

Take the Basic Empty Weight and Moment/100 from the latest entry shown on the Weight and Balance Data sheet or Weight and Balance Record and enter them in item 1 (Basic Empty Weight) of Figure 6-4. For this sample, assume a weight of 5190 pounds and moment/100 of 8884.59.

NOTE

A blank Weight and Balance Form is provided, for the operator's convenience, at the end of this section.

Determine arm, weight and moment/100 of the crew, passengers, baggage and cabinet contents from Figures 6-2 and 6-3 and enter them under Payload Computations in Figure 6-4. The crew and passenger loading table is applicable only when the Center-of-Gravity of the occupant is at the location specified.

If the seats are in any other position than stated in Figure 6-2, the moment must be computed by multiplying occupant weight times the arm in inches. A point 9 inches forward of the intersection of the seat bottom and seat back with seat cushions compressed can be assumed to be the occupant Center-of-Gravity. For a reference in determining the arm, the aft end of the cabin seat tracks is fuselage station 289.08.

Refer to Figure 6-4. Total the Payload Computations items and enter the resulting Weight and Moment/100 in item 2.

Refer to Figure 6-4. Total items 1 (Basic Empty Weight) and 2 (Fuselage Payload) to determine appropriate entries for item 3 (Zero Fuel Weight with Zero Wing Locker Payload).

Refer to Figure 6-4. Item 4 (Wing Locker Payload) is determined from the applicable Table of Figure 6-2.

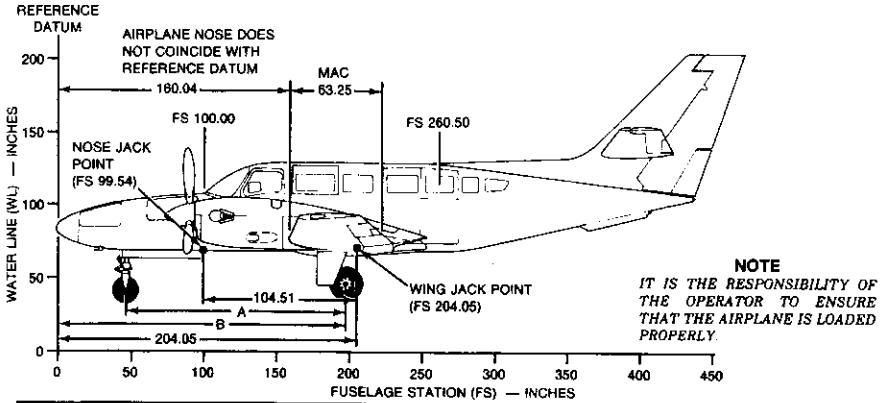
Refer to Figure 6-4. Item 5 (Fuel Loading) is determined from the applicable Table of Figure 6-2.

Total items 3, 4 and 5 to determine 6 (Ramp Weight). Enter item 6 totals in Figure 6-3 to determine if the loading is within allowable limits. If the point falls within the envelope, the loading is approved. If the point falls outside the envelope, it will be necessary to redistribute the load.

Refer to Figure 6-4. Subtract item 7 (Less Fuel For Taxiing) from item 6 (Ramp Weight) to determine item 8 (Takeoff Weight). The moment of the fuel used for taxiing is determined by the difference in moments of the fuel loaded and the fuel remaining after taxi. Enter item 8 totals in Figure 6-3 to determine if the loading is within allowable limits (takeoff weight must never exceed 9360 pounds). If the point falls outside of the envelope, it will be necessary to redistribute the load.

Refer to Section 5 for estimated fuel used during the flight. Determine the estimated weight of the fuel to be used. The moment is determined by the difference in moments of the fuel remaining after taxi and the fuel remaining after reaching the destination. Obtain Moment/100 from Figure 6-2. Enter the total of these weights and Moment/100 in item 9 (Less Fuel To Destination).

Item 9 (Landing Weight) is determined by subtracting item 9 from item 8. Enter item 10 totals in Figure 6-3 to determine if the loading is within allowable limits. If the point falls within the envelope, the loading is approved. If the point falls outside the envelope, it will be necessary to redistribute the load.



LOCATING CG WITH AIRPLANE ON LANDING GEAR

LEGEND

Dimension A = Horizontal distance from center of main landing gear axle to center of nose landing gear axle (determined by measurement after airplane is level on scales).

Dimension B = Horizontal distance from reference datum to center of nose landing gear axle. Obtain this distance by measuring from nose jack point FS 99.54 to center of nose landing gear axle and subtracting this value from dimension A and adding to FS 99.54. (Must be measured after airplane is level on scales.)

FORMULA for Longitudinal CG

$$\text{CG Arm of Airplane} = (\text{Dimension B}) - \frac{(\text{Dimension A}) \times (\text{Nose Landing Gear Net Weight})}{\text{Nose and Main Landing Gear Weight Totaled}} - (\text{Inches}) \text{ } \left(\begin{array}{l} \text{Aft of} \\ \text{Datum} \end{array} \right)$$

LOCATING CG WITH AIRPLANE ON JACK PADS

FORMULA for Longitudinal CG

$$\text{CG Arm of Airplane} = 204.05 - \frac{104.51 \times (\text{Nose Jack Point Net Weight})}{\text{Nose and Wing Jack Point Weight Totaled}} - (\text{Inches}) \text{ } \left(\begin{array}{l} \text{Aft of} \\ \text{Datum} \end{array} \right)$$

LEVELING PROVISIONS

LONGITUDINAL — RIGHT SIDE OF FUSELAGE AT FS 248.25 AND FS 272.65
LATERAL — ON SEAT TRACKS OVER MAIN SPAR

LOCATING PERCENT MAC

FORMULA for Percent MAC

$$\text{CG Percent MAC} = \frac{(\text{CG Arm of Airplane}) - 160.04}{0.6325}$$

AIRPLANE AS WEIGHED TABLE

| POSITION | SCALE READING | SCALE DRIFT | TARE | NET WEIGHT |
|---------------------------|---------------|-------------|------|------------|
| LEFT WING | | | | |
| RIGHT WING | | | | |
| NOSE | | | | |
| AIRPLANE TOTAL AS WEIGHED | | | | |

BASIC EMPTY WEIGHT AND CENTER-OF-GRAVITY TABLE

| ITEM | WEIGHT (POUNDS) | CG ARM (INCHES) | MOMENT (INCH-POUNDS/100) |
|---|-----------------|-----------------|--------------------------|
| AIRPLANE (CALCULATED OR AS WEIGHED) (INCLUDES ALL UNDRAINABLE FLUIDS AND FULL OIL) | | | |
| DRAINABLE UNUSABLE FUEL AT 6.70 POUNDS PER GALLON | 44.00 | 186.70 | 82.15 |
| | | | |
| BASIC EMPTY WEIGHT | | | |

1672-1

**Figure 6-1
AIRPLANE WEIGHING FORM**

FUEL LOADING

| WEIGHT (POUNDS) | MOMENT/100 ARM VARIES (INCH-POUNDS) | WEIGHT (POUNDS) | MOMENT/100 ARM VARIES (INCH-POUNDS) | WEIGHT (POUNDS) | MOMENT/100 ARM VARIES (INCH-POUNDS) |
|--------------------|---|--------------------|---|--------------------|---|
| 20 | 37.48 | 1100 | 2025.72 | 2160 | 3945.80 |
| 40 | 74.92 | 1120 | 2062.19 | 2180 | 3981.77 |
| 60 | 112.32 | 1140 | 2098.65 | 2200 | 4017.75 |
| 80 | 149.68 | 1160 | 2135.11 | 2220 | 4053.72 |
| 100 | 187.00 | 1180 | 2171.55 | 2240 | 4089.70 |
| 120 | 224.28 | 1200 | 2208.00 | 2260 | 4125.68 |
| 140 | 261.53 | 1220 | 2244.52 | 2280 | 4161.66 |
| 160 | 298.75 | 1240 | 2281.03 | 2300 | 4197.64 |
| 180 | 335.93 | 1260 | 2317.53 | 2320 | 4233.63 |
| 200 | 373.07 | 1280 | 2354.02 | 2340 | 4269.61 |
| 220 | 410.19 | 1300 | 2390.50 | 2360 | 4305.60 |
| 240 | 447.28 | 1320 | 2426.96 | 2380 | 4341.60 |
| 260 | 484.33 | 1340 | 2463.41 | 2400 | 4377.60 |
| 280 | 521.36 | 1360 | 2499.84 | 2420 | 4413.74 |
| 300 | 558.37 | 1380 | 2536.26 | 2440 | 4449.88 |
| 320 | 595.34 | 1400 | 2572.67 | 2460 | 4486.01 |
| 340 | 632.25 | 1420 | 2609.07 | 2480 | 4522.13 |
| 360 | 669.22 | 1440 | 2645.45 | 2500 | 4558.24 |
| 380 | 706.12 | 1460 | 2681.82 | 2520 | 4594.34 |
| 400 | 743.00 | 1480 | 2718.17 | 2540 | 4630.43 |
| 420 | 779.89 | 1500 | 2754.52 | 2560 | 4666.52 |
| 440 | 816.77 | 1520 | 2790.84 | 2580 | 4702.59 |
| 460 | 853.62 | 1540 | 2827.15 | 2600 | 4738.66 |
| 480 | 890.46 | 1560 | 2863.45 | 2620 | 4774.71 |
| 500 | 927.27 | 1580 | 2899.73 | 2640 | 4810.76 |
| 520 | 964.07 | 1600 | 2936.00 | 2660 | 4846.80 |
| 540 | 1000.85 | 1620 | 2972.17 | 2680 | 4882.83 |
| 560 | 1037.61 | 1640 | 3008.34 | 2700 | 4918.85 |
| 580 | 1074.36 | 1660 | 3044.50 | 2720 | 4954.86 |
| 600 | 1111.09 | 1680 | 3080.65 | 2740 | 4990.86 |
| 620 | 1147.80 | 1700 | 3116.79 | 2760 | 5026.84 |
| 640 | 1184.50 | 1720 | 3152.92 | 2780 | 5062.82 |
| 660 | 1221.18 | 1740 | 3189.05 | 2800 | 5098.80 |
| 680 | 1257.85 | 1760 | 3225.16 | 2820 | 5134.59 |
| 700 | 1294.51 | 1780 | 3261.27 | 2840 | 5170.39 |
| 720 | 1331.15 | 1800 | 3297.38 | 2860 | 5206.19 |
| 740 | 1367.78 | 1820 | 3333.47 | 2880 | 5242.00 |
| 760 | 1404.40 | 1840 | 3369.55 | 2900 | 5277.82 |
| 780 | 1441.00 | 1860 | 3405.63 | 2920 | 5313.64 |
| 800 | 1477.60 | 1880 | 3441.70 | 2940 | 5349.46 |
| 820 | 1514.21 | 1900 | 3477.77 | 2960 | 5385.30 |
| 840 | 1550.82 | 1920 | 3513.83 | 2980 | 5421.14 |
| 860 | 1587.41 | 1940 | 3549.88 | 3000 | 5457.00 |
| 880 | 1623.99 | 1960 | 3585.92 | 3020 | 5492.86 |
| 900 | 1660.56 | 1980 | 3621.96 | 3040 | 5528.72 |
| 920 | 1697.11 | 2000 | 3658.00 | 3060 | 5564.60 |
| 940 | 1733.66 | 2020 | 3693.98 | 3080 | 5600.48 |
| 960 | 1770.20 | 2040 | 3729.95 | 3100 | 5636.38 |
| 980 | 1806.73 | 2060 | 3765.93 | 3120 | 5672.28 |
| 1000 | 1843.25 | 2080 | 3801.91 | 3140 | 5708.19 |
| 1020 | 1879.76 | 2100 | 3837.88 | 3160 | 5744.12 |
| 1040 | 1916.26 | 2120 | 3873.85 | 3180 | 5780.05 |
| 1060 | 1952.75 | 2140 | 3909.83 | 3183 | 5785.58 |

NOTE

1672-3

●Fuel weight based on 6.70 pounds/gallon.

●For additional fuel information refer to Section 8.

**Figure 6-2 (Sheet 1 of 6)
WEIGHT AND MOMENT TABLE**

CREW, PASSENGERS AND CARGO COMPARTMENTS

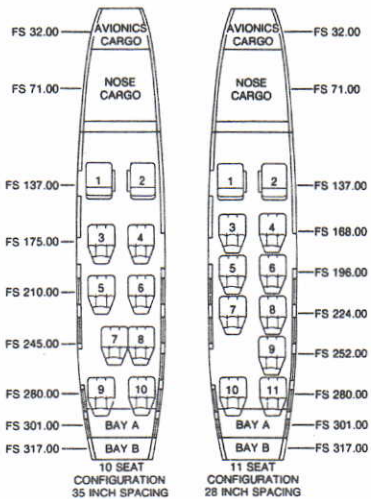
CREW AND PASSENGERS

| WEIGHT (POUNDS) | MOMENT/100 | | | | | | | | | |
|-----------------|----------------------------------|----------------------------------|----------------------------------|----------------------------------|-----------------------------------|----------------------------------|----------------------------------|----------------------------------|------------------------|------------------------------------|
| | SEAT 1 OR SEAT 2 ARM = FS 137.00 | 10 SEAT CONFIGURATION | | | | 11 SEAT CONFIGURATION | | | | |
| | | SEAT 3 OR SEAT 4 ARM = FS 175.00 | SEAT 5 OR SEAT 6 ARM = FS 210.00 | SEAT 7 OR SEAT 8 ARM = FS 245.00 | SEAT 9 OR SEAT 10 ARM = FS 280.00 | SEAT 3 OR SEAT 4 ARM = FS 188.00 | SEAT 5 OR SEAT 6 ARM = FS 196.00 | SEAT 7 OR SEAT 8 ARM = FS 224.00 | SEAT 9 ARM = FS 252.00 | SEAT 10 OR SEAT 11 ARM = FS 280.00 |
| 10 | 13.70 | 17.50 | 21.00 | 24.50 | 28.00 | 16.80 | 19.60 | 22.40 | 25.20 | 28.00 |
| 20 | 27.40 | 35.00 | 42.00 | 49.00 | 56.00 | 33.60 | 39.20 | 44.80 | 50.40 | 56.00 |
| 30 | 41.10 | 52.50 | 63.00 | 73.50 | 84.00 | 50.40 | 58.80 | 67.20 | 75.60 | 84.00 |
| 40 | 54.80 | 70.00 | 84.00 | 98.00 | 112.00 | 67.20 | 78.40 | 89.60 | 100.80 | 112.00 |
| 50 | 68.50 | 87.50 | 105.00 | 122.50 | 140.00 | 84.00 | 98.00 | 112.00 | 126.00 | 140.00 |
| 60 | 82.20 | 105.00 | 126.00 | 147.00 | 168.00 | 100.80 | 117.60 | 134.40 | 151.20 | 168.00 |
| 70 | 95.90 | 122.50 | 147.00 | 171.50 | 196.00 | 117.60 | 137.20 | 156.80 | 176.40 | 196.00 |
| 80 | 109.60 | 140.00 | 168.00 | 196.00 | 224.00 | 134.40 | 156.80 | 179.20 | 201.60 | 224.00 |
| 90 | 123.30 | 157.50 | 189.00 | 220.50 | 252.00 | 151.20 | 176.40 | 201.60 | 226.80 | 252.00 |
| 100 | 137.00 | 175.00 | 210.00 | 245.00 | 280.00 | 168.00 | 196.00 | 224.00 | 252.00 | 280.00 |
| 110 | 150.70 | 192.50 | 231.00 | 269.50 | 308.00 | 184.80 | 215.60 | 246.40 | 277.20 | 308.00 |
| 120 | 164.40 | 210.00 | 252.00 | 294.00 | 336.00 | 201.60 | 235.20 | 268.80 | 302.40 | 336.00 |
| 130 | 178.10 | 227.50 | 273.00 | 318.50 | 364.00 | 218.40 | 254.80 | 291.20 | 327.60 | 364.00 |
| 140 | 191.80 | 245.00 | 294.00 | 343.00 | 392.00 | 235.20 | 274.40 | 313.60 | 352.80 | 392.00 |
| 150 | 205.50 | 262.50 | 315.00 | 367.50 | 420.00 | 252.00 | 294.00 | 336.00 | 378.00 | 420.00 |
| 160 | 219.20 | 280.00 | 336.00 | 392.00 | 448.00 | 268.80 | 313.60 | 358.40 | 403.20 | 448.00 |
| 170 | 232.90 | 297.50 | 357.00 | 416.50 | 476.00 | 285.60 | 332.00 | 380.80 | 428.40 | 476.00 |
| 180 | 246.60 | 315.00 | 378.00 | 441.00 | 504.00 | 302.40 | 352.80 | 403.20 | 453.60 | 504.00 |
| 190 | 260.30 | 332.50 | 399.00 | 465.50 | 532.00 | 319.20 | 372.40 | 425.60 | 478.80 | 532.00 |
| 200 | 274.00 | 350.00 | 420.00 | 490.00 | 560.00 | 336.00 | 392.00 | 448.00 | 504.00 | 560.00 |
| 210 | 287.70 | 367.50 | 441.00 | 514.50 | 588.00 | 352.80 | 411.60 | 470.40 | 528.00 | 588.00 |
| 220 | 301.40 | 385.00 | 462.00 | 539.00 | 616.00 | 369.60 | 431.20 | 492.80 | 554.40 | 616.00 |
| 230 | 315.10 | 402.50 | 483.00 | 563.50 | 644.00 | 386.40 | 450.80 | 515.20 | 579.60 | 644.00 |
| 240 | 328.80 | 420.00 | 504.00 | 588.00 | 672.00 | 403.20 | 470.40 | 537.60 | 604.80 | 672.00 |
| 250 | 342.50 | 437.50 | 525.00 | 612.50 | 700.00 | 420.00 | 490.00 | 560.00 | 630.00 | 700.00 |
| 260 | 356.20 | 455.00 | 546.00 | 637.00 | 728.00 | 436.80 | 509.60 | 582.40 | 655.20 | 728.00 |
| 270 | 369.90 | 472.50 | 567.00 | 661.50 | 756.00 | 453.60 | 529.20 | 604.80 | 680.40 | 756.00 |
| 280 | 383.60 | 490.00 | 588.00 | 686.00 | 784.00 | 470.40 | 548.80 | 627.20 | 705.60 | 784.00 |
| 290 | 397.30 | 507.50 | 609.00 | 710.50 | 812.00 | 487.20 | 568.40 | 649.60 | 730.80 | 812.00 |
| 300 | 411.00 | 525.00 | 630.00 | 735.00 | 840.00 | 504.00 | 588.00 | 672.00 | 756.00 | 840.00 |

CARGO COMPARTMENTS CONTENTS

| WEIGHT (POUNDS) | MOMENT/100 | | | | |
|-----------------|-----------------------------|---------------------------------|------------------------------|-----------------------|-----------------------|
| | AVIONICS BAY ARM = FS 32.00 | NOSE COMPARTMENT ARM = FS 71.00 | WING LOCKERS ARM = FS 211.00 | AFT CABIN | |
| | | | | BAY A ARM = FS 301.00 | BAY B ARM = FS 317.00 |
| 10 | 3.20 | 7.10 | 21.10 | 30.10 | 31.70 |
| 20 | 6.40 | 14.20 | 42.20 | 60.20 | 63.40 |
| 30 | 9.60 | 21.30 | 63.30 | 90.30 | 95.10 |
| 40 | 12.80 | 28.40 | 84.40 | 120.40 | 126.80 |
| 50 | 16.00 | 35.50 | 105.50 | 150.50 | 158.50 |
| 60 | 19.20 | 42.60 | 126.60 | 180.60 | 190.20 |
| 70 | 22.40 | 49.70 | 147.70 | 210.70 | 221.90 |
| 80 | 25.60 | 56.80 | 168.80 | 240.80 | 253.60 |
| 90 | 28.80 | 63.90 | 189.90 | 270.90 | 285.30 |
| 100 | 32.00 | 71.00 | 211.00 | 301.00 | 317.00 |
| 110 | 35.20 | 78.10 | 232.10 | 331.10 | 348.70 |
| 120 | 38.40 | 85.20 | 253.20 | 361.20 | 380.40 |
| 130 | 41.60 | 92.30 | 274.30 | 391.30 | 412.10 |
| 140 | 44.80 | 99.40 | 295.40 | 421.40 | 443.80 |
| 150 | 48.00 | 106.50 | 316.50 | 451.50 | 475.50 |
| 160 | 51.20 | 113.60 | 337.60 | 481.60 | 507.20 |
| 170 | 54.40 | 120.70 | 358.70 | 511.70 | 538.90 |
| 180 | 57.60 | 127.80 | 379.80 | 541.80 | 570.60 |
| 190 | 60.80 | 134.90 | 400.90 | 571.90 | 602.30 |
| 200 | 64.00 | 142.00 | 422.00 | 602.00 | 634.00 |
| 210 | 67.20 | 149.10 | | 632.10 | 665.70 |
| 220 | 70.40 | 156.20 | | 662.20 | 697.40 |
| 230 | 73.60 | 163.30 | | 692.30 | 729.10 |
| 240 | 76.80 | 170.40 | | 722.40 | 760.80 |
| 250 | 80.00 | 177.50 | | 752.50 | 792.50 |
| 260 | | 184.60 | | 782.60 | 824.20 |
| 270 | | 191.70 | | 812.70 | 855.90 |
| 280 | | 198.80 | | 842.80 | 887.60 |
| 290 | | 205.90 | | 872.90 | 919.30 |
| 300 | | 213.00 | | 903.00 | 951.00 |
| 310 | | 220.10 | | 933.10 | 982.70 |
| 320 | | 227.20 | | 963.20 | 1014.40 |
| 330 | | 234.30 | | 993.30 | 1046.10 |
| 340 | | 241.40 | | 1023.40 | 1077.80 |
| 350 | | 248.50 | | 1053.50 | 1109.50 |
| 360 | | | | 1083.60 | 1141.20 |
| 370 | | | | 1113.70 | 1172.90 |
| 380 | | | | 1143.80 | 1204.60 |
| 390 | | | | 1173.90 | |
| 400 | | | | 1204.00 | |

CREW, PASSENGERS AND CARGO COMPARTMENTS MOMENT ARMS



1672-4A

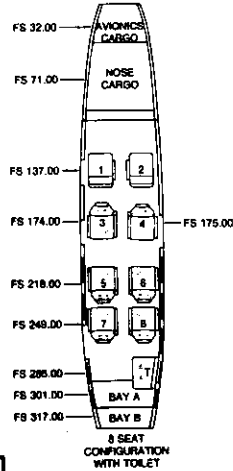
Figure 6-2 (Sheet 2 of 6)
WEIGHT AND MOMENT TABLE

CREW, PASSENGERS, CABINET AND CARGO COMPARTMENTS

CREW AND PASSENGERS

| WEIGHT (POUNDS) | MOMENT/100 | | | | | | | |
|-----------------|----------------------------------|------------------------|------------------------|----------------------------------|----------------------------------|------------------------|-----------------------------------|--|
| | SEAT 1 OR SEAT 2 ARM - FS 137.00 | SEAT 3 ARM - FS 174.00 | SEAT 4 ARM - FS 175.00 | SEAT 5 OR SEAT 6 ARM - FS 218.00 | SEAT 7 OR SEAT 8 ARM - FS 249.00 | TOILET ARM - FS 285.00 | SEAT 9 OR SEAT 10 ARM - FS 298.00 | |
| 10 | 13.70 | 17.40 | 17.50 | 21.80 | 24.90 | 28.50 | 29.80 | |
| 20 | 27.40 | 34.80 | 35.00 | 43.60 | 49.80 | 57.00 | 59.60 | |
| 30 | 41.10 | 52.20 | 52.50 | 65.40 | 74.70 | 85.50 | 89.40 | |
| 40 | 54.80 | 69.60 | 70.00 | 87.20 | 99.60 | 114.00 | 119.20 | |
| 50 | 68.50 | 87.00 | 87.50 | 109.00 | 124.50 | 142.50 | 149.60 | |
| 60 | 82.20 | 104.40 | 105.00 | 130.80 | 149.40 | 171.60 | 179.60 | |
| 70 | 95.90 | 121.80 | 122.50 | 152.60 | 174.30 | 199.50 | 208.40 | |
| 80 | 109.60 | 139.20 | 140.00 | 174.40 | 199.20 | 228.00 | 238.80 | |
| 90 | 123.30 | 156.60 | 157.50 | 196.20 | 224.10 | 256.50 | 268.40 | |
| 100 | 137.00 | 174.00 | 175.00 | 218.00 | 249.00 | 285.00 | 298.80 | |
| 110 | 150.70 | 191.40 | 192.50 | 239.80 | 273.90 | 313.50 | 328.80 | |
| 120 | 164.40 | 208.80 | 210.00 | 261.60 | 298.80 | 342.00 | 358.80 | |
| 130 | 178.10 | 226.20 | 227.50 | 283.40 | 323.70 | 370.50 | 389.60 | |
| 140 | 191.80 | 243.60 | 245.00 | 305.20 | 348.60 | 398.40 | 414.40 | |
| 150 | 205.50 | 261.00 | 262.50 | 327.00 | 373.50 | 427.50 | 444.00 | |
| 160 | 219.20 | 278.40 | 280.00 | 348.80 | 398.40 | 456.00 | 473.20 | |
| 170 | 232.90 | 295.80 | 297.50 | 370.60 | 423.30 | 484.50 | 502.00 | |
| 180 | 246.60 | 313.20 | 315.00 | 392.40 | 448.20 | 513.00 | 532.80 | |
| 190 | 260.30 | 330.60 | 332.50 | 414.20 | 473.10 | 541.50 | 562.40 | |
| 200 | 274.00 | 348.00 | 350.00 | 436.00 | 498.00 | 570.00 | 592.00 | |
| 210 | 287.70 | 365.40 | 367.50 | 457.80 | 522.90 | 598.50 | 621.60 | |
| 220 | 301.40 | 382.80 | 385.00 | 479.60 | 547.80 | 627.00 | 651.20 | |
| 230 | 315.10 | 400.20 | 402.50 | 501.40 | 572.70 | 655.50 | 680.80 | |
| 240 | 328.80 | 417.60 | 420.00 | 523.20 | 597.60 | 684.00 | 710.40 | |
| 250 | 342.50 | 435.00 | 437.50 | 545.00 | 622.50 | 712.50 | 740.00 | |
| 260 | 356.20 | 452.40 | 455.00 | 566.80 | 647.40 | 741.00 | 769.60 | |
| 270 | 369.90 | 469.80 | 472.50 | 588.60 | 672.30 | 769.50 | 799.20 | |
| 280 | 383.60 | 487.20 | 490.00 | 610.40 | 697.20 | 798.00 | 828.80 | |
| 290 | 397.30 | 504.60 | 507.50 | 632.20 | 722.10 | 826.50 | 858.40 | |
| 300 | 411.00 | 522.00 | 525.00 | 654.00 | 747.00 | 855.00 | 888.00 | |

CREW, PASSENGERS AND CARGO COMPARTMENTS MOMENT ARMS



CABINET AND CARGO COMPARTMENTS CONTENTS

| WEIGHT (POUNDS) | MOMENT/100 | | | | | | |
|-----------------|-----------------------------|---------------------------------|------------------------------|--|---------------------------------|-----------------------|-----------------------|
| | AVIONICS BAY ARM - FS 32.00 | NOSE COMPARTMENT ARM - FS 71.00 | WING LOCKERS ARM - FS 211.00 | FORWARD REFRESHMENT CENTER ARM - FS 162.00 | AFT CABIN FLOOR ARM - FS 281.00 | BAY A ARM - FS 301.00 | BAY B ARM - FS 317.00 |
| 10 | 3.20 | 7.10 | 21.10 | 16.20 | 28.10 | 30.10 | 31.70 |
| 20 | 6.40 | 14.20 | 42.20 | 32.40 | 56.20 | 60.20 | 63.40 |
| 30 | 9.60 | 21.30 | 63.30 | 48.60 | 84.30 | 90.30 | 95.10 |
| 40 | 12.80 | 28.40 | 84.40 | 64.80 | 112.40 | 120.40 | 126.80 |
| 50 | 16.00 | 35.50 | 105.50 | 81.00 | 140.50 | 150.50 | 158.90 |
| 60 | 19.20 | 42.60 | 126.60 | 97.20 | 168.60 | 180.60 | 190.20 |
| 70 | 22.40 | 49.70 | 147.70 | 113.40 | 196.70 | 210.70 | 221.90 |
| 80 | 25.60 | 56.80 | 168.80 | 129.60 | 224.80 | 240.80 | 253.80 |
| 90 | 28.80 | 63.90 | 189.90 | 145.80 | 252.90 | 270.90 | 285.30 |
| 100 | 32.00 | 71.00 | 211.00 | 162.00 | 281.00 | 301.00 | 317.00 |
| 110 | 35.20 | 78.10 | 232.10 | 178.20 | 309.10 | 331.10 | 344.00 |
| 120 | 38.40 | 85.20 | 253.20 | 194.40 | 337.20 | 361.20 | 381.60 |
| 130 | 41.60 | 92.30 | 274.30 | 210.60 | 365.30 | 391.30 | 419.20 |
| 140 | 44.80 | 99.40 | 295.40 | 226.80 | 393.40 | 421.40 | 457.80 |
| 150 | 48.00 | 106.50 | 316.50 | 243.00 | 421.50 | 451.50 | 496.40 |
| 160 | 51.20 | 113.60 | 337.60 | 259.20 | 449.60 | 481.60 | 535.00 |
| 170 | 54.40 | 120.70 | 358.70 | 275.40 | 477.70 | 511.70 | 573.60 |
| 180 | 57.60 | 127.80 | 379.80 | 291.60 | 505.80 | 541.80 | 612.20 |
| 190 | 60.80 | 134.90 | 400.90 | 307.80 | 533.90 | 571.90 | 650.80 |
| 200 | 64.00 | 142.00 | 422.00 | 324.00 | 562.00 | 602.00 | 689.40 |
| 210 | 67.20 | 149.10 | 443.10 | 340.20 | 590.10 | 632.10 | 728.00 |
| 220 | 70.40 | 156.20 | 464.20 | 356.40 | 618.20 | 662.20 | 766.60 |
| 230 | 73.60 | 163.30 | 485.30 | 372.60 | 646.30 | 692.30 | 805.20 |
| 240 | 76.80 | 170.40 | 506.40 | 388.80 | 674.40 | 722.40 | 843.80 |
| 250 | 80.00 | 177.50 | 527.50 | 405.00 | 702.50 | 752.50 | 882.40 |
| 260 | | 184.60 | 548.60 | 421.20 | 730.60 | 782.60 | 921.00 |
| 270 | | 191.70 | 569.70 | 437.40 | 758.70 | 812.70 | 959.60 |
| 280 | | 198.80 | 590.80 | 453.60 | 786.80 | 842.80 | 998.20 |
| 290 | | 205.90 | 611.90 | 469.80 | 814.90 | 872.90 | 1036.80 |
| 300 | | 213.00 | 633.00 | 486.00 | 843.00 | 903.00 | 1075.40 |
| 310 | | 220.10 | 654.10 | 502.20 | 871.10 | 933.10 | 1114.00 |
| 320 | | 227.20 | 675.20 | 518.40 | 899.20 | 963.20 | 1152.60 |
| 330 | | 234.30 | 696.30 | 534.60 | 927.30 | 993.30 | 1191.20 |
| 340 | | 241.40 | 717.40 | 550.80 | 955.40 | 1023.40 | 1229.80 |
| 350 | | 248.50 | 738.50 | 567.00 | 983.50 | 1053.50 | 1268.40 |
| 360 | | | 759.60 | 583.20 | 1011.60 | 1083.60 | 1307.00 |
| 370 | | | 780.70 | 599.40 | 1039.70 | 1113.70 | 1345.60 |
| 380 | | | 801.80 | 615.60 | 1067.80 | 1143.80 | 1384.20 |
| 390 | | | 822.90 | 631.80 | 1095.90 | 1173.90 | 1422.80 |
| 400 | | | 844.00 | 648.00 | 1124.00 | 1204.00 | 1461.40 |

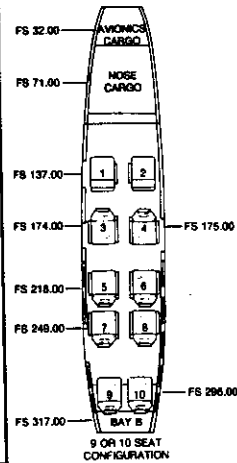


Figure 6-2 (Sheet 3 of 6)
WEIGHT AND MOMENT TABLE

**CREW, PASSENGERS, CABINET AND CARGO
COMPARTMENTS**

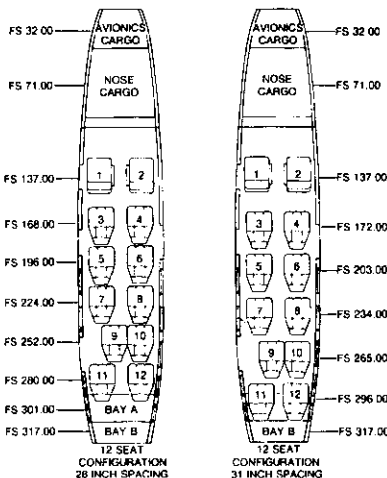
CREW AND PASSENGERS

| WEIGHT (POUNDS) | MOMENT/100 | | | | | | | | | | |
|-----------------|--------------------------------|--|--------------------------------|--------------------------------|---------------------------------|----------------------------------|--|--------------------------------|--------------------------------|---------------------------------|----------------------------------|
| | SEAT 1 OR SEAT 2 ARM FS 137.00 | OPTIONAL 28-INCH SEAT SPACING (ALL SEATS ON THE FLOOR) | | | | | OPTIONAL 31-INCH SEAT SPACING (AFT 2 SEATS ON 1ST SHELF) | | | | |
| | | SEAT 3 OR SEAT 4 ARM FS 188.00 | SEAT 5 OR SEAT 6 ARM FS 196.00 | SEAT 7 OR SEAT 8 ARM FS 224.00 | SEAT 9 OR SEAT 10 ARM FS 252.00 | SEAT 11 OR SEAT 12 ARM FS 280.00 | SEAT 3 OR SEAT 4 ARM FS 172.00 | SEAT 5 OR SEAT 6 ARM FS 203.00 | SEAT 7 OR SEAT 8 ARM FS 234.00 | SEAT 9 OR SEAT 10 ARM FS 265.00 | SEAT 11 OR SEAT 12 ARM FS 296.00 |
| 10 | 13.70 | 15.80 | 15.80 | 22.40 | 25.20 | 28.00 | 17.20 | 20.30 | 23.40 | 26.50 | 29.60 |
| 20 | 27.40 | 31.60 | 31.60 | 44.80 | 50.40 | 56.00 | 34.40 | 40.60 | 46.80 | 53.00 | 59.20 |
| 30 | 41.10 | 47.40 | 47.40 | 67.20 | 75.60 | 84.00 | 51.60 | 60.90 | 70.20 | 79.50 | 88.80 |
| 40 | 54.80 | 63.20 | 63.20 | 89.60 | 100.80 | 112.00 | 68.80 | 81.20 | 93.60 | 106.00 | 118.40 |
| 50 | 68.50 | 80.00 | 80.00 | 112.00 | 125.30 | 140.00 | 85.00 | 101.50 | 117.00 | 132.50 | 148.00 |
| 60 | 82.20 | 96.00 | 96.00 | 134.40 | 151.20 | 168.00 | 101.20 | 121.80 | 140.40 | 159.00 | 177.60 |
| 70 | 95.90 | 112.00 | 112.00 | 156.80 | 176.40 | 196.00 | 117.40 | 142.10 | 163.80 | 185.50 | 207.20 |
| 80 | 109.60 | 128.00 | 128.00 | 179.20 | 201.60 | 224.00 | 133.60 | 162.40 | 187.20 | 212.00 | 236.80 |
| 90 | 123.30 | 144.00 | 144.00 | 201.60 | 226.80 | 252.00 | 150.00 | 182.70 | 210.50 | 238.50 | 266.40 |
| 100 | 137.00 | 160.00 | 160.00 | 224.00 | 252.00 | 280.00 | 166.40 | 203.00 | 234.00 | 265.00 | 296.00 |
| 110 | 150.70 | 176.00 | 176.00 | 246.40 | 277.20 | 308.00 | 182.80 | 223.30 | 257.40 | 291.50 | 325.60 |
| 120 | 164.40 | 192.00 | 192.00 | 268.80 | 302.40 | 336.00 | 200.00 | 243.60 | 280.80 | 318.00 | 352.00 |
| 130 | 178.10 | 208.00 | 208.00 | 291.20 | 327.60 | 364.00 | 216.40 | 263.90 | 304.20 | 344.50 | 384.00 |
| 140 | 191.80 | 224.00 | 224.00 | 313.60 | 352.80 | 392.00 | 232.80 | 284.20 | 327.60 | 371.00 | 414.40 |
| 150 | 205.50 | 240.00 | 240.00 | 336.00 | 378.00 | 420.00 | 249.20 | 304.50 | 351.00 | 397.50 | 444.00 |
| 160 | 219.20 | 256.00 | 256.00 | 358.40 | 403.20 | 448.00 | 265.60 | 324.80 | 374.40 | 424.00 | 473.60 |
| 170 | 232.90 | 272.00 | 272.00 | 380.80 | 428.40 | 476.00 | 282.00 | 345.10 | 397.80 | 450.50 | 503.20 |
| 180 | 246.60 | 288.00 | 288.00 | 403.20 | 453.60 | 504.00 | 298.40 | 365.40 | 421.20 | 477.00 | 532.80 |
| 190 | 260.30 | 304.00 | 304.00 | 425.60 | 478.80 | 532.00 | 314.80 | 385.70 | 444.60 | 503.50 | 562.40 |
| 200 | 274.00 | 320.00 | 320.00 | 448.00 | 504.00 | 560.00 | 331.20 | 406.00 | 468.00 | 530.00 | 592.00 |
| 210 | 287.70 | 336.00 | 336.00 | 470.40 | 529.20 | 588.00 | 347.60 | 426.30 | 491.40 | 558.50 | 621.60 |
| 220 | 301.40 | 352.00 | 352.00 | 492.80 | 554.40 | 616.00 | 364.00 | 446.60 | 514.80 | 585.00 | 651.20 |
| 230 | 315.10 | 368.00 | 368.00 | 515.20 | 579.60 | 644.00 | 380.40 | 466.90 | 538.20 | 609.50 | 680.80 |
| 240 | 328.80 | 384.00 | 384.00 | 537.60 | 604.80 | 672.00 | 396.80 | 487.20 | 561.60 | 636.00 | 710.40 |
| 250 | 342.50 | 400.00 | 400.00 | 560.00 | 630.00 | 700.00 | 413.20 | 507.50 | 585.00 | 662.50 | 740.00 |
| 260 | 356.20 | 416.00 | 416.00 | 582.40 | 655.20 | 728.00 | 429.60 | 527.80 | 608.40 | 689.00 | 760.80 |
| 270 | 369.90 | 432.00 | 432.00 | 604.80 | 680.40 | 756.00 | 446.00 | 548.10 | 631.80 | 715.50 | 792.00 |
| 280 | 383.60 | 448.00 | 448.00 | 627.20 | 705.60 | 784.00 | 462.40 | 568.40 | 655.20 | 742.00 | 824.00 |
| 290 | 397.30 | 464.00 | 464.00 | 649.60 | 730.80 | 812.00 | 478.80 | 588.70 | 678.60 | 768.50 | 844.00 |
| 300 | 411.00 | 480.00 | 480.00 | 672.00 | 756.00 | 840.00 | 495.20 | 609.00 | 702.00 | 795.00 | 888.00 |

CARGO COMPARTMENTS CONTENTS

| WEIGHT (POUNDS) | MOMENT/100 | | | |
|-----------------|-----------------------------|---------------------------------|------------------------------|---------|
| | AVIONICS BAY ARM - FS 32.00 | NOSE COMPARTMENT ARM - FS 71.00 | WING LOCKERS ARM - FS 211.00 | CABIN |
| 10 | 3.20 | 7.10 | 21.10 | 30.10 |
| 20 | 6.40 | 14.20 | 42.20 | 60.20 |
| 30 | 9.60 | 21.30 | 63.30 | 90.30 |
| 40 | 12.80 | 28.40 | 84.40 | 120.40 |
| 50 | 16.00 | 35.50 | 105.50 | 150.50 |
| 60 | 19.20 | 42.60 | 126.60 | 180.60 |
| 70 | 22.40 | 49.70 | 147.70 | 210.70 |
| 80 | 25.60 | 56.80 | 168.80 | 240.80 |
| 90 | 28.80 | 63.90 | 189.90 | 270.90 |
| 100 | 32.00 | 71.00 | 211.00 | 301.00 |
| 110 | 35.20 | 78.10 | 232.10 | 331.10 |
| 120 | 38.40 | 85.20 | 253.20 | 361.20 |
| 130 | 41.60 | 92.30 | 274.30 | 391.30 |
| 140 | 44.80 | 99.40 | 295.40 | 421.40 |
| 150 | 48.00 | 106.50 | 316.50 | 451.50 |
| 160 | 51.20 | 113.60 | 337.60 | 481.60 |
| 170 | 54.40 | 120.70 | 358.70 | 511.70 |
| 180 | 57.60 | 127.80 | 379.80 | 541.80 |
| 190 | 60.80 | 134.90 | 400.90 | 571.90 |
| 200 | 64.00 | 142.00 | 422.00 | 602.00 |
| 210 | 67.20 | 149.10 | 443.10 | 632.10 |
| 220 | 70.40 | 156.20 | 464.20 | 662.20 |
| 230 | 73.60 | 163.30 | 485.30 | 692.30 |
| 240 | 76.80 | 170.40 | 506.40 | 722.40 |
| 250 | 80.00 | 177.50 | 527.50 | 752.50 |
| 260 | | 184.60 | 548.60 | 782.60 |
| 270 | | 191.70 | 569.70 | 812.70 |
| 280 | | 198.80 | 590.80 | 842.80 |
| 290 | | 205.90 | 611.90 | 872.90 |
| 300 | | 213.00 | 633.00 | 903.00 |
| 310 | | 220.10 | 654.10 | 933.10 |
| 320 | | 227.20 | 675.20 | 963.20 |
| 330 | | 234.30 | 696.30 | 993.30 |
| 340 | | 241.40 | 717.40 | 1023.40 |
| 350 | | 248.50 | 738.50 | 1053.50 |
| 360 | | | 759.60 | 1083.60 |
| 370 | | | 780.70 | 1113.70 |
| 380 | | | 801.80 | 1143.80 |
| 390 | | | 822.90 | 1173.90 |
| 400 | | | 844.00 | 1204.00 |

CREW, PASSENGER AND CARGO COMPARTMENTS MOMENT ARMS



**Figure 6-2 (Sheet 4 of 6)
WEIGHT AND MOMENT TABLE**

CREW, PASSENGERS, CABINET AND CARGO COMPARTMENTS

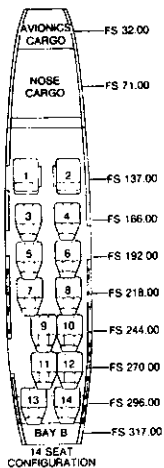
CREW AND PASSENGERS

| WEIGHT (POUNDS) | MOMENT/100 | | | | | | |
|--------------------|---------------------------------|---------------------------------|---|---|--|---|---|
| | SEAT 1 OR ARM - FS 137.00 | SEAT 3 OR ARM - FS 166.00 | SEAT 5 OR SEAT 6 ARM - FS 192.00 | SEAT 7 OR SEAT 8 ARM - FS 218.00 | SEAT 9 OR SEAT 10 ARM - FS 244.00 | SEAT 11 OR SEAT 12 ARM - FS 270.00 | SEAT 13 OR SEAT 14 ARM - FS 296.00 |
| 10 | 13.70 | 16.60 | 19.20 | 21.80 | 24.40 | 27.00 | 29.60 |
| 20 | 27.40 | 33.20 | 38.40 | 43.60 | 48.80 | 54.00 | 59.20 |
| 30 | 41.10 | 49.80 | 57.60 | 65.40 | 73.20 | 81.00 | 88.80 |
| 40 | 54.80 | 66.40 | 76.80 | 87.20 | 97.60 | 108.00 | 118.40 |
| 50 | 68.50 | 83.00 | 96.00 | 109.00 | 122.00 | 135.00 | 148.00 |
| 60 | 82.20 | 99.60 | 115.20 | 130.80 | 148.40 | 162.00 | 177.60 |
| 70 | 95.90 | 116.20 | 134.40 | 152.60 | 170.80 | 189.00 | 207.20 |
| 80 | 109.60 | 132.80 | 153.60 | 174.40 | 195.20 | 216.00 | 236.80 |
| 90 | 123.30 | 149.40 | 172.80 | 196.20 | 219.60 | 243.00 | 266.40 |
| 100 | 137.00 | 166.00 | 192.00 | 218.00 | 244.00 | 270.00 | 296.00 |
| 110 | 150.70 | 182.60 | 211.20 | 239.80 | 268.40 | 297.00 | 325.60 |
| 120 | 164.40 | 199.20 | 230.40 | 261.60 | 292.80 | 324.00 | 355.20 |
| 130 | 178.10 | 215.80 | 249.60 | 283.40 | 317.20 | 351.00 | 384.80 |
| 140 | 191.80 | 232.40 | 268.80 | 305.20 | 341.60 | 378.00 | 414.40 |
| 150 | 205.50 | 249.00 | 288.00 | 327.00 | 366.00 | 405.00 | 444.00 |
| 160 | 219.20 | 265.60 | 307.20 | 348.80 | 390.40 | 432.00 | 473.60 |
| 170 | 232.90 | 282.20 | 326.40 | 370.60 | 414.80 | 459.00 | 503.20 |
| 180 | 246.60 | 298.80 | 345.60 | 392.40 | 439.20 | 486.00 | 532.80 |
| 190 | 260.30 | 315.40 | 364.80 | 414.20 | 463.60 | 513.00 | 562.40 |
| 200 | 274.00 | 332.00 | 384.00 | 436.00 | 488.00 | 540.00 | 592.00 |
| 210 | 287.70 | 348.60 | 403.20 | 457.80 | 512.40 | 567.00 | 621.60 |
| 220 | 301.40 | 365.20 | 422.40 | 479.60 | 536.80 | 594.00 | 651.20 |
| 230 | 315.10 | 381.80 | 441.60 | 501.40 | 561.20 | 621.00 | 680.80 |
| 240 | 328.80 | 398.40 | 460.80 | 523.20 | 585.60 | 648.00 | 710.40 |
| 250 | 342.50 | 415.00 | 480.00 | 545.00 | 610.00 | 675.00 | 740.00 |
| 260 | 356.20 | 431.60 | 499.20 | 566.80 | 634.40 | 702.00 | 769.60 |
| 270 | 369.90 | 448.20 | 518.40 | 588.60 | 658.80 | 729.00 | 799.20 |
| 280 | 383.60 | 464.80 | 537.60 | 610.40 | 683.20 | 756.00 | 828.80 |
| 290 | 397.30 | 481.40 | 556.80 | 632.20 | 707.60 | 783.00 | 858.40 |
| 300 | 411.00 | 498.00 | 576.00 | 654.00 | 732.00 | 810.00 | 888.00 |

CARGO COMPARTMENTS CONTENTS

| WEIGHT (POUNDS) | MOMENT/100 | | | |
|--------------------|------------------------------------|--|-------------------------------------|--|
| | AVIONICS BAY ARM FS 32.00 | NOSE COMPARTMENT ARM FS 71.00 | WING LOCKERS ARM FS 211.00 | AFT CABIN BAY B ARM FS 317.00 |
| 10 | 3.20 | 7.10 | 21.10 | 31.70 |
| 20 | 6.40 | 14.20 | 42.20 | 63.40 |
| 30 | 9.60 | 21.30 | 63.30 | 95.10 |
| 40 | 12.80 | 28.40 | 84.40 | 126.80 |
| 50 | 16.00 | 35.50 | 105.50 | 158.50 |
| 60 | 19.20 | 42.60 | 126.60 | 190.20 |
| 70 | 22.40 | 49.70 | 147.70 | 221.90 |
| 80 | 25.60 | 56.80 | 168.80 | 253.60 |
| 90 | 28.80 | 63.90 | 189.90 | 285.30 |
| 100 | 32.00 | 71.00 | 211.00 | 317.00 |
| 110 | 35.20 | 78.10 | 232.10 | 348.70 |
| 120 | 38.40 | 85.20 | 253.20 | 380.40 |
| 130 | 41.60 | 92.30 | 274.30 | 412.10 |
| 140 | 44.80 | 99.40 | 295.40 | 443.80 |
| 150 | 48.00 | 106.50 | 316.50 | 475.50 |
| 160 | 51.20 | 113.60 | 337.60 | 507.20 |
| 170 | 54.40 | 120.70 | 358.70 | 538.90 |
| 180 | 57.60 | 127.80 | 379.80 | 570.60 |
| 190 | 60.80 | 134.90 | 400.90 | 602.30 |
| 200 | 64.00 | 142.00 | 422.00 | 634.00 |
| 210 | 67.20 | 149.10 | 443.10 | 665.70 |
| 220 | 70.40 | 156.20 | 464.20 | 697.40 |
| 230 | 73.60 | 163.30 | 485.30 | 729.10 |
| 240 | 76.80 | 170.40 | 506.40 | 760.80 |
| 250 | 80.00 | 177.50 | 527.50 | 792.50 |
| 260 | | 184.60 | 548.60 | 824.20 |
| 270 | | 191.70 | 569.70 | 855.90 |
| 280 | | 198.80 | 590.80 | 887.60 |
| 290 | | 205.90 | 611.90 | 919.30 |
| 300 | | 213.00 | 633.00 | 951.00 |
| 310 | | 220.10 | 654.10 | 982.70 |
| 320 | | 227.20 | 675.20 | 1014.40 |
| 330 | | 234.30 | 696.30 | 1046.10 |
| 340 | | 241.40 | 717.40 | 1077.80 |
| 350 | | 248.50 | 738.50 | 1109.50 |
| 360 | | | | |
| 370 | | | | |
| 380 | | | | |
| 390 | | | | |
| 400 | | | | |

CREW, PASSENGER AND CARGO COMPARTMENTS MOMENT ARMS



1672-4E

**Figure 6-2 (Sheet 5 of 6)
WEIGHT AND MOMENT TABLE**

CREW AND CARGO COMPARTMENTS

CARGO COMPARTMENTS CONTENTS

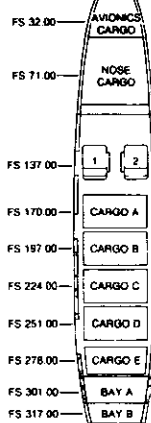
| WEIGHT (POUNDS) | MOMENT/100 | | | | |
|-----------------|---------------------------|---------------------------|---------------------------|---------------------------|---------------------------|
| | CARGO 'A' ARM - FS 170.00 | CARGO 'B' ARM - FS 187.00 | CARGO 'C' ARM - FS 224.00 | CARGO 'D' ARM - FS 251.00 | CARGO 'E' ARM - FS 278.00 |
| 10 | 17.00 | 18.70 | 22.40 | 25.10 | 27.80 |
| 20 | 34.00 | 36.40 | 44.80 | 50.20 | 55.60 |
| 30 | 51.00 | 54.60 | 67.20 | 75.30 | 83.40 |
| 40 | 68.00 | 72.80 | 89.60 | 100.40 | 111.20 |
| 50 | 85.00 | 89.60 | 112.00 | 125.50 | 139.00 |
| 60 | 102.00 | 113.20 | 134.40 | 150.60 | 166.80 |
| 70 | 119.00 | 127.80 | 156.80 | 175.70 | 194.60 |
| 80 | 136.00 | 142.40 | 179.20 | 200.80 | 222.40 |
| 90 | 153.00 | 157.00 | 201.60 | 225.90 | 250.20 |
| 100 | 170.00 | 171.60 | 224.00 | 251.00 | 278.00 |
| 110 | 187.00 | 186.20 | 246.40 | 276.10 | 305.80 |
| 120 | 204.00 | 200.80 | 268.80 | 301.20 | 333.60 |
| 130 | 221.00 | 215.40 | 291.20 | 326.30 | 361.40 |
| 140 | 238.00 | 230.00 | 313.60 | 351.40 | 389.20 |
| 150 | 255.00 | 244.60 | 336.00 | 376.50 | 417.00 |
| 160 | 272.00 | 259.20 | 358.40 | 401.60 | 444.80 |
| 170 | 289.00 | 273.80 | 380.80 | 426.70 | 472.60 |
| 180 | 306.00 | 288.40 | 403.20 | 451.80 | 500.40 |
| 190 | 323.00 | 303.00 | 425.60 | 476.90 | 528.20 |
| 200 | 340.00 | 317.60 | 448.00 | 502.00 | 556.00 |
| 210 | 357.00 | 332.20 | 470.40 | 527.10 | 583.80 |
| 220 | 374.00 | 346.80 | 492.80 | 552.20 | 611.60 |
| 230 | 391.00 | 361.40 | 515.20 | 577.30 | 639.40 |
| 240 | 408.00 | 376.00 | 537.60 | 602.40 | 667.20 |
| 250 | 425.00 | 390.60 | 560.00 | 627.50 | 695.00 |
| 260 | 442.00 | 405.20 | 582.40 | 652.60 | 722.80 |
| 270 | 459.00 | 419.80 | 604.80 | 677.70 | 750.60 |
| 280 | 476.00 | 434.40 | 627.20 | 702.80 | 778.40 |
| 290 | 493.00 | 449.00 | 649.60 | 727.90 | 806.20 |
| 300 | 510.00 | 463.60 | 672.00 | 753.00 | 834.00 |
| 310 | 527.00 | 478.20 | 694.40 | 778.10 | 861.80 |
| 320 | 544.00 | 492.80 | 716.80 | 803.20 | 889.60 |
| 330 | 561.00 | 507.40 | 739.20 | 828.30 | 917.40 |
| 340 | 578.00 | 522.00 | 761.60 | 853.40 | 945.20 |
| 350 | 595.00 | 536.60 | 784.00 | 878.50 | 973.00 |
| 360 | 612.00 | 551.20 | 806.40 | 903.60 | 1000.80 |
| 370 | 629.00 | 565.80 | 828.80 | 928.70 | 1028.60 |
| 380 | 646.00 | 580.40 | 851.20 | 953.80 | 1056.40 |
| 390 | 663.00 | 595.00 | 873.60 | 978.90 | 1084.20 |
| 400 | 680.00 | 609.60 | 896.00 | 1004.00 | 1112.00 |
| 410 | 697.00 | 624.20 | 918.40 | 1029.10 | 1139.80 |
| 420 | 714.00 | 638.80 | 940.80 | 1054.20 | 1167.60 |
| 430 | 731.00 | 653.40 | 963.20 | 1079.30 | 1195.40 |
| 440 | 748.00 | 668.00 | 985.60 | 1104.40 | 1223.20 |
| 450 | 765.00 | 682.60 | 1008.00 | 1129.50 | 1251.00 |
| 460 | 782.00 | 697.20 | 1030.40 | 1154.60 | 1278.80 |
| 470 | 799.00 | 711.80 | 1052.80 | 1179.70 | 1306.60 |
| 480 | 816.00 | 726.40 | 1075.20 | 1204.80 | 1334.40 |
| 490 | 833.00 | 741.00 | 1097.60 | 1229.90 | 1362.20 |
| 500 | 850.00 | 755.60 | 1120.00 | 1255.00 | 1390.00 |
| 510 | 867.00 | 770.20 | 1142.40 | 1280.10 | 1417.80 |
| 520 | 884.00 | 784.80 | 1164.80 | 1305.20 | 1445.60 |
| 530 | 901.00 | 799.40 | 1187.20 | 1330.30 | 1473.40 |
| 540 | 918.00 | 814.00 | 1209.60 | 1355.40 | 1501.20 |
| 550 | 935.00 | 828.60 | 1232.00 | 1380.50 | 1529.00 |
| 560 | 952.00 | 843.20 | 1254.40 | 1405.60 | 1556.80 |
| 570 | 969.00 | 857.80 | 1276.80 | 1430.70 | 1584.60 |
| 580 | 986.00 | 872.40 | 1299.20 | 1455.80 | 1612.40 |
| 590 | 1003.00 | 887.00 | 1321.60 | 1480.90 | 1640.20 |
| 600 | 1020.00 | 901.60 | 1344.00 | 1506.00 | 1668.00 |

CARGO COMPARTMENTS CONTENTS

| WEIGHT (POUNDS) | MOMENT/100 | | | |
|-----------------|-----------------------------|---------------------------------|------------------------------|---------------------------------|
| | AVIONICS BAY ARM - FS 32.00 | NOSE COMPARTMENT ARM - FS 71.00 | WING LOCKERS ARM - FS 211.00 | AFT CABIN BAY A ARM - FS 301.00 |
| 10 | 3.20 | 7.10 | 21.10 | 30.10 |
| 20 | 6.40 | 14.20 | 42.20 | 60.20 |
| 30 | 9.60 | 21.30 | 63.30 | 90.30 |
| 40 | 12.80 | 28.40 | 84.40 | 120.40 |
| 50 | 16.00 | 35.50 | 105.50 | 150.50 |
| 60 | 19.20 | 42.60 | 126.60 | 180.60 |
| 70 | 22.40 | 49.70 | 147.70 | 210.70 |
| 80 | 25.60 | 56.80 | 168.80 | 240.80 |
| 90 | 28.80 | 63.90 | 189.90 | 270.90 |
| 100 | 32.00 | 71.00 | 211.00 | 301.00 |
| 110 | 35.20 | 78.10 | 232.10 | 331.10 |
| 120 | 38.40 | 85.20 | 253.20 | 361.20 |
| 130 | 41.60 | 92.30 | 274.30 | 391.30 |
| 140 | 44.80 | 99.40 | 295.40 | 421.40 |
| 150 | 48.00 | 106.50 | 316.50 | 451.50 |
| 160 | 51.20 | 113.60 | 337.60 | 481.60 |
| 170 | 54.40 | 120.70 | 358.70 | 511.70 |
| 180 | 57.60 | 127.80 | 379.80 | 541.80 |
| 190 | 60.80 | 134.90 | 400.90 | 571.90 |
| 200 | 64.00 | 142.00 | 422.00 | 602.00 |
| 210 | 67.20 | 149.10 | 443.10 | 632.10 |
| 220 | 70.40 | 156.20 | 464.20 | 662.20 |
| 230 | 73.60 | 163.30 | 485.30 | 692.30 |
| 240 | 76.80 | 170.40 | 506.40 | 722.40 |
| 250 | 80.00 | 177.50 | 527.50 | 752.50 |
| 260 | 83.20 | 184.60 | 548.60 | 782.60 |
| 270 | 86.40 | 191.70 | 569.70 | 812.70 |
| 280 | 89.60 | 198.80 | 590.80 | 842.80 |
| 290 | 92.80 | 205.90 | 611.90 | 872.90 |
| 300 | 96.00 | 213.00 | 633.00 | 903.00 |
| 310 | 99.20 | 220.10 | 654.10 | 933.10 |
| 320 | 102.40 | 227.20 | 675.20 | 963.20 |
| 330 | 105.60 | 234.30 | 696.30 | 993.30 |
| 340 | 108.80 | 241.40 | 717.40 | 1023.40 |
| 350 | 112.00 | 248.50 | 738.50 | 1053.50 |
| 360 | 115.20 | 255.60 | 759.60 | 1083.60 |
| 370 | 118.40 | 262.70 | 780.70 | 1113.70 |
| 380 | 121.60 | 269.80 | 801.80 | 1143.80 |
| 390 | 124.80 | 276.90 | 822.90 | 1173.90 |
| 400 | 128.00 | 284.00 | 844.00 | 1204.00 |

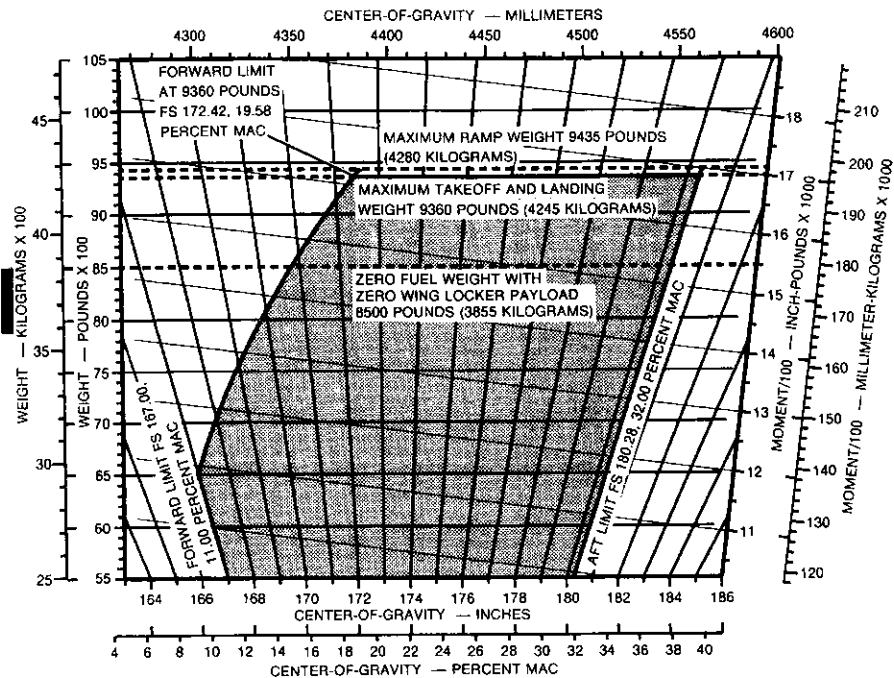
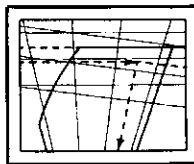
CREW AND CARGO COMPARTMENTS MOMENT ARMS

| WEIGHT (POUNDS) | MOMENT/100 | |
|-----------------|----------------------------------|--|
| | SEAT 1 OR SEAT 2 ARM - FS 137.00 | |
| 10 | 13.70 | |
| 20 | 27.40 | |
| 30 | 41.10 | |
| 40 | 54.80 | |
| 50 | 68.50 | |
| 60 | 82.20 | |
| 70 | 95.90 | |
| 80 | 109.60 | |
| 90 | 123.30 | |
| 100 | 137.00 | |
| 110 | 150.70 | |
| 120 | 164.40 | |
| 130 | 178.10 | |
| 140 | 191.80 | |
| 150 | 205.50 | |
| 160 | 219.20 | |
| 170 | 232.90 | |
| 180 | 246.60 | |
| 190 | 260.30 | |
| 200 | 274.00 | |
| 210 | 287.70 | |
| 220 | 301.40 | |
| 230 | 315.10 | |
| 240 | 328.80 | |
| 250 | 342.50 | |
| 260 | 356.20 | |
| 270 | 369.90 | |
| 280 | 383.60 | |
| 290 | 397.30 | |
| 300 | 411.00 | |



1672-4C

Figure 6-2 (Sheet 6 of 6)
WEIGHT AND MOMENT TABLE



1672-2

Figure 6-3
CENTER-OF-GRAVITY LIMITS ENVELOPE GRAPH

MODEL 406

SECTION 6 WEIGHT AND BALANCE

| FUSELAGE PAYLOAD COMPUTATIONS | | | | ITEM | WEIGHT (POUNDS) | MOMENT/100 |
|-------------------------------|--------|-----------------|------------|---|-----------------|------------|
| ITEM | ARM | WEIGHT (POUNDS) | MOMENT/100 | | | |
| | | | | 1. BASIC EMPTY WEIGHT * Airplane CG = 171.19 | 5190 | 8884.59 |
| OCCUPANTS | | | | 2. FUSELAGE PAYLOAD | 1600 | 2793.60 |
| SEAT 1 | 137.00 | 170 | 232.90 | 3. ZERO FUEL WEIGHT WITH ZERO WING LOCKER PAYLOAD (sub-total) (Do not exceed weight limit of 8500 pounds) | 6790 | 11,678.19 |
| SEAT 2 | 137.00 | 170 | 232.90 | | | |
| SEAT 3 | 178.00 | 170 | 302.60 | 4. WING LOCKER PAYLOAD | 200 | 422.00 |
| SEAT 4 | 178.00 | 170 | 302.60 | | | |
| SEAT 5 | 218.00 | 170 | 370.60 | 5. FUEL LOADING | 1240 | 2281.03 |
| SEAT 6 | 218.00 | 170 | 370.60 | | | |
| SEAT 7 | 249.00 | 170 | 423.30 | 6. RAMP WEIGHT (sub-total) (Do not exceed maximum ramp weight of 9435 pounds) | 8230 | 14,381.22 |
| SEAT 8 | 249.00 | 150 | 373.50 | | | |
| SEAT 9 | | | | 7. LESS FUEL FOR TAXIING | -60 | -109.48 |
| SEAT 10 | | | | | | |
| SEAT 11 | | | | 8. **TAKEOFF WEIGHT (Do not exceed maximum takeoff weight of 9360 pounds) * Airplane CG = 173.77 *** | 8170 | 14,271.74 |
| SEAT 12 | | | | | | |
| SEAT 13 | | | | 9. LESS FUEL TO DESTINATION | -800 | -1465.43 |
| SEAT 14 | | | | | | |
| CARGO | | | | 10. **LANDING WEIGHT (Do not exceed maximum landing weight of 9360 pounds) * Airplane CG = 172.72 *** | 7370 | 12,806.31 |
| AVIONICS | 32.00 | 260 | 184.60 | | | |
| NOSE | 71.00 | | | | | |
| CARGO A | 170.00 | | | * Airplane CG = $\frac{\text{MOMENT}/100}{\text{WEIGHT}} \times 100$ | | |
| CARGO B | 197.00 | | | ** Totals must be within approved weight and center-of-gravity limits. It is the responsibility of the operator to ensure that the airplane is loaded properly. The Basic Empty Weight CG is noted on the Airplane Weighing Form. If the airplane has been altered, refer to the Weight and Balance Record for information. | | |
| CARGO C | 224.00 | | | *** Enter on the Center-of-Gravity Limits Envelope Graph to check if within approved limits (shaded area). | | |
| CARGO D | 251.00 | | | | | |
| CARGO E | 278.00 | | | | | |
| AFT CABIN FLOOR | 281.00 | | | | | |
| BAY A | 301.00 | | | | | |
| BAY B | 317.00 | | | | | |
| CABINET CONTENTS | | | | | | |
| FUSELAGE PAYLOAD | | | | | 1600 | 2793.60 |

1672-6

**Figure 6-4
SAMPLE WEIGHT AND BALANCE COMPUTATION FORM**

(CONTINUOUS HISTORY OF CHANGES IN STRUCTURE MODIFICATION
OR EQUIPMENT AFFECTING WEIGHT AND BALANCE)

| DATE | ITEM | | DESCRIPTION OF STRUCTURE MODIFICATION OR EQUIPMENT | WEIGHT CHANGE | | | | | | BASIC EMPTY WEIGHT | |
|------|------|-----|---|--------------------|-----------------|----------------|--------------------|-----------------|----------------|--------------------------|----------------|
| | | | | ADDED (+) | | | REMOVED (-) | | | WEIGHT (POUNDS) | MOMENT /100 |
| | | | | WEIGHT (POUNDS) | ARM (INCHES) | MOMENT /100 | WEIGHT (POUNDS) | ARM (INCHES) | MOMENT /100 | | |
| | IN | OUT | | | | | | | | | |

1650

**Figure 6-5
WEIGHT AND BALANCE RECORD**

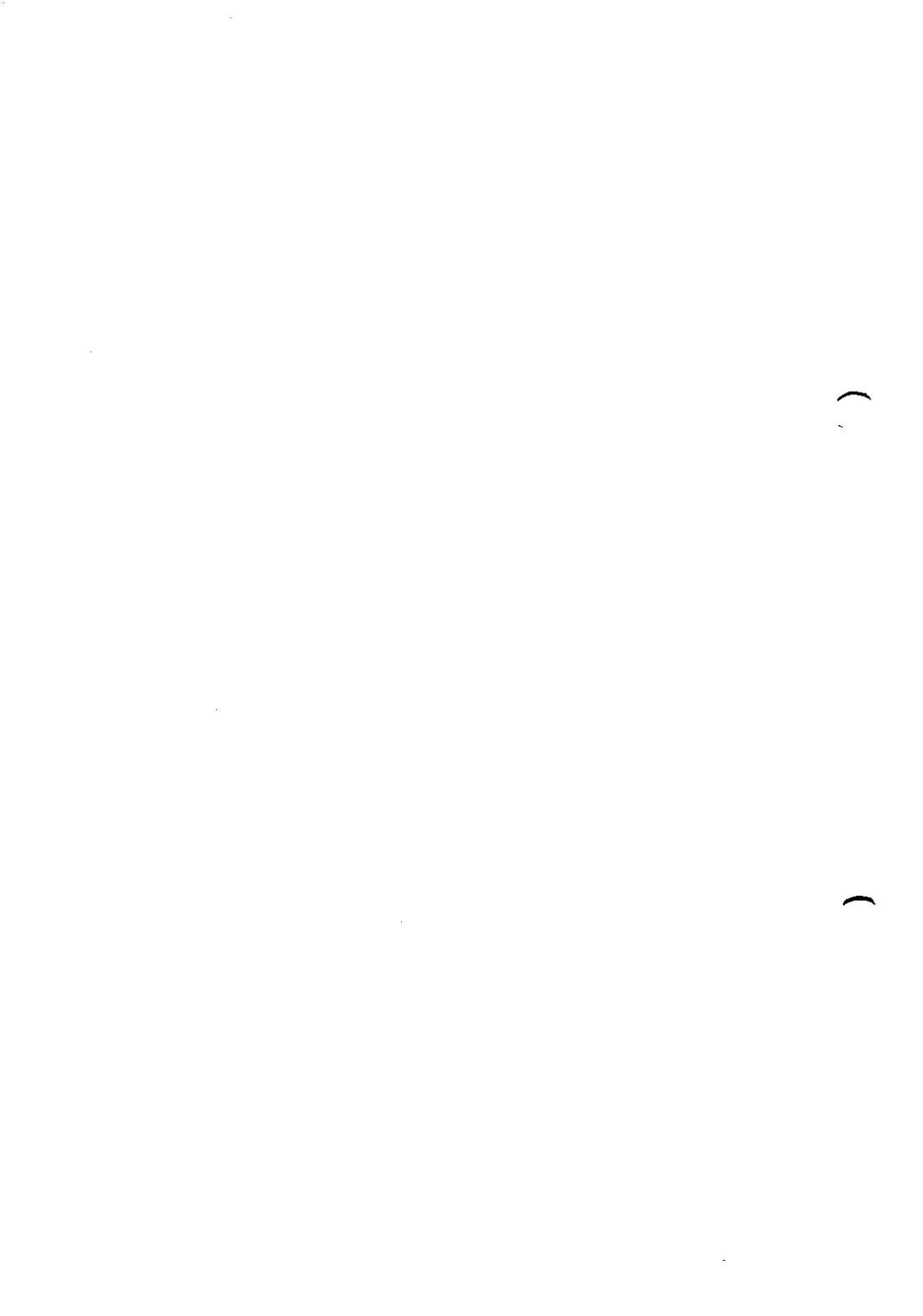
EQUIPMENT LIST

For a complete list of the required and optional equipment installed in the airplane as delivered from the manufacturer, refer to the equipment list furnished with the airplane.

WEIGHT AND BALANCE
COMPUTATION FORM

| FUSELAGE PAYLOAD COMPUTATIONS | | | | ITEM | WEIGHT (POUNDS) | MOMENT/100 |
|-------------------------------|--------|-----------------|------------|---|-----------------|------------|
| ITEM | ARM | WEIGHT (POUNDS) | MOMENT/100 | | | |
| | | | | 1. BASIC EMPTY WEIGHT * Airplane CG = _____ | | |
| OCCUPANTS | | | | 2. FUSELAGE PAYLOAD | | |
| SEAT 1 | 137.00 | | | 3. ZERO FUEL WEIGHT WITH ZERO WING LOCKER PAYLOAD (sub-total) (Do not exceed weight limit of 8500 pounds) | | |
| SEAT 2 | 137.00 | | | | | |
| SEAT 3 | | | | 4. WING LOCKER PAYLOAD | | |
| SEAT 4 | | | | | | |
| SEAT 5 | | | | 5. FUEL LOADING | | |
| SEAT 6 | | | | | | |
| SEAT 7 | | | | 6. RAMP WEIGHT (sub-total) (Do not exceed maximum ramp weight of 9435 pounds) | | |
| SEAT 8 | | | | | | |
| SEAT 9 | | | | 7. LESS FUEL FOR TAXIING | | |
| SEAT 10 | | | | | | |
| SEAT 11 | | | | 8. ** TAKEOFF WEIGHT (Do not exceed maximum takeoff weight of 9360 pounds) * Airplane CG = _____ *** | *** | |
| SEAT 12 | | | | | | |
| SEAT 13 | | | | | | |
| SEAT 14 | | | | | | |
| CARGO | | | | 9. LESS FUEL TO DESTINATION | | |
| AVIONICS | 32.00 | | | 10. ** LANDING WEIGHT (Do not exceed maximum landing weight of 9360 pounds) * Airplane CG = _____ *** | *** | |
| NOSE | 71.00 | | | | | |
| CARGO A | 170.00 | | | * Airplane CG = $\frac{\text{MOMENT}/100}{\text{WEIGHT}} \times 100$ | | |
| CARGO B | 197.00 | | | | | |
| CARGO C | 224.00 | | | ** Totals must be within approved weight and center-of-gravity limits. It is the responsibility of the operator to ensure that the airplane is loaded properly. The Basic Empty Weight CG is noted on the Airplane Weighing Form. If the airplane has been altered, refer to the Weight and Balance Record for information. | | |
| CARGO D | 251.00 | | | | | |
| CARGO E | 278.00 | | | | | |
| AFT CABIN FLOOR | 281.00 | | | | | |
| BAY A | 301.00 | | | *** Enter on the Center-of-Gravity Limits Envelope Graph to check if within approved limits (shaded area). | | |
| BAY B | 317.00 | | | | | |
| CABINET CONTENTS | | | | | | |
| FUSELAGE PAYLOAD | | | | | | |

1672-6



SECTION 7
DESCRIPTION OF THE AIRPLANE AND ITS SYSTEMS**TABLE OF CONTENTS**

| | Page |
|---|------|
| INTRODUCTION | 7-5 |
| AIRFRAME | 7-5 |
| FLIGHT CONTROLS | 7-5 |
| Aileron System | 7-6 |
| Aileron Trim System | 7-7 |
| Elevator System | 7-8 |
| Elevator Trim System | 7-9 |
| Rudder System | 7-10 |
| Rudder Trim System | 7-11 |
| INSTRUMENT PANEL | 7-14 |
| Overhead Console | 7-14 |
| Annunciator Panel | 7-15 |
| FLIGHT INSTRUMENTS | 7-19 |
| GROUND CONTROL | 7-20 |
| Nosewheel Steering System | 7-20 |
| Minimum Turning Distance | 7-21 |
| WING FLAPS SYSTEM | 7-21 |
| LANDING GEAR | 7-23 |
| Landing Gear Safety Switches | 7-23 |
| Landing Gear Position Lights | 7-25 |
| Landing Gear Warning Horn | 7-25 |
| Landing Gear Emergency Extension System | 7-26 |
| Landing Gear Shock Struts | 7-26 |
| BAGGAGE COMPARTMENTS | 7-28 |
| Cargo Loading | 7-29 |
| SEATS, SEAT BELTS AND SHOULDER HARNESSSES | 7-30 |
| Pilot and Copilot Provisions | 7-30 |
| Passenger Provisions | 7-30 |
| DOORS, WINDOWS AND EXITS | 7-31 |
| Cabin Door | 7-31 |
| Crew Door | 7-32 |
| Cargo Door | 7-33 |
| Windows | 7-33 |
| Emergency Exit/Ventilation Windows | 7-33 |
| CONTROL LOCK | 7-34 |

TABLE OF CONTENTS (CONTINUED)

| | Page |
|---|------|
| ENGINE | 7-34 |
| Engine Controls | 7-35 |
| Engine Instrumentation | 7-38 |
| Engine Break-In Procedure | 7-39 |
| Engine Oil System | 7-39 |
| Ignition System | 7-39 |
| Air Induction System | 7-40 |
| Inertial Separator System | 7-40 |
| Exhaust System | 7-40 |
| Cowl Flaps | 7-42 |
| Starting System | 7-42 |
| Engine Accessories | 7-42 |
| Engine Shock Mounts | 7-46 |
| Fire Detection and Extinguishing System | 7-46 |
| PROPELLER | 7-46 |
| Overspeed Governor Test Switch | 7-48 |
| FUEL SYSTEM | 7-48 |
| Fuel Tanks | 7-48 |
| Drain Valves | 7-49 |
| Fuel Indicating System | 7-49 |
| Fuel Pumps | 7-49 |
| Vent System | 7-53 |
| Crossfeed System | 7-53 |
| Firewall Shutoff Valve Switches | 7-54 |
| Fuel Flow Gages | 7-54 |
| Fuel Quantity Gage | 7-54 |
| Fuel Level Low Warning Lights | 7-54 |
| Engine Fuel System | 7-54 |
| HYDRAULIC SYSTEM | 7-55 |
| BRAKE SYSTEM | 7-57 |
| ELECTRICAL SYSTEM | 7-57 |
| Battery | 7-58 |
| Battery and Generator Switches | 7-58 |
| Generator Control Units | 7-59 |
| Voltmeter and Ammeters | 7-59 |
| Circuit Breakers, Switch Breakers and Fuses | 7-59 |
| Spare Fuses | 7-59 |
| AC Power | 7-62 |
| External Power Receptacle | 7-62 |

TABLE OF CONTENTS (CONTINUED)

| | Page |
|---|--------------------|
| LIGHTING SYSTEMS | 7-62 |
| External Lighting | 7-62 |
| Internal Lighting | 7-64 |
| BLEED AIR SYSTEM | 7-66 |
| HEATING, VENTILATING AND DEFROSTING SYSTEMS | 7-68 |
| Cabin Air System | 7-68 |
| Heating and Defrosting | 7-68 |
| Cabin Heat Controls | 7-68 |
| Cabin Air Controls | 7-69 |
| Air Duct Overheat Switch | 7-69 |
| Ventilating System | 7-69 |
| OXYGEN SYSTEM | 7-71 |
| PITOT/STATIC PRESSURE SYSTEM | 7-73 |
| Pilot's System | 7-73 |
| Copilot's System | 7-73 |
| PNEUMATIC SYSTEM | 7-73 |
| STALL WARNING SYSTEM | 7-75 |
| ICING EQUIPMENT | 7-79 |
| Propeller Deice System | 7-79 |
| AVIONICS | 7-79 |
| Avionics Interference | 7-80 |
| Avionics Master Switches | 7-80 |
| 1000 Audio Control Panel | 7-80 |
| Locator Beacon | 7-85 |
| 400 Marker Beacon | 7-85 |
| 400 Glideslope | 7-88 |
| 400 Automatic Direction Finder | 7-90 |
| 400 Nav/Com | 7-92 |
| 800 Yaw Damper | 7-98 |
| ELECTRICAL ELEVATOR TRIM | 7-99 (7-100 blank) |
| CABIN FEATURES | 7-99 (7-100 blank) |
| Cabin Fire Extinguisher | 7-99 (7-100 blank) |

LIST OF FIGURES

| Figure | Page |
|--|------|
| 7-1 Aileron System | 7-6 |
| 7-2 Aileron Trim System | 7-7 |
| 7-3 Elevator System | 7-8 |
| 7-4 Elevator Trim System | 7-9 |
| 7-5 Rudder System | 7-10 |
| 7-6 Rudder Trim System | 7-11 |
| 7-7 Instrument Panel | 7-12 |
| 7-8 Overhead Console | 7-14 |
| 7-9 Annunciator Panel and Warning Lights | 7-16 |
| 7-10 Nosewheel Steering System | 7-20 |
| 7-11 Minimum Turning Distance | 7-21 |
| 7-12 Wing Flaps System | 7-22 |
| 7-13 Landing Gear System | 7-24 |
| 7-14 Emergency Blow Down Bottle Pressure Gage | 7-27 |
| 7-15 Landing Gear Emergency Extension System | 7-27 |
| 7-16 Powerplant System | 7-36 |
| 7-17 Engine Air Flow | 7-41 |
| 7-18 Propeller Synchrophaser | 7-45 |
| 7-19 Fuel System Schematic | 7-50 |
| 7-20 Wing Fuel Hopper Tank Schematic | 7-51 |
| 7-21 Hydraulic System Schematic | 7-56 |
| 7-22 Hydraulic Reservoir Sight Gage | 7-57 |
| 7-23 Electrical System Schematic | 7-60 |
| 7-24 Left and Right Side Consoles | 7-61 |
| 7-25 Cockpit Lighting and Controls | 7-65 |
| 7-26 Cabin Lighting and Controls | 7-65 |
| 7-27 Bleed Air Shutoff Valve | 7-67 |
| 7-28 Bleed Air System Schematic | 7-67 |
| 7-29 Cabin Air System Schematic | 7-70 |
| 7-30 Cockpit Oxygen Outlets | 7-71 |
| 7-31 Oxygen Duration Chart | 7-72 |
| 7-32 Pitot/Static Pressure System | 7-74 |
| 7-33 Instrument Air System Schematic | 7-76 |
| 7-34 1000 Audio Control Panel | 7-81 |
| 7-35 Marker Facilities | 7-86 |
| 7-36 400 Marker Beacon Indicator Lights | 7-87 |
| 7-37 Glideslope Indicator | 7-89 |
| 7-38 400 ADF Controls and Indicators | 7-91 |
| 7-39 400 NAV/COM Controls Panel and Indicators | 7-94 |
| 7-40 Yaw Damper | 7-98 |

INTRODUCTION

Section 7 provides a description and operation of the airplane and its systems.

NOTE

Operational procedures for optional systems and equipment are presented in Section 9.

AIRFRAME

The Model 406 is an all-metal, low-wing airplane. The fuselage and empennage are of semimonocoque construction. The wing and horizontal and vertical tail surfaces are of conventional aluminum construction. The center wing uses 3 main spars which attach to fuselage at bulkhead locations. The outer panel wing has 2 main spars which attach to the center wing assembly spars. The retractable landing gear is a tricycle design using oil-over-air gear shock struts.

FLIGHT CONTROLS

The flight controls consist of the ailerons, elevators and rudder and their respective trim systems. All of these surfaces are constructed of aluminum and are statically mass balanced.

AILERON SYSTEM

Each aileron, refer to Figure 7-1, is attached to the rear main wing spar at two points. The aileron is actuated by a bellcrank which is attached to a wheel in the wing. The wheel is actuated by cables attached to the pilot's control wheel. An aileron-rudder interconnect spring is incorporated to improve lateral stability.

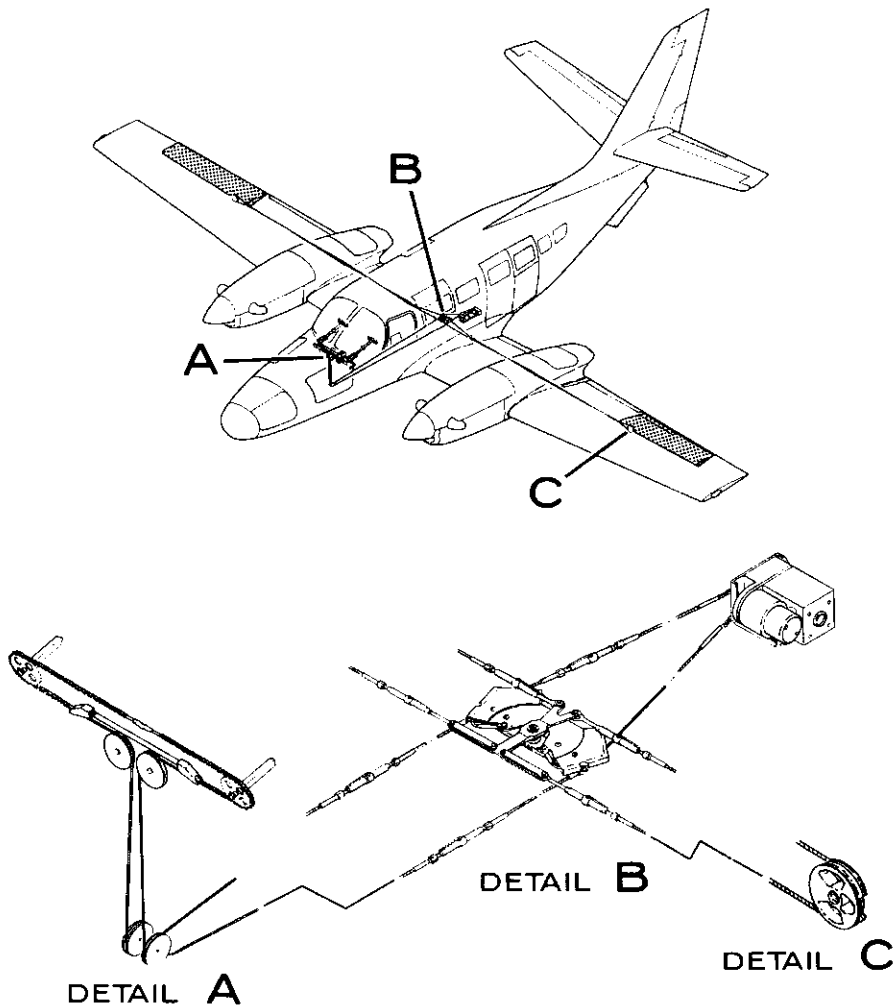
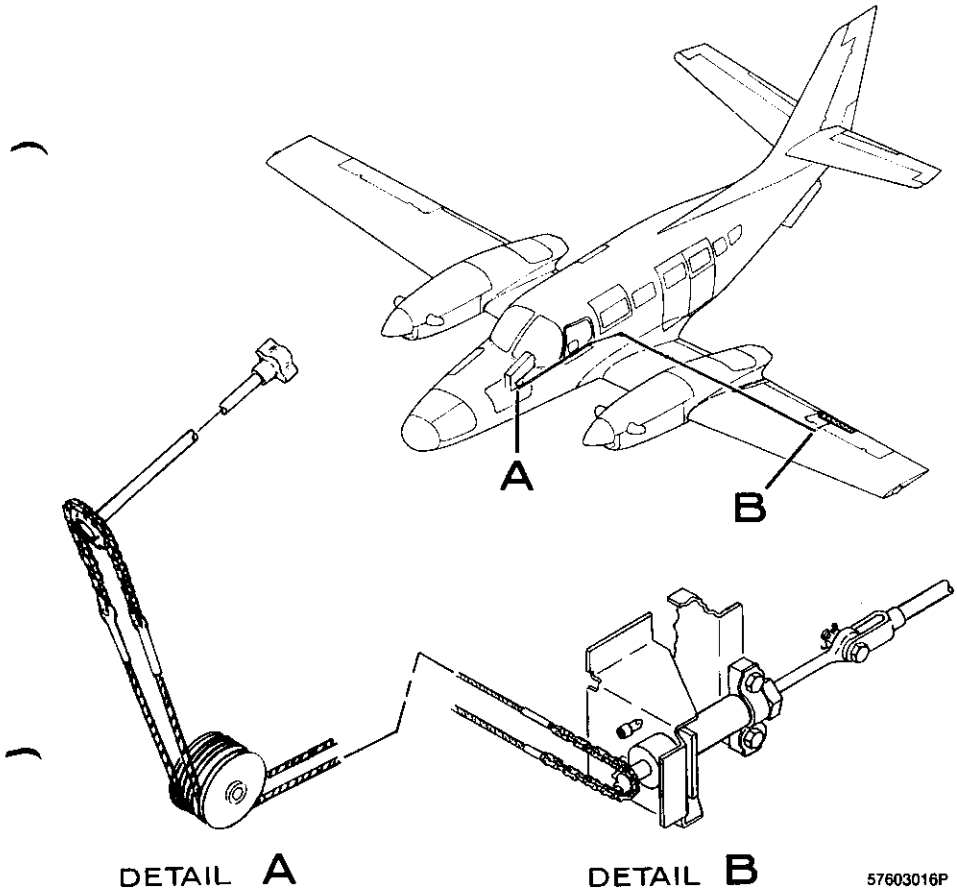


Figure 7-1
AILERON SYSTEM

57603012P
A58611022
B57611018
C51612017

AILERON TRIM SYSTEM

Aileron trim, refer to Figure 7-2, is achieved by a trim tab attached to the left aileron with a full length piano-type hinge. The trim tab is actuated by a push-pull rod which is attached to a jack screw type actuator in the wing. The actuator is driven by cables attached to the trim control knob on the cockpit control pedestal.



57603016P
A51611043
B57611019

Figure 7-2
AILERON TRIM SYSTEM

ELEVATOR SYSTEM

The two elevator control surfaces, refer to Figure 7-3, are connected by torque tubes. Each elevator assembly is attached to the rear spar of the horizontal stabilizer at three points. The elevator assembly is actuated by push-pull rods which are attached to a bellcrank in the empennage. The bellcrank is actuated by cables attached to the pilot's control wheel.

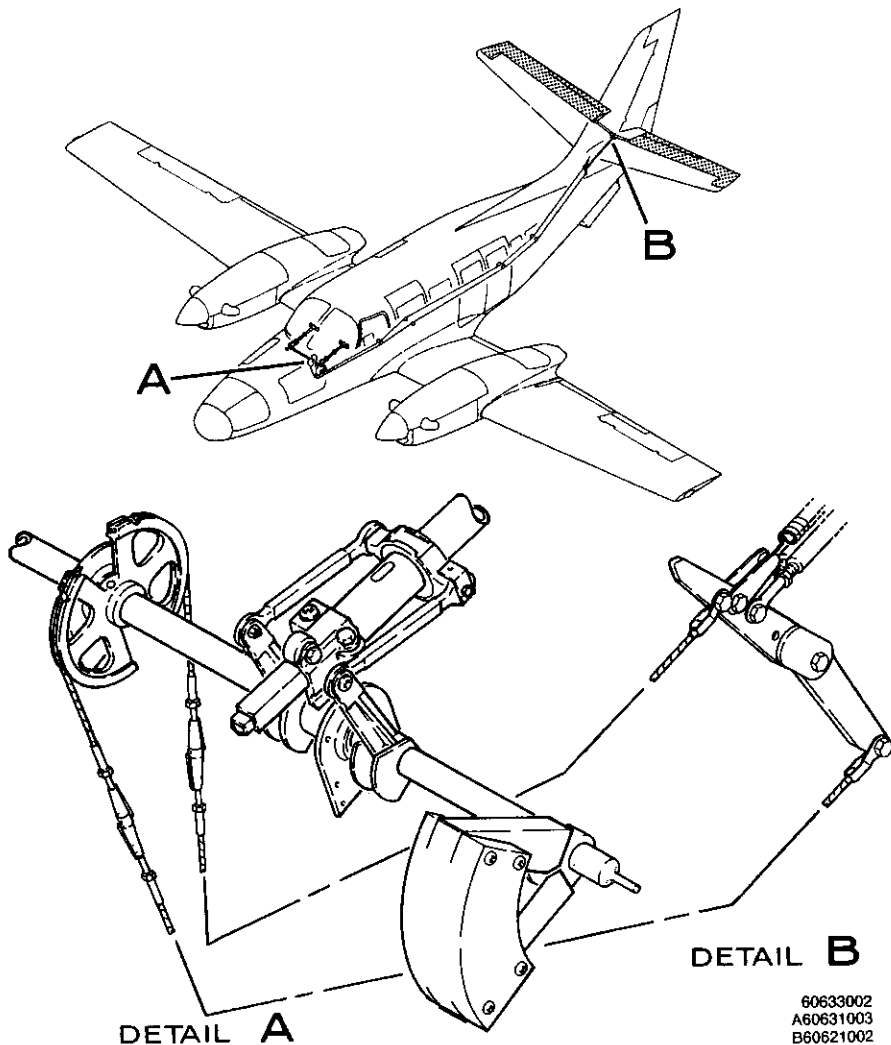


Figure 7-3
ELEVATOR SYSTEM

ELEVATOR TRIM SYSTEM

Elevator trim, refer to Figure 7-4, is achieved by elevator trim tabs attached to the right and left elevators with a full length piano-type hinge. The trim tabs are actuated by pushpull rods which are attached to dual jack screw type actuators in the horizontal stabilizer. The actuators are driven by cables attached to the trim control wheel on the cockpit control pedestal.

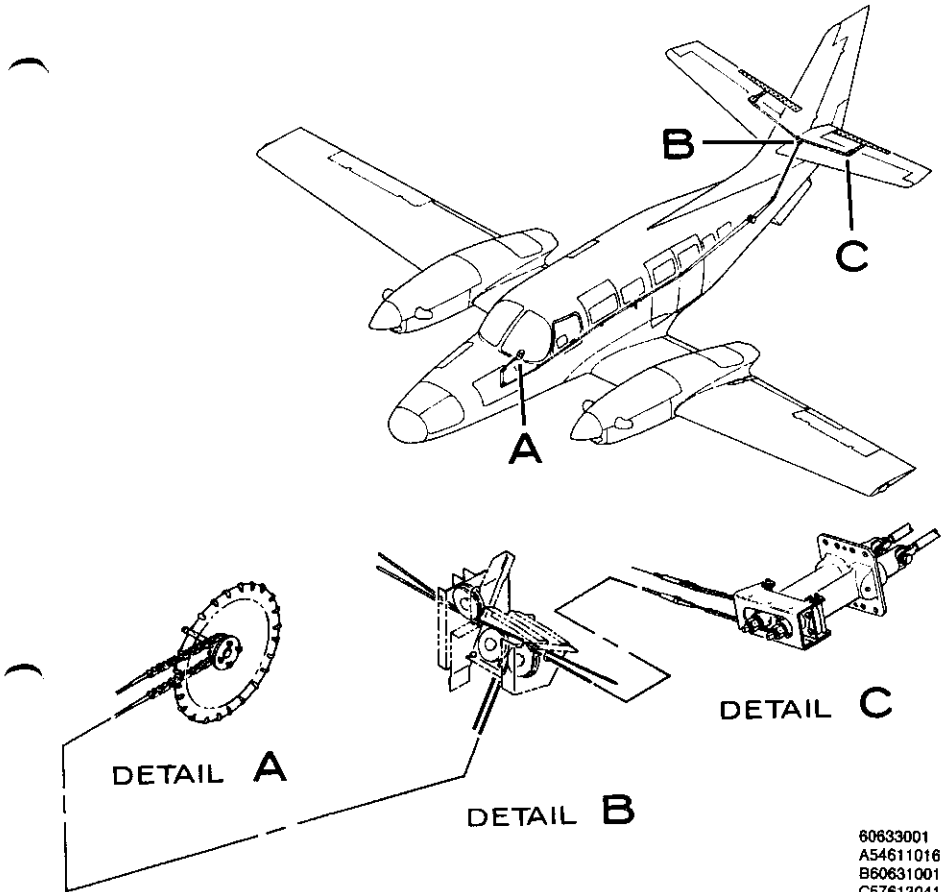


Figure 7-4
ELEVATOR TRIM SYSTEM

60633001
A54611016
B60631001
C57613041

RUDDER SYSTEM

The rudder, refer to Figure 7-5, is attached to the vertical stabilizer rear main spar at three points. The rudder is actuated by a bellcrank attached to the bottom of the rudder. The bellcrank is actuated by cables attached to the cockpit rudder pedals. A rudder-aileron interconnect spring is incorporated to improve lateral stability.

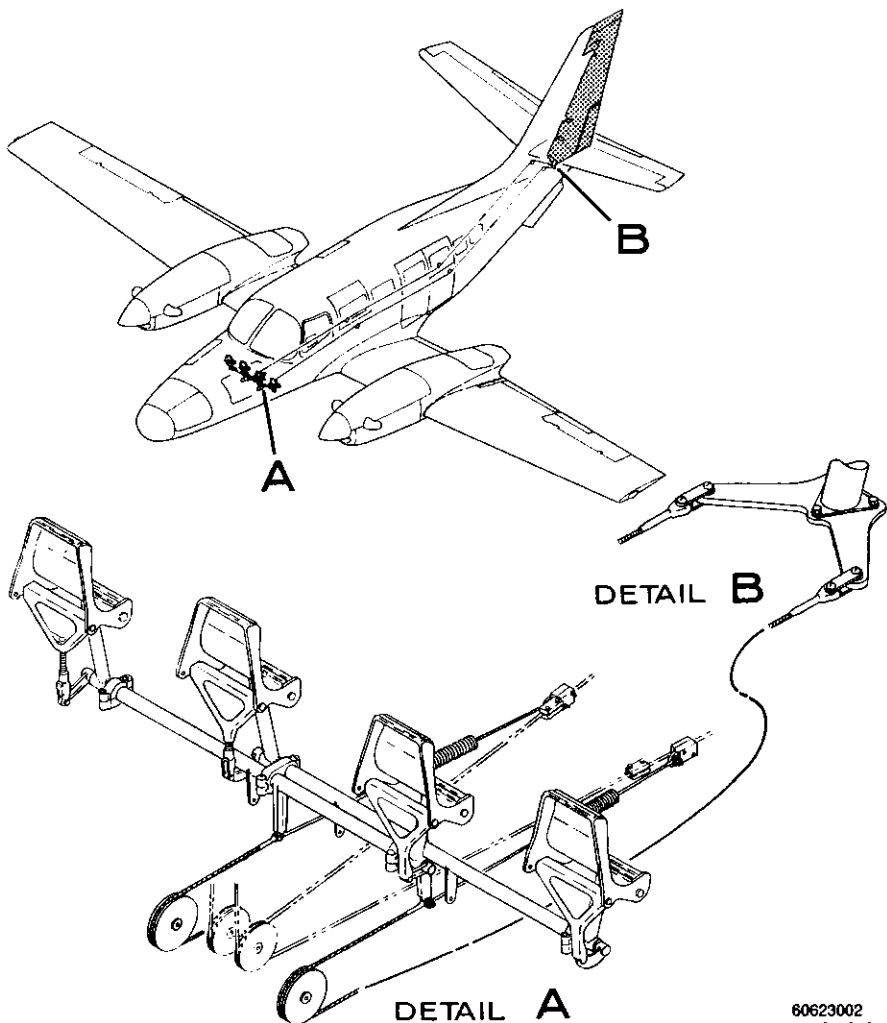


Figure 7-5
RUDDER SYSTEM

60623002
A54611010
B60621002

RUDDER TRIM SYSTEM

Rudder trim, refer to Figure 7-6, is achieved by a trim tab attached to the lower half of the rudder with a full length piano-type hinge. The trim tab is actuated by a push-pull rod which is attached to a jack screw type actuator in the vertical stabilizer. The actuator is driven by cables attached to the rudder trim wheel on the cockpit control pedestal.

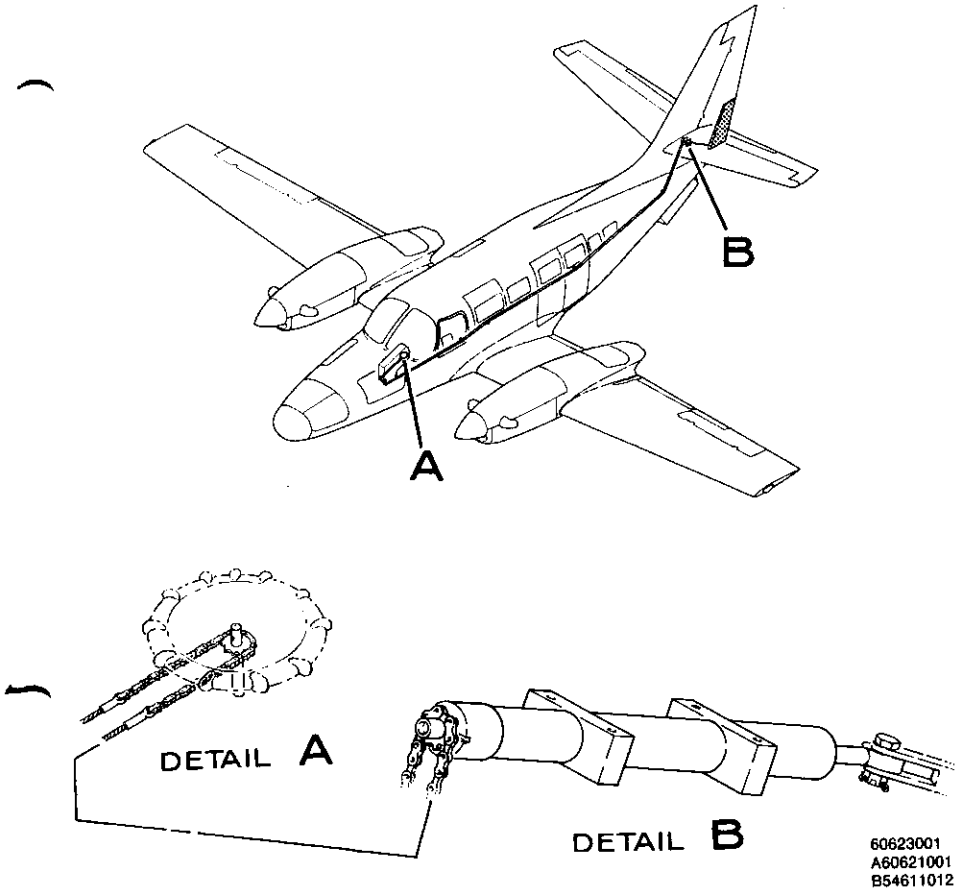
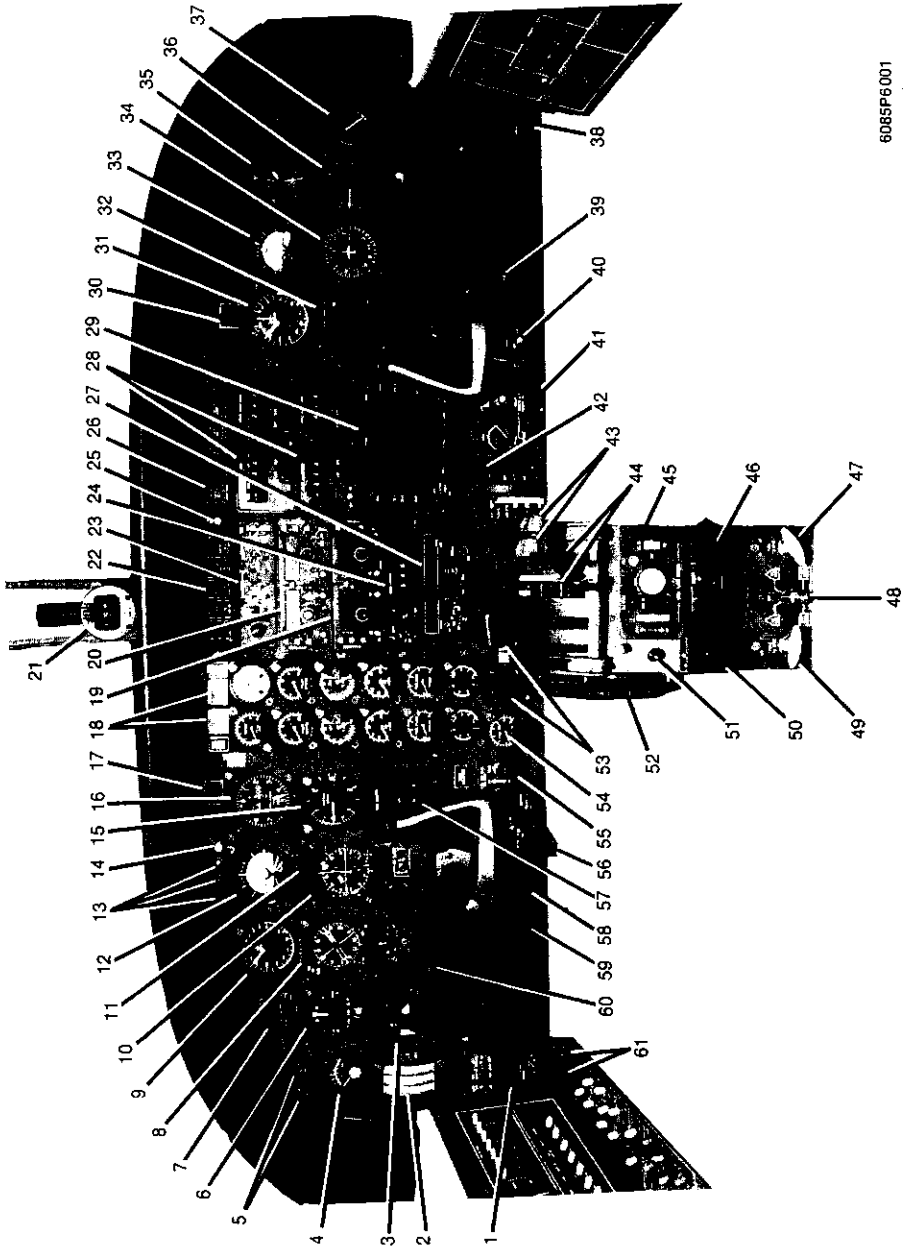


Figure 7-6
RUDDER TRIM SYSTEM



6065P6001

**Figure 7-7 (Sheet 1 of 2)
INSTRUMENT PANEL (TYPICAL)**

- | | | | |
|-----|--|-----|--|
| 1. | Instrument Air Pressure Gage | 32. | Distance Measuring Equipment (DME) |
| 2. | Voltmeters | 33. | Attitude Gyro |
| 3. | Radio Altimeter | 34. | Directional Gyro |
| 4. | Outside Air Temperature Gage | 35. | Copilot's Encoding Altimeter |
| 5. | Propeller Deice Gages | 36. | Rate-of-Climb Indicator |
| 6. | Yaw Damper and Turn and Bank Indicator | 37. | Oxygen Cylinder Pressure Gage |
| 7. | Digital Clock | 38. | Copilot's Instrument Air Pressure Gage |
| 8. | Radio Magnetic Indicator (RMI) | 39. | Air Conditioning Control Panel |
| 9. | Airspeed Indicator | 40. | Fresh Air Fan Switch |
| 10. | Horizontal Situation Indicator (HSI) | 41. | Heating Control Panel |
| 11. | Autopilot Mode Annunciator Repeater | 42. | Flap Control |
| 12. | Attitude Gyro | 43. | Fuel Control Levers |
| 13. | Marker Beacon Lights | 44. | Propeller Control Levers |
| 14. | Marker Beacon Test Switch | 45. | Autopilot Control Panel |
| 15. | Rate-of-Climb Indicator | 46. | Rudder Trim Control |
| 16. | Encoding Altimeter | 47. | Cowl Flap Control |
| 17. | Pilot's Master Warning Light | 48. | Fuel Crossfeed Selector |
| 18. | Firewall Shutoff Valves | 49. | Cowl Flap Control |
| 19. | NAV/COM Control Panel | 50. | Aileron Trim Control |
| 20. | NAV/COM Control Panel | 51. | Propeller Synchrophaser Control Panel |
| 21. | Standby Compass | 52. | Elevator Trim Control |
| 22. | Annunciator Panel | 53. | Power Levers |
| 23. | Audio Control Panel | 54. | Engine Instruments |
| 24. | Transponder Control Panel | 55. | Landing Gear Control Handle |
| 25. | Annunciator Test Switch | 56. | Emergency Landing Gear Control |
| 26. | Annunciator Panel | 57. | Autopilot Mode Selector |
| 27. | HF Control Panel | 58. | Parking Brake Control |
| 28. | ADF Control Panel | 59. | Oxygen Control |
| 29. | Weather Radar | 60. | Course Indicator |
| 30. | Copilot's Master Warning Light | 61. | Ignition Lights |
| 31. | Airspeed Indicator | | |

Figure 7-7 (Sheet 2 of 2)
INSTRUMENT PANEL (TYPICAL)

INSTRUMENT PANEL

The instrument panel, refer to Figure 7-7, contains the instruments and controls necessary for safe flight. The instrument panel presented is typical, as it contains all standard items and a good selection of popular optional equipment. The function and operation of the instrument panel features not described here have been explained in this section or Section 9 under the applicable system.

OVERHEAD CONSOLE

The overhead console, refer to Figure 7-8, includes the avionics speaker, instrument panel floodlight and map lights with dimming controls and pilot and copilot overhead directional air vents.

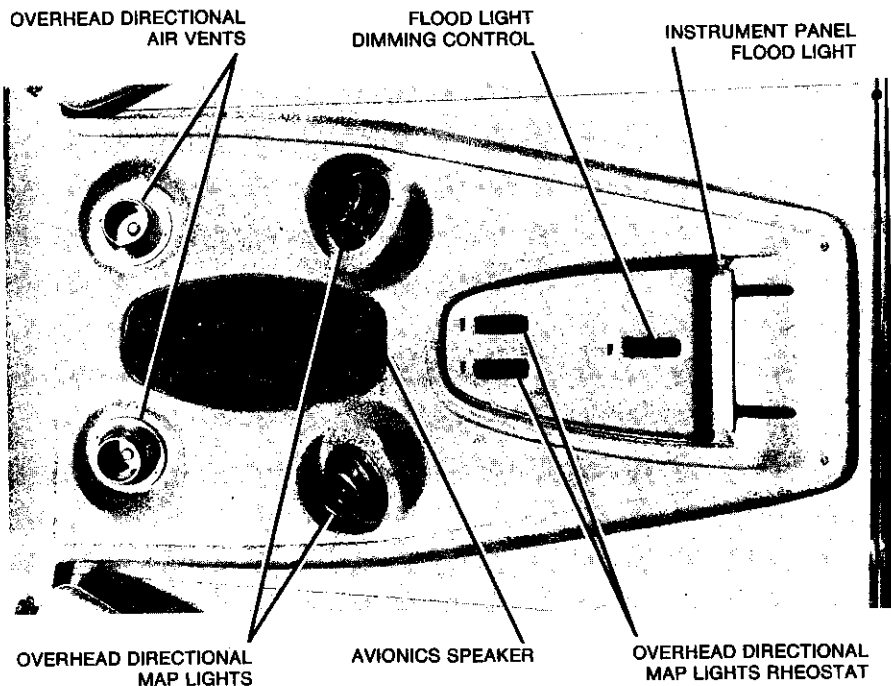


Figure 7-8
OVERHEAD CONSOLE

6085P6010

ANNUNCIATOR PANEL

The annunciator panel, refer to Figure 7-9, is located below the glare shield on the center instrument panel. The panel annunciates items of interest to the pilot in the applicable color of red, amber, green or white. Additional annunciators are provided on the airplane for specific standard or optional avionics systems; these annunciators are described with their associated systems in this section or Section 9.

When a hazardous condition exists, requiring immediate corrective action, a red warning light will illuminate. When an impending possibly dangerous condition exists, requiring attention but not necessarily immediate action, an amber light will illuminate. A green or white light will illuminate to indicate a safe or normal configuration, condition of performance, operation of essential equipment or to attract attention and impart information of routine action purposes.

A press-to-test button is provided in the center of the annunciator panel. With the battery and avionics switches ON and the press-to-test switch actuated, the stall warning horn will sound and annunciator illumination will occur on all annunciator panel lights, ignitor on lights, fire warning lights, landing gear position and unlocked lights, propeller synchophaser light, autopilot mode selector and remote mode annunciator repeater lights, marker beacon lights, BC and RNAV lights in Nav 2 Course Indicator and master warning lights. If the power levers are retarded approximately one inch forward of flight idle detent or wing flaps extended beyond the 20 degree position, the landing gear warning horn will sound if the landing gear is not down and locked. Also, lowering the wing flaps beyond the 20 degree position with the PRESS-TO-TEST button activated, will cause the landing gear warning horn to sound.

| | | | | |
|----------------------------|-------------------------------|--------------------------------|------------------------------|--------------------------------|
| L OIL PRESS ¹ | L WING O'HEAT ² | L FUEL SHUTOFF ³ | AC FAIL ⁴ | BATT O'HEAT ⁵ |
| L GEN OFF ⁶ | L FUEL PRESS LOW ⁷ | L AUX PUMP ON ⁸ | L FILTER BYPASS ⁹ | L XFER PUMP FAIL ¹⁰ |
| HYD PRESS ON ¹¹ | L HYD FLOW LOW ¹² | L FUEL LEVEL LOW ¹³ | L INERTIAL SEP ¹⁴ | L AUTO-FTHER ARM ¹⁵ |

LEFT ANNUNCIATOR

60186001

NOTE

●The numbered annunciator panel lights correspond to the following numbered descriptive text items.

●A spare white light lens is installed in each blank location of the annunciator panel when the optional system is not installed. These lenses can be replaced with the appropriate lenses when optional equipment is installed.

1. LEFT OIL PRESSURE (RED) - Indicates left engine oil pressure less than 40 PSI.
2. LEFT WING OVERHEAT (RED) - Indicates left wing leading edge temperature is above 110 degrees Celsius due to a failure of the bleed air supply line. The left engine bleed valve shutoff will automatically actuate, terminating bleed air flow.
3. LEFT FUEL SHUTOFF (AMBER) - Indicates left engine fuel flow has been terminated at the firewall.
4. ALTERNATING CURRENT FAILURE (AMBER) - Indicates loss of AC power has occurred.
5. BATTERY OVERHEAT (RED) - Light will be off when the battery temperature is less than 63 degrees Celsius. When the battery temperature is between 63 degrees Celsius and 71 degrees Celsius, the light will illuminate steadily. When the battery temperature is above 71 degrees Celsius or the PRESS TO TEST switch is actuated, the light will flash.
6. LEFT GENERATOR OFF (AMBER) - Indicates L GEN switch is off or generator malfunction exists.
7. LEFT FUEL PRESSURE LOW (AMBER) - Indicates low pressure or failure of the left fuel boost pump.
8. LEFT AUXILIARY BOOST PUMP ON (AMBER) - Indicates left fuel boost pump is in operation. Illumination is normal when the L AUX PUMP switch is positioned to ON. The amber L AUX PUMP ON light will also illuminate when the L AUX PUMP switch is in the NORMAL position and insufficient fuel pressure is sensed at the ejector pump.
9. LEFT FILTER BYPASS (AMBER) - Indicates fuel pressure drop across the fuel filter is greater than 1.60 ± 0.10 psi - additional contamination will cause the filter to be bypassed.
10. LEFT FUEL TRANSFER PUMP (AMBER) - Indicates failure of the forward and/or aft fuel transfer ejector pump in the left wing tank. Expect unusable fuel quantity to increase, particularly in uncoordinated flight and climbs or descents. The light can also be used as a low fuel warning as it will illuminate when the total fuel quantity in the left tank is less than 230 pounds with the auxiliary boost pump off or less than 35 pounds with the auxiliary boost pump ON.
11. HYDRAULIC PRESSURE ON (AMBER) - Indicates hydraulic pressure is being applied to the landing gear retraction and extension system and/or the wing flap retraction and extension system.
12. LEFT HYDRAULIC FLOW LOW (AMBER) - Indicates insufficient flow exists and the cause may be a result of pump, lines, filter or bypass valve failure.
13. LEFT FUEL LEVEL LOW (AMBER) - Indicates approximately 160 pounds of fuel remain in the left main tank.
14. LEFT INERTIAL SEPARATOR (GREEN) - Indicates bypass operation of the inertial separator system for the left engine. Verification of the light indication can be checked by observing engine torque decreases during bypass operation.
15. LEFT AUTOFEATHER ARM (GREEN) - Indicates autofeather switch is in the armed position and left engine is above 83 ± 3 percent N_g .

Figure 7-9 (Sheet 1 of 3) ANNUNCIATOR PANEL AND WARNING LIGHTS

| | | | | | | | | | | | | | |
|---------------------|----|--------------------|----|--------------------|-------------------|------------------|-------------------|----|---------------------|---------------------|----------------|-------------------|----|
| R XFER PUMP FAIL | 16 | AIR DUCT O'HEAT | 17 | DOOR NOT LOCKED | 18 | L START | R START | 19 | R WING O'HEAT | 20 | R OIL PRESS | 21 | |
| SURFACE DEICE | 22 | SEAT BELT | 23 | R FILTER BYPASS | 24 | R AUX PUMP ON | | 25 | R FUEL PRESS LOW | 26 | R GEN OFF | 27 | |
| R AUTO FTHER ARM | 28 | W/S ANTI-ICE | | 29 | R FUEL SHUTOFF | 30 | R INERTIAL SEP | | 31 | R FUEL LEVEL LOW | 32 | R HYD FLOW LOW | 33 |

60186001

RIGHT ANNUNCIATOR

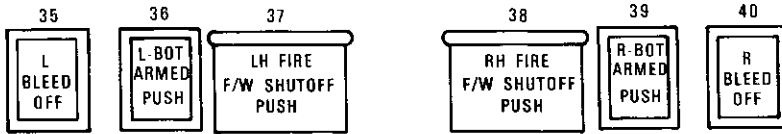
16. RIGHT FUEL TRANSFER PUMP FAIL (AMBER) - Indicates failure of the forward and/or aft fuel transfer ejector pump in the right wing tank. Expect unusable fuel quantity to increase, particularly in uncoordinated flight and climbs or descents. The light can also be used as a low fuel warning as it will illuminate when the total fuel quantity in the right tank is less than 230 pounds with the auxiliary boost pump OFF or less than 35 pounds with the auxiliary boost pump ON.
17. AIR DUCT OVERHEAT (RED) - Indicates air temperature in the cabin distribution duct is at 104 degrees Celsius (220 degrees \pm 5 degrees Fahrenheit).
18. DOOR NOT LOCKED (RED) - Indicates either one of the emergency exits (2) the forward cabin door, the aft cabin door, or the crew door is not secure for flight.
19. LEFT START AND RIGHT START (AMBER) - Indicates engine starter contactor is engaged. Lights illuminate independently.
20. RIGHT WING OVERHEAT (RED) - Indicates right wing leading edge temperature is above 110 degrees Celsius due to a failure of the bleed air supply line. The right engine bleed valve shutoff will automatically actuate terminating bleed air flow.
21. RIGHT OIL PRESSURE (RED) - Indicates right engine oil pressure less than 40 PSI.
22. SURFACE DEICE (GREEN) - Indicates deice boots have achieved proper operating pressure. The light will illuminate during the boot cycle.
23. SEAT BELT AND OXYGEN (WHITE) - Indicates individually when the respective seat belt or oxygen/no smoking signs are on.
24. RIGHT FILTER BYPASS (AMBER) - Indicates fuel pressure drop across the fuel filter is greater than 1.60 \pm 0.10 psi - additional contamination will cause the filter to be bypassed.
25. RIGHT AUXILIARY BOOST PUMP ON (AMBER) - Indicates right fuel boost pump is in operation. Illumination is normal when the R AUX PUMP switch is positioned to ON. The amber R AUX PUMP ON light will also illuminate when the R AUX PUMP switch is in the NORMAL position and insufficient fuel pressure is sensed at the ejector pump.
26. RIGHT FUEL PRESSURE LOW (AMBER) - Indicates low pressure or failure of the right fuel boost pump.
27. RIGHT GENERATOR OFF (AMBER) - Indicates R GEN switch is off or a generator malfunction exists.
28. RIGHT AUTOFEATHER ARM (GREEN) - Indicates autofeather switch is in the armed position and right engine is above 83 \pm 3 percent N_g.
29. ELECTRIC WINDSHIELD HEATER (GREEN) - Indicates heating elements in the electric windshield are operating.
30. RIGHT FUEL SHUTOFF (AMBER) - Indicates right engine fuel flow has been terminated at the firewall.
31. RIGHT INERTIAL SEPARATOR (GREEN) - Indicates bypass operation of the inertial separator system for the right engine. Verification of the light indication can be checked by observing engine torque decreases during bypass operation.
32. RIGHT FUEL LEVEL LOW (AMBER) - Indicates approximately 160 pounds of fuel remain in the main tank.
33. RIGHT HYDRAULIC FLOW LOW (AMBER) - Indicates insufficient flow exists and the cause may be a result of pump, lines, filter or bypass valve failure.

**Figure 7-9 (Sheet 2 of 3)
ANNUNCIATOR PANEL AND WARNING LIGHTS**

34



34. PILOT'S MASTER WARNING (RED) (SHOWN) and COPILOT'S MASTER WARNING (RED) (NOT SHOWN) - FLASH when initiated by the presence of any hazardous condition identified on the annunciator panel by illumination of a red warning light. The master warning lights also illuminate whenever both left and right generator off lights illuminate. The master warning lights may be pressed to cancel the master warning and reset the master warning circuit.



35. LEFT BLEED OFF (STANDARD) (YELLOW) - Indicates bleed air firewall valve is closed when left engine fire warning light was pushed. Not installed when optional fire extinguisher is installed.
36. LEFT FIRE BOTTLE ARM (OPTIONAL) (WHITE) - Indicates left engine fire extinguisher is armed and electrically capable of being fired. Pressing the bottle armed light will discharge the fire extinguisher.
37. LEFT ENGINE FIRE WARNING (RED) - Indicates engine compartment temperature has exceeded normal operating temperatures. Lifting the clear plastic cover and pressing the left engine fire warning light will arm the optional fire extinguisher, disable the generator (illuminating the respective GEN OFF annunciator light) and will close the bleed air firewall and fuel shutoff valves. The light will go out after the engine compartment has cooled to a normal temperature. Pressing the fire warning light a second time will disarm the optional fire extinguisher, reconnect the generator and open the bleed air firewall and fuel shutoff valves.
38. RIGHT ENGINE FIRE WARNING (RED) - Indicates engine compartment temperature has exceeded normal operating temperatures. Lifting the clear plastic cover and pressing the right engine fire warning light will arm the optional fire extinguisher, disable the generator (illuminating the respective GEN OFF annunciator light) and will close the bleed air firewall and fuel shutoff valves. The light will go out after the engine compartment has cooled to a normal temperature. Pressing the fire warning light a second time will disarm the optional fire extinguisher, reconnect the generator and open the bleed air firewall and fuel shutoff valves.
39. RIGHT FIRE BOTTLE ARM (OPTIONAL) (WHITE) - Indicates right engine fire extinguisher is armed and electrically capable of being fired. Pressing the bottle armed light will discharge the fire extinguisher.
40. RIGHT BLEED OFF (STANDARD) (YELLOW) - Indicates bleed air firewall valve is closed when right engine fire warning light was pushed. Not installed when optional fire extinguisher is installed.

Figure 7-9 (Sheet 3 of 3)
ANNUNCIATOR PANEL AND WARNING LIGHTS

FLIGHT INSTRUMENTS

The basic flight instruments, refer to Figure 7-7, consist of airspeed, altimeter and rate-of-climb indicators, electric turn-and-bank and pressure driven horizon and directional gyros.

Operation of the airspeed, altimeter and rate-of-climb indicators can be determined by cross-checking the copilot's instruments. Also, when a climb or descent is initiated, these instruments should indicate the appropriate change. If no change is indicated, it is reasonable to assume static source blockage has occurred. If the possibility of static source icing is present, actuation of the L or R PITOT/STATIC switch should deice the static sources. If only the airspeed indicator appears to be affected when the climb or descent is initiated, it is reasonable to assume a pitot system blockage has occurred. If the possibility of pitot source icing is present, actuation of the L or R PITOT/STATIC switch will clear the ice blockage. Reference the copilot's instruments and optional angle-of-attack indicator for airspeed information until a reliable airspeed indication can be obtained. If neither copilot's instruments or the optional angle-of-attack system is operational, fly attitude and power references.

Operation of the turn-and-bank needle can be checked by initiating a standard rate turn and cross-checking the turn rate with the directional gyro. An indicated standard rate turn should show a turning rate of 3 degrees per second on the directional gyro. After shutdown of the airplane on the ground, abnormal noise coming from the turn-and-bank can indicate a near failure condition. Inaccuracy will result if the indicator is not level in the instrument panel. With the airplane on level ground, the ball should be centered in the race.

Operation of the directional and horizon gyros can be checked during taxiing by watching for an abnormally slow erection rate and erratic operation. After shutdown of the airplane on the ground, abnormal noise coming from either gyro can indicate a near failure condition. Checking the instrument air gage for proper pressure and no failure buttons exposed will assure proper gyro pressure is available. Low copilot gyro pressure accompanied by no failure buttons exposed may indicate an overpressure condition in the bleed air system. Such an overpressure condition is further verified if the copilot gyro pressure returns to normal with the engine(s) at flight idle.

In flight, the directional gyro can be checked by flying a standard rate turn and observing the directional gyro for a turning rate of 3 degrees per second. Also the precession rate in straight and level flight should not exceed 5 degrees in 10 minutes. The horizon gyro operation can be checked by establishing a level flight attitude; the gyro should indicate wings level within 1 degree. Initiate a 20 degree bank for a 180 degree turn, then smoothly return to level flight; gyro should indicate wings level within 3 degrees. Establish level flight at 150 KIAS; gyro should

indicate level airplane within 1 degree. Smoothly pitch airplane nose down 10 degrees, then return to level flight; gyro should indicate level flight within 1 degree.

GROUND CONTROL

NOSEWHEEL STEERING SYSTEM

The nosewheel steering system, refer to Figure 7-10, consists of the rudder pedals, nose gear, bungee spring assembly and cables. During ground operation, the nose gear steering system is actuated by the rudder pedals, allowing normal directional control.

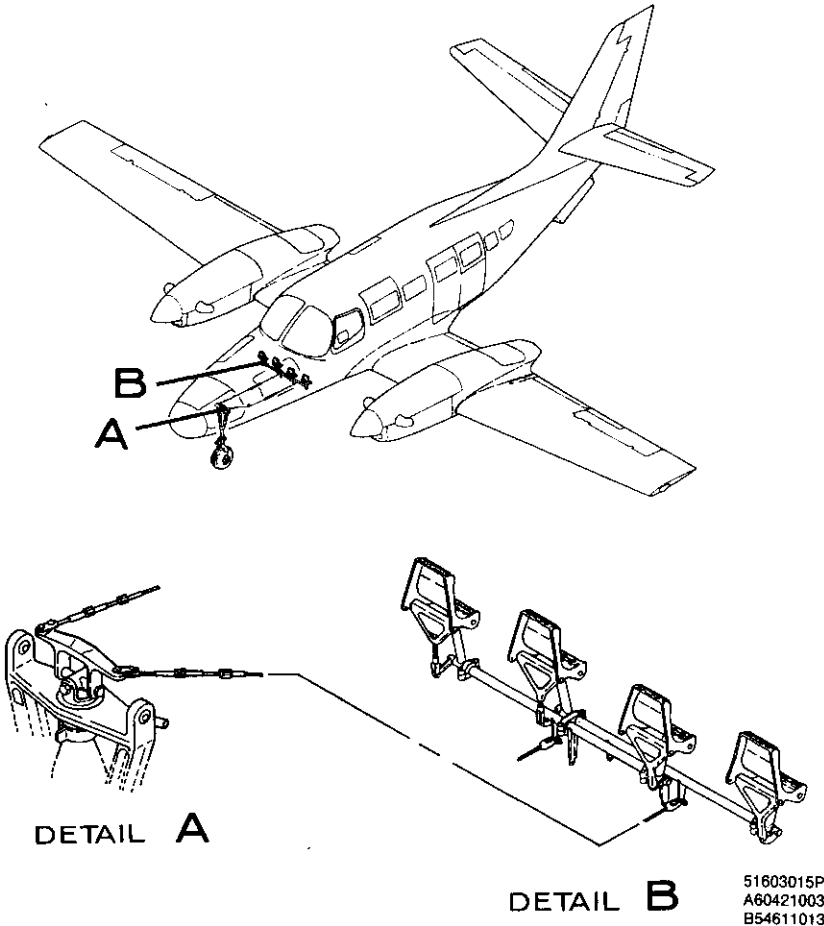


Figure 7-10
NOSEWHEEL STEERING SYSTEM

MINIMUM TURNING DISTANCE

The minimum turning distance is presented in Figure 7-11. Always use as large a radius of turn as is practical. Turning tighter than necessary requires excessive braking on the inboard wheel which decreases the tire life.

NOTE

Minimum turning distance is effected with in-board wheel brake locked, full rudder and differential power.

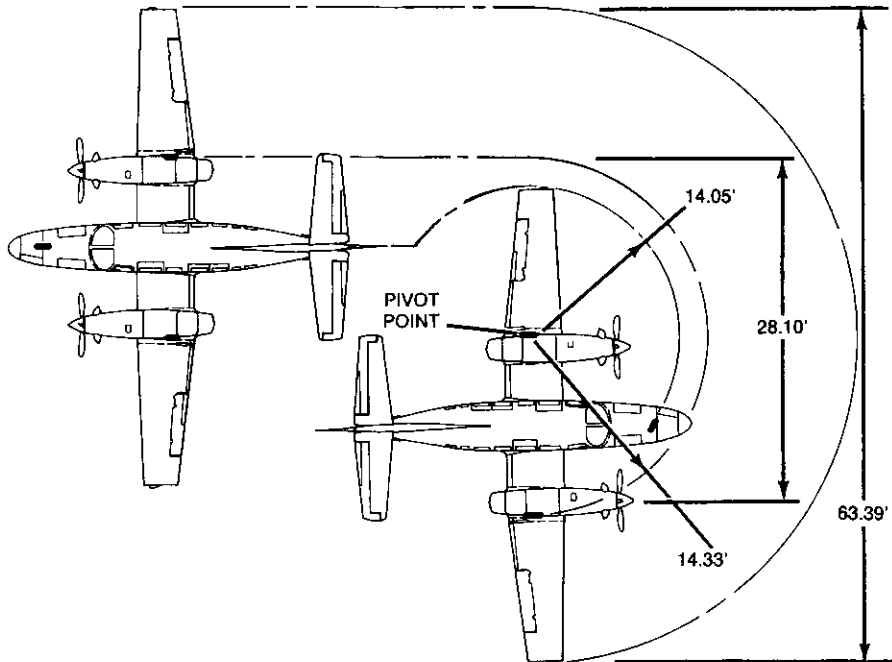


Figure 7-11
MINIMUM TURNING DISTANCE

60856003

WING FLAPS SYSTEM

The wing flaps, refer to Figure 7-12, are the extensible Fowler type. Each wing flap (two per side) is mounted on tracks which are attached to the wing rear spar. The wing flap sections are actuated by push-pull rods attached to bellcranks in the wing. The bellcranks in each wing are interconnected with push-pull rods. Each inboard push-pull rod is attached to the center bellcrank which is actuated by a hydraulic flap actuator.

The hydraulically operated flap actuator is controlled by the wing flap position switch, refer to Figure 7-7. This switch incorporates a preselect feature which allows the pilot to select the amount of flap extension desired. With the wing flaps set at the UP, T.O., APPR or LAND positions, the corresponding inboard wing flap extensions are 0, 10, 20 and 30 degrees. The outboard wing flaps are mechanically linked to the inboard sections, extending at a slower rate. When the inboard wing flaps are fully extended (30 degree), the outboard wing flaps are extended 20 degree.

Selecting the UP, T.O., APPR or LAND position on the wing flap selector switch causes the hydraulically operated flap actuator to drive the flaps toward the selected position. When the actual flap position equals the selected position, limit switches will electrically actuate the flap control valve which stops the flow of hydraulic fluid to the hydraulic flap actuator. The wing flaps will complete the extension cycle in approximately 15 seconds with both engines operating.

Hydraulic pressure to actuate the wing flaps is supplied by the hydraulic pump, refer to 7-21, which is mounted on each engine.

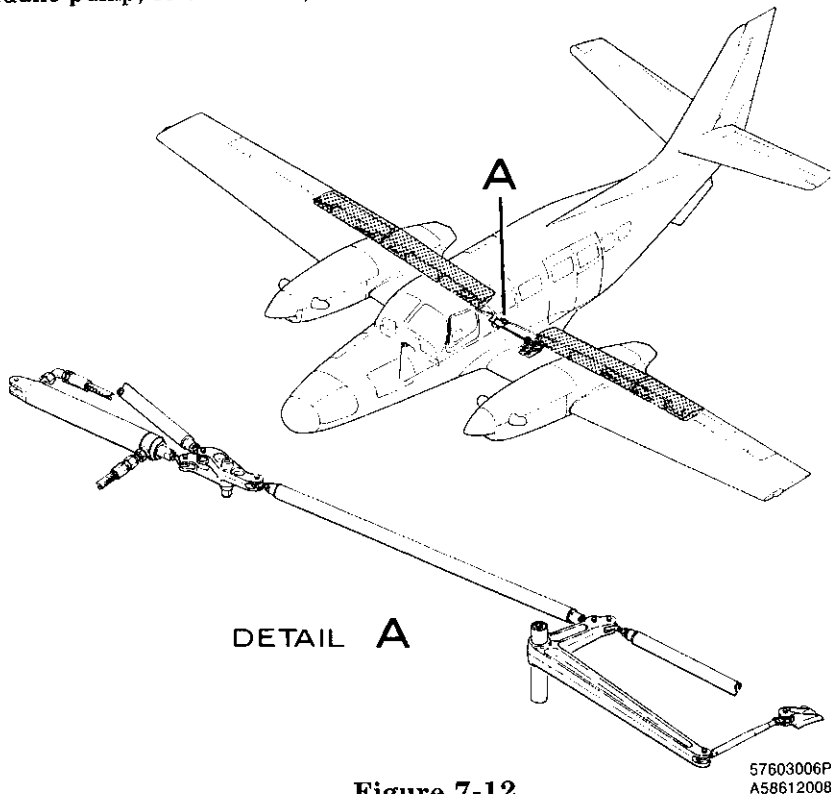


Figure 7-12
WING FLAPS SYSTEM

LANDING GEAR

The retractable tricycle landing gear, refer to Figure 7-13, is electrically controlled and hydraulically actuated. The individual landing gear actuators incorporate an internal lock to hold the landing gear in the extended position. The landing gear is held in the retracted position by mechanical uplocks that are released hydraulically during gear extension. The landing gear completes the retraction cycle in approximately 5 seconds with both engines at maximum engine RPM. The actuation cycle time increases as engine RPM decreases or with the loss of an engine-driven hydraulic pump.

Hydraulic pressure is supplied by the hydraulic pump, refer to Figure 7-21, which is mounted on each engine. An electrically actuated gear control valve controls the flow of hydraulic fluid to the individual gear cylinders. The gear control valve receives power through the landing gear position switch. During ground operation, accidental gear retraction, regardless of gear switch position, is prevented by a safety switch located on the left landing gear shock strut. The weight of the airplane compresses the shock strut, causing the safety switch to open, thus preventing electrical power from reaching the gear control valve.

The landing gear doors are mechanically linked to their respective landing gear, retracting and extending with each landing gear. The landing gear is operated by a switch, refer to Figure 7-16, which is identified by a wheel-shaped knob. The switch positions are UP and DOWN. To operate the gear, pull out the landing gear switch and move it to the desired position. This allows electrical power to energize the gear control valve and the hydraulic pressure to drive the landing gear to the selected position. The hydraulic pressure light, located on the annunciator panel, refer to Figure 7-9, will remain on until the landing gear is locked into position.

LANDING GEAR SAFETY SWITCHES

A landing gear safety switch (squat switch) is located on each main landing gear strut to control ground and airborne operation of certain equipment.

The left landing gear safety switch prevents landing gear retraction, reduces stall vane deice heat while the airplane is on the ground.

The right landing gear safety switch allows the landing gear warning horn to sound if the landing gear selector switch is moved to the retracted position while the airplane is on the ground. On the ground it also disables flight-hour recorder and Davtron Digital Clock flight time operation. Airborne, the right switch allows the flight-hour recorder and Davtron clock flight time readout to function.

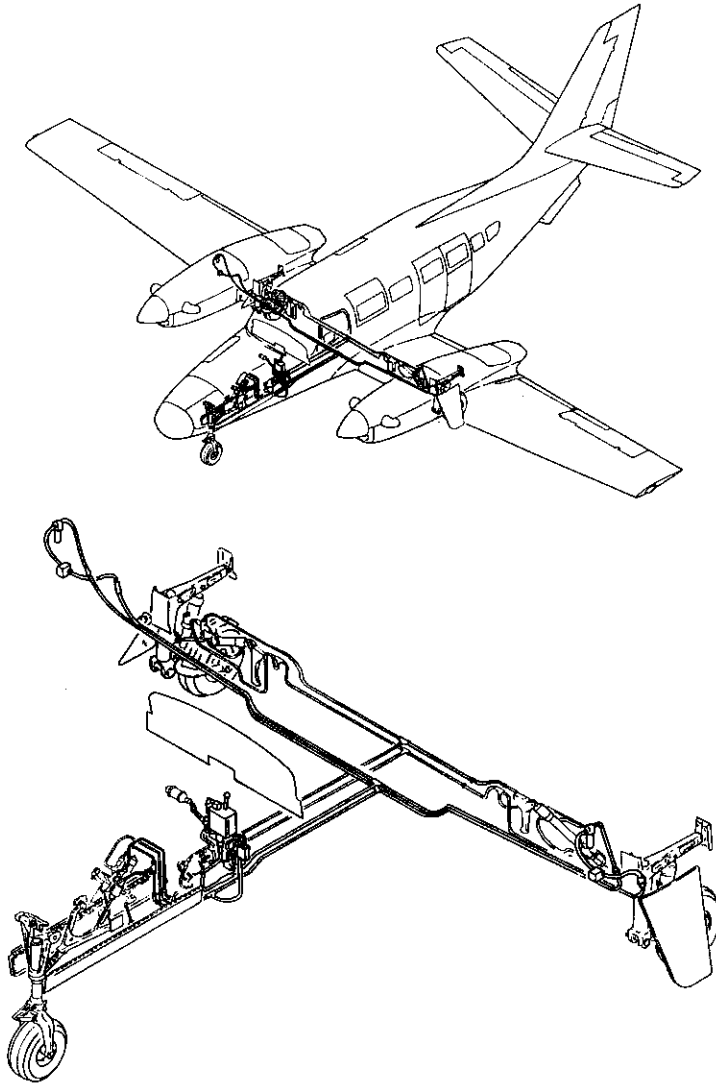


Figure 7-13
LANDING GEAR SYSTEM

60473003P
A60473003

LANDING GEAR POSITION LIGHTS

Four landing gear position indicator lights, refer to Figure 7-14, are contained in two modules located beneath the engine instruments just left of the center of the instrument panel. One module contains three of these lights (one for each gear) which are green and will illuminate when each landing gear is fully extended and locked. The other light module is red and will illuminate when any or all the gears are unlocked (intermediate position). When the gear unlocked light and gear down lights are not illuminated, the landing gear is in the UP and LOCKED position.

LANDING GEAR WARNING HORN

The landing gear warning horn is controlled by the power levers and/or the wing flap position. The warning horn will sound intermittently if either or both power levers are retarded below approximately one inch forward of the flight idle detent with the landing gear retracted or if the wing flaps are lowered beyond the 20 degree position with the landing gear in any position except extended and locked. The warning horn is also connected to the UP position of the landing gear position switch and will sound if the switch is placed in the UP position while the airplane is on the ground. The system can be checked by activating the PRESS-TO-TEST button, refer to Figure 7-9, located on the annunciator panel while retarding one power lever at a time. Also, lowering the wing flaps beyond the 20 degree position with the PRESS-TO-TEST button activated will cause the landing gear warning horn to sound.

A warning horn disable switch is provided adjacent to the landing gear switch. During rapid descents with the power levers in flight idle, the horn disable switch can be used to silence the landing gear warning horn. Once the power levers are advanced, the horn will be reset. When the wing flaps are extended beyond the 20 degree position and the landing gear is not down and locked, the horn cannot be silenced by the horn disable switch.

LANDING GEAR EMERGENCY EXTENSION SYSTEM

The landing gear emergency extension system, refer to Figure 7-15, consists of a red emergency gear extension T-handle, (located on instrument panel) a blowdown bottle, refer to Figure 7-14, located in the nose baggage compartment) and associated plumbing. The procedure for emergency gear extension is given in Section 3. Pulling the emergency control releases dry nitrogen under pressure into the shuttle valve, causing the shuttle valve to move from the hydraulic to pneumatic position. The nitrogen then flows into the uplocks which releases the gear to the freefall position, and then into the landing gear actuators, which drives the landing gear into the down and locked position.

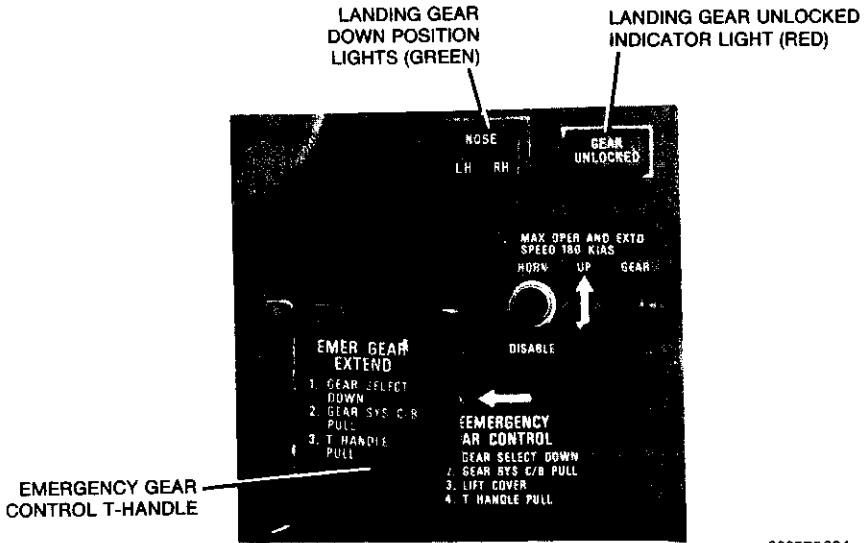
NOTE

The landing gear cannot be retracted after emergency gear extension until the system has been ground serviced.

LANDING GEAR SHOCK STRUTS

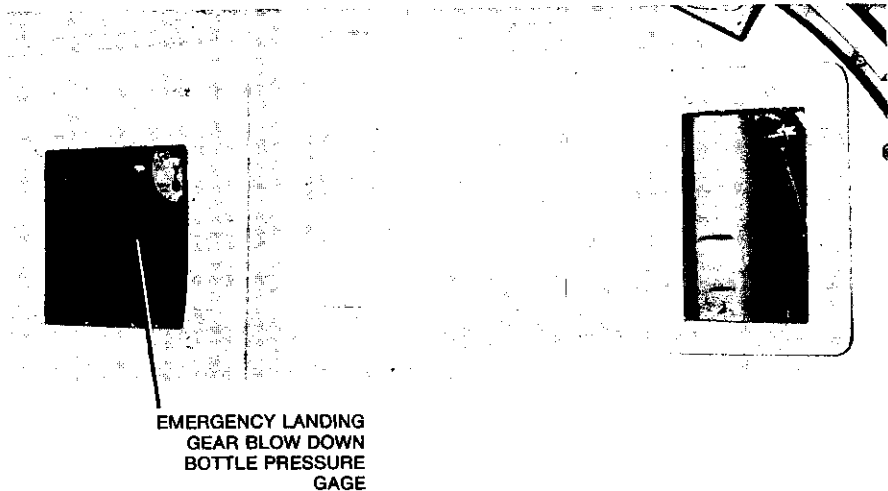
Shock absorption is provided on the landing gear by an oil-over-air shock strut. This strut is composed of an upper barrel assembly and a lower piston assembly and consists of orifice, tapered metering pin and piston and fork assembly. The metering pin increases or decreases the flow of hydraulic fluid through the orifice according to the severity of shock.

Landing gear shock struts should be checked before each flight to ensure they are not collapsed. This can readily be determined by a visual inspection of the shock strut lower piston assembly. If the unpainted surface of the lower piston assembly is not visible, the shock strut is fully collapsed and must be serviced before the airplane is flown.



6085P6004

Figure 7-14
EMERGENCY BLOW DOWN BOTTLE PRESSURE GAGE



VIEW LOOKING AFT THROUGH LEFT NOSE BAGGAGE DOOR

6085P6015

Figure 7-15
LANDING GEAR EMERGENCY EXTENSION SYSTEM

BAGGAGE COMPARTMENTS

Six baggage locations, refer to Figure 1-2, are available: two in the fuselage nose section, two in the aft cabin area and one located in the aft portion of each engine nacelle.

These baggage areas are intended primarily for low-density items such as luggage and briefcases. The floors of the wing locker baggage areas are primary structure. Therefore, care should be exercised during loading and unloading to prevent damage. When loading high-density objects, ensure that adequate protection is available to prevent damage to any of the airplane's primary structure. Without optional equipment installed, 200 pounds can be carried in each wing locker, 250 pounds in the avionics bay, 350 pounds in the nose baggage compartment, 400 pounds in the aft cabin Bay A and 100 pounds in the aft cabin Bay B. With optional equipment installed, refer to Section 2 or the loading placards in your airplane's baggage compartments.

WARNING

●THE TRANSPORTATION OF HAZARDOUS MATERIALS IS DISCOURAGED. HOWEVER, IF TRANSPORT OF THIS MATERIAL IS NECESSARY, IT SHALL BE DONE IN COMPLIANCE UNDER THE HAZARDOUS MATERIALS TRANSPORTATION ACT AND ANY OTHER APPLICABLE REGULATIONS.

●UNDER NO CIRCUMSTANCES, ALLOW THE LOADING OF PEOPLE OR ANIMALS IN THE NOSE BAGGAGE AREA. THIS AREA DOES NOT QUALIFY FOR CARRIAGE OF ANIMATE OBJECTS.

CARGO LOADING

Care should be exercised during loading and unloading to prevent damage. When loading bulky items with a fork lift truck, greater accessibility to the cargo doors can be gained by retracting the wing flaps and removing nacelle aft of baggage door. When loading high-density objects, ensure that adequate protection is available to prevent damage to any of the airplane's primary structure. Exercise caution while loading or unloading heavy cargo to prevent an out-of-balance aft center-of-gravity limit condition. Without optional equipment installed, 600 pounds of cargo can be carried in each cargo bay (A, B, C, D and E), 400 pounds on the lower aft cabin shelf (Bay A) and 100 pounds on the upper aft

cabin shelf (Bay B). Additional loading instructions in the form of limitations are presented in Section 2.

- a. Tie-downs shall be provided in such a manner that at least one forward and one aft tie-down will be available for each 150 pounds of cargo when tie-down rings are used. A minimum of four tie-down rings are required for any one piece of cargo. Tie-downs are to be located at seat stop hole locations only. In the aft cabin (Bay A), use only tie-down fittings; do not use the seat tracks.
- b. A system of retention, suitable to the cargo being loaded and having strength compatible to the seat rail tie-downs, must be used.
- c. The total airplane loading must be consistent with the weight and balance limitations of the passenger configuration airplane.
- d. (Cargo Bays A,B,C,D and E) If the cargo has a smooth, reasonable flat lower surface, load densities of up to 200 pounds per square foot may be loaded on the floorboards. If the cargo has rough or sharp edges, plywood or similar panels should be used to reduce the loading to 200 pounds per square foot. A single cargo bay may be loaded to 600 pounds at the rate of 200 pounds per square foot. Use pallets or beams to distribute the loads over all seat rails if adjacent cargo bays are loaded at a rate of over 75 pounds per square foot.
- e. (Lower aft cabin baggage shelf Bay A) If the cargo has a smooth reasonably flat lower surface, load densities of up to 75 pounds per square foot may be loaded with maximum of 200 pounds per side.
- f. (Upper aft cabin baggage shelf Bay B) If the cargo has a smooth reasonably flat lower surface, load densities of up to 75 pounds per square foot may be loaded with maximum of 50 pounds per side.
- g. (Cargo interior) The cargo barrier net may be installed at fuselage stations 161, 190, 221, 273 and 290. When installing the barrier net, attach all eight tie-down fittings then adjust net to fit the fuselage station. Four of the tie-down fittings attach to the floor on the seat rails, two of the fittings attach to overhead structure (10 inches apart, located symmetrically about the fuselage centerline), while the remaining two fittings (one on each side) attach to fuselage structure above the cabin side windows.
- h. The bulk and position of the loaded cargo should be such as to permit entrance and emergency exit of the pilot and passengers.

WARNING

●THE TRANSPORTATION OF HAZARDOUS MATERIALS IS DISCOURAGED. HOWEVER, IF TRANSPORT OF THIS MATERIAL IS NECESSARY, IT SHALL BE DONE IN COMPLIANCE UNDER THE HAZARDOUS MATERIALS TRANSPORTATION ACT AND ANY OTHER APPLICABLE REGULATIONS.

●UNDER NO CIRCUMSTANCES, ALLOW THE LOADING OF PEOPLE OR ANIMALS IN THE AVIONICS BAY, NOSE BAGGAGE AREA OR WING LOCKERS. THESE AREAS DO NOT QUALIFY FOR CARRIAGE OF ANIMATE OBJECTS.

SEATS, SEAT BELTS AND SHOULDER HARNESSSES

PILOT AND COPILOT PROVISIONS

The pilot and copilot seats are attached to seat rails located on each side of the cockpit area. The seats are adjustable fore and aft on seat rails by lifting the handle located on the forward face of the seat.

The pilot's and copilot's seats contain a five-point restraint system. The shoulder harness consists of an inertia reel secured to the seat back and two harness straps. The seat (lap) belt has a left half and right half which are secured at one end to the seat frame. One belt half is affixed to the rotary buckle and does not release. The shoulder harnesses and seat (lap) belts are mated together by the rotary buckle. The left and right (lap) belt-halves have an adjuster to permit belt adjustment and for centering the buckle. The inertia reels allow normal fore and aft movement of the occupants until a violent movement occurs, at which time the reel will lock, restricting forward movement of the seat occupant.

PASSENGER PROVISIONS (OPTIONAL INTERIOR)

The individual passenger seats are attached to continuous seat rails located on each side of the cabin area. The seats are adjustable fore and aft, within the limits of the seat stops, by raising the handle located on the front of the seat. Seat back recline angle can be adjusted by a button on the side of each seat arm rest. Seat armrests can be raised or lowered by a lever in the forward edge of the armrest. Ensure the seat stop pins

are engaged with the holes in the seat rails before takeoff and landing. Each seat is equipped with a seat belt which is attached to the seat structure, and a shoulder harness with inertial reel.

PASSENGER PROVISIONS (STANDARD INTERIOR)

The individual passenger seats are attached to continuous seat rails located on each side of the cabin area. Ensure that the seat guides are engaged and front guide tabs are down and locked in the seat rails before takeoff. The seats are considered as nonadjustable and are not to be adjusted by the passengers. Each seat is equipped with a seat belt which is attached to the seat structure. The seats do not have reclining backs. On airplanes -0011 and On, a single diagonal upper sidewall mounted shoulder harness with inertia reel is provided for each seat.

DOORS, WINDOWS AND EXITS

CABIN DOOR

The main cabin door is a two-section, outward opening, airstair door. The lower section folds down to provide two steps for ease in boarding and deplaning passengers, while the top portion folds up. The (lower) door handle is located such that the upper door must be open to gain access to it.

| |
|----------------|
| WARNING |
|----------------|

●FAILURE TO PROPERLY LATCH THE CABIN DOOR CAN ALLOW IT TO OPEN IN FLIGHT.

●REFER TO SECTION 3, EMERGENCY PROCEDURES, FOR PROPER OPERATIONAL PROCEDURES TO BE FOLLOWED IF THE ENTRY DOOR SHOULD INADVERTENTLY OPEN IN FLIGHT.

To enter the airplane, pull out on the recessed handle on the upper door section, rotate handle down and raise the door section to overcenter position. Following this action, the gas spring telescoping door lift automatically raises the door to the full up position. Once the upper section is open, release the lower section by pulling up on the inside door handle located on the lower door edge. Lower the door section until it is supported by the support cables. The door steps deploy automatically from their stowed positions.

Closing the door from inside the airplane is accomplished by grasping the support cables of the lower door section, pulling the door up until the top edge is within reach, then grasping the center of the door and pulling inboard until the door is held snugly against the fuselage door frame. Latch the lower door section by rotating the inside handle aft and down. Check that the lower front and rear latches are properly engaged. After the lower door section is secured, grasp the pull strap on the upper door section and pull down and inboard. As the door nears the closed position, pull inboard firmly. Latch the upper door section by unstowing inside handle and rotate the handle down to lock, but do not use excessive force, and then up to stow position. Check front and rear latches are properly engaged.

As an additional safety feature, a cabin door warning light is provided. This light is located in the annunciator panel, refer to Figure 7-9, and is illuminated when the cabin door is not securely latched or the emergency exit/ventilation windows are not securely closed.

CREW DOOR

A crew door is installed on pilot's side providing direct access to the cockpit. The door is hinged at the top and a carry-on ladder is provided to allow easy access. The door warning light on the annunciator panel will illuminate if crew door is not closed.

To enter the airplane, insert screwdriver in slot forward of crew door and rotate clockwise to unlock, pull out on the recessed handle and rotate handle clockwise and raise door to the overcenter position. Following this action, the gas spring telescoping door lift automatically raises the door to the full up position.

Closing the door from inside the airplane is accomplished by grasping the pull strap and pulling down and inboard. As the door nears the closed position, pull inboard firmly to assure engagement of the latching pins. Rotate 'D' handle clockwise to lock position, then rotate safety door lock handle located forward of door to aft position. The crew door should be closed prior to flight and should not be opened in flight.

| |
|----------------|
| WARNING |
|----------------|

REFER TO SECTION 3, EMERGENCY PROCEDURES, FOR PROPER OPERATIONAL PROCEDURES TO BE FOLLOWED IF CREW DOOR SHOULD INADVERTENTLY OPEN IN FLIGHT.

CARGO DOOR

A one-piece cargo door, located forward of the cabin door, allows easy loading of bulk cargo. The outward opening, side-hinged door is latched top and bottom by handles which can't be operated when the cabin door is closed. The door warning light on the annunciator panel will illuminate if the cargo door is not closed.

| |
|----------------|
| WARNING |
|----------------|

***FLIGHT WITH THE CARGO DOOR
OPEN OR REMOVED IS PROHIBITED.***

WINDOWS

Seven windows are provided on each side of the airplane. All windows are non-opening, except the emergency exit/ventilation windows and crew door. A foul weather window is incorporated into both the pilot's and copilot's side windows. The foul weather windows may be opened during all ground operations and in flight. Airspeed is not restricted with the foul weather windows open.

EMERGENCY EXIT/VENTILATION WINDOWS

The second cabin window from the front on the right side and the first cabin window on the left side of the passenger compartment can be opened for emergency exit or for ventilation during ground operations. To open the window, rotate the red handle up and push the window out and up until the window stop holds the window up. The door warning light on the annunciator panel will illuminate if a emergency exit/ventilation window is not closed.

| |
|----------------|
| WARNING |
|----------------|

***REFER TO SECTION 3, EMERGENCY
PROCEDURES, FOR PROPER OPER-
ATIONAL PROCEDURES TO BE FOL-
LOWED IF THE EMERGENCY EXIT
DOOR SHOULD INADVERTENTLY
OPEN IN FLIGHT.***

CONTROL LOCKS

A control column lock is provided to restrict control column movement. This restriction holds the ailerons in a neutral position and the elevators slightly down position, thus preventing damage to the control surfaces in gusty wind conditions.

The rudder can be secured with the rudder gust lock. To engage the lock, center the rudder, ensure the elevator is fully down, then move the external rudder lock handle to the lock position. The rudder lock is disengaged by rotating the external rudder gust lock handle to the unlock position. The rudder lock handle is located below the rudder on left side of tailcone stinger. To preclude takeoff with the lock engaged, a cam in the system disengages the lock when the elevators are raised to the three degrees down elevator position.

| |
|----------------|
| WARNING |
|----------------|

***ENSURE ALL CONTROL LOCKS ARE
REMOVED OR RELEASED BEFORE
STARTING THE ENGINES.***

ENGINE

The Pratt and Whitney Canada Inc. powerplant is a lightweight, free-turbine engine. It utilizes two independent turbines; one driving a compressor in the gas generator section, and the second driving a reduction gearing for the propeller; refer to Figure 7-16.

Inlet air enters the engine through an annular plenum chamber formed by the compressor inlet case where it is directed to the compressor. The compressor consists of three axial stages combined with a single centrifugal stage, assembled as an integral unit. It provides a compression ratio of 7.0:1.

A row of stator vanes located between each stage of compressor rotor blades diffuses the air, raises its static pressure and directs it to the next stage of compressor rotor blades. The compressed air passes through diffuser pipes which turn it ninety degrees in direction. It is then led through straightening vanes into the combustion chamber.

The combustion chamber liner located in the gas generator case consists of an annular reverse-flow weldment provided with varying sized perforations which allow entry of compressed air. The flow of air changes direction to enter the combustion chamber liner where it reverses direction and mixes with fuel. The location of the combustion chamber liner eliminates the need for a long shaft between the compressor and the turbine, thus reducing the overall length and weight of the engine.

Fuel is injected into the combustion chamber liner by 14 simplex nozzles supplied by a dual manifold. The mixture is initially ignited by two spark igniters which protrude into the combustion chamber liner. The resultant gases expand from the combustion chamber liner, reverse direction and pass through the compressor turbine guide vanes to the compressor turbine. The turbine guide vanes ensure that the expanding gases impinge on the turbine blades at the proper angle, with a minimum loss of energy. The still expanding gases pass forward through a second set of stationary guide vanes to drive the power turbine.

The compressor and power turbines are located in the approximate center of the engine with their shafts extending in opposite directions. This provides for simplified installation and inspection procedures. The exhaust gas from the power turbine is directed through an exhaust plenum to the atmosphere via twin exhaust ports provided in the duct.

The engine is flat rated at 500 shaft Horsepower on a standard day at sea level, with 1382 foot-pounds torque at 1900 RPM. The speed of the gas generator (N_g) is the true speed of the compressor side of the engine which is 37,500 RPM at 100 percent speed. Maximum permissible speed of the engine is 38,100 RPM which equals 101.6 percent speed. The turbine speed on the power side of the engine is 33,000 RPM at 100 percent speed, which provides a propeller shaft speed of 1900 RPM at a reduction ratio of 0.0576:1.

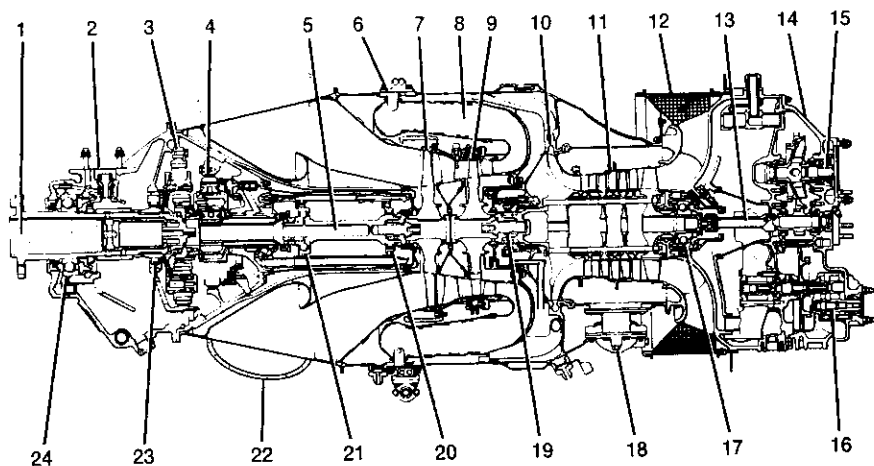
All engine-driven accessories, with the exception of the power turbine (N_p) tachometer-generator and propeller governors, are mounted on the accessory gearbox located at the rear of the engine. These are driven from the compressor by a coupling shaft which extends the drive through a conical tube in the oil tank center section. The rear location of the components provides for a clean engine and simplifies any subsequent maintenance procedures.

The engine oil supply is contained in an integral tank which forms part of the compressor inlet case. The tank has a capacity of 9.2 U.S. quarts and is provided with a dipstick and drain plug.

The power turbine drives the propeller through a two-stage planetary reduction gearbox located at the front of each engine. The gearbox embodies an integral tachometer device which is instrumented to provide an accurate indication of engine power output.

ENGINE CONTROLS

The propulsion system is operated by two sets of three controls for each engine. They consist of the power levers, propeller control levers, and fuel control levers. The power and fuel control levers are engine controls, while the third controls propeller speed.



- | | |
|--|--|
| <ol style="list-style-type: none"> 1. PROPELLER SHAFT 2. PROPELLER GOVERNOR DRIVE PAD 3. SECOND STAGE PLANETARY GEAR 4. FIRST STAGE PLANETARY GEAR 5. POWER TURBINE SHAFT 6. FUEL NOZZLE 7. POWER TURBINE 8. COMBUSTION CHAMBER 9. COMPRESSOR TURBINE 10. CENTRIFUGAL COMPRESSOR IMPELLER 11. AXIAL-FLOW COMPRESSOR IMPELLERS (3) 12. COMPRESSOR AIR INLET | <ol style="list-style-type: none"> 13. ACCESSORY GEARBOX DRIVE SHAFT 14. ACCESSORY GEARBOX COVER 15. STARTER-GENERATOR DRIVE SHAFT 16. OIL SCAVENGE PUMP 17. NUMBER 1 BEARING 18. COMPRESSOR BLEED VALVE 19. NUMBER 2 BEARING 20. NUMBER 3 BEARING 21. NUMBER 4 BEARING 22. EXHAUST OUTLET 23. ROLLER BEARING 24. THRUST BEARING |
|--|--|

Figure 7-16
POWERPLANT SYSTEM

60856020

Power Lever

The power lever in the cockpit is connected through the airframe linkage to the cam-box assembly mounted in front of the Fuel Control Unit at the rear of the engine. The power control lever controls engine power through the full range from maximum takeoff power back through idle to maximum reverse power.

Propeller Control Lever

The propeller control lever in the cockpit is connected through the airframe linkage to the propeller governor mounted on the forward section of the engine. The propeller control lever controls propeller governor settings from the maximum RPM position 1900 RPM to 1600 RPM and full feather.

Fuel Control Lever

The fuel control lever in the cockpit is connected through the airframe linkage to a combined lever and stop mechanism at the top of the Fuel Control Unit; this is connected by the fuel control unit linkage to the unit condition lever on the side of the unit. The lever and stop also function as an idle stop for the fuel control unit control rod. The cockpit lever has two positions only, Run and Cutoff. When the fuel control lever is in the RUN position, the fuel control unit is set to a minimum of 52 percent N_g .

Cowl Flap Control

Two cowl flap controls, refer to Figure 7-7, are located on the control pedestal; one control for each engine. These controls are used to set the cowl flaps in any position from full open to full closed. A locking feature is provided for each control to prevent inadvertent cowl flap position change. Rotating the control clockwise engages the locking mechanism.

Quadrant Friction Lock

A quadrant friction lock, refer to Figure 7-7, is provided to prevent the three primary engine controls (six total levers) from creeping once they have been set. The locking knob (approximately one and one-half inches in diameter) is located on the right side of the pedestal.

ENGINE INSTRUMENTATION

Engine instrumentation for each engine, refer to Figure 7-7, consists of; engine torque indicator, propeller RPM indicator, ITT indicator, N_g percent RPM indicator, fuel flow indicator and oil pressure/temperature indicator. The indicators are placarded as to their operational parameters.

Engine Torque Indicator

The torque indicator displays the torque pressure of the engine in foot-pounds.

Propeller RPM Indicator

The propeller RPM indicator is a tachometer which indicates the propeller speed in revolutions per minute.

ITT Indicator

The interturbine temperature gage displays the air temperature in Celsius between the compressor and power turbines.

N_g Percent RPM Indicator

The N_g RPM indicator indicates the percent of the gas generator RPM to turbine RPM based on a figure of 100 percent N_g at 37,500 RPM.

Fuel Flow Indicator

The fuel flow indicator displays the flow of fuel to the engines. The flow indicator is calibrated in pounds per hour flow. When power is removed from the system the fuel flow indicating pointer will stow below zero in the OFF band.

Oil Pressure/Temperature Indicator

Oil pressure is directly measured and temperature is electrically transmitted and displayed individually on a combination indicator. Oil pressure is presented in pounds per square inch while oil temperature is presented in degrees Celsius. The indicators are marked for their operating parameters.

ENGINE BREAK-IN PROCEDURE

There are no specific break-in procedures required for the Pratt and Whitney Canada Inc. PT6A-112 series turboprop engines. The engines may be safely operated throughout the normal ranges authorized by the manufacturer at the time of delivery of your airplane.

ENGINE OIL SYSTEM

Engine oil, contained in an integral tank between the engine air intake and the accessory case, cools as well as lubricates the engine. An oil radiator located inside the lower nacelle keeps the engine oil temperature within the operating limits. A thermal element is used to regulate the flow of oil through the radiator. Engine oil temperature indicator gives an instantaneous reading of oil temperature. Engine oil also operates the propeller pitch change mechanism and the engine torque meter system.

The lubrication system capacity per engine is 10.4 U.S. quarts. The oil tank capacity is 9.2 U.S. quarts with 5 quarts measured on the dipstick for adding purposes. Recommended oils and oil servicing procedures are covered in Section 8.

IGNITION SYSTEM

The ignition system consists of an ignition monitor light, ignition switch, start and ignition switch, ignition exciter, two high tension leads and two ignitors for each engine.

The two-position ignition switches, refer to Figure 7-24, located on top of the left hand side console are placarded ON and NORMAL. The ignition switches should remain in the NORMAL position for all ground starts and for air starts with starter assist. The ON position is to be used only for air starts without starter assist, heavy precipitation and inadvertent icing encounters until inertial separators are in bypass.

Electrical power will continuously be applied to the ignition exciter when the ignition switch is in the ON position and the battery switch is ON, and will be terminated only when the ignition switch is manually placed to the NORMAL position, or at such time the battery switch is placed in the OFF position. The ignition monitor lights will illuminate at any time power is applied to the ignition exciters.

In the NORMAL position, the ignition exciters will only receive 28VDC power when the left or right IGNITION AND ENGINE START switch is placed to the START position; however, the ignition exciters will continue to receive 28 VDC power and the ignition monitor lights will remain lighted even though the engine has started and the start

cycle has been automatically terminated. The IGNITION AND ENGINE START switches must be manually positioned to the OFF position to inactivate the ignition exciters and to extinguish the ignition monitor lights.

AIR INDUCTION SYSTEM

The engine air inlet is located at the front of the engine nacelle underneath the propeller spinner. Engine exhaust heat is utilized for heating the engine air inlets. Hot exhaust air is picked up by a scoop inside the left exhaust stub, plumbed through the inlet and exits through a scoop in the right hand exhaust stub. No shutoff or temperature indicating system is required for exhaust heated inlet.

INERTIAL SEPARATOR SYSTEM

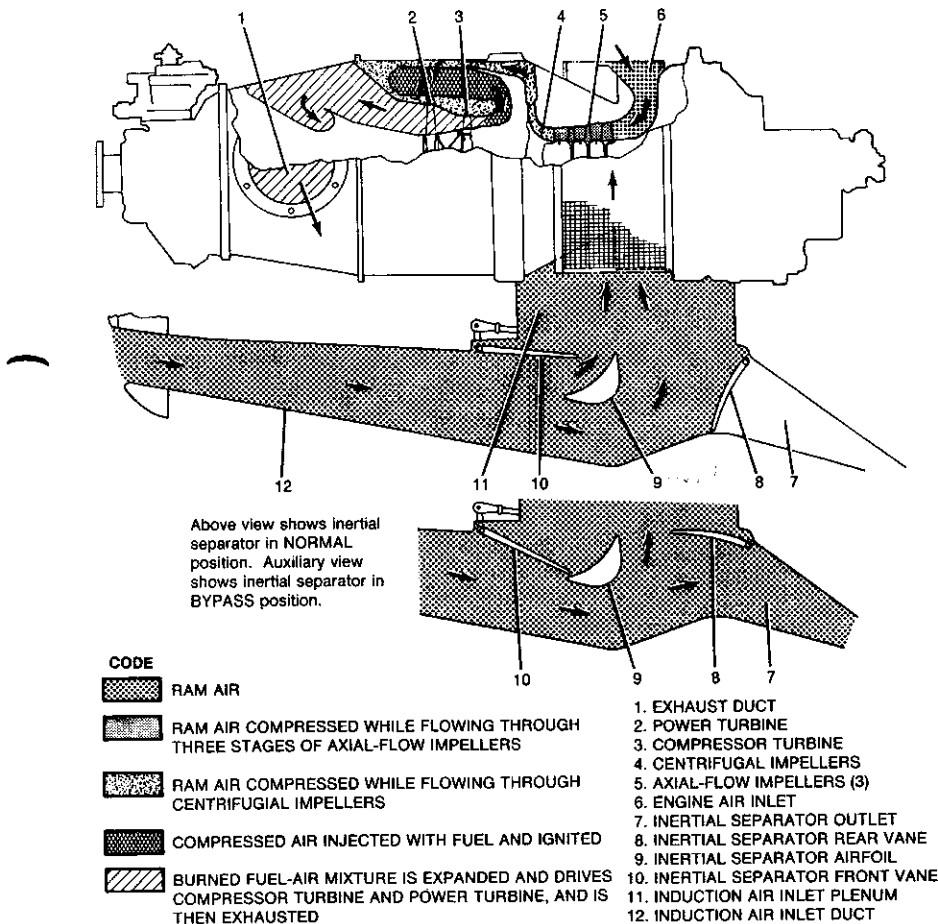
An inertial separator system in the engine air inlet duct prevents moisture particles from entering the compressor air inlet plenum when in bypass mode. Refer to Figure 7-17. The inertial separator consists of two movable vanes and a fixed airfoil which, during normal operation, route the inlet air through a gentle turn into the compressor air inlet plenum. When separation of moisture particles is desired, the vanes are positioned so that the inlet air is forced to execute a sharp turn in order to enter the inlet plenum. This sharp turn causes any moisture particles to separate from the inlet air and discharge overboard through the inertial separator outlet in the left side of the cowling.

The inertial separator system is electrically actuated. Normal operation of the inertial separator system while in the bypass mode is indicated by green annunciator lights, L INERTIAL SEP or R INERTIAL SEP and a decrease in torque and increase in ITT will also be encountered.

The engine inlet duct is not protected by a filtering device. The engine air inlets are protected by a screen which will prevent entry of large articles, but does not filter the inlet air.

EXHAUST SYSTEM

The exhaust system consists of an exhaust stub fitted to the left and right side of the engine just aft of the propeller reduction gear box. The exhaust stubs are directed aft to utilize the remaining energy of the gases in the form of thrust for additional aircraft propulsion.



60856002

**Figure 7-17
ENGINE AIR FLOW**

COWL FLAPS

The cowl flaps are located just aft of the inertial separator. The cowl flaps when in the open position allows an increase in air flow through the engine oil cooler, thus cooling the engine oil. The cowl flaps are operated by push-pull controls located on the control pedestal.

STARTING SYSTEM

Each engine is started by a three-position switch located on top of the left side console, refer to Figure 7-23. The switch is placarded **IGNITION AND ENGINE START - OFF - MOTOR ONLY**. Each switch may be placed to the **MOTOR ONLY** position for clearing fuel from the engine without having the ignition circuit activated. Placing the switch to the **START** position will activate both the starter and ignition exciter which will in turn activate the appropriate **IGNITION ON** annunciator light. When engine speed reaches 41 percent N_g the start cycle will automatically be terminated by a speed sensing switch located in the starter/generator. The starting sequence may be manually terminated at any point during the start by resetting the toggle switch to the **OFF** position and placing the fuel control lever in the **CUTOFF** position. The **IGNITION AND ENGINE START** switches must be manually placed to the **OFF** position to inactivate the ignition exciter and to extinguish the ignition monitor light, even though the start cycle has been automatically terminated and the engine has started.

ENGINE ACCESSORIES

All engine-driven accessories with the exception of the tachometer-generator and propeller governors are mounted on the accessory gear box located at the rear of the engine. These are driven from the compressor by a coupling shaft which extends the drive through a conical tube in the oil tank center section.

Oil Pump

Pressure oil is circulated from the integral oil tank, through the engine lubricating system, by a self-contained gear type pressure pump located in the lowest part of the oil tank. The oil pump is comprised of two gears, contained in a cast housing which is bolted to the front face of the accessory diaphragm, and is driven by the accessory gearshaft. The oil pump body incorporates a circular mounting boss to accommodate the check valve, located in the end of the filter housing. A second mounting boss on the pump accommodates the pressure relief valve.

Fuel Pump

The fuel pump is mounted on the accessory gearbox and is driven through a gearshaft and splined coupling. The coupling splines are lubricated by oil mist from the auxiliary gearbox through a hole in the gearshaft. Another splined coupling shaft extends the drive to the fuel control unit which is bolted to the rear face of the fuel pump. Fuel from the airplane boost pump enters the fuel pump through a 74-micron (200 mesh) inlet screen, and then to the pump gear chamber from where the fuel is delivered at high pressure to the fuel control unit through a 10-micron pump outlet filter. A bypass valve and cored passages in the pump casing enable unfiltered high pressure fuel to flow from the pump gears to the fuel control unit when the outlet filter is blocked. An internal passage originating at the mating face with the fuel control unit returns bypass fuel from the fuel control unit to the pump inlet downstream of the inlet screen. A pressure regulating valve in this line serves to pressurize the pump gear bushings.

Hydraulic Pump

The hydraulic pump is an engine-driven constant displacement pump that is mounted on the accessory gear box of the engine. The pump delivers a pressure of 1750 pounds per square inch gage and uses MIL-H-5606 hydraulic fluid.

Tachometer - Generator - Gas Generator (N_g)

The tachometer-generator produces an electric current which is used in conjunction with a tachometer to indicate gas generator RPM. The tachometer-generator drive and mount pad is located at the 5 o'clock position on the accessory gearbox and is driven from the internal scavenger pump. Rotation is counterclockwise with a drive ratio of 0.112:1.

Tachometer - Generator - Power Turbine (N_t)

The power turbine tachometer-generator operates in the same manner as that of the gas generator. However, the turbine tachometer-generator drive and mount pad is located on the right side of the reduction gearbox case and rotates clockwise with a drive ratio of 0.1273:1. Propeller rpm (N_p) is directly proportional to power turbine speed (N_t) by taking into account the reduction ratio in the reduction gear box of 0.0575:1.

Torque Transducer

The torque transducer indicating system is a measuring device which provides an accurate indication of the torque being produced by the power turbine. The torque transducer receives a high and low oil pressure input and converts the differential pressure into an electrical voltage which is the input to the engine torque indicator.

Electrical Power Source

Electrical power is supplied by two 28 Volt DC 250 ampere engine driven starter/generators. One 24 volt nickel cadmium battery is installed for starting and emergency requirements. A receptacle has been provided on the lower fuselage aft of the cabin entry door for connection of an external power unit.

Engine Overspeed Governor

Engine overspeed governing is controlled by the primary propeller governor and the fuel metering unit. In the event of a power turbine overspeed condition, a governing orifice in the primary propeller governor is opened by flyweight action of the propeller governor, to bleed off compressor discharge pressure through the governor and computing section of the fuel control unit to the atmosphere. When this occurs, compressor discharge pressure acting on the fuel control unit governor bellows decreases and moves the metering valve in a closing direction thus reducing fuel flow to the flow divider.

Propeller Overspeed Governor

A propeller overspeed governor, mounted on the left side of the reduction gear housing, acts as a safeguard against propeller overspeed should the primary propeller governor fail. The propeller overspeed governor regulates the flow of oil to the propeller pitch-change mechanism by means of a flyweight and speeder spring arrangement similar to the primary propeller governor. Since it has no mechanical controls, the overspeed governor is equipped with a test solenoid that resets the governor below its normal overspeed setting for ground test. The overspeed governor test switch is located on the left side console.

Propeller Synchrophaser

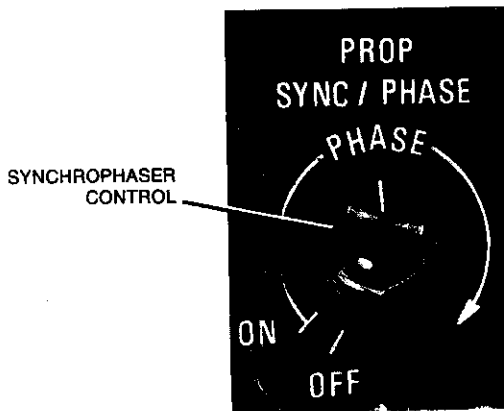
The propeller synchrophaser, refer to Figure 7-18 automatically matches RPM of the two engines and allows the pilot to select any desired phase relationship between the two propellers. The RPM of one engine will follow changes in the RPM of the other engine over a limited range. This limited range feature prevents either engine from losing more than a fixed amount of RPM in case the other engine is feathered with the synchrophaser ON. In no case will the RPM follow below that

selected by the propeller control lever. Normal governor speed setting control and procedures are unchanged but the synchrophaser will trim the governor speed settings to exactly match each other.

NOTE

● *Manually synchronize the RPM of the engines prior to switching the propeller synchrophaser system ON.*

● *The propeller synchrophaser must be switched off during takeoff and landing and one engine inoperative operation.*



6085P6007

Figure 7-18
PROPELLER SYNCHROPHASER

Interturbine Temperature Sensing System (T₅)

The interturbine temperature sensing system (T₅) is designed to provide the operator with an accurate indication of engine operating temperatures taken at a point between the two turbines. The system consists of twin leads, two bus bars and eight individual chromel-alumel thermocouple probes connected in parallel. Each probe protrudes through a threaded boss on the power turbine stator housing into an area adjacent to the leading edge of the power turbine vanes. The probe is secured to the boss by means of a floating, threaded fitting which is part of the thermocouple probe assembly. Shielded leads connect each bus bar assembly to a terminal block which provides a connecting point for external leads to a cockpit instrument.

ENGINE SHOCK MOUNTS

Each engine is elastomerically mounted to engine truss at three points. The truss attaches to the wing leading edge and aft nacelle in four places.

FIRE DETECTION AND EXTINGUISHING SYSTEM

Each engine fire detection and optional extinguishing system consists of two heat sensors located in the engine compartment, a compressed gas, single-shot fire bottle located in the main gear well and two annunciator/actuators located on the annunciator panel.

When the annunciator panel PRESS-TO-TEST button is pressed, the fire warning lights should illuminate. During normal operation, if an overheat condition should occur, the applicable fire warning light will illuminate. Lifting the clear plastic cover guard and pressing the red fire annunciator will close the bleed air valve, fuel firewall shutoff valve and disable the generator and arm the optional fire extinguishing system. Pressing the white fire bottle armed light will deploy the fire extinguisher contents into the engine compartment. After the engine compartment cools, the red fire warning light will extinguish.

NOTE

For operation with one bleed air shutoff valve closed or one engine inoperative, power above flight idle may be required on the operating engine to maintain gyro pressure in the green arc.

PROPELLER

The airplane is equipped with all-metal, three-bladed, constant-speed, full-feathering, single-acting, governor-regulated propellers. Each Propeller utilizes oil pressure which opposes the force of springs and counterweights to obtain correct pitch for engine load. Oil pressure from the

propeller governor drives the blades toward low pitch (increasing RPM) while the springs and counterweights drive blades toward high pitch (decreasing RPM). The source of oil pressure for propeller operation is furnished by the engine oil system, boosted in pressure by the governor gear pump, and supplied to the propeller hub through the engine shaft flange.

To feather the propeller blades, the propeller control levers on the control pedestal must be placed in the feather position. Unfeathering the propeller is accomplished by positioning the propeller control lever to the minimum or higher RPM position. The unfeathering system uses engine oil pressure to force the propeller out of feather and into the low pitch condition.

An autofeathering system provides for automatic feathering of a propeller in the event of loss of the engine. The system is controlled by an arming switch with ARM, OFF and TEST positions. In the OFF position, the system is deactivated. In ARM, the propeller will automatically feather if engine torque drops below approximately 185 foot-pounds at power lever positions of 80 percent N_g or greater. Autofeathering of one propeller disarms the system on the other propeller. L and R AUTO-FEATHER ARM annunciator lights will illuminate when system is armed. TEST is a momentary position and provides for a check out of the system with power below 80 percent N_g . The system is primarily intended for use during takeoff and climb.

Reversed propeller pitch is available for increased landing ground roll stopping capability. To accomplish reverse pitch, the power levers are retarded beyond IDLE over the gate and into the BETA position. Full reverse-pitch is accomplished by retarding the power levers to the MAX REVERSE position. Control of propeller speed is achieved through control of blade angle. An externally grooved feedback ring is provided with the propeller. Motion of the feedback ring is proportional to propeller blade angle, and is picked up by a carbon block running in the feedback ring. The relationship between the axial position of the feedback ring and the propeller blade angle is used to maintain control of blade angle from flight idle to full reverse.

CAUTION

*THE PROPELLER REVERSING LINKAGE
CAN BE DAMAGED IF THE POWER LEVER
IS MOVED AFT OF THE IDLE POSITION
WHEN THE ENGINE IS NOT RUNNING
AND THE PROPELLER IS FEATHERED.*

Overspeed Governor Test Switch

An overspeed governor test switch is located on the left side of the instrument panel. The switch is the push-to-test type and is used to test the propeller overspeed governor during engine run-up. The switch, when depressed, actuates a solenoid on the propeller overspeed governor which restricts propeller RPM when the power lever is advanced. To check for proper operation of the overspeed governor, during engine run-up, depress the press-to-test switch and advance the power lever until propeller RPM stabilizes; propeller RPM should not exceed 1725 ± 50 RPM.

FUEL SYSTEM

The fuel system, refer to Figure 7-19, consists of left and right fuel tanks, crossfeed system, engine fuel system, quantity and flow instrumentation and necessary lines, controls, valves, pumps, etc., to complete the system.

FUEL TANKS

The fuel tanks are an integral portion of the sealed wet wing. Each tank supplies fuel to its respective engine for all operations except crossfeeding.

Each fuel tank contains a fuel filler, feed and vent lines, fuel quantity measuring systems, drain valves, a hopper tank, transfer ejector pumps, main ejector pump, electric boost pump and other required hardware to complete the system

Each fuel tank is serviced through a flush filler located in the top outboard surface of each wing.

The funnel-shaped hopper is located in the inboard end of each main tank, see Figure 7-20. The hopper tank is supplied from the remainder of the wing tank by either gravity flow or by transfer ejector pumps.

The transfer ejector pumps, located in the forward and aft inboard end of each fuel tank, transfer fuel from the lowest points of each fuel tank to the hopper. These ejector pumps utilize existing fuel pressure in conjunction with a venturi to produce a high-volume flow. As the high pressure fuel (motive flow) is forced through the ejector orifice, a low pressure area is created at the pump inlet, drawing in a comparatively large volume of fuel and pushing it out at low pressure. Motive flow for operation of the transfer ejector pumps is provided whenever the respective auxiliary boost pump is in operation. Scavenging of fuel from the lowest points of each fuel tank ensures the maximum usable fuel in all normal flight attitudes.

The amount of unusable fuel is minimal due to the design of the fuel system. Refer to Section 2, Fuel Limitations, for maximum unusable fuel quantity and flight conditions.

During normal or one engine inoperative flight operations, fuel can be used from either tank through the use of the fuel crossfeed selector switch. If crossfeed operation is initiated with nearly full fuel tanks, it must be remembered that during crossfeed operation the excess fuel not required by the engines (500 to 800 pounds per hour) will be transferred to the opposite fuel tank. The unused tank quantity should be monitored to prevent overflow. Use of fuel from the right and left tanks alternately will maintain fuel balance.

DRAIN VALVES

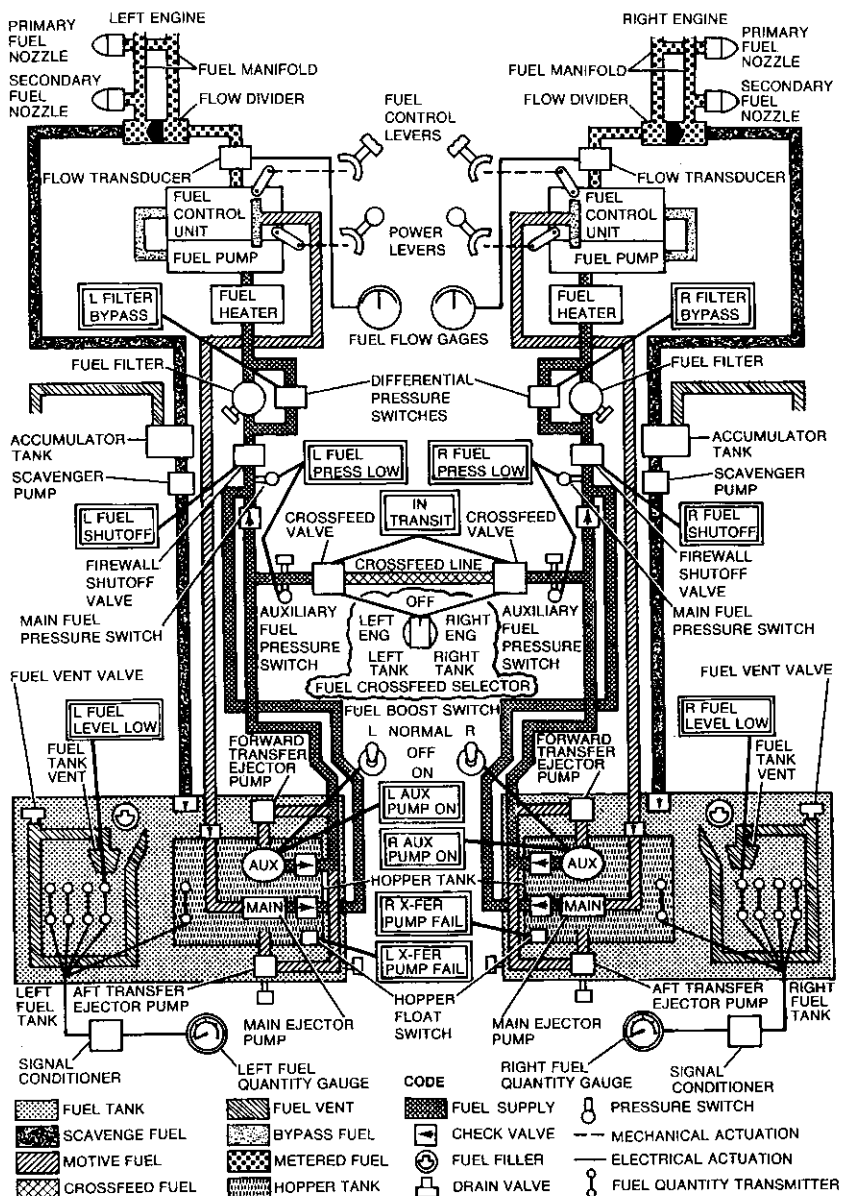
Two drain valves are located in the lower surface of each fuel tank, one in each crossfeed line and one in each fuel filter. The valves allow draining of sediment, moisture and/or residual fuel from the tank, filter and crossfeed lines. The spring-loaded poppet is housed in the drain valve body and is spring-loaded to the closed position. A slot in the end of the drain valve allows for a phillips-screwdriver operation of the valve to the OPEN position.

FUEL INDICATING SYSTEM

The fuel quantity indicating system consists of left and right fuel quantity system. The system is a capacitance, temperature compensated system. Each wing fuel tank is gaged separately by the fuel probes, located in the wing tank and hopper tank. The fuel probes are connected to the signal conditioner in the wing and then to the fuel quantity indicator on the instrument panel. Each fuel quantity gage operates on 28 VDC power supplied through circuit breakers. There are five fuel probes located in each wing fuel tank, four in the outboard wing tank and one each hopper tank. The fuel quantity indicator is calibrated in pounds and will indicate the weight of fuel contained in each fuel tank. The indicator reads from 0 - 1800 pounds fuel quantity with an OFF position located under the zero pounds marking. When electrical power is removed from the indicator the needle will indicate the OFF range. The fuel flow is metered by the fuel control unit and is indicated in 10 pound increments with a range from 0 - 500 pounds of fuel flow per hour.

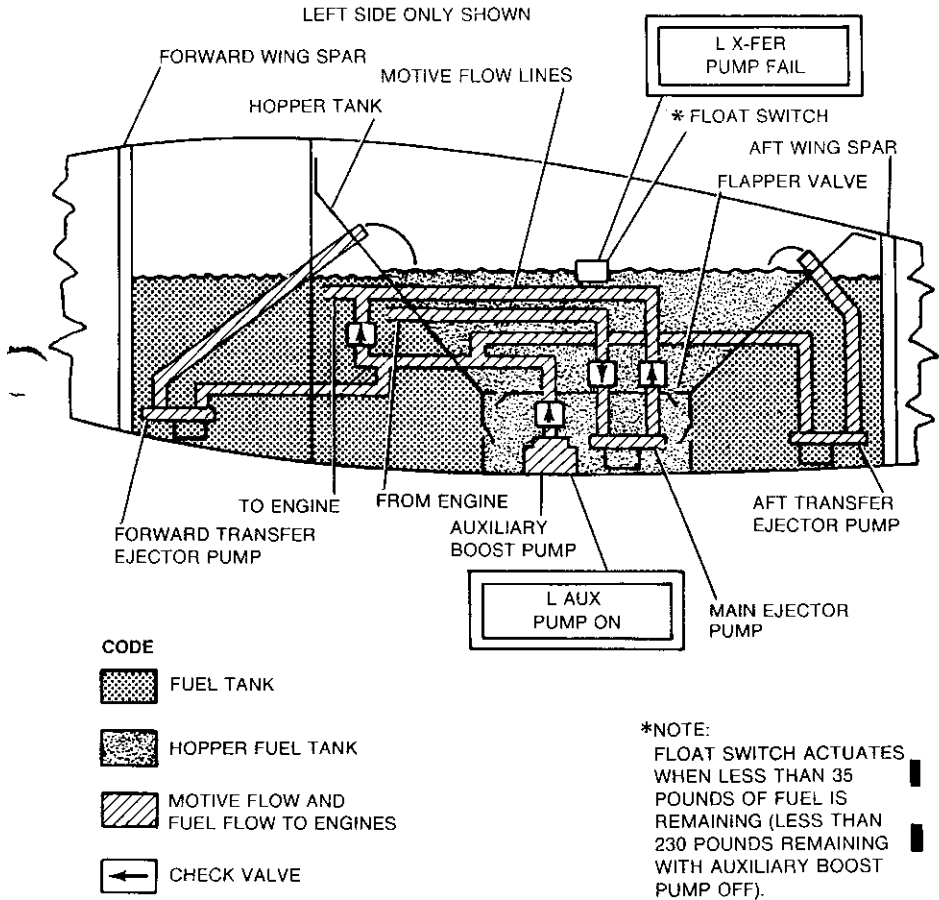
FUEL PUMPS

Main ejector pump and auxiliary DC boost pump are located in the bottom of each hopper tank, ensuring an adequate fuel supply to the selected engine(s). The main ejector pump is operated by motive flow supplied continuously from the engine fuel control whenever the engine



60857003

Figure 7-19
FUEL SYSTEM SCHEMATIC



60856001

Figure 7-20
WING FUEL HOPPER TANK SCHEMATIC

is operating. The ejector pumps do not have sufficient flow and pressure capacity for crossfeeding or supplying the transfer ejector pump motive flow. The auxiliary DC boost pump supplies fuel to its respective engine in the event of main ejector pump failure or when using aviation gasoline, to supply motive flow to the transfer pumps at low fuel levels, and to supply fuel for crossfeed operations. Failure of either pump will be indicated by illumination of the applicable left or right FUEL PRESS LOW annunciator light which is activated by separate main and auxiliary pressure switches.

CAUTION

THE AUXILIARY BOOST PUMPS SHOULD NOT BE OPERATED UNLESS SPECIFICALLY REQUIRED FOR THE OPERATION BEING CONDUCTED SINCE INADVERTENT DRY RUNNING OF THE PUMPS WILL DAMAGE THEM.

The two three-position boost pump switches, one each for left and right fuel systems are located on the left console. When the switch is in NORMAL position, with crossfeed off, the main ejector pump operates and the auxiliary boost pump does not operate but the circuitry is armed to automatically activate the auxiliary boost pump after a 3-second delay when the main fuel pressure switch senses low pressure, or when the hopper float switch senses a low fuel level. When the boost pump switch is in NORMAL position, with crossfeed ON, both main ejector pumps operate, the auxiliary boost pump in the feeding tank operates and the auxiliary boost pump in the non-feeding tank does not operate. OFF position on the boost pump switch operates the main ejector pump and the auxiliary boost pump does not operate. ON position operates the main ejector pump and the auxiliary boost pump. The scavenger pump operates whenever the boost pump switch is in the ON position.

NOTE

Each main ejector pump operates continuously when its respective engine is running. When a main pump and an aux pump are both operating simultaneously, whether during normal operation or crossfeeding, the pressure from the aux pump is sufficient to override the main pump, causing its discharge check valve to close and its motive flow to dump into the tank through the ejector pump inlet.

VENT SYSTEM

Fuel tank venting is accomplished by a multiple point open vent system installed in each wing tank. Components include a float valve (air/no fuel) at the outboard end of each tank, which accomplishes all venting functions in most conditions, two check valves at the rear inboard and outboard portions of the tank, which permit air inflow during attitude and fuel level conditions when the float valve is closed, and an open tube end in the inboard end of the tank, which provides fail safe venting in case of over flow of a full tank or component failure conditions. In addition, a vented fuel filler cap and a siphon breaker tube are provided.

CROSSFEED SYSTEM

The crossfeed system, refer to Figure 7-19, consists of a single crossfeed line interconnecting each nacelle, two crossfeed valves, a 3-position crossfeed selector switch and necessary wiring and plumbing to complete the system.

When the crossfeed selector is positioned to OFF, both crossfeed valves are closed, allowing no fuel to flow from one side of the airplane to the other side. A green IN TRANSIT light adjacent to the crossfeed selector switch illuminates whenever the crossfeed valves are not fully opened or closed or do not coincide with the selector switch position. Refer to Section 8 for in-transit light bulb replacement information.

In the LEFT ENG position and the fuel boost pump in normal position, both engines feed from the right fuel tank. To accomplish this both crossfeed valves are electrically opened, the left auxiliary boost pump is deenergized and the right auxiliary boost pump is energized. With both right main ejector and right auxiliary boost pumps operating, sufficient fuel flow is available to assure continued normal operation of both engines at all power settings. Excess fuel leaving the right fuel tank and not required by the engines will be transferred to the left fuel tank. This transfer rate is normally 500 to 800 pounds per hour during the crossfeed operation.

In the RIGHT ENG position and the fuel boost pump in normal position, both engines feed from the left fuel tank. To accomplish this both crossfeed valves are electrically opened, the right auxiliary boost pump is deenergized and the left auxiliary boost pump is energized. With both left main ejector and left auxiliary boost pumps operating, sufficient fuel flow is available to assure continued normal operation of both engines at all power settings. Excess fuel leaving the left fuel tank and not required by the engines will be transferred to the right fuel tank. This transfer rate is normally 500 to 800 pounds per hour during the crossfeed operation.

FIREWALL SHUTOFF VALVE SWITCHES

The fuel firewall shutoff valve controls are integrated into the engine fire detect and extinguishing controls located above the annunciator panel.

FUEL FLOW GAGES

The left and right fuel flow gages, refer to Figure 7-7, indicate the fuel consumption of each engine in pounds per hour. When power is removed from the gage, the needle will indicate in the OFF range.

FUEL QUANTITY GAGE

A capacitance-type fuel quantity gage, refer to Figure 7-7, is provided for each set of fuel tanks. The gages are calibrated in pounds and accurately reflect the weight of fuel contained in each set of fuel tanks. When power is removed from the gage, the needle will indicate in the OFF range. An optional fuel flow totalizer, located just above the pedestal, displays the amount of fuel in pounds that have already been consumed.

FUEL LEVEL LOW WARNING LIGHTS

The L and R FUEL LEVEL LOW warning lights, refer to Figure 7-9, provide a warning when the left and/or right fuel tanks contain approximately 160 pounds of fuel. These lights are actuated by float switches located in each fuel tank. Each light operates independently from the fuel quantity indicating system.

ENGINE FUEL SYSTEM

The engine fuel system, refer to Figure 7-19, obtains fuel from the selected main tanks and delivers it to the engine for all phases of operation. The engine fuel and control system includes a fuel control unit, pumps, filters, flow divider and drain valve and fuel manifold and nozzle assemblies. The system provides fuel flow to satisfy the speed and power demands of the engine.

The fuel manifold and nozzle assemblies, deliver fuel to the combustion chamber through 14 primary and secondary fuel nozzles. The primary nozzles are for starting and initial acceleration. During all other phases of operation, fuel is provided by both primary and secondary nozzles. The flow divider schedules the metered fuel from the fuel control unit between the primary and secondary fuel manifolds as a function of primary manifold pressure.

A fuel scavenge system is provided for the recovery of excess fuel contained in the engine fuel manifold after engine shutdown. Upon engine shutdown, excess fuel gravity feeds from the flow divider drain valve into a canister. Whenever the fuel boost pump switches are positioned to ON, as in the next engine start, the scavenge pump will operate and pump this fuel from the canister back into the main fuel tanks.

Fuel Heater

An oil to fuel heat exchanger heats the fuel supply to facilitate proper operation of the fuel control unit. Fuel heater operation is automatically controlled by a thermostatic bypass valve.

Fuel Control Heaters

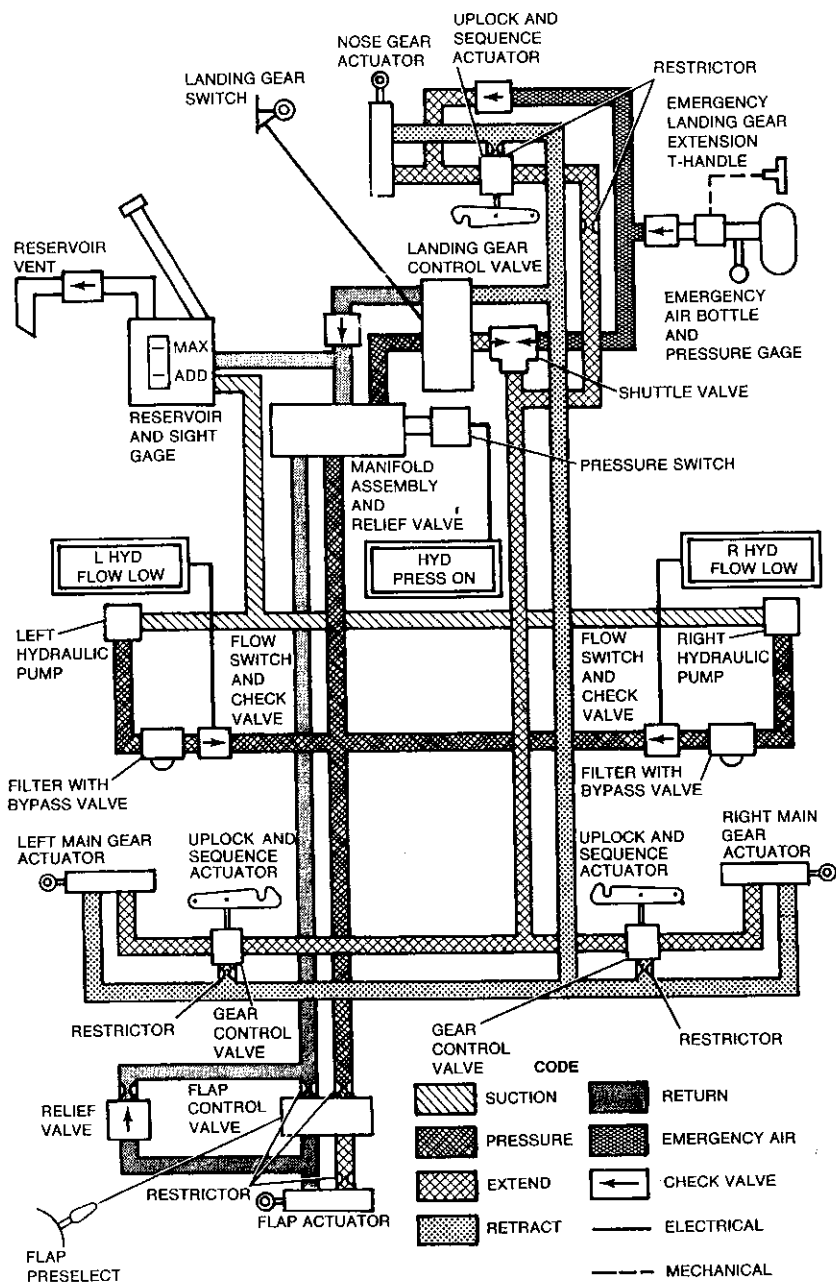
Electrical heating elements are provided to prevent moisture freezing in the fuel control system pneumatic sensing lines. The heaters are controlled by switches, one for each engine. Heaters should be on for all engine operations.

HYDRAULIC SYSTEM

The hydraulic system, refer to Figure 7-21, supplies hydraulic pressure to the landing gear and wing flap systems which are electrically controlled and hydraulically actuated. Refer to Wing Flaps System and Landing Gear System in this section for a complete description and operation of their respective systems. For malfunction of the hydraulic system, refer to Section 3, Emergency Procedures.

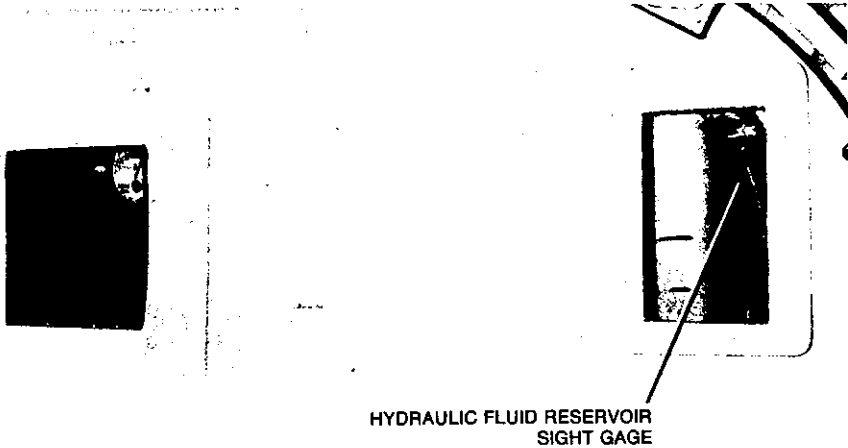
Hydraulic pressure is supplied by the hydraulic pump which is mounted on each engine. The hydraulic reservoir, located in the nose baggage compartment, refer to Figure 7-22, incorporates a sight gage for checking the fluid level while the gear is extended.

The hydraulic system also includes a hydraulic pressure light and a left and right hydraulic low flow light, refer to Figure 7-9. The HYD PRESS ON indicator light will remain illuminated until the wing flaps reach their selected position and/or the landing gear is locked into selected position. The L and R HYD FLOW LOW lights illuminate in the event of a hydraulic pump, line failure or low flow (low engine RPM).



60857002

Figure 7-21
HYDRAULIC SYSTEM SCHEMATIC



VIEW LOOKING AFT THROUGH LEFT NOSE BAGGAGE DOOR

6085P6015

Figure 7-22
HYDRAULIC RESERVOIR SIGHT GAGE

BRAKE SYSTEM

The airplane is provided with an independent hydraulically actuated brake system for each main wheel. A hydraulic master cylinder is attached to each pilot's rudder pedal. Hydraulic lines and hoses are routed from each master cylinder to the wheel cylinder on each brake assembly. No manual adjustment is necessary on these brakes. The brakes can be operated from either pilot's or copilot's pedals. The parking brake system consists of a manually operated handle assembly, refer to Figure 7-7, connected to the parking brake valves located in each main brake line. When pressure is applied to the brake system and the parking brake handle is pulled and relocked, the valve holds pressure on the brake assemblies until released. To release the parking brakes, unlock, push in the parking brake handle and relock handle. It is not necessary to depress the rudder pedals when releasing the parking brake.

ELECTRICAL SYSTEM

Electrical energy, refer to Figure 7-23, is supplied by a 28-volt, negative-ground direct current system powered by a 250 amp starter-generator on each engine. The electrical system has independent circuits for each side with each generator having its own regulator and overvoltage protection relay. The voltage regulators are connected to provide proper load sharing. When the battery switch is OFF, power is only

provided to select items by the emergency bus. These items include the digital clock, cabin and cockpit lighting, optional nose baggage area lighting and nacelle baggage lighting. In addition, a "frequency memory" voltage is provided to each nav, com, ADF and optional ARC RNAV to retain their respective frequency memories. Generator failure lights, battery overheat lights and system voltmeter and ammeters are provided to allow electrical system monitoring.

NOTE

Ensure all circuit breakers are engaged and serviceable fuses are installed before all flights. Never operate with any blown fuses or disengaged circuit breakers without a thorough knowledge of the consequences.

BATTERY

A 39 ampere-hour nickel-cadmium battery is located in the right nose baggage compartment under the upholstered floor panel. Access to the battery disconnect is gained by folding back the carpeting and opening the access door.

Starting the engines with an external power source is a highly recommended practice that should be exercised whenever possible to prolong the life of the battery and to conserve battery power for times when battery starts must be accomplished. When it is anticipated that the airplane will be idle for a period of more than two days, it is advisable to disconnect the battery to prevent frequency memory circuits or other equipment that may be powered by the emergency bus from draining the battery. Installed equipment containing frequency memory circuits must be reset any time the battery is disconnected as the loss of electrical power will disable the memory function.

Proper care of the battery is extremely important and will normally ensure availability of adequate cranking power for engine starts. The battery should be inspected and serviced in accordance with requirements defined in the Airplane Maintenance Manual, which specify that the electrolyte must be checked every 50 flight hours, and the battery must be reconditioned every 100 flight hours. Operating conditions that require numerous starts and short engine operating times may necessitate more frequent servicing of the battery to maintain peak efficiency and to prolong battery life.

BATTERY AND GENERATOR SWITCHES

Separate battery and generator switches, refer to Figure 7-24, are provided as a means of checking for a malfunctioning generator circuit and to permit such a circuit to be turned off. If a generator circuit fails or malfunctions, or when one engine is not running, the switch for that

generator should be turned off. Operation should be continued on the functioning generator, using only necessary electrical equipment. If both generator circuits should malfunction, equipment can be operated at short intervals on the battery alone. In either case, a landing should be made as soon as practical to check and repair the circuits.

GENERATOR CONTROL UNITS

The generator control units regulate the starter-generator modes of operation. Below 41 percent RPM, each starter-generator operates as a starter. Above 41 percent RPM, each starter-generator operates as a generator. Should a generator exceed the normal operating voltage, the generator control unit will take the affected generator off the line.

VOLTMETER AND AMMETERS

A voltmeter and 2 ammeters, refer to Figure 7-7, are located on the left stationary instrument panel. These indicators continuously display bus voltage and right and left generator output in amperes. A two-position selector switch (spring loaded to L GEN), adjacent to the voltmeter and ammeters, allows left generator output or battery charge rate to be displayed. In the normal position (L GEN), the left ammeter displays left generator output. In the BATT position, the left ammeter will display battery charge rate.

CIRCUIT BREAKERS, SWITCH BREAKERS AND FUSES

Electrical systems in the airplane are protected by push-to-reset type circuit breakers or switch breakers, refer to Figure 7-24. Should an overload occur in any circuit, the resulting heat rise will cause the controlling circuit breaker to "pop" out, opening the circuit or allowing the switch breaker to return to the OFF position. After allowing to cool for approximately three minutes, the circuit breaker may be pushed in (until a click is heard or felt) or the switch breaker may be returned to the ON position to reenergize the circuit. For identification, deice and anti-ice breakers are capped in green. Fuses, located in the nose section, protect the emergency bus circuits.

SPARE FUSES

Spare fuses are located in a spare fuse bag located under the battery door in the nose section. Refer to Section 8 for fuse location, application, and changing instructions. Installing fuse limiters requires use of specific torque. Refer to the Airplane Maintenance Manual for torque values.

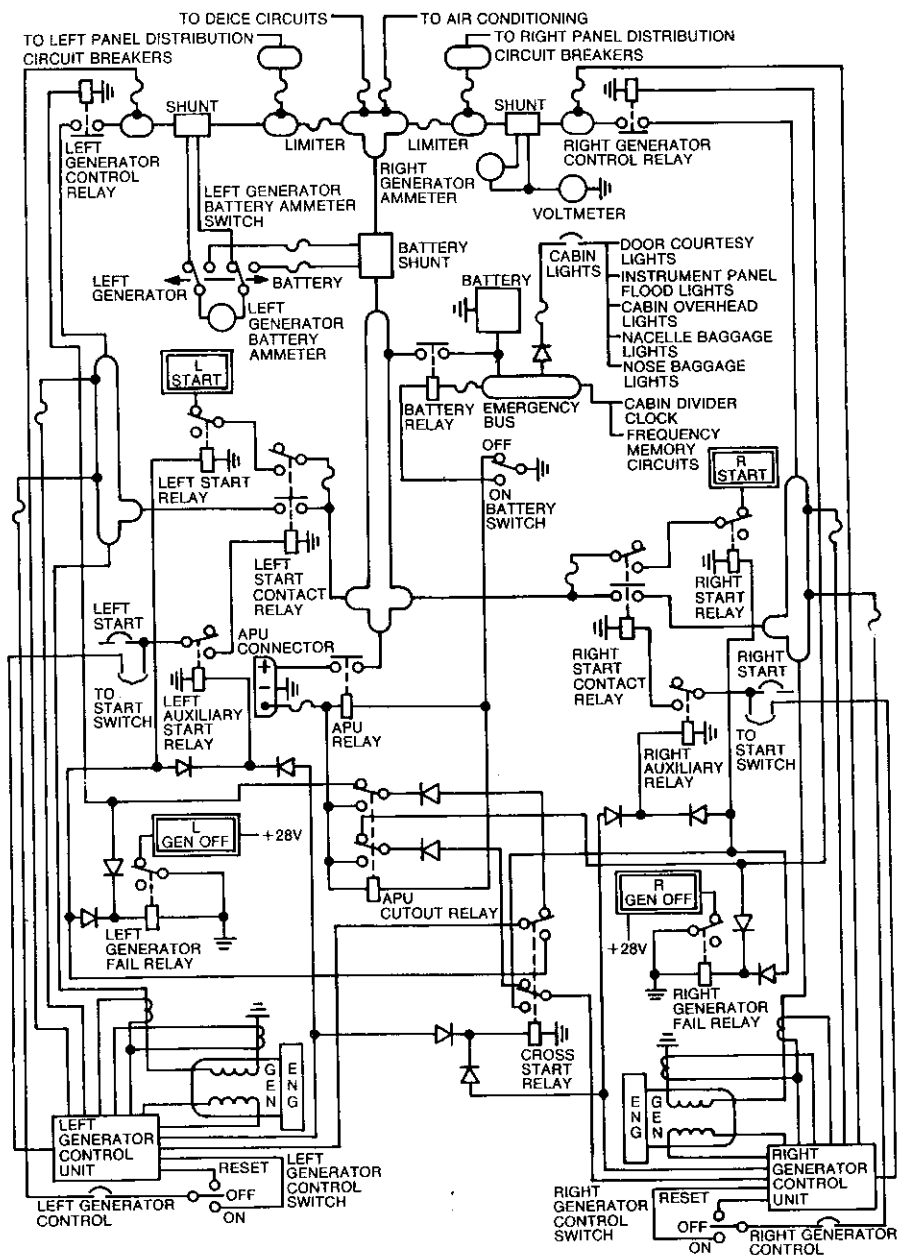
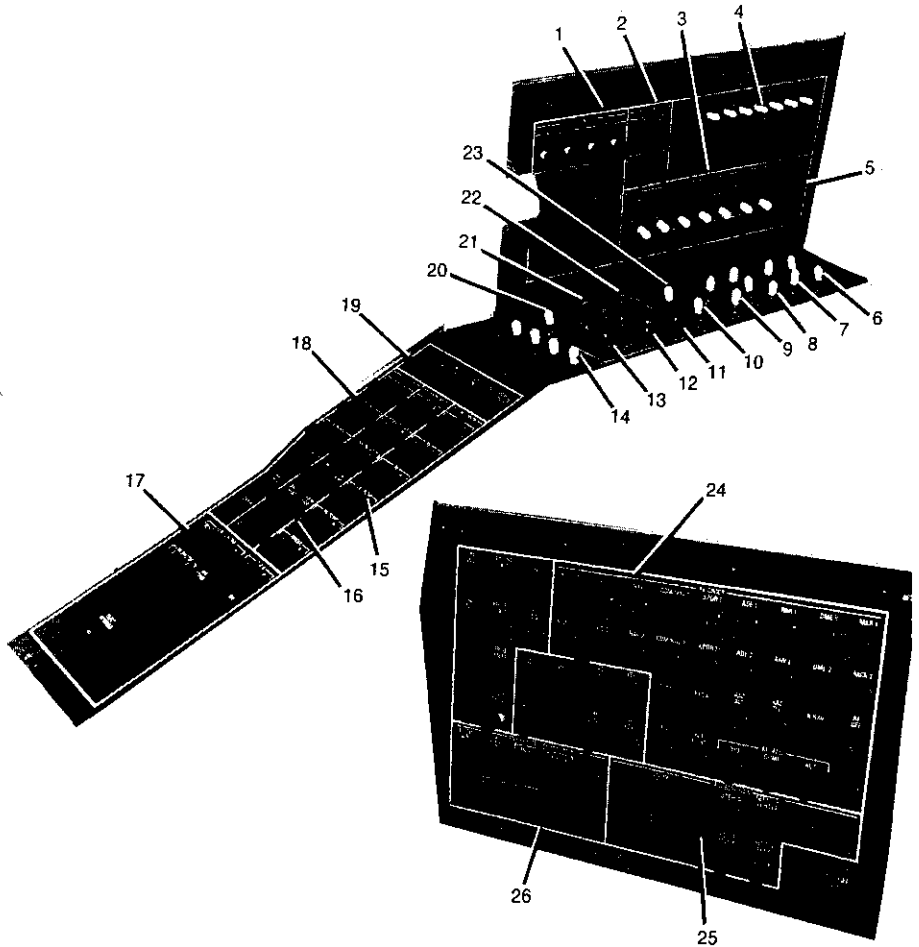


Figure 7-23
ELECTRICAL SYSTEM SCHEMATIC

60857009



6085P 6002
6085P 6003

- 1. ENGINE & FUEL
- 2. FIRE DETECTION
- 3. LIGHTING
- 4. INTERNAL & COCKPIT LIGHTS
- 5. EXTERNAL LIGHTS
- 6. IGNITION
- 7. STARTING
- 8. GENERATORS & BATTERY
- 9. FUEL BOOST
- 10. AUTOFEATHER
- 11. STALL VANE HEATER
- 12. INERTIAL SEPARATOR
- 13. FUEL HEATERS

- 14. AVIONICS BUS
- 15. ENGINE INSTRUMENTS
- 16. WARNINGS
- 17. GENERATOR CONTROLS
- 18. LIGHTING SYSTEMS
- 19. SYSTEMS
- 20. INVERTER SWITCH
- 21. PROPELLER DEICE
- 22. PITOT STATIC HEATER
- 23. OVERSPEED GOVERNOR
- 24. AVIONICS SYSTEMS
- 25. ACCESSORIES
- 26. ENVIRONMENTAL

**Figure 7-24
LEFT AND RIGHT SIDE CONSOLES (TYPICAL)**

AC POWER

The AC system consists of a dynaverter used to power avionics equipment. The dynaverter, located in the nose avionics compartment, is utilized to change 28 VDC to 26 and 115 VAC 400 Hz for operation of avionics equipment. The AC power is supplied to the autopilot or optional IFCS, Attitude Gyro and the RMI. Other optional systems using AC have separate inverters.

The AC system is controlled by the inverter switch, located on the left side console, refer to Figure 7-7. An AC FAIL light on the annunciator panel indicates AC power malfunction.

EXTERNAL POWER RECEPTACLE

An external power receptacle is installed on the bottom of the fuselage just aft of the main cabin door. The receptacle accepts a standard external power source plug.

LIGHTING SYSTEMS

EXTERNAL LIGHTING

The airplane is equipped with three navigation lights, two retractable landing lights, a taxi light, two anti-collision lights, two optional wing deice lights, two optional wing tip recognition lights and two optional oscillating beacon ground recognition lights. Refer to Section 8 for specific light bulb information.

All exterior lighting should be checked for proper operation before night flying. Cockpit recognition of operational exterior lighting can be determined by looking for ground illumination or reflections on the ground by the various lights.

Navigation Lights

The navigation lights are located in the tailcone stinger and in each wing tip assembly. These lights are energized with the navigation lights switch breaker on the side console, refer to Figure 7-24. Proper operation can be checked by observing illumination on objects surrounding the wing tips to ensure the lights are illuminated.

Landing Lights

The retractable landing lights are located in the lower surface of the wing tips. These lights are extended, retracted and illuminated by the landing light switch breaker on the side console, refer to Figure 7-24. With the switch positioned to LGT LT EXT, the landing lights will extend and illuminate. In the OFF (center) position, the lights will remain extended but will not illuminate. In the RETRACT position, the lights will retract flush with the respective wing tip. It is recommended that the landing light extension speed be limited to 180 KIAS to improve the landing light service life.

Taxi Light

The taxi light, attached to the nose gear, provides adequate illumination for night taxiing. The taxi light is controlled by the taxi light switch breaker on the side console, refer to Figure 7-24.

Anti-Collision Lights

The anti-collision lights, with individual power supplies, are located in the wing tips. These lights are actuated by the anti-collision light switch breaker on the side console, refer to Figure 7-24.

NOTE

Do not operate the anti-collision lights in conditions of fog, clouds or haze as the reflection of the light beam can cause disorientation or vertigo.

Wing Deice Lights

The optional wing deice lights are installed in the outboard side of each engine nacelle and illuminate the outboard wing leading edge deice boots. The lights allow the pilot to check for ice accumulation on the wing leading edges. The lights are actuated by the deice light switch breaker on the side console, refer to Figure 7-24.

Wing Tip Recognition Lights

The optional wing tip recognition lights, if installed, are located in the outboard leading edge of the wing tip. These lights are controlled by the recognition light switch breaker on the left side console, refer to Figure 7-24.

Oscillating Beacon Ground Recognition Lights

The optional oscillating beacon ground recognition lights, if installed, are located in the vertical fin and lower fuselage. These lights are controlled by the oscillating beacon light switch breaker on the left side console, refer to Figure 7-24. These beacon lights are not approved as anti-collision lights.

INTERNAL LIGHTING

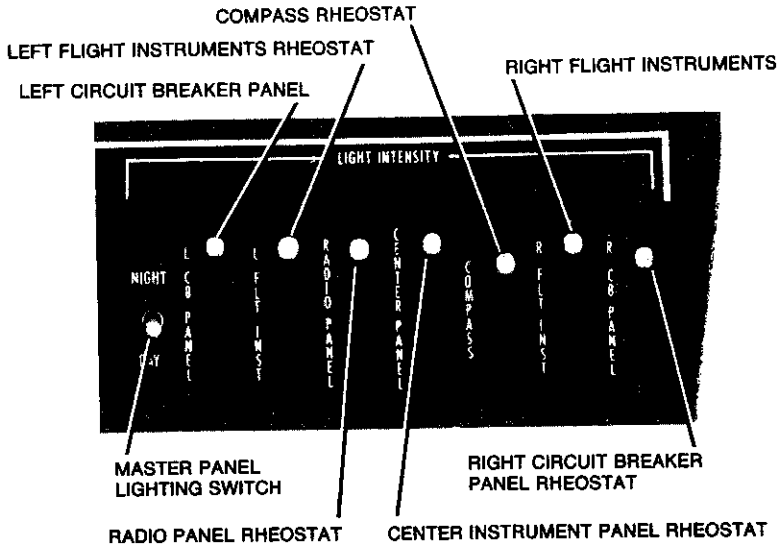
The airplane is equipped with lighting for baggage areas, cabin doorway, cockpit controls and indicators, cockpit illumination and cabin illumination. Refer to Section 8 for specific light bulb information.

Baggage area lights are provided for the nose baggage and both wing lockers area. The lights are actuated when the applicable baggage door is opened and extinguish when the door is closed.

The cabin doorway and instrument panel floodlight provides adequate illumination for night boarding. These lights are controlled by a switch immediately inside the cabin doorway, refer to Figure 7-26, or by a switch on the instrument panel, refer to Figure 7-7. An optional timer is available which will automatically extinguish the cabin doorway and instrument panel floodlights 15 minutes after leaving the airplane if the lights were not switched off. The system operation is as follows:

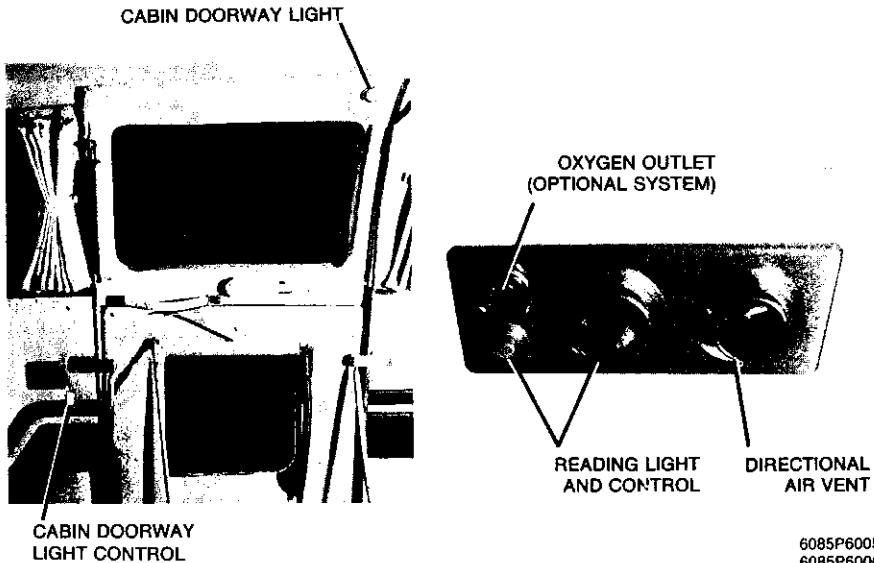
1. The cabin doorway and instrument panel floodlights can be actuated by either of the two switches described above. Any time the lights come on, the timer begins to count down for 15 minutes.
2. With the cabin door closed, the lights will operate in a normal fashion (i.e., lights out, movement of either switch turns lights on; lights on, movement of either switch turns lights off), unless the timer has extinguished the lights, thus requiring cycling of either switch to turn the lights on again.
3. Opening the door will turn the lights on unless the timer extinguished the lights, in which case, one movement of the door switch is also required in order to turn the lights on.
4. With the cabin door open, the lights will always be on unless the timer has turned them off. Movement of the door switch is required to reset the lights to on for an additional 15 minutes.
5. Closing the door will extinguish the lights only if the system is switched off. If the system is on, the timer must continue to run down to extinguish the lights.

Cockpit lighting is provided by the instrument panel floodlight, instrument postlights and overhead map lights. All cockpit lights are variable intensity and are controlled by rheostats on the left side circuit breaker panel, refer to Figure 7-25.



5914P6012

Figure 7-25
COCKPIT LIGHTING AND CONTROLS



6085P6005
6085P6006

Figure 7-26
CABIN LIGHTING AND CONTROLS

NOTE

● *All red warning lights on the annunciator panel illuminate at maximum intensity regardless of the position of the master lighting switch.*

● *The master lighting switch must be positioned to DAY during daylight operations to ensure maximum illumination of the annunciator panel lights.*

Individual reading lights and controls, refer to Figure 7-26, are provided in the cabin for each passenger seat.

BLEED AIR SYSTEM

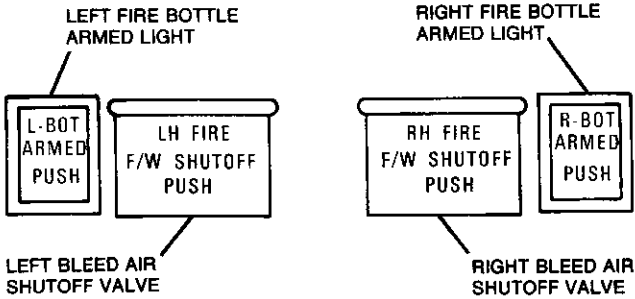
The bleed air system, refer to Figure 7-28, provides engine compressed air to the airplane for cabin heating. The air flows through an insulated bleed air line from the engine to the firewall and then through a shrouded bleed air line, a dual purpose flow control, pressure and shutoff valve, another insulated bleed air line, source control valve and through a check valve into the cabin air distribution system. A connection tees off of the flow control valve to supply the auxiliary pneumatic systems which include instrument air and deice boots, refer to Figure 7-33.

NOTE

Refer to Flight Instruments description in this section for information concerning bleed air system overpressure.

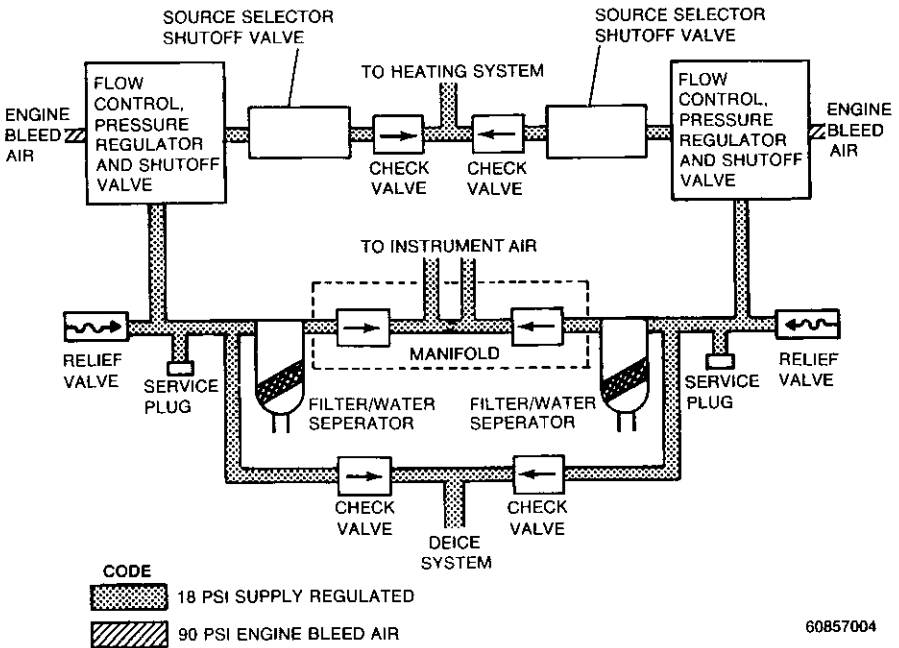
The bleed air shutoff feature, refer to Figure 7-27, of the regulated pressure flow control valve is used for emergency procedures in the event of bleed air contamination or bleed air line failure in the wing leading edge. All bleed air and fuel from the respective engine may be shut off by pressing the appropriate firewall shut off button. In addition to shutting off bleed air and fuel, pressing the button will also arm the optional engine compartment fire bottle and take the generator off line illuminating the respective GEN OFF annunciator light. Pressing the fire warning light a second time will disarm the optional fire extinguisher, reconnect the generator and open the bleed air firewall and fuel shutoff valves.

Bleed air can be furnished to all bleed air systems when either or both engines are operating.



60186001

Figure 7-27
BLEED AIR SHUTOFF VALVE



60857004

Figure 7-28
BLEED AIR SYSTEM SCHEMATIC

HEATING, VENTILATING AND DEFROSTING SYSTEMS

CABIN AIR SYSTEM

The cabin air system, refer to Figure 7-29, provides for cabin heating, ventilating and defrosting. Hot bleed air is routed from each engine through the flow control shutoff and pressure control valves. The bleed air is mixed with cabin air to obtain desired cabin temperature. The amount of bleed air permitted into the cabin is controlled by the temperature control valve. Two outlets are located at the base of the windshield for defrosting purposes. Passenger compartment heat is provided by two plenums with nonadjustable heat outlets, located on the left and right side of the cabin just above the floor, and by a nonadjustable heat outlet in the aft section of the cabin near the floor. Two additional heat outlets are located on the forward bulkhead for cockpit heating, refer to Figure 7-29.

Cabin heating and ventilating is accomplished by the cabin air DEFROST, COCKPIT, CABIN AND RAM AIR controls, refer to Figure 7-29. The overhead directional vents also supply unheated ventilating air.

HEATING AND DEFROSTING

During heating and/or defrosting operation, cabin recirculated air is mixed with bleed air and distributed to the pilot and passenger compartments. An aft cabin compartment air outlet is provided to exhaust cabin air.

On the ground, the heating system can be used for ventilation by placing the FRESH AIR blower switch, located on instrument panel, refer to Figure 7-29, to HIGH or LOW. The fan provides fresh outside air from the nose wheelwell to the cabin through the cabin heat outlets. In flight the FRESH AIR switch shall be positioned to OFF.

CABIN HEAT CONTROLS

The cabin temperature is controlled by three controls located on the instrument panel, refer to Figure 7-29. The controls are labeled CABIN HEAT AUTO, MANUAL AND SOURCE SELECT.

The cabin heat auto knob, which is connected to the temperature controller, controls the amount of bleed air entering the cabin to maintain a desired selected temperature.

The manual heat toggle switch, center return, is electrically connected to the temperature control valve. If auto control is on MANUAL when the toggle is held in the WARMER position the temperature control valve will open allowing additional bleed air to enter the heating system. When positioned to COOLER the valve will close. The control valve will

close. The control valve will stop in any position when the toggle switch is released. The total time for valve operation from full close to full open is approximately 13 seconds. The manual heat toggle switch will not function unless cabin heat auto knob is positioned to manual.

The cabin heat source select knob controls the source of bleed air used for heating.

CABIN AIR CONTROLS

Windshield defrosting and defogging is controlled by the push-pull defrost knob. When the knob is pulled out, air flows from the defroster outlets at the base of the windshield. The knob may be set in any intermediate position to regulate the defroster airflow.

Cockpit/cabin air control directs airflow to the cockpit and cabin. When knob is pulled out, air flows to the cockpit air outlets. When knob is pushed in, air flows to passenger compartments air outlets. The knob may be set in any intermediate position to regulate the quantity of air to the cabin and cockpit.

The ram air knob control directs outside air to cockpit and heating system. When knob is pulled outside unheated air is directed to the cockpit for fresh air or smoke removal. When knob is pushed, outside unheated air is directed to the heating system. The knob may be set in any intermediate position to regulate the air flow.

AIR DUCT OVERHEAT SWITCH

A red overheat warning light in the annunciator panel is labeled AIR DUCT O'HEAT, refer to Figure 7-9. When illuminated, the light indicates that the air temperature in the cabin distribution duct is above at 104 degrees Celsius (220 degrees \pm 5 degrees Fahrenheit).

VENTILATING SYSTEM

During ground operation, ventilation is provided by the ventilating fan of the cabin heat system or the optional circulation blower, if installed.

In flight ventilation, for airplanes without optional air conditioning installed, is obtained through the ram air inlet located at the forward end of the dorsal fin. This ram air is then distributed to the cabin via the overhead directional air vents. On airplanes with optional air conditioning or optional blower systems, a duct mounted internally in the dorsal fin, activated by cam/microswitch butterfly valves, provide availability of conditioned air or outside ram air depending on cabin comfort requirements.

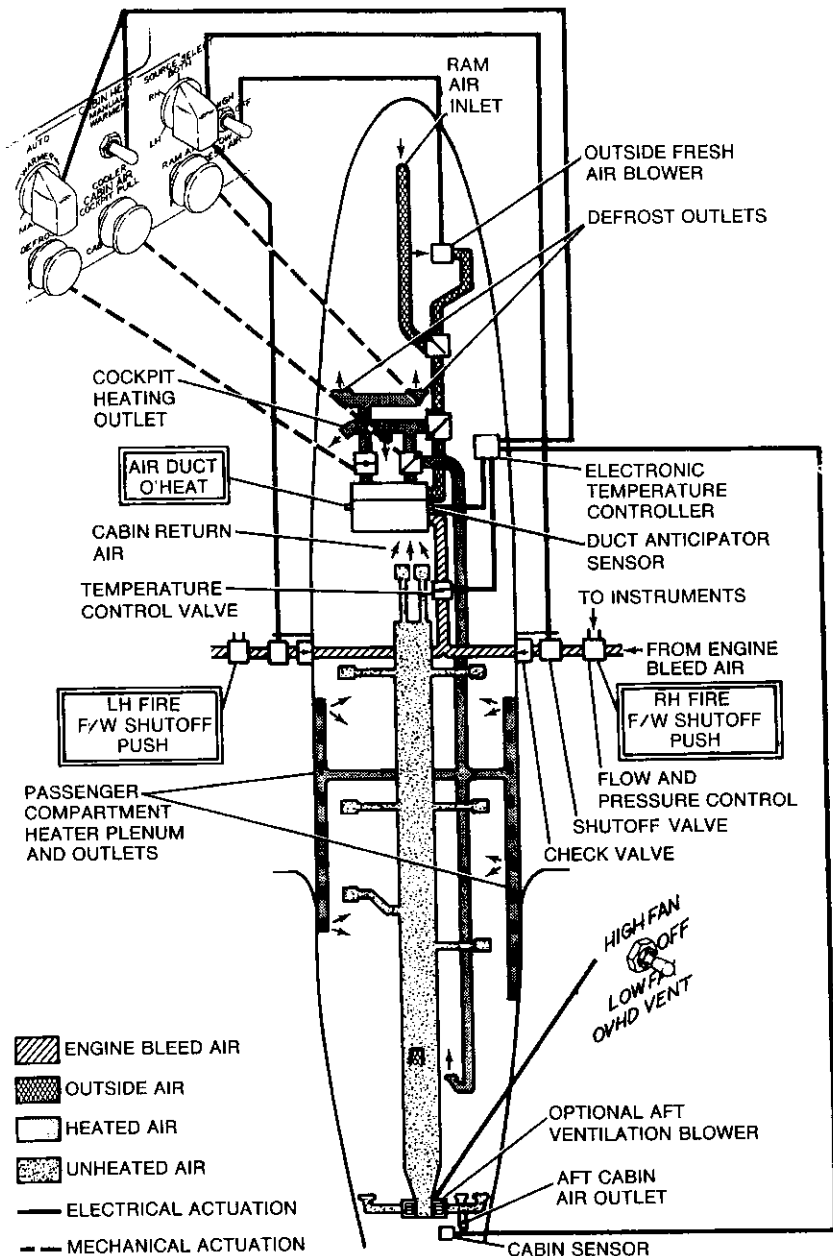


Figure 7-29
CABIN AIR SYSTEM SCHEMATIC

60857010

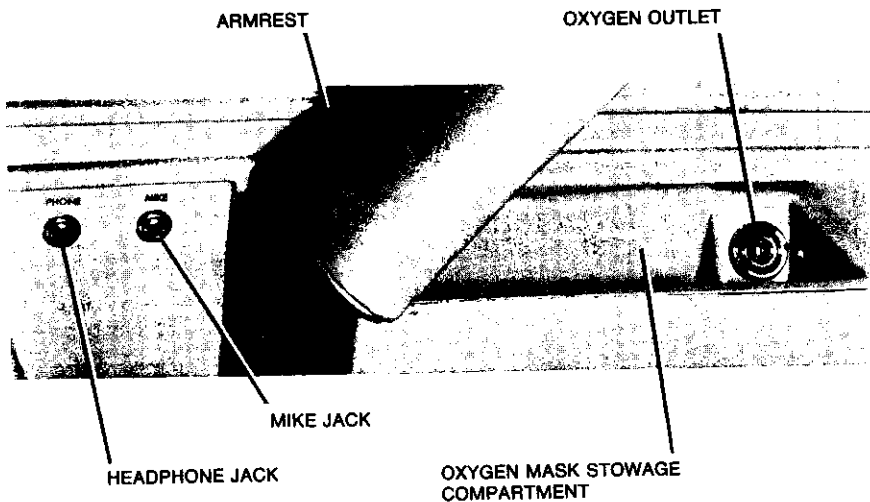
OXYGEN SYSTEM

The optional oxygen system provides individual service for the pilot, copilot and each passenger. The oxygen supply is stored in a 114.9 cubic foot bottle located in the nose compartment. Cabin plumbing, including outlets for each occupant, will vary with individual airplane seating configuration. The oxygen control, and pressure gage are located on the instrument panel (refer to Figure 7-7).

The oxygen system is activated by pulling the oxygen control knob, to the ON position, allowing oxygen to flow from the regulator to all cabin outlets. A normally closed valve in each oxygen outlet is opened by inserting the connector of the mask and hose assembly. After flights using oxygen, the pilot should ensure that the oxygen system has been deactivated by unplugging all masks and pushing the oxygen control knob completely to the OFF position.

NOTE

If the oxygen control knob is left in an intermediate position between ON and OFF, it may allow low pressured oxygen to bleed through the regulator into the nose compartment of the airplane.



PILOT'S SIDE SHOWN: IDENTICAL CONTROLS ARE PROVIDED FOR THE COPILOT.

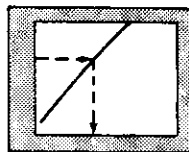
6084P6001

Figure 7-30
COCKPIT OXYGEN OUTLETS

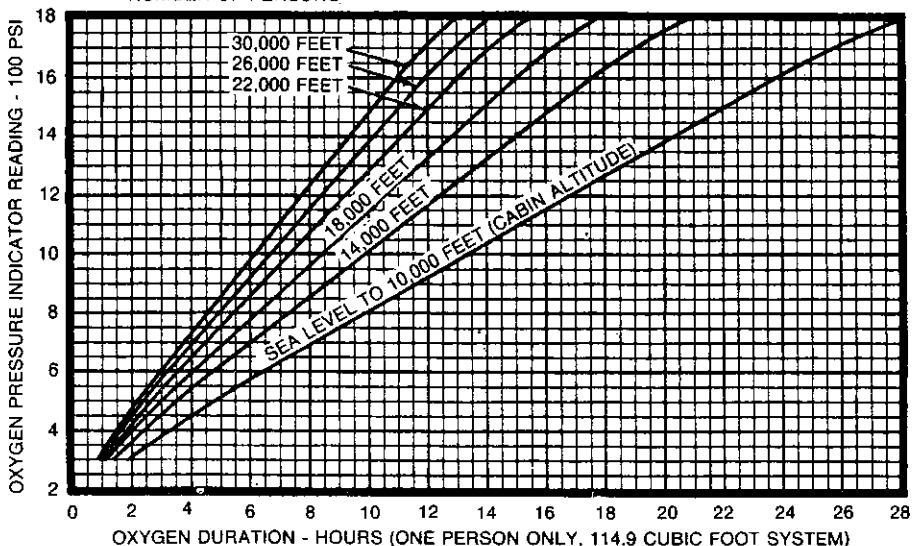
The oxygen system with optional 114.9 cubic foot oxygen bottle provides adequate oxygen flow rates up to 30,000 feet, refer to Figure 7-31. The oxygen outlets for the pilot and copilot are located inside the stowage compartment under the outboard armrests, refer to Figure 7-30. Oxygen outlets for passengers are located overhead of each seat position, refer to Figure 7-26. The pilot, copilot and passengers shall always use the blue hose assemblies.

WARNING

OXYGEN MASKS, WITH BLUE HOSE ASSEMBLIES, FURNISHED WITH THE AIRPLANE ARE THE ONLY OXYGEN MASKS APPROVED FOR USE IN THIS AIRPLANE. NO OTHER OXYGEN MASKS ARE APPROVED FOR USE.



$\frac{\text{OXYGEN DURATION IN HOURS}}{\text{NUMBER OF PERSONS}} = \text{TOTAL HOURS DURATION}$



58847013

**Figure 7-31
OXYGEN DURATION CHART**

PITOT/STATIC PRESSURE SYSTEM

The pitot/static pressure system, refer to Figure 7-32, consists of two totally separate systems; one for the pilot's instruments and the second system for copilot's instruments.

PILOT'S SYSTEM

The pilot's pitot system consists of a heated pitot tube mounted on the lower left side of the fuselage nose, pilot's airspeed indicator and required plumbing.

The pilot's static system consists of a static source located on each side of the aft fuselage, a condensate drain valve located below the copilot's instrument panel on the side wall and the static system instruments (rate-of-climb, altimeter and airspeed indicators).

Pitot and static heat is controlled by the L PITOT/STATIC switch located on the left side console. Actuation of the switch electrically heats the pitot head and heated static sources to maintain system operation during icing conditions. Do not operate for prolonged periods while on the ground to prevent overheating the pitot head heating elements. The copilot's instruments are used as a back-up system, should the pilot's instruments fail.

COPILOT'S SYSTEM

The copilot's pitot system consists of a heated pitot tube mounted on the lower right side of the fuselage nose, copilot's airspeed indicator and required plumbing.

The copilot's static system consists of a static source located on each side of the aft fuselage, a condensate drain valve located below the copilot's instrument panel adjacent to the pilot's system drain valve, and the static system instruments (rate-of-climb, altimeter and airspeed indicators).

Pitot and static heat is controlled by the R and L PITOT/STATIC switches located on the left side console. Actuation of the switch electrically heats the pitot head and heated static sources to maintain system operation during icing conditions. Do not operate for prolonged periods while on the ground to prevent overheating the pitot head heating elements.

PNEUMATIC SYSTEM

The pneumatic system, refer to Figures 7-28 and 7-33, utilizes a source of bleed air pressure for the gyro instruments and the optional

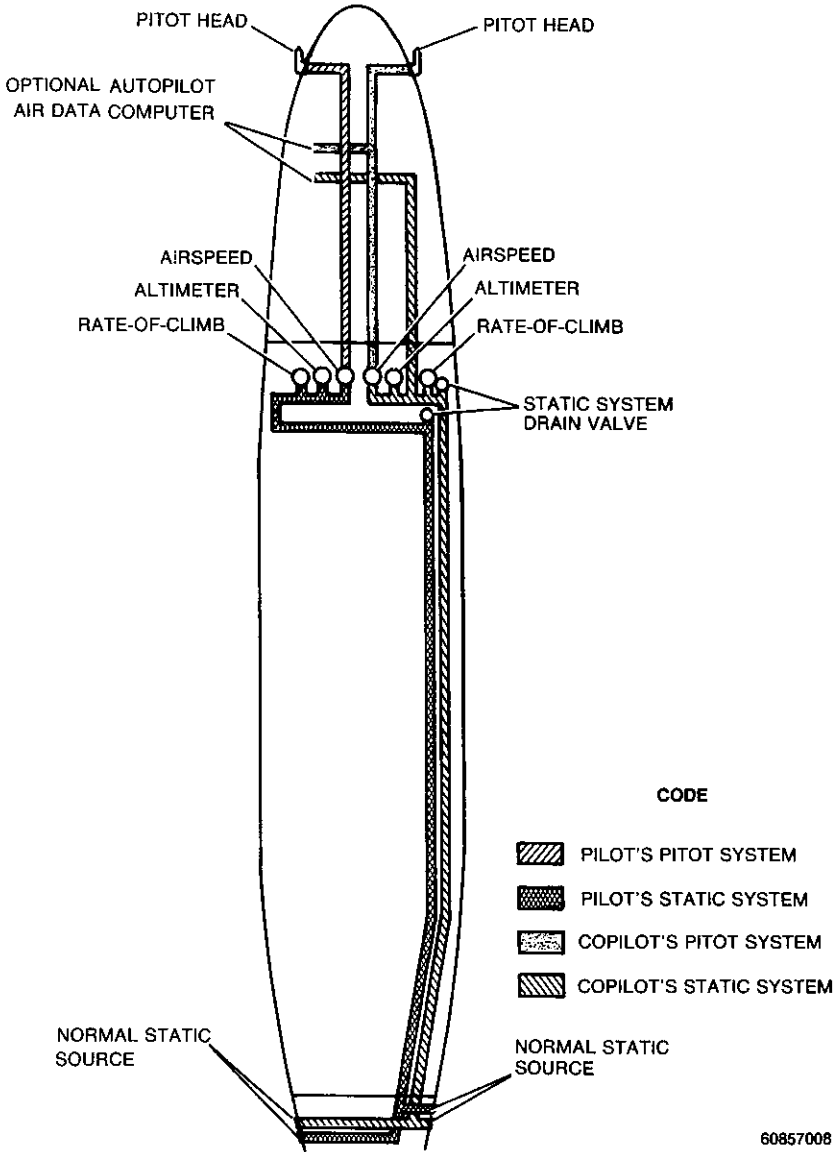


Figure 7-32
PITOT/STATIC PRESSURE SYSTEM

deice boots. The system consists of water separator(s) and filter(s), pressure regulator(s), pressure indicator(s), gyro instruments and plumbing.

Bleed air flows from each engine through firewall shutoff flow and pressure control valves and through check valves to the water separator(s) and air filter(s) and then through pressure regulator(s) where the air pressure is reduced to approximately 2.5 pounds per square inch. The air then flows separately through the R and L gyro instruments and is routed overboard. The pressure being applied to the gyros is constantly presented on the pressure indicator.

The pressure indicators monitor the air delivered to the instruments by the pressure regulators. Two source indicator buttons located in the pressure indicators alert the pilot to an inactive source. Failure of either source would otherwise be undetected since the manifold allows the remaining source to supply both banks of instruments and both indicators.

NOTE

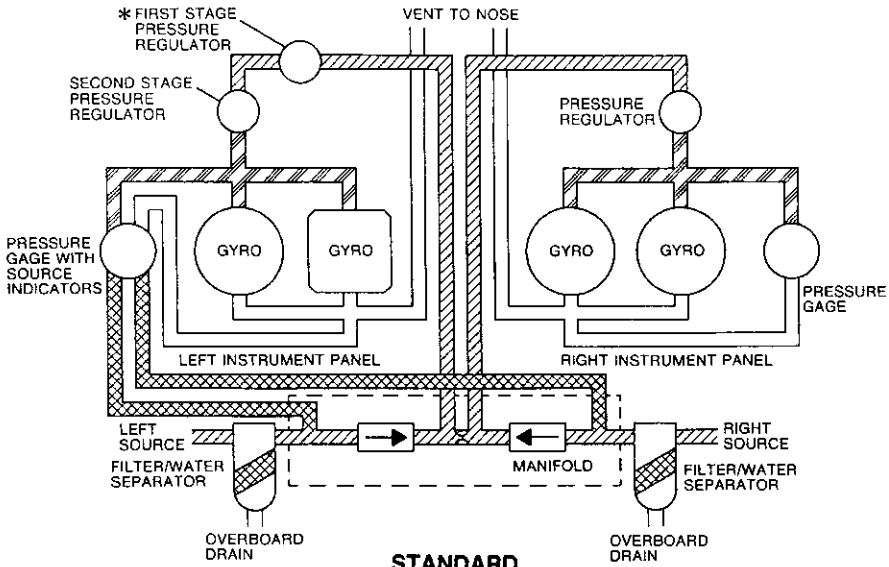
● *For operation with one bleed air shutoff valve closed or one engine inoperative, power above FLIGHT IDLE may be required on the operating engine to maintain gyro pressure in the green arc.*

● *Refer to Flight Instruments description in this section for information concerning bleed air system overpressure.*

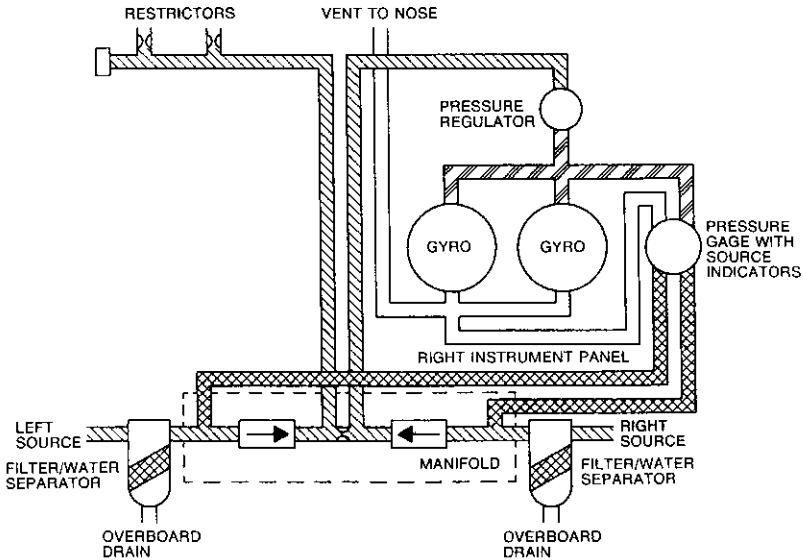
STALL WARNING SYSTEM

A stall warning system is required equipment which consists of a stall warning transmitter vane located in the left wing tip leading edge; a switch located behind the instrument panel activated by the elevator control linkage; a switch located below the floorboard actuated by the wing flap bellcrank; a cockpit warning horn and the necessary wiring to complete the system.

The stall warning horn will sound approximately 5 to 10 Knots above the stall. The horn will also sound when the elevator is in the full nose up position and the wing flaps are in the LAND position. The first stall warning horn check can be accomplished by activating the PRESS-TO-TEST button, located on the annunciator panel, Refer to Figure 7-9. The second part of the stall warning system is checked by positioning the elevator in the full nose up position and extending the wing flaps to LAND position. In this configuration the stall warning horn will also sound. The stall warning vane heater should be checked by actuating the stall vane heat switch and cautiously feeling the vane for heat.







STANDARD



PILOT ELECTRIC HORIZONTAL AND DIRECTIONAL GYROS

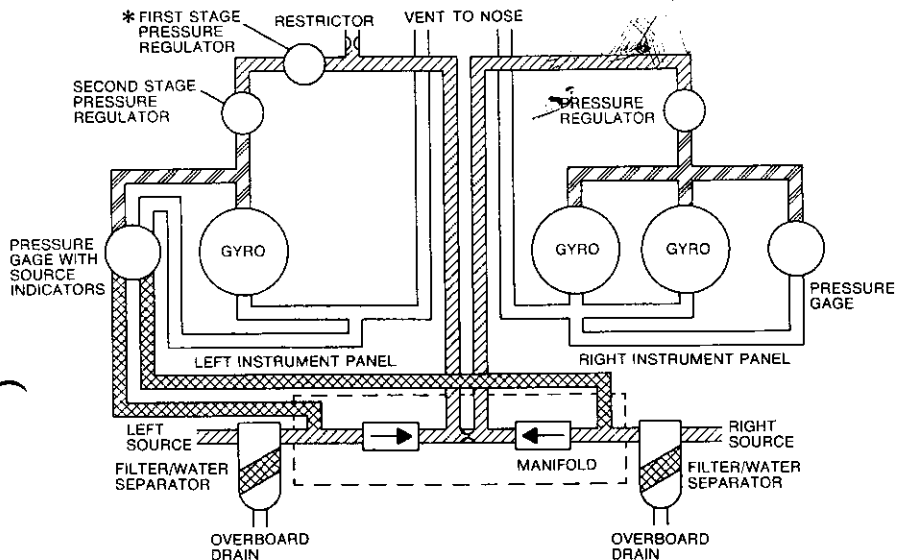
CODE

-  18 PSI SUPPLY REGULATED CODE
-  18 PSI STATIC TO SOURCE INDICATOR
-  VENTED TO AMBIENT
-  2.5 PSI REGULATED

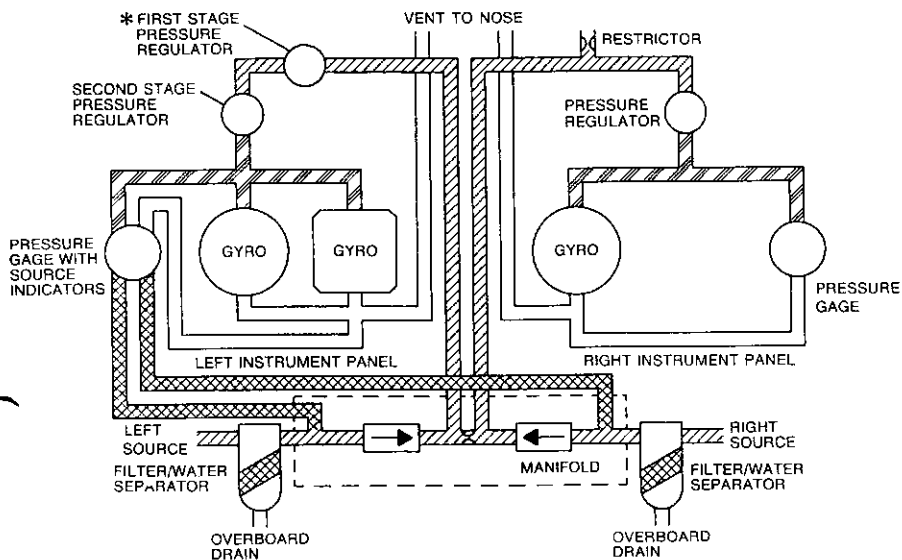
* AIRPLANES -0020 AND ON
AND AIRPLANES -0001 THRU
-0019 INCORPORATING
SK425-41

60857011

Figure 7-33 (Sheet 1 of 3)
INSTRUMENT AIR SYSTEM SCHEMATIC







PILOT ELECTRIC DIRECTIONAL GYRO



COPILOT ELECTRIC DIRECTIONAL GYRO

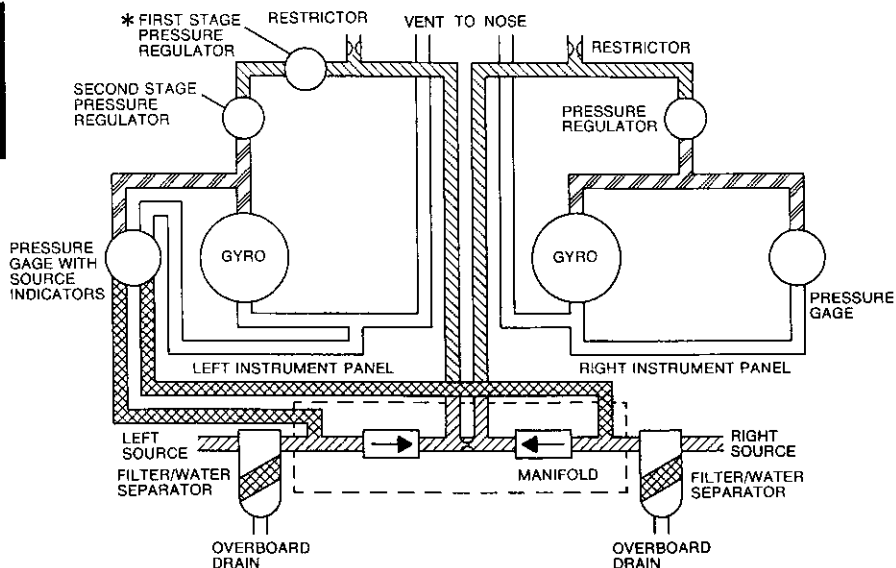
CODE

-  18 PSI SUPPLY REGULATED CODE
-  18 PSI STATIC TO SOURCE INDICATOR
-  VENTED TO AMBIENT
-  2.5 PSI REGULATED

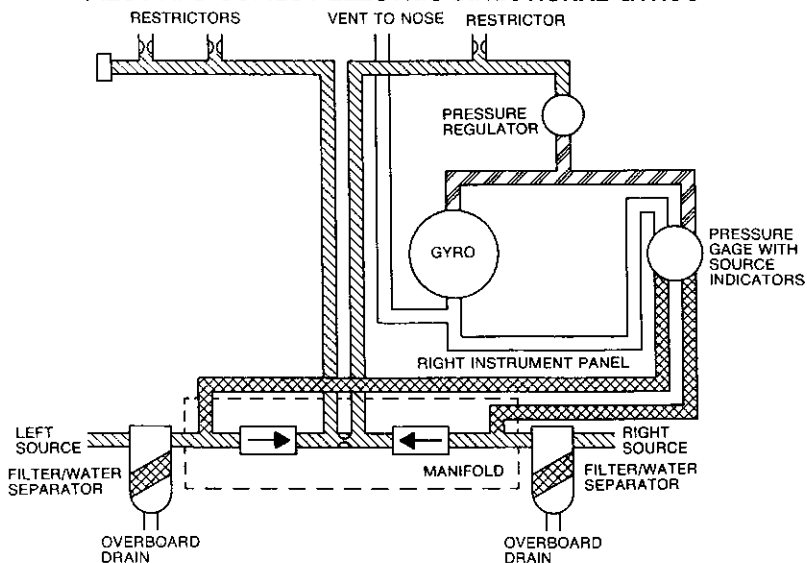
* AIRPLANES -0020 AND ON
AND AIRPLANES -0001 THRU
-0019 INCORPORATING
SK425-41

60857005

**Figure 7-33 (Sheet 2 of 3)
INSTRUMENT AIR SYSTEM SCHEMATIC**







PILOT AND COPILOT ELECTRIC DIRECTIONAL GYROS



**PILOT ELECTRIC HORIZONTAL AND DIRECTIONAL GYROS AND
COPILOT ELECTRIC DIRECTIONAL GYRO**

CODE

-  18 PSI SUPPLY REGULATED CODE
-  18 PSI STATIC TO SOURCE INDICATOR
-  VENTED TO AMBIENT
-  2.5 PSI REGULATED

* AIRPLANES -0020 AND ON
AND AIRPLANES -0001 THRU
-0019 INCORPORATING
SK425-41

60857012

**Figure 7-33 (Sheet 3 of 3)
INSTRUMENT AIR SYSTEM SCHEMATIC**

ICING EQUIPMENT

With the proper standard and optional equipment installed and operational, this airplane is approved for flight into icing conditions as defined by the FAA, refer to Section 2, Kinds of Operation Limits and Section 9, Flight In Icing Conditions.

PROPELLER DEICE SYSTEM

The propeller deice system consists of electrically heated boots on the propeller blades. Each boot consists of an inboard and outboard heating element which receives its electrical power through a deice timer. To reduce power drain, the timer directs current to the propeller boots in cycles between elements in the following sequence:

Heating Period No. 1 - Outboard Halves

Heating Period No. 2 - Inboard Halves

Each heating period lasts approximately 20 seconds.

A reading below the green arc on either the left or right propeller deice ammeter indicates that the blades of the propeller are not being deiced uniformly.

| |
|----------------|
| WARNING |
|----------------|

WHEN UNEVEN DEICING OF THE PROPELLER BLADES ON EITHER ENGINE IS INDICATED, IT IS IMPERATIVE THAT THE ASSOCIATED PROPELLER DEICE SYSTEM SWITCH BREAKER BE TURNED OFF. UNEVEN DEICING OF THE BLADES WILL RESULT IN PROPELLER UNBALANCE AND CAN LEAD TO ENGINE FAILURE.

Abnormal operation of the propeller deice system is indicated by engine/propeller roughness or by tripping of the L and/or R PROPELLER switch breakers. Failure of the L or R PROPELLER circuit breaker to stay reset indicates failure of the applicable propeller deice system.

AVIONICS

Information concerning avionics equipment is contained in the applicable supplements in Section 9.

AVIONICS INTERFERENCE

NOTE

When turned to a weak NAV signal, keying the COM transmitter may cause momentary interference within the NAV receiver causing a NAV flag to appear. Should circumstances warrant, ATC should be requested to assign another COM frequency.

AVIONICS MASTER SWITCHES

Two avionics bus switches, refer to Figure 7-24, are provided on the left side console. Basically, the L AVIONICS BUS switch controls power to the No. 1 avionic circuit breakers while the R AVIONICS BUS switch controls power to the No. 2 avionics circuit breakers and the autopilot. Complete information is presented in the Avionics Bus Failure procedure in Section 3.

1000 AUDIO CONTROL PANEL (TYPE F-1010B)

The 1000 audio control panel provides for amplification of the audio signals for the speaker system and allows audio switching for the cockpit and cabin speakers, headsets, intercom and microphones. The audio panel may be installed in a single configuration, where pilot and copilot utilize the same panel, or in dual configuration, which has one panel for each position.

NOTE

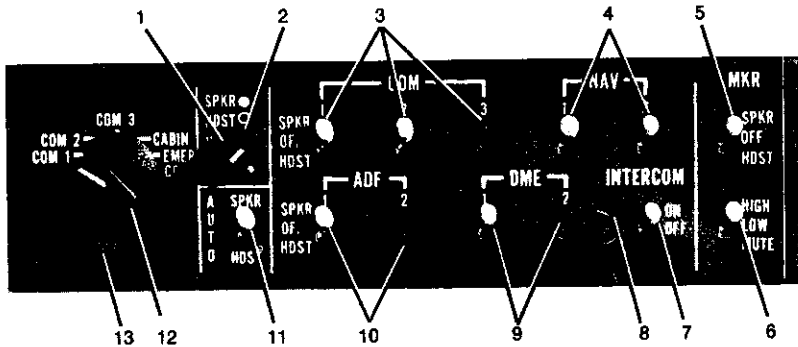
In a dual configuration it is recommended that headsets be used, by the pilot and copilot, instead of speakers to avoid possible audio feedback. If pilot and copilot are tuned to different frequencies, they will not hear each others sidetone on headsets.

All operating controls and indicators are located on the front of the panel, refer to Figure 7-34. The receiver selector switches that are used on the audio control panel are determined by the avionics equipment installed in the airplane. Unused switches are identified with a black boot on the switch handle.

Power to the audio control panel(s) is arranged so that, in either a single or dual installation, access to a usable communication receiver/transmitter is maintained. In a single audio control panel installation, COM 1 is delivered as the designated emergency receiver/transmitter and in the event of a failure of the control panel, communications can be maintained through COM 1 by selecting EMER COM position. In a dual

audio control panel installation, COM 1 is the designated emergency receiver/ transmitter for the pilot and COM 2 is the designated emergency receiver/ transmitter for the copilot. When EMER COM is selected, headsets must be used since power is removed from the audio amplifier, disabling the speaker amplifier.

In the event of a left bus failure or shutdown in which COM 1 is disabled, the single control panel, or in a dual installation, the pilots control panel will remain completely operative since it derives its primary power from the right bus. Access to COM 2 may be selected in the normal manner. The converse is true for the copilots panel which is supplied power from the left bus enabling it to function normally in the event of a failure or shutdown of the right bus in which case COM 2 is also disabled. COM 1 is still available for normal usage by selecting COM 1 on the copilot's panel or selecting EMER COM on the pilots panel. Although power distribution is cross-bussed to allow more flexibility, the circuit breakers are appropriately labeled as to which panel they control.



5914P6014

1. VOL HDST CONTROL - Controls volume level for headset audio.
2. VOL SPKR CONTROL - Controls volume level for cockpit speaker.
3. COM 1, 2, 3 SPKR/OFF/HDST RECEIVER SELECTOR SWITCHES - Selects COM receiver audio from COM 1, COM 2 or COM 3 receivers for either speaker or headset. OFF position turns off COM audio.

**Figure 7-34 (Sheet 1 of 4)
1000 AUDIO CONTROL PANEL (TYPE F-1010B)**

NOTE

● *Although all the COM 1, 2, 3 SPKR/OFF/HDST switches select the individual receiver audio for monitoring, the function selector switch automatically selects the appropriate COM receiver audio for monitoring on either speaker or headset as selected by the AUTO SPKR/HDST switch.*

● *In a single installation, the audio signals from the COM, NAV, ADF, DME and marker beacon receivers will be muted whenever any microphone key is actuated for COM 1, COM 2 or COM 3 operation. In dual installations, the pilot's microphone can be actuated without muting the audio being monitored by the copilot. The reverse is also true.*

4. NAV 1, 2 SPKR/OFF/HDST
RECEIVER SELECTOR
SWITCHES - Selects Nav receiver audio from Nav 1 or Nav 2 receivers for either speaker or headset. OFF position turns off Nav audio.
5. MKR SPKR/OFF/HDST
RECEIVER SELECTOR
SWITCHES - Selects marker beacon receiver audio for either speaker or headset. Off position turns off marker beacon audio.
6. HIGH/LOW/MUTE
SELECTOR/SWITCH - Selects marker beacon receiver sensitivity, HIGH or LOW. MUTE is a momentary contact switch position that cuts off the marker beacon audio for approximately 30 seconds. When MUTE position is released, switch returns to LOW.

NOTE

In dual installation, the HIGH/LOW sensitivity is not selectable from the copilot's audio control panel.

**Figure 7-34 (Sheet 2 of 4)
1000 AUDIO CONTROL PANEL (TYPE F-1010B)**

7. INTERCOM ON/OFF
SELECTOR SWITCH - Turns on pilot and copilot microphones for intercommunication with each other. In dual installations, setting either of the INTERCOM selector switches to ON provides intercommunication.

NOTE

Audio feedback may be encountered if AUTO/SPKR is selected during INTERCOM operation.

8. SIDETONE SCREWDRIVER
ADJUST - Adjusts sidetone level in speaker. Sidetone is obtained when transmitting on Com 1, Com 2 or Com 3.

NOTE

Sidetone adjustment is normally a maintenance function and not part of the normal operating procedure.

9. DME 1, 2, SPKR/OFF/HDST
RECEIVER SELECTOR
SWITCHES - Selects DME receiver audio from DME 1 or DME 2 receivers for either speaker or headset, OFF position turns off DME audio.
10. ADF 1, 2, SPKR/OFF/HDST
RECEIVER SELECTOR
SWITCHES - Selects ADF receiver audio from ADF 1 or ADF 2 receivers for either speaker or headset. OFF position turns off ADF audio.
11. AUTO SPKR/HDST
SELECTOR SWITCH - Selects either speaker or headset for the associated audio selected via the function selector switch.

**Figure 7-34 (Sheet 3 of 4)
1000 AUDIO CONTROL PANEL (TYPE F-1010B)**

12. CABIN CALL - Back-lighted green indicator that lights when the cabin microphone switch is actuated to signal the cockpit that the cabin wishes to communicate via the cabin microphone and speaker. Cockpit communication with the cabin is made by setting the Function Selector Switch to the CABIN position. The incoming audio selected via the receiver selector switches will not be interrupted when the Function Selector Switch is set to CABIN position.

NOTE

With dual audio control panels, pilot communication with the cabin will be the same as previously described. However, both pilot's and copilot's selector switches must be in the CABIN position for the copilot to communicate with the cabin.

13. COM 1/COM 2/COM 3/CABIN/EMER
COM FUNCTION
SELECTOR SWITCH - Selects the microphone connection for Com 1, Com 2 or Com 3 transmission, cabin communication or the emergency mode of operation. In COM 1, COM 2, COM 3 and CABIN switch positions, the associated audio is automatically selected for monitoring on either headset or speaker, as selected by the AUTO SPKR/HDST switch.

**Figure 7-34 (Sheet 4 of 4)
1000 AUDIO CONTROL PANEL (TYPE F-1010B)**

LOCATOR BEACON (MODEL DMELT-6 AND -6C)

The locator beacon system is a battery-operated, sweep tone emergency radio transmitter incorporating an externally mounted whip antenna and a transmitter with an integral 3-position switch, all located on the left side of the fuselage tailcone. The switch can be reached by removing the plug button located adjacent to the locator beacon placard. Normally, the switch is in the ARM (AUTOMATIC "G" OPERATION) position; this position allows the transmitter to be activated automatically by the "G" switch. The ON (EMERGENCY & TEST) position should be used only to test the equipment or whenever a rescue is desired. The OFF (AFTER RESCUE) position should be used only after the rescue as this position will disable all emergency transmissions.

The locator beacon transmits on both 243.0 MHz (UHF) and 121.5 MHz (VHF) emergency frequencies simultaneously. The DMELT-6C locator beacon, provided for operation in Canada, transmits only on the VHF emergency frequency.

Transmitter power is provided by an alkaline battery pack inside the transmitter case.

NOTE

The battery pack must be changed no later than the date specified on the outside of the locator beacon case and on each battery case.

400 MARKER BEACON (TYPE R-402B)

The 400 Marker Beacon consists of a 75 MHz marker beacon receiver, antenna and three instrument panel mounted lights, refer to Figure 7-36. Marker beacon audio is controlled by a speaker phone switch on the audio control panel. Volume level of the marker beacon audio is fixed on initial installation but can be ground adjusted by avionic technicians.

NOTE

●The marker beacon and DME audio level is adjustable only through the master volume control, therefore, it is important to keep the master controls within their normal operating range of approximately 2 o'clock \pm any individual comfort adjustment to take care of ambient voice level or variations in headset types (muff, single receiver, etc.).

●Do not operate the master volume controls at an extremely low setting while turning up the individual receiver volume controls to an extremely high setting. This could result in distortion of NAV, COM and ADF audio as well as low levels of MKR and DME audio.

Sensitivity of the marker beacon is controlled by a HI LOW switch on the audio control panel. Illumination capability of the marker beacon lights can be checked by actuation of the marker beacon test switch. When this switch is actuated, all three marker beacon lights should illuminate.

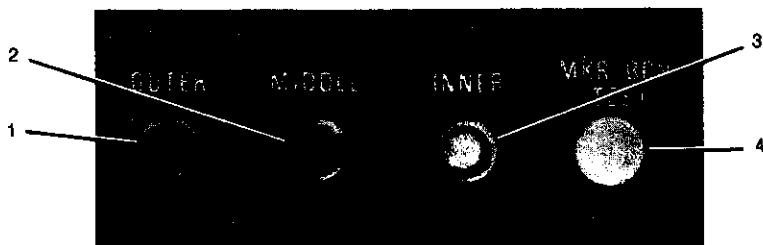
A marker beacon audio mute capability is available to greatly reduce the marker beacon audio level. The audio mute is controlled by a switch on the 1000 audio control panel. Momentary actuation of the audio mute switch will greatly suppress marker beacon audio for approximately 30 seconds.

The marker beacon provides visual and aural indications of the 75 MHz ILS marker beacon signals as each marker is passed. The three most currently used marker facilities and their characteristics are listed in Figure 7-35.

| MARKER | IDENTIFYING TONE | LIGHT* |
|--------|-------------------------------------|--------|
| INNER | CONTINUOUS 6 DOTS PER SEC (3000 HZ) | WHITE |
| MIDDLE | ALTERNATE DOTS AND DASHES (1300 HZ) | AMBER |
| OUTER | 2 DASHES PER SEC (400 HZ) | BLUE |

*WHEN THE IDENTIFYING TONE IS RECEIVED, THE RESPECTIVE INDICATING LIGHT WILL BLINK ACCORDINGLY.

Figure 7-35
MARKER FACILITIES



5914P6047

1. OUTER MARKER BEACON
INDICATOR LIGHT - Indicates passage of outer marker beacon.
The OUTER light is blue.
2. MIDDLE MARKER BEACON
INDICATOR LIGHT - Indicates passage of middle marker beacon.
The MIDDLE light is amber.
3. INNER MARKER BEACON
INDICATOR LIGHT - Indicates passage of inner marker beacon.
The INNER light is white.
4. MARKER BEACON TEST SWITCH - Switch actuation illuminates the three marker beacon lights.

Figure 7-36
400 MARKER BEACON INDICATOR LIGHTS

400 GLIDESLOPE (TYPE R-843A)

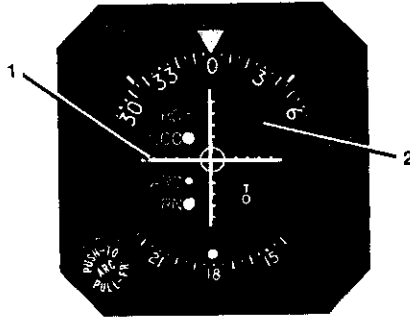
The glideslope receiver is an airborne navigation equipment which receives and interprets glideslope signals from a ground-based instrument landing system (ILS). It is used with the localizer function of a VHF navigation receiver for making precision instrument approaches to an airport. The glideslope provides vertical flight path guidance while the localizer provides azimuth guidance.

Operation of the glideslope receiver is controlled by the associated VHF navigation receiver. When the VHF navigation frequency selector switches are set to a localizer frequency, the glideslope receiver is energized and the paired glideslope frequency is automatically selected. Flight guidance is displayed on the glideslope indicator, refer to Figure 7-37, or horizontal situation indicator (HSI).



●WHEN GLIDESLOPE "OFF" OR "GS" IS VISIBLE, GLIDESLOPE INDICATIONS ARE UNUSABLE.

●SPURIOUS GLIDESLOPE SIGNALS MAY EXIST IN THE AREA OF THE LOCALIZER BACK COURSE APPROACH WHICH CAN CAUSE THE GLIDESLOPE "GS" FLAG TO DISAPPEAR AND PRESENT UNRELIABLE GLIDESLOPE INFORMATION. DISREGARD ALL GLIDESLOPE SIGNAL INDICATIONS WHEN MAKING A LOCALIZER BACK COURSE APPROACH UNLESS A GLIDESLOPE (ILS BC) IS SPECIFIED ON THE APPROACH CHART, AUTOPILOT OR OTHER AVIONIC EQUIPMENT.



6085P6014

1. GLIDESLOPE DEVIATION POINTER - Indicates deviation from normal glide path.
2. GLIDESLOPE FLAG - When visible, flag indicates unreliable glideslope signal or improperly operating equipment. The flag disappears when a reliable glideslope signal is being received.

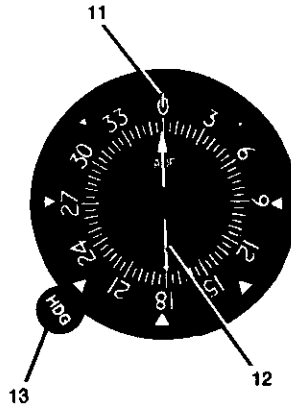
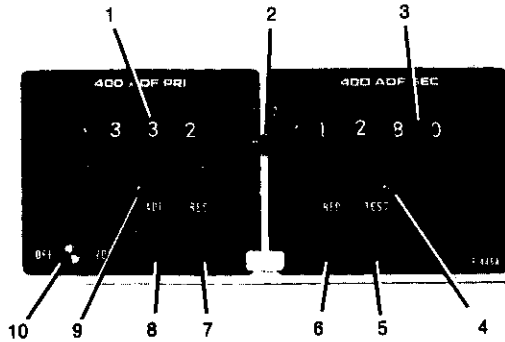
**Figure 7-37
GLIDESLOPE INDICATOR**

400 AUTOMATIC DIRECTION FINDER (TYPE R-446A)

The 400 ADF (Type R-446A) is an automatic direction finder set which provides continuous, visual bearing indications of the direction from which an RF signal is being received. It can be used for plotting position, for homing, and for aural reception of AM signals between 200 kHz and 1699 kHz. In addition, a crystal-controlled, beat frequency oscillator (BFO) permits coded identifier of stations transmitting keyed CW signals (Morse Code) to be heard.

The 400 ADF consists of an R-446A receiver with dual frequency selectors, fixed loop antenna, indicator(s) and a sense antenna. Depending upon the avionics options installed, the indicator(s) can be IN-346A or IN-346B bearing indicators or IN-13A-1, IN-404 or IN-1004A RMI indicators. The receiver and goniometer-indicator are panel-mounted units. The sense and fixed loop antennas are mounted on the external airplane surfaces. Operating controls, refer to Figure 7-38, are mounted on the receiver front panel. The goniometer-indicator presents station bearing in degrees of azimuth. The automatic pointer-stow feature alerts the operator to non-ADF operation slewing the pointer to the 3 o'clock position when the REC mode or BFO is selected. An optional RA-446A, RA-346A or RA-346B receiver accessory may be substituted for the goniometer-indicator to supply the goniometer function for driving a conventional ADF indicator or an RMI.

The frequency range of the 400 ADF is electronically divided into three bands: 200-399 kHz, 400-799 kHz and 800-1699 kHz. Frequency spacing within each band is in 1-kHz, increments. The operating frequency and band are selected by a four-section Minilever switch which displays a digital readout of the frequency selected and supplies a binary code to control the logic circuits within the set. A secondary (standby) operating frequency is selected by another four-section minilever switch. Frequency control of the ADF is switched to the primary or the secondary operating frequency by a toggle switch. The operating modes (ADF and REC) are selected by individual pushbutton switches. Additional pushbutton switches are used to select the BFO and to test signal reliability during ADF operation.



1014P6030
1014P6031

1. PRI (PRIMARY FREQUENCY SELECTOR) - Selects and displays "primary" frequency.
2. 1-2 - The "1" position activated "primary" (PRI) frequency. The "2" position activates "secondary" (SEC) frequency.
3. SEC (SECONDARY FREQUENCY SELECTOR) - Selects and displays "secondary" frequency.
4. SECONDARY PRESELECT LAMP - Lamp will flash only when "secondary" (SEC) frequency selection is outside of operating range of the receiver and 1-2 switch is in the "2" position.

Figure 7-38 (Sheet 1 of 2)
400 ADF CONTROLS AND INDICATORS

5. TEST - Momentary-on switch used only with ADF function to test bearing reliability. When held depressed, slews indicator pointer; when released, if bearing is reliable, pointer returns to original position.
6. BFO - Pushed in: Activates beat frequency oscillator tone to permit coded identifier of stations transmitting keyed CW signals (Morse Code) to be heard.
7. REC - Pushed in: Selects receive mode (set operates as a standard communications receiver using sense antenna only).

NOTE

When the 400 ADF is in the REC or BFO function, an automatic pointer stow feature will alert the pilot to non-ADF operation by positioning and retaining the pointer at the 3 o'clock position.

8. ADF - Pushed in: Selects ADF mode (set operates as automatic direction finder using fixed loop and sense antennas).
9. PRIMARY PRESELECT LAMP - Lamp will flash only when "primary" (PRI) frequency selection is outside of operating range of the receiver and 1-2 switch is in the "1" position.
10. OFF-VOL - Turns set on or off and adjusts receiver volume.
11. INDEX - Fixed reference line for dial rotation adjustment.
12. POINTER - When HDG or VAR control is adjusted, indicates either relative, magnetic or true bearings of a radio station.
13. HDG or VAR - Rotates dial to facilitate relative, magnetic or true bearing information.

**Figure 7-38 (Sheet 2 of 2)
400 ADF CONTROLS AND INDICATORS**

400 NAV/COM (TYPE RT-485B)

The 400 NAV/COM (Type RT-485B) consists of a panel-mounted receiver-transmitter and a dual pointer remote course deviation indicator (IN-481AC or IN-483AC).

The set includes a 720-channel VHF communications receiver-transmitter and a 200-channel VHF navigation receiver, both of which may be operated simultaneously. The communications receiver-transmitter receives and transmits signals between 118.000 and 135.975 MHz in 25-kHz steps. The navigation receiver receives omni and localizer signals between 108.00 and 117.95 MHz in 50 KHz steps. The circuits required to interpret the omni and localizer signals are located in

the course deviation indicator. Microprocessor frequency management provides storage for 3 pretuned navigation and 3 pretuned communication frequencies in memory.

A "Frequency Memory" voltage is provided so that the preset frequencies are not lost when the receiver is turned off. This voltage is provided directly from the hot battery bus and is present even with the battery switch off. To prevent battery discharge during periods of long term storage, it is recommended the **FREQ MEM** circuit breaker on the right side console be pulled.

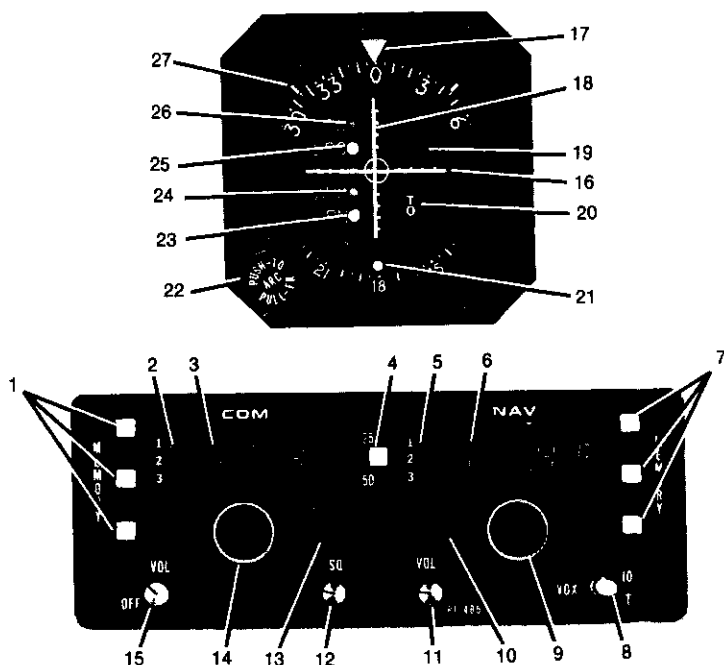
NOTE

If the "Frequency Memory" voltage is interrupted, all stored NAV/COM frequencies will be lost. Subsequent operation with the "Frequency Memory" voltage restored, will require new frequency inputs.

A distance measuring equipment (DME) receiver-transmitter or a glideslope receiver, or both, may be interconnected with the NAV/COM set for automatic selection of the associated DME or glideslope frequency. When a very high frequency omnidirectional and radio range (VOR) frequency is selected on the NAV/COM, the associated VORTAC (VOR/DME) station frequency will also be selected automatically; likewise, if a localizer frequency is selected, the associated glideslope frequency will be selected automatically.

Both course deviation indicators include dual pointers and related NAV and GS flags for both VOR/LOC and glideslope indications. The indicators incorporate a back-course lamp (BC) which lights when optional back course (reversed sense) operation is selected and a RNAV lamp (RN) (IN-483AC indicator only) which, when illuminated, indicates that the navigation system is in the RNAV mode. Indicators with Automatic Radial Centering will, when selected, automatically indicate the radial (bearing) to or from the VOR station.

All controls for the NAV/COM, except the omni bearing selector (OBS) knob, which is located on the course deviation indicator, are mounted on the front panel of the receiver-transmitter, refer to Figure 7-39. In addition, when two or more radios are installed, airplane mounted transmitter selector and speaker/phone switches are provided.



1014P6042
5484P6009L

1. **COM MEMORY 1, 2, and 3 PUSH-BUTTONS** - When a COM MEMORY pushbutton is pressed, the preset frequency will appear in the COM frequency window for use as the operating frequency. Three preset frequencies may be stored in MEMORY and selected as desired, by merely pressing the appropriate COM MEMORY pushbutton to recall the desired operating frequency. If electrical power to the set's "frequency memory" circuit has not been interrupted, upon turn-on, the set will automatically recall the last COM MEMORY frequency selected by a MEMORY pushbutton. If electrical power is removed from the set's "frequency memory" circuit (such as radio removal, battery replacement or pulling the "frequency memory" circuit breaker) upon turn-on, the COM MEMORY circuits will have to be reset and COM 1 MEMORY will automatically be selected with the lowest operating frequency (118.000 MHz) displayed. Pushbutton light dimming is controlled by the RADIO light dimming rheostat knob.

Figure 7-39 (Sheet 1 of 4)
400 NAV/COM CONTROLS PANEL AND INDICATORS

2. **COM MEMORY**
BARS 1, 2, 3 - When a COM MEMORY pushbutton is pressed, the corresponding memory bar is illuminated to indicate which COM MEMORY is in use.
3. **COMMUNICATION OPERATING FREQUENCY**
READOUT - Steady display indicates COM frequency is use. Blinking display indicates a frequency selected during memory storing and not the frequency in use. Third decimal place (either 0 or 5) is not shown on display.
4. **25/50 PUSHBUTTON** - Selects last illuminated decimal place on COM frequency in use. If last decimal place is 2 or 7, pressing 25/50 pushbutton changes number to 5 or 0, respectively. If last decimal place is 5 or 0, pressing 25/50 pushbutton changes number to 7 or 2, respectively. When the last illuminated digit on the set is 2 or 7, the third digit on the set (not shown) will always be 0.
5. **NAV MEMORY**
BAR 1, 2, and 3 - When a NAV MEMORY pushbutton is pressed, the corresponding memory bar is illuminated to indicate which NAV MEMORY is in use.
6. **NAVIGATION OPERATING FREQUENCY**
READOUT - Steady display indicates NAV frequency in use. Blinking display indicates a frequency selected during memory storing and not the frequency in use.
7. **NAV MEMORY 1, 2, and 3 PUSH-BUTTONS** - When a NAV MEMORY pushbutton is pressed, the preset frequency will appear in the NAV frequency window for use as the operating frequency. Three preset frequencies may be stored in MEMORY and selected as desired, by merely pressing the appropriate NAV MEMORY pushbutton to recall the desired operating frequency. If electrical power to the set's "frequency memory" circuit has not been interrupted, upon turn-on, the set will automatically recall the last NAV MEMORY frequency selected by a MEMORY pushbutton. If electrical power is removed from the set's "frequency memory" circuit (such as radio removal, battery replacement or pulling the "frequency memory" circuit breaker) upon turn-on, the NAV MEMORY circuits will have to be reset and NAV 1 MEMORY will automatically be selected with the lowest operating frequency (108.00 MHz) displayed. Pushbutton light dimming is controlled by the RADIO light dimming rheostat knob.

Figure 7-39 (Sheet 2 of 4)
400 NAV/COM CONTROLS PANEL AND INDICATORS

8. **ID-VOX-T SWITCH** - In the ID position, both voice transmission and station identifier signal are heard over the selected navigation frequency; in the VOX (Voice) position, the identifier signal is suppressed and only the voice transmission is heard; in the T (TEST, momentary ON) position, a test signal is sent to the CDI causing a 0 degree FROM bearing indication, the XMIT and AP/CPLD annunciators are illuminated, and the COM and NAV frequency displays show 188.88 with all memory bars illuminated.
9. **NAVIGATION RECEIVER FREQUENCY SELECTORS** - Outer knob changes NAV frequency in 1-MHz steps between 108 and 117 MHz; inner knob changes NAV frequency in 0.05-MHz steps between 0.00 and 0.95 MHz; simultaneously selects paired glideslope frequency and DME channel.
10. **AUTOPILOT COUPLED ANNUNCIATOR (AP/CPLD)** - Illuminates amber when a 400B or 400B IFCS autopilot is coupled to NAV VOR/LOC converter output (non-operational with 400 autopilot).
11. **NAV VOLUME CONTROL (VOL)** - Adjusts volume of navigation receiver audio.
12. **SQUELCH CONTROL** - Used to adjust signal threshold necessary to activate COM receiver audio. Clockwise rotation increases background noise (decreases squelch action); counterclockwise rotation decreases background noise.
13. **TRANSMIT ANNUNCIATOR (XMIT)** - Illuminates green when transmitter output is normal while mike is keyed.
14. **COMMUNICATION RECEIVER FREQUENCY SELECTORS** - Outer knob changes COM frequency in 1-MHz steps between 118 and 135 MHz; inner knob changes COM frequency in 0.05 MHz steps between 0.025 and 0.975 MHz or between 0.000 and 0.950 MHz depending on selection of 25/50 button.
15. **COM OFF-VOLUME CONTROL (OFF-VOL)** - Combination ON/OFF switch and volume control; turns on NAV/COM set and controls volume of COM receiver audio.
16. **GLIDESLOPE DEVIATION POINTER** - Indicates deviation from ILS glideslope.
17. **COURSE INDEX** - Indicates selected VOR course.

**Figure 7-39 (Sheet 3 of 4)
400 NAV/COM CONTROLS PANEL AND INDICATORS**

18. COURSE DEVIATION POINTER - Indicates course deviation from selected omni course or localizer centerline.
19. GLIDESLOPE (GS) FLAG - When visible, indicates unreliable glideslope signal or improperly operating equipment. Flag disappears when a reliable glideslope signal is being received.
20. NAVIGATION (NAV) FLAG AND NAV/TO-FROM INDICATOR - Operates only with a VOR or localizer signal. Red NAV position (flag) indicates unusable signal. With usable VOR signal, indicates whether selected VOR course is TO or FROM station. With usable localizer signal, show TO.
21. RECIPROCAL COURSE INDEX - Indicates reciprocal of selected VOR course.
22. AUTOMATIC RADIAL CENTERING (ARC) PUSH-TO/PULL-FROM SELECTOR - In center detent functions as conventional OBS. Pushed to inner (Momentary On) position, slews OBS course card to center (± 2.5 degree) course deviation indicator with a TO flag, then returns to conventional OBS selection. Pulled to outer detent, continuously slews OBS course card to indicate bearing from VOR station, keeping course deviation pointer centered (± 2.0 degree), with a FROM flag.
23. RN LAMP (IN-483AC ONLY) - Green light illuminated indicates the navigation system is in the RNAV mode and that the vertical pointer indication is for a selected waypoint.
24. AUTOMATIC RADIAL CENTERING (ARC) INDICATOR - Amber light illuminates when Automatic Radial Centering is in use.
25. LOC LAMP - Green light illuminated when a localizer signal is being display by the vertical pointer.
26. BC LAMP - Amber light illuminates when autopilot or reverse sense option is installed and the reverse sense switch or autopilot's back-course button is engaged; indicates course deviation pointer is reversed on selected receiver when tuned to a localizer frequency.
27. COURSE CARD - Indicates selected VOR course under course index.

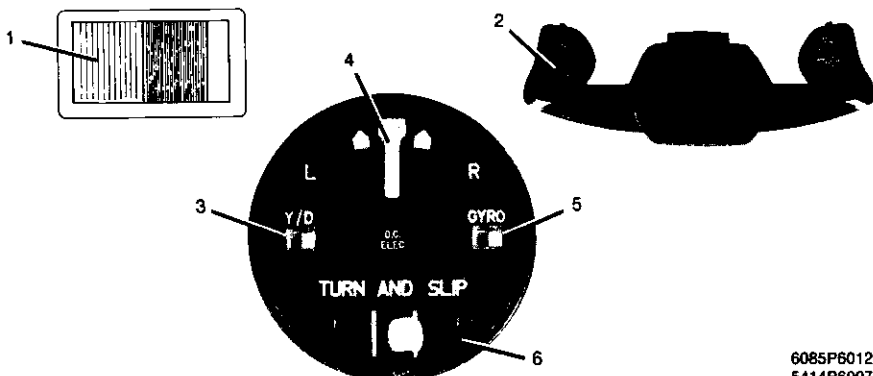
Figure 7-39 (Sheet 4 of 4)
400 NAV/COM CONTROLS PANEL AND INDICATORS

800 YAW DAMPER SYSTEM (TYPE YD-840A)

The yaw damper is an independent system that may be engaged at any time regardless of the state of the autopilot or flight director. When engaged, the yaw damper provides yaw axis stabilization. The panel-mounted gyro computer turn-and-slip indicator provides yaw rate signals to operate the rudder servo.

NOTE

The flags in the turn-and-slip indicator will retract whenever power is applied to this unit.

6085P6012
5414P6007
60856013

1. **YAW DAMPER ON-OFF SWITCH** - Turns yaw damper on and holds it on until switch is turned off or control wheel autopilot disconnect switch is depressed.
2. **CONTROL WHEEL
AUTOPILOT DISCONNECT SWITCH** - When depressed, turns yaw damper off.
3. **Y/D FLAG** - When yellow flag disappears, indicates power is supplied to the yaw damper computer.
4. **RATE-OF-TURN POINTER** - Indicates rate and direction of airplane yaw movement.
5. **GYRO FLAG** - When red flag disappears, indicates power is applied to the gyro.
5. **SLIP INDICATOR** - Indicates slip or skid when ball is displaced from center.

**Figure 7-40
YAW DAMPER CONTROLS AND INDICATOR**

ELECTRIC ELEVATOR TRIM

The electric elevator trim system consists of an electrically operated drive motor and clutch assembly, which receives power through a "momentary on" two-way trim switch and an emergency disengage switch.

CABIN FEATURES

CABIN FIRE EXTINGUISHER

A portable 2.5 pound Halon 1211 fire extinguisher is provided in case of an inadvertent cabin fire. The fire extinguisher, located beneath the copilot's seat, should be checked prior to each flight to ensure that bottle pressure, as indicated by the gage on the bottle, is within the green arc (approximately 125 pounds per square inch). To operate the bottle:

1. Loosen the retaining clamp and remove extinguisher from bracket.
2. Hold bottle upright, pull retaining pin, and press lever to discharge.

NOTE

● *Begin discharge 5 feet from fire, at base of the flame, and sweep as required across the flame.*

● *Extinguisher should be recharged after each use.*

3. After discharging a fire extinguisher, ventilate the cabin.

—

—

SECTION 8 HANDLING, SERVICE AND MAINTENANCE

TABLE OF CONTENTS

| | Page |
|--|------|
| INTRODUCTION | 8-3 |
| Publications | 8-3 |
| Cessna Owner Advisories | 8-4 |
| Cessna Service Information Subscription Program | 8-5 |
| AIRPLANE INSPECTION PERIODS | 8-5 |
| Cessna Continuous Inspection Program | 8-5 |
| Cessna Customer Care Program | 8-6 |
| CESCOM System | 8-6 |
| Engine Condition Trend Monitoring | 8-6 |
| Servicing Requirements | 8-8 |
| Airplane File | 8-9 |
| PREVENTIVE MAINTENANCE THAT MAY BE ACCOMPLISHED BY A CERTIFICATED PILOT | 8-10 |
| ALTERATIONS OR REPAIRS TO AIRPLANE | 8-10 |
| GROUND HANDLING | 8-11 |
| Towing | 8-11 |
| Parking | 8-12 |
| Tie-Down | 8-12 |
| Jacking and Leveling | 8-13 |
| SERVICING | 8-13 |
| Cabin Fire Extinguisher | 8-14 |
| Fuel | 8-14 |
| Fuel Additive | 8-15 |
| Fuel Contamination | 8-18 |
| Oil | 8-19 |
| Oxygen | 8-21 |
| Landing Gear Hydraulic Reservoir | 8-22 |
| Alcohol Windshield Deice Reservoir | 8-22 |
| Tires | 8-22 |
| Flush Toilet Reservoir | 8-22 |
| Light Bulb Replacement | 8-23 |
| Fuse and Fuse Limiter Replacement | 8-27 |
| CLEANING AND CARE | 8-28 |
| Exterior Cleaning | 8-28 |
| Interior Cleaning | 8-31 |
| PROLONGED OUT-OF-SERVICE CARE | 8-35 |

LIST OF FIGURES

| Figure | Page |
|--|------|
| 8-1 Approved Fuel Grades | 8-14 |
| 8-2 EGME Additive Mixing Ratio | 8-17 |
| 8-3 Approved Oil | 8-20 |
| 8-4 Oxygen Servicing Chart | 8-22 |
| 8-5 Light Bulb Replacement Guide | 8-23 |
| 8-6 Landing Gear Position Lights | 8-24 |
| 8-7 Compass Light | 8-24 |
| 8-8 Instrument Post Lights | 8-25 |
| 8-9 Annunciator Panel Lights | 8-25 |
| 8-10 Ignition Lights | 8-26 |
| 8-11 Marker Beacon, Autopilot Off and Altitude Alert Lights | 8-26 |
| 8-12 Fuse and Fuse Limiter Replacement Guide | 8-27 |

INTRODUCTION

Section 8 of this handbook provides information on cleaning, inspection, servicing and maintenance of the airplane.

If your airplane is to retain the new plane performance and dependability, certain inspection and maintenance requirements must be followed. It is wise to follow a planned schedule of lubrication and preventive maintenance based on climatic and flying conditions encountered in your locality.

NOTE

It is the responsibility of the owner to ensure that all airworthiness directives and maintenance of the airplane are done when required and in accordance with Federal Aviation Regulations.

Keep in touch with your Cessna Service Facility, and take advantage of their knowledge and experience. They know your airplane and how to maintain it and will remind you when lubrications and oil changes are necessary, and about other seasonal and periodic services.

All correspondence concerning your airplane should include the airplane model and serial number. This information may be obtained from the FAR-45 required identification plate located on the forward door post. Refer to the Airplane Maintenance Manual for an illustration of the identification plate.

PUBLICATIONS

Various publications and flight operation aids are furnished in the airplane when delivered from the factory. These items are listed as follows:

CESCOM/CUSTOMER CARE PROGRAM HANDBOOK
CESCOM INSTRUCTION MANUAL AND AIRPLANE
STATUS REPORT BINDER
PILOT'S OPERATING HANDBOOK AND FAA APPROVED
AIRPLANE FLIGHT MANUAL
PILOT'S CHECKLIST
DEALER DIRECTORY
AVIONICS WIRING DIAGRAMS

The following additional publications, plus many other supplies that are applicable to your airplane, are available from your Cessna Service Facility.

INFORMATION MANUAL (Contains Pilot's Operating Handbook and FAA Approved Airplane Flight Manual Information)
MAINTENANCE MANUALS, PARTS CATALOGS AND WIRING DIAGRAM MANUAL FOR YOUR AIRPLANE
ENGINE AND ACCESSORIES
AVIONICS EQUIPMENT

Your Cessna Service Facility has a Customer Care Supplies and Publications Catalog covering all available items, many of which they keep on hand. They will be happy to place an order for any item which is not in stock.

NOTE

A Pilot's Operating Handbook and FAA Approved Airplane Flight Manual which is lost or destroyed may be replaced by contacting your Cessna Service Facility. An affidavit containing the owner's name, airplane serial number and registration number must be included in replacement requests since the Pilot's Operating Handbook and FAA Approved Airplane Flight Manual is identified for specific airplanes only.

CESSNA OWNER ADVISORIES

Cessna Owner Advisories are sent to Cessna airplane owners at no charge to inform them about mandatory and/or beneficial airplane service requirements and product improvements:

United States Aircraft Owners

If the aircraft is registered in the U.S., appropriate Cessna Owner Advisories are mailed automatically according to the latest aircraft registration name and address provided to the FAA.

If the owner requires a duplicate Owner Advisory to be sent to an address different than the FAA aircraft registration address, the owner must complete and return an Owner Advisory Application, form D5514-13 (otherwise no action is required on the owner's part).

International Aircraft Owners

To receive Cessna Owner Advisories, International aircraft owners must complete and return an Owner Advisory Application, form D5514-13.

Receipt of a valid Owner Advisory Application will establish the Cessna Owner Advisory service (duplicate Owner Advisory service for U.S. aircraft owners) for one year, after which the owner will be sent a renewal notice.

CESSNA SERVICE INFORMATION SUBSCRIPTION PROGRAM

A subscription service for Caravan II Service Bulletins is available directly from the Cessna Customer Services Department. Your Cessna Service Facility will be pleased to supply you with details concerning this subscription program, and stands ready, through his Service Department, to supply you with fast and efficient service.

AIRPLANE INSPECTION PERIODS

Federal Aviation Regulations Part 91.169 (e) defines the inspection requirements for turbopropeller-powered multiengine airplanes. Chapter 5 of the Airplane Maintenance Manual contains the inspection program recommended by Cessna Aircraft Company.

Additional inspections may be required by the FAA. These inspections are issued in the form of Airworthiness Directives and can apply to the airframe, engines and/or components of the airplane. It is the owner's responsibility to ensure compliance with these directives. In some cases, the Airworthiness Directives require repetitive compliance; therefore, the owner should ensure inadvertent noncompliance does not occur at future inspection intervals.

NOTE

Refer to FAR Parts 43 and 91 for properly certificated agency or personnel to accomplish the inspections. Contact your local Cessna Service Facility for additional information.

CESSNA CONTINUOUS INSPECTION PROGRAM

The Cessna Continuous Inspection Program has been developed to provide a modern continuous inspection schedule that satisfies the complete airplane inspection requirements and to help you realize maximum utilization of your airplane at a minimum cost and down-time. Under this program, your airplane is inspected and maintained in a 600 hour cycle. This cycle is composed of six phases with a phase being performed at 50 hour intervals.

The procedures for the Cessna Continuous Inspection Program have been carefully worked out by the factory and are followed by the Cessna Dealer Organization. The complete familiarity of Cessna Dealers with Cessna equipment and factory-approved procedures provides the highest level of service possible to Cessna owners.

CESSNA CUSTOMER CARE PROGRAM

Specific benefits and provisions of the Cessna Warranty for your airplane plus other important benefits for you are contained in your CESCO/ Customer Care Program Handbook supplied with your airplane. You will want to thoroughly review this publication and keep it in your airplane at all times.

CESCOM SYSTEM

CESCO is Cessna's Computerized Maintenance Records System. This comprehensive system provides you with an accurate and simple method of monitoring and scheduling inspections, Caravan II Service Bulletins, Service Kits, Airworthiness Directives as well as scheduled and unscheduled maintenance activities. For detailed information about CESCO, refer to the CESCO Instruction Manual supplied with your airplane.

ENGINE CONDITION TREND MONITORING

Pratt and Whitney Canada Inc. Engine Condition Trend Monitoring is a system of recording engine instrument readings, correcting the readings for ambient conditions, and comparing actual engine operation to typical engine operating characteristics.

It has been established that engine operating characteristics, such as output torque (Tq), propeller RPM (Np), interturbine temperature (ITT), gas generator RPM (Ng), and fuel flow (Wf) are predictable for various engine types under specific ambient conditions.

Because airplane engines operate at a wide range of altitudes, outside air temperatures, and airspeeds, corrections for varying ambient conditions are also incorporated into the Trend Monitoring process.

During operation, engine gas path components (compressor as well as turbine) are exposed to internal and external factors which can deteriorate the airfoil surfaces, which in turn can degrade the operating efficiency of the engine. Accomplishment of Engine Condition Trend Monitoring allows compressor and/or turbine deterioration to be detected, and in turn, alerts the operator/maintenance facility that corrective maintenance action may be needed.

Engine Condition Trend Monitoring is an integral feature of the Cessna CESCO program. Accomplishment of Trend Monitoring, utiliz-

ing the Cessna CESCO system, is relatively simple and consists of three primary activities:

- Regular recording of instrument readings by the airplane operator on the Aircraft Flight Record.
- Processing, plotting, and reporting of fuel flow (Wf), inter-turbine temperature (ITT), and gas generator RPM (Ng) deltas (deviations) by CESCO.
- Analysis and review of the reported Trend Monitoring report by the operator's maintenance facility.

To ensure maximum accuracy, it is **ESSENTIAL** to minimize as many errors as possible when recording engine instrument readings. Sources of error include visual parallax, imprecise interpretation of instrument readings, poor instrument accuracy, and poor instrument repeatability. Precise engine instrument operation and recording are absolutely necessary to successfully accomplishing Trend Monitoring.

Trend Monitoring instrument readings should be accomplished each fourth flight, with the engine adjusted to normal cruise power, for a stabilized period of not less than five minutes. The airplane inertial separator should be in the **NORMAL** position, and the anti-ice/deice equipment, air conditioning, and bleed air (cabin heat) should be turned off.

Following the stabilized cruise period, **ACCURATE** engine readings should be taken and **PRECISELY** recorded in the appropriate section of the Aircraft Flight Record.

NOTE

To obtain accurate readings, parallax error must be minimized by viewing each instrument from a zero-degree angle (i.e., straight ahead).

By regularly accomplishing the items previously described, CESCO users can use the CESCO provided Trend Monitoring report to monitor engine operating efficiency and to identify and plan future maintenance activities with their maintenance facility.

For those operators not using CESCO, two additional methods may be used to accomplish Trend Monitoring:

- P & WC Compu-Trend 2, which utilizes a Hewlett-Packard HP41CV model programmable hand-held calculator and optional printer.
- P & WC Compu-Trend 3, which consists of a computer program written in BASIC for an IBM Personal Computer.

Additional information about both of these methods may be obtained from:

Pratt and Whitney Canada Inc.
Box 10, Longueuil, Quebec
Canada, J4K 4X9

Attention: Customer Support, Small Turboprops Mail
Code: 1RC1

Trend Monitoring should be implemented when the engine is new or newly overhauled.

For additional information on Trend Monitoring, refer to the CESC-OM Instruction Manual supplied with your airplane, and Pratt and Whitney Canada Aircraft Inc. Gas Turbine Operation Information Letters, Number 10 and Number 23.

SERVICING REQUIREMENTS

For quick and ready reference, quantities, materials, and specifications for frequently used service items (such as fuel, oil, etc.) are shown in this section.

In addition to the Preflight Inspection covered in Section 4, complete servicing, inspection, and test requirements for your airplane are detailed in the Airplane Maintenance Manual. The Maintenance Manual outlines all items which require attention at 50-, 100-, 200- and 600-hour intervals plus those items which require servicing, inspection, and/or testing at special intervals.

It is recommended that you contact your Cessna Service Facility concerning these requirements and begin scheduling your airplane for service at the recommended intervals.

Depending on various flight operations, your local government aviation agency may require additional service, inspections, or tests. For these regulatory requirements, owners should check with local aviation officials where the airplane is being operated.

AIRPLANE FILE

There are miscellaneous data, information and licenses that are a part of the airplane file. The following is a checklist for that file. In addition, a periodic check should be made of the latest Federal Aviation Regulations to ensure that all data requirements are met.

- a. To be displayed in the airplane at all times:
 - (1) Standard Airworthiness Certificate (FAA Form 8100-2).
 - (2) Aircraft Registration Certificate (FAA Form 8050-3).
 - (3) Aircraft Radio Station License, (if Transmitter is installed, Federal Communication Commission Form 556).
 - (4) Radio Telephone Station License (Federal Communication Commission Form 409, if Flitefone Radio Telephone is installed).
- b. To be carried in the airplane at all times:
 - (1) Weight and Balance Data Sheets and associated papers (all copies of the Repair and Alteration Form, FAA Form 337, if applicable).
 - (2) Equipment List.
 - (3) Pilot's Operating Handbook and FAA Approved Airplane Flight Manual.
 - (4) Pilot's Checklist.
- c. To be made available upon request:
 - (1) Airframe Maintenance Records.
 - (2) Engine Maintenance Records.
 - (3) Propeller Maintenance Records.

Most of the items listed are required by the United States Federal Aviation Regulations. Since the regulations of other nations may require other documents and data, owners of airplanes not registered in the United States should check with their own aviation officials to determine their individual requirements.

Cessna recommends you also carry your CESCO/Customer Care Program Handbook, Customer Care Card and Pilot's Abbreviated Checklist in the airplane at all times.

PREVENTIVE-MAINTENANCE THAT MAY BE ACCOMPLISHED BY A CERTIFICATED PILOT

Part 43 of the FAR's allows the holder of a pilot certificate, issued under Part 61, to perform preventive maintenance on any airplane owned or operated by him that is not used in air carrier service. Refer to FAR Part 43 for a list of preventive maintenance items the pilot is authorized to accomplish.

NOTE

- *Pilots operating airplanes of other than United States registry should refer to the regulations of the country of certification for information on preventive maintenance that may be performed by pilots.*
- *All maintenance other than preventive maintenance must be accomplished by appropriately licensed personnel. Contact your Cessna Service Facility for additional information.*
- *Prior to performance of preventive maintenance, review the applicable procedures in the Airplane Maintenance Manual to ensure the procedure is properly completed.*

ALTERATIONS OR REPAIRS TO AIRPLANE

Alterations or repairs to the airplane must be accomplished by appropriately licensed personnel. If alterations are considered, the FAA should be consulted to ensure that the airworthiness of the airplane is not violated.

GROUND HANDLING

TOWING

The airplane should be moved on the ground with the aid of the nosewheel towing bar provided with the airplane. The tow bar is designed to attach to the nose gear strut fork.



REMOVE/RELEASE ALL CONTROL LOCKS BEFORE GROUND HANDLING. WHEN USING THE TOW BAR, NEVER EXCEED THE PLACARD NOSEWHEEL TURNING RADIUS LIMITS SHOWN ON THE NOSE GEAR STRUT (APPROXIMATELY 50 DEGREES EITHER SIDE OF CENTER). STRUCTURAL DAMAGE CAN OCCUR IF THE TURN LIMITS ARE EXCEEDED (AN INSPECTION OF THE NOSE GEAR STOP BLOCKS MUST BE MADE PER THE AIRPLANE MAINTENANCE MANUAL IF TURN LIMITS ARE EXCEEDED). DO NOT PUSH OR PULL ON PROPELLERS OR CONTROL SURFACES WHEN MOVING THE AIRPLANE ON THE GROUND.

Should towing operations be required which cannot be accomplished with the nosewheel towing bar, the airplane can be towed using a yoke-type tow bar and a tow vehicle.

A qualified person should be stationed in the pilot seat during all phases of towing to watch for hazardous conditions and to stop the airplane with the airplane brakes in the event the tow bar breaks or becomes uncoupled. In congested areas, station wing and/or tail walkers to ensure adequate clearance between airplane and adjacent equipment and structures.

Refer to the airplane maintenance manual for additional towing procedure information.

PARKING

Parking is normally accomplished with the nosewheel aligned straight ahead. This minimizes stress on the nose gear during starting and simplifies the steering during subsequent departures from the parking area. If gusty wind conditions prevail, lock the controls to prevent unnecessary control surface movement. When parking the airplane, head into the wind and set the parking brake.



DO NOT SET PARKING BRAKES WHEN THE BRAKES ARE OVERHEATED OR DURING COLD WEATHER WHEN ACCUMULATED MOISTURE MAY FREEZE THE BRAKES.

When setting the parking brake is impractical, chock the main and nose wheels to prevent airplane movement.

TIE-DOWN

Proper tie-down procedure is the best precaution against damage to a parked airplane by gusty or strong winds. To tie-down the airplane securely, proceed as follows:

1. Head airplane into the wind, if possible.
2. Set parking brake, and install/set control locks to restrict travel of all moveable surfaces.



DO NOT SET PARKING BRAKE WHEN THE BRAKES ARE OVERHEATED OR DURING COLD WEATHER WHEN ACCUMULATED MOISTURE MAY FREEZE THE BRAKES.

3. Install pitot tube covers, if available.
4. Set elevator, aileron and rudder trim tabs to neutral so that the trim tabs fair with the control surfaces.
5. Install control column lock in the pilot's control column, if available. If column lock is not available, tie the pilot's control wheel full aft with a seat belt.

6. If dusty conditions exist or if the last flight of the day has been completed, install the engine inlet and exhaust covers to protect the engines from debris. The covers may be installed after the engines have cooled down (Inter turbine temperature indicators showing "off scale" temperatures).
7. Attach ropes or chains of at least 700 pounds tensile strength to the three tie-down fittings. Secure the opposite ends of the ropes or chains to ground anchors. Two of the tie-down fittings are located outboard of the nacelle on the main spar. The third tie-down fitting is the tailcone tail skid. For further security, tie nose gear with a rope attached above the nose gear torque link. The other end should be attached to a substantial ground anchor. The rope angle to the ground should be 45 degrees. Attach a second rope in a similar manner to the opposite side of the nose gear. Ensure that the rope will not chafe on the nose gear or that damage will not occur to the nose gear.

JACKING AND LEVELING

Three jack points are provided on the underside of the airplane. One jack point is located just aft of the nosewheel well, and one is located on the lower surface of each wing, inboard and in-line with the wing flap hinge.

NOTE

● *Ensure both generator switches are off to prevent the flight hour recorder from recording while the airplane is on jacks and battery switch is in the ON position.*

● *Jacks, ideally suited to the airplane, can be supplied by the Cessna Aircraft Company. Three jacks are required to lift the airplane.*

To level the airplane longitudinally and laterally, use the three jacking points provided on the airplane. Level longitudinally by backing out the two screws at "Level Point" on the right outside fuselage (opposite cabin door) at Stations 248.25 and 272.65 and place a spirit level on these screws, then level longitudinally. To level laterally, place a spirit level at Station 177.45 (centerline of front spar) on underside of fuselage. Refer to the Airplane Maintenance Manual for additional information.

SERVICING

In addition to the PREFLIGHT INSPECTION covered in Section 4, COMPLETE servicing, inspection, and test requirements for your airplane are detailed in the Maintenance Manual.

CABIN FIRE EXTINGUISHER

The cabin fire extinguisher is attached to the lower front seat structure of the copilot's seat. On a regular basis, check the following:

1. Check fire extinguisher for secure attachment to copilot's seat.
2. Check yellow plastic tamper tag for condition.
3. Ensure trigger safety lock ring is installed.
4. Check pressure gage for correct indication. If extinguisher is weighed, it should weigh at least 4.5 pounds. If the extinguisher weighs less than 4.5 pounds, remove the extinguisher for inspection and recharging by a qualified fire extinguisher agency. Such agencies are listed under "Fire Extinguishers" in the telephone directory.
5. Approximately 8 seconds of use is available in a fully serviced extinguisher.

FUEL

Care should be exercised during fueling operations to avoid damaging deice boots with fueling hose.

| FUEL GRADE | FUEL SPECIFICATIONS | MINIMUM FUEL TEMPERATURE FOR TAKEOFF - °C | SPECIFIC WEIGHT POUNDS PER U.S. GALLON AT 60°F | COLOR |
|----------------------------------|--------------------------|---|--|--|
| JET A | ASTM-D1655 | -31 | 6.7 | COLORLESS |
| JET A-1 | ASTM-D1655 | -31 | 6.7 | COLORLESS |
| JET B | ASTM-D1655 | -54 | 6.7 | COLORLESS |
| JP-1 | MIL-L-5616 | -54 | 6.7 | COLORLESS |
| JP-4 | MIL-T-5624 | -54 | 6.5 | COLORLESS |
| JP-5 | MIL-T-5624 | -31 | 6.8 | COLORLESS |
| JP-8 | MIL-T-83133A | -31 | 6.7 | COLORLESS |
| * AVIATION GASOLINE (ALL GRADES) | MIL-G-5572 AND ASTM-D910 | -54 | 6.0 | 80/87 RED, 100 GREEN, 100LL BLUE |

* Aviation gasoline (All Grades) is approved for emergency use only. A record of total aviation gasoline used must be recorded in the Airplane Engine Maintenance Record.

NATO equivalents of the above fuels may be used.

Figure 8-1
APPROVED FUEL GRADES

Alternate/Emergency Fuels

Aviation gasoline, all grades, are restricted to emergency use.

CAUTION

● **AVIATION GASOLINE IS RESTRICTED TO EMERGENCY USE AND SHALL NOT BE USED FOR MORE THAN 150 HOURS IN ONE OVERHAUL PERIOD.**

● **A MIXTURE OF ONE PART AVIATION GASOLINE AND THREE PARTS OF JET A, JET A-1, JP-1, OR JP-5 MAY BE USED FOR EMERGENCY PURPOSES FOR A MAXIMUM OF 450 HOURS PER OVERHAUL PERIOD.**

● **AUXILIARY BOOST PUMP MUST BE ON WHEN USING AVIATION GASOLINE.**

FUEL ADDITIVE

A variety of fuels may be used in the airplane; however, each must have an anti-icing additive compound, in compliance with MIL-I-27686E, incorporated or added into the fuel during refueling.

WARNING

ANTI-ICING ADDITIVES CONTAINING EGME ARE HARMFUL IF INHALED, SWALLOWED, OR ABSORBED THROUGH THE SKIN, AND WILL CAUSE EYE IRRITATION. ALSO, IT IS COMBUSTIBLE. BEFORE USING THIS MATERIAL, REFER TO ALL SAFETY INFORMATION ON THE CONTAINER.

CAUTION

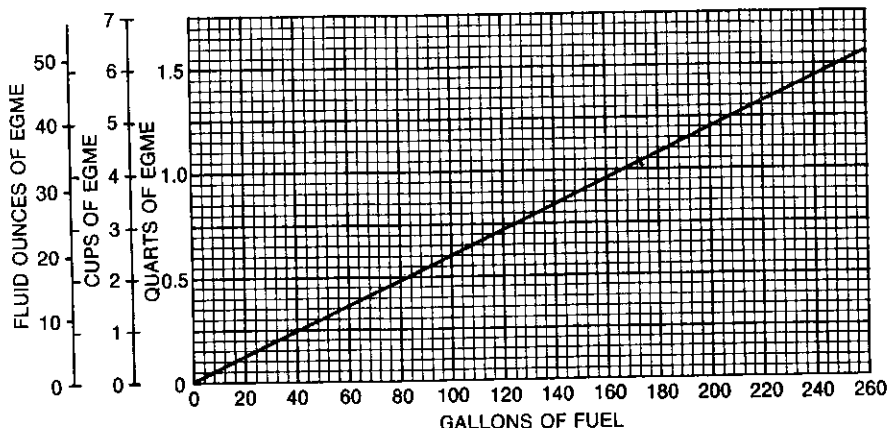
JP-4 AND JP-5 FUELS PER MIL-T-5624 AND JP-8 FUEL PER MIL-T-83133A CONTAIN THE CORRECT PREMIXED QUANTITY OF AN APPROVED TYPE OF ANTI-ICING FUEL ADDITIVE AND NO ADDITIONAL ANTI-ICE COMPOUNDS SHOULD BE ADDED.

Ethylene glycol monomethyl ether (EGME) compound in compliance with MIL-I-27686E, must be carefully mixed with the fuel in concentrations not to exceed 0.15 percent by volume. The minimum EGME concentration within the fuel tank is 0.035 percent by volume. The minimum EGME concentration for fuel being added to the fuel tank is 0.060 percent by volume.

CAUTION

● *MIXING OF THE EGME COMPOUND WITH THE FUEL IS EXTREMELY IMPORTANT BECAUSE CONCENTRATION IN EXCESS OF THAT RECOMMENDED (0.15 PERCENT BY VOLUME MAXIMUM) WILL RESULT IN DETRIMENTAL EFFECTS TO THE FUEL TANKS, SUCH AS DETERIORATION OF PROTECTIVE PRIMER AND SEALANTS AND DAMAGE TO O-RINGS AND SEALS IN THE FUEL SYSTEM AND ENGINE COMPONENTS. USE ONLY BLENDING EQUIPMENT THAT IS RECOMMENDED BY THE MANUFACTURER TO OBTAIN PROPER PROPORTIONING.*

● *DO NOT ALLOW THE CONCENTRATED EGME COMPOUND TO COME IN CONTACT WITH THE AIRPLANE FINISH OR FUEL CELL AS DAMAGE CAN RESULT.*



60856021

Figure 8-2
EGME ADDITIVE MIXING RATIO

Prolonged storage of the airplane will result in a water buildup in the fuel which "leaches out" the additive. An indication of this is when an excessive amount of water accumulates in the fuel tank sumps. The concentration can be checked using a anti-ice concentration test kit (Part Number CJMD128-002 available from Cessna Aircraft Company Supply Division, 5800 E. Pawnee, Wichita, Ks. 67218). It is imperative that the technical manual for the kit be followed explicitly when checking the additive concentration. The minimum additive concentration shall be 0.035 percent by volume and maximum concentration shall be 0.15 percent by volume.

If anti-static protection or additional biocidal protection is desired, the following additives are approved for use:

1. Shell ASA-3 anti-static additive, or equivalent, may be used in amounts to bring the fuel up to 300 conductivity units, but in no event shall the additive exceed 1 part per million by weight.
2. Dupont Stadis 450 Anti-ice, or equivalent, may be used in amounts to bring the fuel up to 300 conductivity units, but in no event shall the additive exceed 3 part per million by weight.

If additional biocidal protection is desired, an additive is permitted for use in certain conditions. Fuel tank maintenance practices are of prime importance in controlling microbial growth. However, other factors such as climate, airplane design, route structure and utilization also affect microbial growth; therefore, occasional use of a biocide may be required. Biocide additive may be used on a limited basis, defined as intermittent

or noncontinuous use in a single application, to sterilize airplane fuel systems suspected, or found to be contaminated by microbial organisms. For those operators, where the need for biocide use is dictated, Pratt and Whitney Canada Inc. recommends, as a guide, a dosage interval of once a month. This interval can then be adjusted, either greater or lesser, as an operator's own experience dictates. An engine operated in private and corporate airplanes, where utilization rates are relatively low, may use the additive continuously. The following additive is permitted for use:

1. Sohio Biodor JF biocide additive, or equivalent, may be used in the fuel at a concentration not to exceed 270 parts per million by weight (20 parts per million elemental boron).

FUEL CONTAMINATION

Fuel contamination is usually the result of foreign material present in the fuel system, and may consist of water, rust, sand, dirt, microbes or bacterial growth. In addition, additives that are not compatible with fuel or fuel system components can cause the fuel to become contaminated.

Before the first flight of the day and after each refueling, use the fuel sampler and drain fuel from the fuel tank sump drains, the fuel strainer drains and the crossfeed line drains to determine if contaminants are present, and that the airplane has been fueled with the proper grade and type of fuel.

If contamination is detected, continue draining from all fuel drain points until all contamination has been removed. If the airplane has been serviced with the improper fuel grade, defuel completely and refuel with the correct grade. Do not fly the airplane with contaminated or unapproved fuel.

In addition, Owners/Operators who are not acquainted with a particular fixed base operator should be assured that the fuel supply has been checked for contamination and is properly filtered before allowing the airplane to be serviced. Also, fuel tanks should be kept full between flights, provided weight and balance considerations will permit, to reduce the possibility of water condensing on the walls of partially filled tanks.

To further reduce the possibility of contaminated fuel, routine maintenance of the fuel system should be performed in accordance with the airplane Maintenance Manual. Only the proper fuel, as defined in Section 2 of this handbook, should be used, and fuel additives should not be used unless approved by Cessna and the Federal Aviation Administration.

OIL

WARNING

PERSONS WHO HANDLE ENGINE OIL ARE ADVISED TO MINIMIZE SKIN CONTACT WITH USED OIL, AND PROMPTLY REMOVE ANY USED OIL FROM THEIR SKIN. A LABORATORY STUDY, WHILE NOT CONCLUSIVE, FOUND SUBSTANCES WHICH MAY CAUSE CANCER IN HUMANS. THOROUGHLY WASH USED OIL OFF SKIN AS SOON AS POSSIBLE WITH SOAP AND WATER. DO NOT USE KEROSENE, THINNERS OR SOLVENTS TO REMOVE USED ENGINE OIL. IF WATERLESS HAND CLEANER IS USED, ALWAYS APPLY SKIN CREAM AFTER USING.

The oils listed in Figure 8-3 comply with the engine manufacturers specifications. These oils are fully approved for use in Pratt and Whitney Canada Inc. commercially operated engines.

When adding oil, service the engines with the type and brand which is currently being used in the engines. Refer to the airplane and engine maintenance records.

CAUTION

Mixing of different brands of oils or viscosities of oils is not allowed; should oils of different brands or viscosities be inadvertently mixed, the oil system servicing instructions in the airplane's Maintenance Manual shall be carried out.

| OIL BRAND AND TRADE NAME | VISCOSITY TYPE RATING | APPLICABLE SPECIFICATION | OIL DRAIN PERIOD |
|--------------------------------------|-----------------------|--------------------------|------------------|
| Aero Shell Turbine Oil 500 | Type II | PWA 521 | See Note 2 |
| Aero Shell Turbine Oil 555 | Type II | PWA 521 | See Note 2 |
| Royco Turbine Oil 500 | Type II | PWA 521 | See Note 2 |
| Royco Turbine Oil 555 | Type II | PWA 521 | See Note 2 |
| Mobil Jet Oil II | Type II | PWA 521 | See Note 2 |
| Mobil Jet Oil 254 | Type II | PWA 521 | See Note 2 |
| Castrol 5000 | Type II | PWA 521 | See Note 2 |
| Esso Turbo Oil 2380 (See Note 1) | Type II | PWA 521 | See Note 2 |
| Exxon Turbo Oil 2380 (See Note 1) | Type II | PWA 521 | See Note 2 |

NOTE:

1. "Esso" and "Exxon" are interchangeable trade names dependent solely on marketing region. These brands are identical and may be intermixed.
2. Oil Drain Period.
 - a. For engines operated in corporate or utility airplanes with utilization of 50 hours per month or less, it is recommended that the oil be changed every 400 hours or 12 calendar months, whichever occurs first.
 - b. For engines operated in commuter airplane-type operations with utilization of more than 50 hours per month, it is recommended that the oil be changed every 1200 hours or 12 calendar months, whichever occurs first.
 - c. If operating in sandy or dusty environment, regardless of the utilization, the oil change interval of 12 calendar months must be reduced to every 6 calendar months or less depending upon the severity of the environment.

**Figure 8-3
APPROVED OIL**

Oil Quantity Operating Range

Fill to within 2 quarts of MAX HOT or MAX COLD (as appropriate) on dipstick. Quart markings indicate U.S. quarts low if oil is hot. For example, a dipstick reading of 3 indicates the system is within 2 quarts of MAX if oil is cold and within 3 quarts of MAX if the oil is hot.

NOTE

To obtain an accurate oil level reading, it is recommended the oil level be checked within 10 minutes after engine shutdown while the oil is hot (MAX HOT marking) or prior to the first flight of the day while the oil is cold (MAX COLD marking). If more than 10 minutes has elapsed since engine shutdown and engine oil is still warm, perform an engine dry motoring run before checking oil level.

OXYGEN (Aviators Breathing Oxygen - Specification MIL-O-27210)

Check pressure gage for anticipated requirements before each flight. Refill whenever pressure drops below 300 pounds per square inch.

The oxygen cylinder, when fully charged and allowed to stabilize at a temperature of 21.1 degrees Celsius, contains approximately 114.9 cubic feet of oxygen under a pressure of 1850 pounds per square inch. Filling pressures will vary, however, due to the ambient temperature in the filling area, and because of the temperature rise resulting from compression of the oxygen. Because of this, merely filling to 1800 or 1850 pounds per square inch will not result in a properly filled cylinder. Fill to the pressures indicated in Figure 8-4 for the ambient temperature.

WARNING

OIL, GREASE, OR OTHER LUBRICANTS IN CONTACT WITH OXYGEN CREATE A SERIOUS FIRE HAZARD, AND SUCH CONTACT MUST BE AVOIDED WHEN HANDLING OXYGEN EQUIPMENT.

The cylinder is normally serviced through a filler valve located on the forward face of the left nose baggage door jamb. Variations in optional avionics installations may in some cases require that the cylinder be serviced through the right nose baggage door in a similar manner.

| AMBIENT TEMPERATURE | | FILLING PRESSURE | AMBIENT TEMPERATURE | | FILLING PRESSURE |
|---------------------|----|------------------|---------------------|-----|------------------|
| °C | °F | PSIG | °C | °F | PSIG |
| -17.8 | 0 | 1600 | 21.1 | 70 | 1925 |
| -12.2 | 10 | 1650 | 26.7 | 80 | 1950 |
| -6.7 | 20 | 1675 | 32.2 | 90 | 2000 |
| -1.1 | 30 | 1725 | 37.8 | 100 | 2050 |
| 4.4 | 40 | 1775 | 43.3 | 110 | 2100 |
| 10.0 | 50 | 1825 | 48.9 | 120 | 2150 |
| 15.6 | 60 | 1875 | 54.4 | 130 | 2200 |

THE NUMBERS SHOWN ABOVE ARE APPLICABLE TO 1800 PSI OXYGEN BOTTLES. IF AN 1850 PSI OXYGEN BOTTLE IS INSTALLED. INCREASE EACH FILLING PRESSURE BY 50 PSI.

Figure 8-4
OXYGEN SERVICING CHART

LANDING GEAR HYDRAULIC RESERVOIR (Hydraulic Fluid MIL-H-5606)

Check the reservoir fluid level; fill as required to maintain fluid level between the ADD and MAX FULL marks. Reservoir capacity is approximately 1.2 quarts when landing gear is down and locked.

ALCOHOL WINDSHIELD DEICE RESERVOIR (Isopropyl Alcohol MIL-F-5566) (Optional System)

Check reservoir fluid level; fill as required. Reservoir capacity is 3.0 gallons. Reservoir is located in right nose baggage compartment.

TIRES

Tire pressure should be maintained at 95 pounds per square inch for main wheel tires and 50 pounds per square inch for nosewheel tire.

FLUSH TOILET RESERVOIR

The optional flush toilet uses a reservoir tank that contains water and chemicals. The reservoir tank should be removed and serviced after excessive use or after 35 or 40 cycles of the system. Service the reservoir with a 2-quart solution of water and a 3-ounce package of Monogram DG-19 or Chemkare chemical.

NOTE

During cold weather operation, where cabin temperatures can fall below 0 degrees Celsius (32 degrees Fahrenheit), an ethylene glycol base anti-freeze should be added to the reservoir tank to prevent freezing of the flush solution.

LIGHT BULB REPLACEMENT

The following table, refer to Figure 8-5, is a light bulb replacement guide. Light bulbs which can reasonably be changed by the pilot are indicated by an asterisk (*) preceding the item.

| LIGHT - (LOCATION) | BULB QUANTITY/ AIRPLANE | BULB PART/NUMBER |
|--|----------------------------|---------------------|
| Exterior (Standard) | | |
| Navigation Lights (Wings) | 2 | 628 |
| Navigation Light (Tail) | 1 | MS35478-305 |
| Landing Lights (Left and Right) | 2 | MS25241-4553 |
| Taxi Light (Nose Gear) | 1 | 4594 |
| Anti-Collision Lights | 2 | 31-3172-27 |
| Wing Deice Light (Left and Right) | 2 | 900-330-00 |
| Exterior (Optional) | | |
| Wing Tip Recognition Lights | 2 | 55-1042-1 |
| Oscillating Beacon Ground Recognition Lights | 4 | A-7079B-24 |
| Interior | | |
| *Landing Gear Position Lights | 4 | MS25237-327 |
| *Landing Gear Unlocked Light | 2 | MS25237-327 |
| *Compass Light | 1 | MS25237-327 |
| *Instrument Post Lights | 56 | MS25237-327 |
| *Annunciator Panel Lights | 72 | MS25237-327 |
| *Annunciator Panel Master Warning Lights | 8 | MS25237-327 |
| *Ignition Lights | 2 | MS25237-327 |
| *Marker Beacon Lights | 3 | CM7235 |
| *Autopilot Off Light | 1 | CM6839 |
| *Altitude Alert Light | 1 | CM6839 |
| *R NAV Number 2 Light | 2 | CM6839 |
| *Autopilot Coupled Light | 1 | CM6839 |
| *IFCS Annunciator Lights | 6 | MS25237-327 |
| *Flight Director GA Light | 1 | CM6839 |
| *Flight Director DH Light | 1 | CM6839 |
| *Radio Altimeter DH Light | 1 | CM6839 |
| *Pilot's and Copilot's Oxygen Outlet, Headphone and Mike Jack Port Light | 2 | MS25237-327 |
| Flap Position Indicator Lights | 4 | MS90451-6832 |
| Map Lights (Overhead Console) | 2 | 1309 |
| Instrument Panel Flood Light | 2 | 1309 |
| Passenger Reading Lights | 8 | 1495 |
| Cabin Doorway Flood Light | 1 | MS15570-303 |
| Engine Fire Warning Light | 8 | MS25237-327 |
| Fire Bottle Armed Light | 4 | MS25237-327 |
| IFCS Mode Selector Lights | 9 or 18 | LS247 |
| Nose Baggage Compartment Light | 1 | 72 |
| Refreshment Bar Light Assembly | 1 | 1400-003 |
| Hot Cup Indicator Light | 1 | 3060D3-48PSB |

**Figure 8-5
LIGHT BULB REPLACEMENT GUIDE**

Landing Gear Position Lights (MS25237-327)

To remove a landing gear position light bulb, press in on the face of the light assembly and allow it to pop out. Grasp the module and pull it from the panel. Lift bulb out of socket and replace with new bulb by reversing the removal procedure. Bulb replacement shown is typical for all landing gear position light bulbs.

MODULE



BULB



5784P6005
5714P6046

Figure 8-6
LANDING GEAR POSITION LIGHTS (TYPICAL)

Compass Light (MS25237-327)

To expose the compass light bulb, swing the bulb shield up. Pull bulb out and replace with new bulb by reversing the removal procedures.

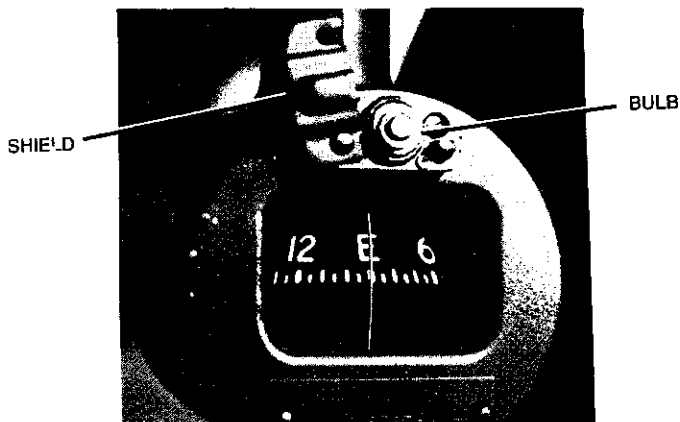
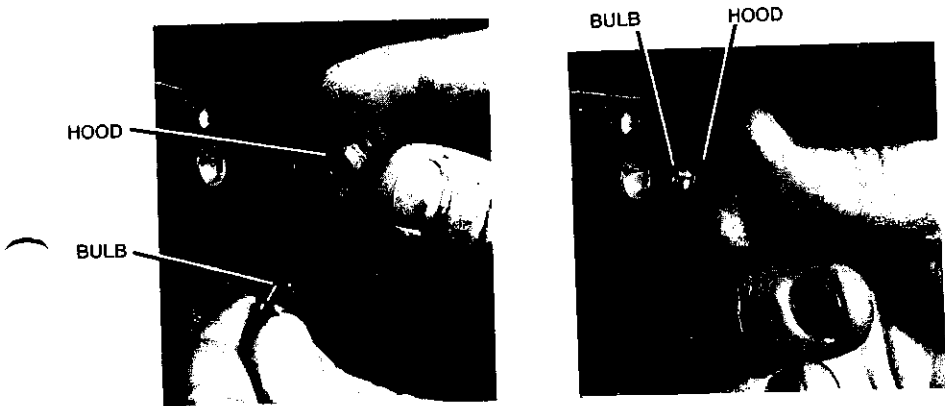


Figure 8-7
COMPASS LIGHT

5914P6046

Instrument Post Lights (MS25237-327)

To remove a post light bulb, pull the hood from the light assembly. Pull the bulb from hood and replace. Press hood firmly into place.

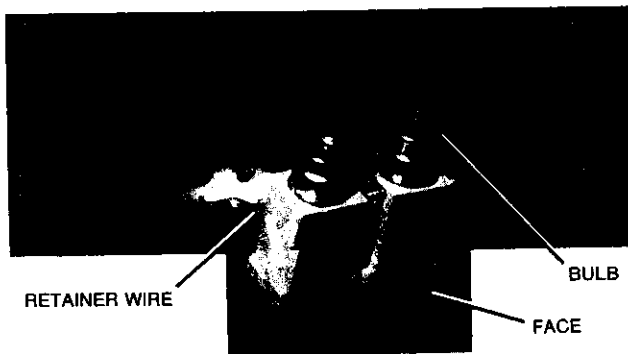


**Figure 8-8
INSTRUMENT POST LIGHTS (TYPICAL)**

1414P6039
1414P6038

Annunciator Panel Lights (MS25237-327)

To replace an annunciator panel light bulb, push in on the face of the light assembly and allow the light to pop out. Pull the module out and allow it to rotate 90 degrees down. A retainer wire will keep the assembly suspended in the position shown, refer to Figure 8-7. Lift the bulb out of the module and insert a new bulb. Rotate the module in position and press into place.



**Figure 8-9
ANNUNCIATOR PANEL LIGHTS (TYPICAL)**

5714P6049

Ignition Lights (MS25237-327)

To replace the left or right ignition light bulb, unscrew the light lens assembly and remove from panel. Pull bulb from lens and replace screw lens assembly back into panel.

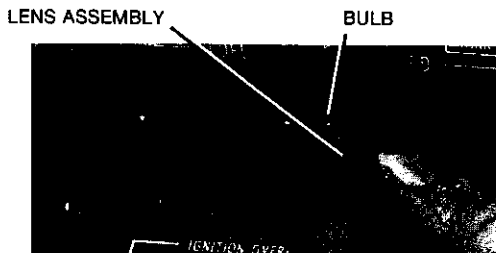


Figure 8-10
IGNITION LIGHTS

5714P6050

Marker Beacon Lights (CM7235), Autopilot Off Light (CM6839) and Altitude Alert Light (CM6839)

To replace bulb, unscrew light lens assembly and remove from panel. Pull bulb from lens housing and replace. Screw lens assembly back into panel socket.

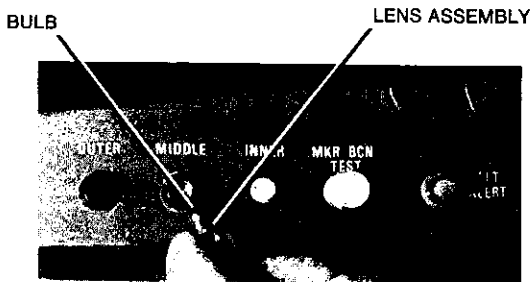


Figure 8-11
MARKER BEACON, AUTOPILOT OFF
AND ALTITUDE ALERT LIGHTS (TYPICAL)

1414P6041

FUSE AND FUSE LIMITER REPLACEMENT

The following table, refer to Figure 8-12, is a fuse and fuse limiter replacement guide. All fuses can be readily changed by the pilot.

| CIRCUIT | FUSE SILKSCREEN | FUSE QUANTITY PER AIRPLANE | FUSE/FUSE LIMITER PART NUMBER |
|--|------------------|----------------------------|-------------------------------|
| STARTER RELAY BOX (Located on left side at FS 190.90 under floor between seats number 1 and 3). | | | |
| RH BUS VOLTAGE SENSING | R GCU GEN | 1 | AGC5 |
| RH GENERATOR VOLTAGE SENSING | R GCU GEN. | 1 | AGC5 |
| LH BUS VOLTAGE SENSING | L GCU BUS | 1 | AGC5 |
| LH GENERATOR VOLTAGE SENSING | L GCU GEN. | 1 | AGC5 |
| BATTERY AMMETER | BATT. SHUNT (-) | 1 | AGC5 |
| BATTERY AMMETER | BATT. SHUNT (+) | 1 | AGC5 |
| RH AMMETER | R GEN. SHUNT (-) | 1 | AGC5 |
| RH AMMETER | R GEN. SHUNT (+) | 1 | AGC5 |
| LH AMMETER | L GEN. SHUNT (-) | 1 | AGC5 |
| LH AMMETER | L GEN. SHUNT (+) | 1 | AGC5 |
| RH DC POWER CONTROL | R GEN CONTROL | 1 | AGC15 |
| LH DC POWER CONTROL | L GEN CONTROL | 1 | AGC15 |
| RH STARTER WARNING LIGHT | START WARN. RH | 1 | AGC5 |
| LH STARTER WARNING LIGHT | START WARN. LH | 1 | AGC5 |
| SURFACE DEICE | SURFACE DEICE | 1 | MDL10 |
| RH MAIN BUS | RH LINE | 1 | ANL250 |
| RH MAIN BUS | RH F.L. | 1 | ANL275 |
| LH MAIN BUS | LH LINE | 1 | ANL250 |
| LH MAIN BUS | LH F.L. | 1 | ANL275 |
| AIR CONDITIONING | AIR COND. | 1 | ANL100 |

**Figure 8-12 (Sheet 1 of 2)
FUSE AND FUSE LIMITER REPLACEMENT GUIDE**

| CIRCUIT | FUSE SILKSCREEN | FUSE QUANTITY PER AIRPLANE | FUSE/FUSE LIMITER PART NUMBER |
|---|-----------------|----------------------------|-------------------------------|
| WINDSHIELD HEAT CONTROLLER | | 1 | AGC5 |
| EMERGENCY BUS FUSES | | | |
| BATTERY RELAY SHELF Located at FS 75.00, right baggage compartment, under floor) | | | |
| CABIN LIGHTS | CABIN LIGHTS | 1 | AGC5 |
| AVIONICS AND CABIN CLOCK | AVIONICS | 1 | AGC5 |
| BATTERY RELAY (SPARE) | BATT RELAY | 1 | AGC5 |
| CABIN LIGHTS POWER (Inside left console on bus) | | 1 | MDL10 |
| TIMED COURTESY LIGHT (Inside left console) | | 1 | AGC2 |
| SPARE FUSE BAG (Under battery door in nose section) | | * | |
| VARIOUS APPLICATIONS | | 11 | AGC5 |
| TIMED COURTESY LIGHT | | 1 | AGC2 |
| DC POWER CONTROL | | 1 | AGC15 |
| CABIN LIGHTS | | 1 | MDL10 |
| AIR CONDITIONING | | 1 | ANL100 |
| MAIN BUS | | 1 | ANL250 |
| MAIN BUS | | 1 | ANL275 |
| *Quantity varies depending on optional equipment installed. | | | |

Figure 8-12 (Sheet 2 of 2)
FUSE AND FUSE LIMITER REPLACEMENT GUIDE

CLEANING AND CARE

EXTERIOR CLEANING

Painted Surfaces

The painted exterior surfaces of your new airplane require an initial curing period which may be as long as 90 days after the finish is applied. During this curing period some precautions should be taken to avoid damaging the finish or interfering with the curing process. The finish should be cleaned only by washing with clean water and mild soap, followed by a rinse water and drying with cloths or a chamois. Do not use polish or wax, which would exclude air from the surface, during this 90-day curing period. Do not rub or buff the finish and avoid flying through rain, hail or sleet.

To help prevent development of corrosion, particularly filiform corrosion, the airplane should be spray washed at least every two or three weeks (especially in warm, damp and salty environments), and waxed with a good grade of water repellant wax to help keep water from accumulating in skin joints and around countersinks. A heavier coating of wax on the leading edges of the wing and tail (on airplanes without deice boots) and on the engine nose cap and propeller spinner, will help reduce abrasions encountered in these areas.

Propeller

Preflight inspection of propeller blades for nicks and wiping them occasionally with an oily cloth to clean off grass and bug stains will assure long, trouble-free service. It is vital that small nicks on the propeller, particularly near the tips and on the leading edges, are dressed out as soon as possible since these nicks produce stress concentrations, and if ignored, may result in cracks. Never use an alkaline cleaner on the blades; remove grease and dirt with Stoddard solvent.

Landing Gear

Cessna Service Facility mechanics have been trained in the proper adjustment and rigging of the landing gear system. To assure trouble-free gear operation, have your Cessna Service Facility check the gear regularly and make any necessary adjustment. Only properly trained mechanics should attempt to repair or adjust the landing gear components and system.

Deice Boots

The deice boots have a special, electrically conductive coating to bleed-off static charges which cause radio interference and may perforate the boots. Fueling and other servicing operations should be done carefully, to avoid damaging this conductive coating or tearing the boots.

To prolong the life of surface and propeller deice boots, they should be washed and serviced on a regular basis. Keep the boots clean and free from oil, grease and other solvents which cause rubber to swell and deteriorate. Outlined below are recommended cleaning and servicing procedures.

CAUTION

USE ONLY THE FOLLOWING INSTRUCTIONS WHEN CLEANING BOOTS. DISREGARD INSTRUCTIONS WHICH RECOMMEND PETROLEUM BASE LIQUIDS (NONLEADED GASOLINE, METHYL-ETHYL-KETONE, ETC.) WHICH CAN HARM THE BOOT MATERIAL.

Clean the boots with mild soap and water, then rinse thoroughly with clean water.

NOTE

- *Temperature of water for cleaning deice boots shall not exceed 140 degrees Fahrenheit.*
- *Isopropyl alcohol can be used to remove grime which cannot be removed using soap. If isopropyl alcohol is used for cleaning, wash area with mild soap and water, then rinse thoroughly with clean water.*

To possibly improve the service life of deice boots and to reduce the adhesion of ice, it is recommended that the deice boots be treated with AGE MASTER Number 1 and ICEX.

AGE MASTER Number 1, used to protect the rubber against deterioration from ozone, sunlight, weathering, oxidation and pollution, and ICEX, used to help retard ice adhesion and for keeping deice boots looking new longer, are both products of and recommended by B. F. Goodrich.

The application of both AGE MASTER Number 1 and ICEX should be in accordance with the manufacturer's recommended directions as outlined on the containers.

CAUTION

- *PROTECT ADJACENT AREAS, CLOTHING, AND USE PLASTIC OR RUBBER GLOVES DURING APPLICATIONS, AS AGE MASTER NUMBER 1 STAINS AND ICEX CONTAINS SILICONE WHICH MAKES PAINT TOUCHUP ALMOST IMPOSSIBLE.*
- *ENSURE THAT THE MANUFACTURER'S WARNINGS AND CAUTIONS ARE ADHERED TO WHEN USING AGE MASTER NUMBER 1 AND ICEX.*

If a high gloss finish is desired on the deice boots, ACROSEAL coating (available from Huber Janitorial Supplies, 114 North St. Francis Street, Wichita, KS 67202) may be used in lieu of AGE MASTER Number 1 and/or ICEX. Preparation for application of ACROSEAL is the same as required for AGE MASTER Number 1 and ICEX. Apply a thin layer of ACROSEAL on the clean and dry surface of the deice boot with a cloth swab. Let dry thoroughly and hand buff with a soft cloth.

Small tears and abrasions in surface deice boots can be repaired temporarily without removing the boots and the conductive coating can be renewed. Your Cessna Service Station has the proper materials and know how to do this correctly.

Engines

The engine compartments should be cleaned, using a suitable solvent. Most efficient cleaning is done using a spray-type cleaner. Before spray cleaning, ensure protection is afforded for components which might be adversely affected by the solvent. Refer to the Airplane Maintenance Manual for proper lubrication of controls and components after engine cleaning.

INTERIOR CLEANING

To remove dust and loose dirt from the upholstery, headliner and carpet, clean the interior regularly with a vacuum cleaner.

Blot up any spilled liquid promptly with cleansing tissue or rags. Don't pat the spot; press the blotting material firmly and hold it for several seconds. Continue blotting until no more liquid is taken up. Scrape off sticky materials with a dull knife, then spot-clean the area.

Oily spots may be cleaned with household spot removers, used sparingly. Before using any solvent, read the instructions on the container and test it on an obscure place on the fabric to be cleaned. Never saturate the fabric with a volatile solvent; it may damage the padding and backing materials.

WARNING

●USE ALL CLEANING AGENTS IN ACCORDANCE WITH THE MANUFACTURER'S RECOMMENDATIONS.

●THE USE OF TOXIC OR INFLAMMABLE CLEANING AGENTS IS DISCOURAGED. IF THESE CLEANING AGENTS ARE USED, ENSURE ADEQUATE VENTILATION IS PROVIDED TO PREVENT HARM TO THE USER AND/OR DAMAGE TO THE AIRPLANE.

Soiled upholstery and carpet may be cleaned with foam-type detergent, used according to the manufacturer's instructions. To minimize wetting the fabric, keep the foam as dry as possible and remove it with a vacuum cleaner.

The plastic trim, instrument panel and control knobs need only be wiped with a damp cloth. Oil and grease on the control wheel and control knobs can be removed with a cloth moistened with kerosene. Volatile solvents, such as mentioned in paragraphs on care of the windshield, must never be used since they soften and craze the acrylic.

Windows and Windshields

The cabin windows and windshield panels are constructed of prestretched or cast acrylic. The surface hardness of acrylic is approximately equal to that of copper or brass.

Care must be exercised to avoid scratches and gouges which may be caused by dirty, hard or rough cloth used for cleaning. Do not use a canvas cover on the acrylic windshield unless freezing rain or sleet is anticipated. Canvas covers may scratch the acrylic surface.

WINDSHIELD AND WINDOW MAINTENANCE PROCEDURES

The following procedures provide the most current information regarding cleaning and servicing windshield and windows. Improper cleaning, or use of unapproved cleaning agents can cause damage to the windows.

MATERIAL REQUIRED

| MATERIAL | MANUFACTURER | USE |
|---|---|---|
| Mild soap or detergent (hand dishwashing type with abrasives) | Commercially available | Cleaning windshields and windows. |
| Aliphatic naphtha Type II conforming to Federal Specification TT-N-95 | Commercially available | Removing deposits which cannot be removed with mild soap solution on acrylic windshields and windows. |
| Polishing wax: (Refer to Note) | | Waxing acrylic windshields and windows. |
| Turtle Wax (paste) | Turtle Wax, Inc. Chicago, IL 60638 | |
| Great Reflections Paste Wax | E.I. du Pont de Nemours and Co. (Inc) Wilmington, DE 19889 | |
| Slip-stream Wax (paste) | Classic Chemical Grand Prairie, TX 75050 | |
| Acrylic Polish conforming to Federal Specification P-P-560 such as: | | Cleaning and polishing acrylic windshields and windows. |
| Permatex plastic cleaner Number 403D | Permatex Company, Inc. Kansas City, KS 66115 | |
| Soft cloth, such as: | Commercially available | Applying and removing wax and polish. |
| Cotton flannel or cotton terry cloth material | | |

NOTE

These are the only polishing waxes tested and approved for use by Cessna Aircraft Company.

CLEANING INSTRUCTIONS



WINDSHIELDS AND WINDOWS ARE EASILY DAMAGED BY IMPROPER HANDLING AND CLEANING TECHNIQUES.

1. Place airplane inside hangar or in shaded area and allow to cool from heat of sun's direct rays.

2. Using clean (preferably running) water, flood the surface. Use bare hands with no jewelry to feel and dislodge any dirt or abrasive materials.
3. Using a mild soap or detergent (such as a dishwashing liquid) in water, wash the surface. Again use only the bare hand to provide rubbing force. (A clean cloth may be used to transfer the soap solution to the surface, but extreme care must be exercised to prevent scratching the surface.)
4. If soils which cannot be removed by a mild detergent remain, Type II aliphatic naphtha applied with a soft clean cloth may be used as a cleaning solvent. Be sure to frequently refold the cloth to avoid redepositing soil and/or scratching windshield with any abrasive particles.
5. Rinse surface thoroughly with clean fresh water and dry with a clean cloth.

CAUTION

DO NOT USE ANY OF THE FOLLOWING ON OR FOR CLEANING WINDSHIELDS AND WINDOWS: METHANOL, DENATURED ALCOHOL, GASOLINE, BENZENE, XYLENE, MEK, ACETONE, CARBON TETRACHLORIDE, LACQUER THINNER, COMMERCIAL OR HOUSEHOLD WINDOW CLEANING SPRAYS. WHEN IN DOUBT, DO NOT USE IT.

6. Hard polishing wax should be applied to acrylic surfaces. (The wax has an index of refraction nearly the same as transparent acrylic and will tend to mask any shallow scratches on the windshield surface.)
7. Acrylic surfaces may be polished using a polish meeting Federal Specifications P-P-560 applied per the manufacturer's instructions.

NOTE

When applying and removing wax and polish, use a clean soft cloth.

WINDSHIELD AND WINDOW PREVENTIVE MAINTENANCE

NOTE

Utilization of the following techniques will help minimize windshield and window crazing.

1. Keep all surfaces of windshields and windows clean.
2. If desired, wax acrylic surfaces.
3. Do not park or store airplane where it might be subjected to direct contact with or vapors from: methanol, denatured alcohol, gasoline, benzene, xylene, MEK, acetone, carbon tetrachloride, lacquer thinners, commercial or household window cleaning sprays, paint strippers, or other types of solvents.
4. Do not use solar screens or shields installed on inside of airplane or leave sun visors up against windshield. The reflected heat from these items causes elevated temperatures which accelerate crazing and may cause formation of bubbles in the inner ply of multiple ply windshields.

Oxygen Masks

The pilot and copilot masks are a permanent-type mask which contains a microphone for radio transmissions.

Passenger masks are regulated, continuous-flow, dilution type masks which do not contain a microphone. All masks can be cleaned with alcohol. Additional masks and hoses are available from your Cessna Service Station.

PROLONGED OUT-OF-SERVICE CARE

Prolonged out-of-service care applies to all airplanes which will not be flown for an indefinite period (less than 60 days) but which are to be kept ready to fly with the least possible preparation. If the airplane is to be stored temporarily, or indefinitely, refer to the Airplane Maintenance Manual for proper storage procedures. The Airplane Maintenance Manual provides amplification for the following procedures:

1. The procedure to be followed for preservation of engines in service depends on the period of inactivity and whether or not the engine may be rotated during the inactive period. The expected period of inactivity should be established and reference made to the Engine Preservation Schedule. The preservation carried out should be recorded in the engine maintenance record and on tags secured to the engine.

The following engine preservation schedule lists procedures to be followed:



UNDER NO CIRCUMSTANCES SHOULD PRESERVATIVE OIL BE SPRAYED INTO THE COMPRESSOR OR EXHAUST PORTS OF THE ENGINE. DIRT PARTICLES DEPOSITED ON BLADES AND VANES DURING ENGINE OPERATION WILL ADHERE AND ALTER THE AIRFOIL SHAPE, ADVERSELY AFFECTING COMPRESSOR EFFICIENCY.

- a. 0 to 7 days - Engine may be left in an inactive state, with no preservation protection, provided: engine is sheltered; humidity is not excessively high; engine is not subjected to extreme temperature changes that would produce condensation.
 - b. 8 to 28 days - Engines inactive for up to 28 days require no preservation provided all engine openings are sealed off and relative humidity in engine is maintained at less than 40 percent. Humidity control is maintained by placing desiccant bags and humidity indicator on wooden racks in engine exhaust duct. Suitable windows must be provided in exhaust closure to facilitate observation of humidity indicators.
 - c. 29 to 90 days - Engines inactive for a period exceeding 28 days, but less than 90 days, need only have fuel system preserved, engine intake and exhaust openings covered, and desiccant bags and humidity indicators installed.
 - d. 91 days and over - Engines inactive over 90 days in airframe or removed for long term storage in container, must, in addition to the 29 to 90 day procedure, have engine oil drained and unused accessory drive pads sprayed.
2. Place a contrasting colored plastic tape over static ports. Install all protective covers and cover all fuselage air inlets to prevent entry of foreign objects.
 3. Keep the fuel tanks full to minimize condensation in the fuel tanks.
 4. If the airplane will be out of service for 5 days or more, disconnect battery and as necessary, clean and coat the intercell hardware with a light coat of neutral nonconductive grease, such as petroleum jelly, to prevent corrosion. Battery must be maintained in accordance with Marathon Battery Instruction Manual, BA-89.
 5. If the airplane is stored outside, tie-down airplane in accordance with the tie-down procedures in this section.

6. Check the main landing gear tires; do not set the parking brake if a long period of inactivity is anticipated as brake seizing can result.
7. Every two weeks move airplane to prevent flat areas on tires. Mark tires with tape to ensure tire is placed approximately 90 degrees from previous position.
8. Drain all fuel drain points every 30 days and check for water accumulation. Prolonged storage of the airplane will result in a water buildup in the fuel which "leaches out" the ethylene glycol monomethyl ether (EGME) fuel additive. An indication of this is when an excessive amount of water accumulates in the fuel tank sumps. Refer to Fuel Additive in this section for minimum allowable EGME concentrations.

)

)

SECTION 9
SUPPLEMENTS

TABLE OF CONTENTS

INTRODUCTION 9-4

SUPPLEMENTS - GENERAL

1 ALCOHOL WINDSHIELD DEICE SYSTEM 2 Pages
 (NOT USED) 1 Page

3 DIGITAL CLOCK DAVTRON 3 Pages

4 DEICE BOOT SYSTEM 5 Pages

5 FLIGHT IN ICING CONDITIONS 7 Pages

6 RECOGNITION LIGHTS 1 Page

7 OSCILLATING BEACON GROUND
 RECOGNITION LIGHTS 1 Page

8 AIR CONDITIONING SYSTEM 3 Pages

9 ELECTRICAL WINDSHIELD ANTI-ICE SYSTEM .. 2 Pages

SUPPLEMENTS - AVIONICS

10 800 ALTITUDE ENCODING/ALERTING
 /PRESELECT (EA-801A) 7 Pages

11 400 ENCODING ALTIMETER (EA-401A) 3 Pages

12 400 AREA NAVIGATION SYSTEM (RN-479A) 10 Pages

13 400 DME (R-477A) 4 Pages

14 FLIGHT CONTROL SYSTEM (AF-1050A) 20 Pages

15 HORIZONTAL SITUATION INDICATOR (CS-832B) . 3 Pages

16 1000 INTEGRATED FLIGHT CONTROL
 SYSTEM (IF-1050A) 25 Pages

17 NAVIGATION SYSTEM (PN-101) 4 Pages

18 RADIO ALTIMETER SYSTEM (AA-100) 3 Pages

19 RADIO MAGNETIC INDICATOR (7100RMI) 3 Pages

20 1000 RADIO MAGNETIC INDICATOR (IN-1004A/B) . 4 Pages

21 TRANSCEIVER (HF-220) 4 Pages

22 400 TRANSPONDER (459A) 4 Pages

23 WEATHER RADAR (RDR-160) 4 Pages

24 WEATHER RADAR COLOR
 DISPLAY (RDR-160XD) 6 Pages

TABLE OF CONTENTS (CONTINUED)

25 KING AREA NAVIGATION SYSTEM (KNS-81) . . . 11 Pages
26 KING AUDIO CONTROL PANEL (KMA-24H-70) . . . 5 Pages
27 KING DIGITAL ADF (KR-87) 8 Pages
28 KING DIGITAL COMM (KY-196) 8 Pages
29 KING DME (KN-63) 4 Pages
30 KING HF TRANSCEIVER (KHF-950) 9 Pages
31 KING MARKER BEACON (KR-21) 4 Pages
32 KING RADAR ALTIMETER (KRA-10A) 4 Pages
33 KING RADIO MAGNETIC INDICATOR (KI-229) . . . 5 Pages
34 KING RADIO MAGNETIC INDICATOR (KNI-582) . . 5 Pages
35 KING TRANSPONDER (KT-79) 6 Pages
36 NARCO WEATHER RADAR (KWX-56 COLOR) 9 Pages
37 KING DIGITAL NAVIGATION RECEIVER (KN-53) . 5 Pages
38 COLLINS HF COMMUNICATION SYSTEM (HF-230) 9 Pages

L'ingénieur en chef



1988

LOG OF REVISIONS

Supplement pages which have changed since the original issue of this manual are listed below.

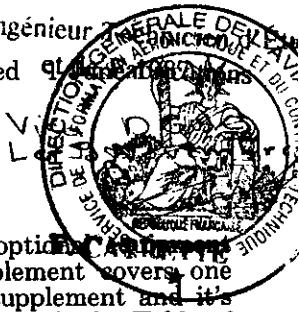
| Supplement Number | Name | Pages Added/ Deleted/Review | Revision Date |
|-------------------|--|--------------------------------|---------------------|
| 2 | Angle-of-Attack System (Supplement Deleted) | 1 of 1 | Revised 1 June 1987 |
| | | 2 of 3 | Deleted 1 June 1987 |
| | | 3 of 3 | Deleted 1 June 1987 |
| 4 | Deice Boot System | 1 of 5 | Revised 1 June 1988 |
| | | 3 of 5 | Revised 1 June 1988 |
| | | 4 of 5 | Revised 1 June 1988 |
| | | 5 of 5 | Revised 1 June 1988 |
| 23 | Weather Radar (RDR-160) | 1 of 4 | Revised 1 June 1987 |
| 24 | Weather Radar Color Display (RDR-160XD) | 2 of 6 | Revised 1 June 1987 |
| 25 | King Area Navigation System (Type KNS-81) | 1 of 11 thru 11 of 11 | Added 1 June 1987 |
| 26 | King Audio Control Panel (Type KMA-24H-70) | 1 of 5 thru 5 of 5 | Added 1 June 1987 |
| 27 | King Digital ADF (Type KR-87) | 1 of 8 thru 8 of 8 | Added 1 June 1987 |
| 28 | King Digital Comm (Type KY-196) | 1 of 8 thru 8 of 8 | Added 1 June 1987 |
| 29 | King DME (Type KN-63) | 1 of 4 thru 4 of 4 | Added 1 June 1987 |
| 30 | King HF Transceiver (Type KHF-950) | 1 of 9 thru 9 of 9 | Added 1 June 1987 |
| 31 | King Marker Beacon (Type KR-21) | 1 of 4 thru 4 of 4 | Added 1 June 1987 |

LOG OF REVISIONS (CONTINUED)

| Supplement Number | Name | Pages Added/ Deleted/Review | Revision Date |
|-------------------|---|--------------------------------|-------------------|
| 32 | King Radar Altimeter (Type KRA-10A) | 1 of 4 thru 4 of 4 | Added 1 June 1987 |
| 33 | King Radio Magnetic Indicator (Type KI-229) | 1 of 5 thru 5 of 5 | Added 1 June 1987 |
| 34 | King Radio Magnetic Indicator (Type KNI-582) | 1 of 5 thru 5 of 5 | Added 1 June 1987 |
| 35 | King Transponder (Type KT-79) | 1 of 6 thru 6 of 6 | Added 1 June 1987 |
| 36 | Narco Weather Radar (Type KWX-56 Color) | 1 of 9 thru 9 of 9 | Added 1 June 1987 |
| 37 | King Digital Navigation Receiver (Type KN-53) | 1 of 5 thru 5 of 5 | Added 1 June 1987 |
| 38 | Collins HF Communication System (Type HF-230) | 1 of 9 thru 9 of 9 | Added 1 June 1987 |

INTRODUCTION

Section 9 provides supplemental information for optional equipment which may be installed on the airplane. Each supplement covers one item of optional equipment. To locate a particular supplement and its corresponding supplement number within Section 9, consult the Table of Contents. The supplements are arranged in numerical sequence with the supplement number located at the bottom of the page above the page number.



ALCOHOL WINDSHIELD DEICE SYSTEM**SECTION 1 - GENERAL**

This supplement provides information which must be observed when operating the alcohol windshield deice system.

Description

The alcohol windshield deice system consists of an alcohol tank, a pump, a dispersal tube for each windshield and a switch breaker.

The alcohol tank, located in the right nose compartment, has a 3.0 gallon capacity. The tank should be filled with isopropyl alcohol only. Water dilution of the alcohol is not recommended, as any water contained in the alcohol will reduce the efficiency of ice removal and may freeze on the windshield at very low temperatures. The pump, located adjacent to the tank, provides positive pressure to each windshield dispersal tube. A dispersal tube, located at the forward base of each windshield, provides flow pattern control throughout the airplane's speed envelope. Each tube contains five holes which should be inspected and cleaned with a small diameter wire as necessary.

Abnormal operation of the alcohol windshield deice system is indicated by the switch breaker tripping to the OFF position or failure of alcohol to flow onto the windshield.

SECTION 2 - LIMITATIONS

1. Discontinue alcohol dispersal 20 seconds before reaching minimum descent altitude.
2. Do not operate system longer than 3 minutes without alcohol flow.

SECTION 3 - EMERGENCY PROCEDURES

Not Applicable.

SECTION 4 - NORMAL PROCEDURES

1. Preflight Inspection
 - a. Windshield Dispersal Tubes - CHECK condition and cleanliness.

- b. Alcohol Tank
Level - CHECK. Full tank provides approximately 1 hour of continuous operation. If alcohol deicing is installed on left or right windshield only, approximately 2 hours of continuous operation is available.
- 2. Before Takeoff
 - a. Alcohol Windshield
Switch - ON. Allow 10 seconds for alcohol flow to begin. Check 5 dispersal holes for flow at the base of each windshield.
 - b. Alcohol Windshield Switch - OFF.
- 3. In Flight
 - a. During Icing Encounters:
 - (1) Alcohol Windshield Switch - ON.

NOTE

For operation in continuous enroute icing conditions, allow approximately 0.125 to 0.25 inch of ice to accumulate. The windshield deice system can be used as an anti-ice system by continuous use and should be so used during the approach to landing. However, the maximum endurance with a 3.0 gallon tank is approximately 1.0 hour of continuous operation. If alcohol deicing is installed on left or right windshield only, approximately 2 hours of continuous operation is available. Airspeed should be 140 KIAS or below for best results.

- (2) Alcohol Windshield Switch - OFF after ice removal.
- 4. Approach to Landing

WARNING

THE WINDSHIELD DEICE SWITCH BREAKER MUST BE POSITIONED OFF 20 SECONDS PRIOR TO REACHING MINIMUM DESCENT ALTITUDE. THE ALCOHOL FILM MUST BE ALLOWED TO EVAPORATE BEFORE A CLEAR FIELD OF VISION THROUGH THE WINDSHIELD IS AVAILABLE.

SECTION 5 - PERFORMANCE

Not Applicable.

SUPPLEMENT 2 DELETED

Remove existing pages 1 of 3, 2 of 3, and 3 of 3.



)

)

DIGITAL CLOCK DAVTRON 811B**SECTION 1 - GENERAL**

This supplement provides information which must be observed when operating the Davtron 811B digital clock.

Description

The Davtron 811B, 24-hour, digital clock, refer to Figure 1, is a solid-state timing device which presents real time, flight time and elapsed time. The clock's internal memory is maintained, regardless of the airplane battery switch position, by a nonchargeable clock battery. This clock battery should be replaced every three years. The clock's light emitting diode (LED) displays require airplane electrical power.

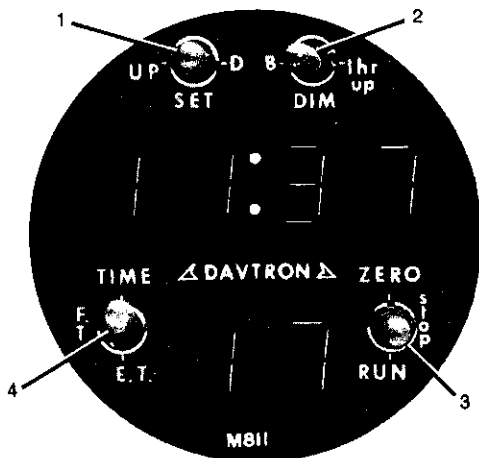
All operating controls (four switches) are provided on the face of the clock.

The SET switch is used to make minor corrections to the real time memory of the clock. This switch should be used only after checking the clock with an accurate time reference such as the National Bureau of Standards time broadcast. If the clock is found to be inaccurate, position the SET switch to UP for the number of seconds the clock is slow or to D for the number of seconds the clock is fast. The flight time and elapsed time functions will operate normally during the setting of the real time function, therefore, the elapsed time display can be used to time the holding of the SET switch.

The DIM switch is used to make one-hour changes to the real time and to set the light intensity for day and night flight operations. If real time changes of hours only are required, each momentary actuation of the DIM switch to the 1 hr position will advance the real time one hour. During daylight operations, the switch should be positioned to B. During night operations, the DIM position will decrease illumination intensity to a desirable level.

The ZERO switch is used to zero, stop or run the elapsed time functions. Actuation of the switch to the ZERO position will zero the elapsed time function. Actuation of the switch to the STOP position will stop the elapsed time function. Actuation of the switch to the RUN position will start the elapsed time function. The ZERO switch is also used to zero the flight time function when the airplane battery switch is OFF and the airplane is on the ground.

The TIME switch is used to display real time, flight time or elapsed time in hours, minutes and seconds in the two display windows. When the switch is positioned to TIME, the real time will be displayed. When the switch is positioned to ET, the elapsed time will be displayed. When the switch is positioned to FT, the flight time will be displayed. The flight time function is wired through the landing gear safety switch; thus, flight time can only be accumulated when the weight of the airplane is off the landing gear.



1014P6057

1. SET SWITCH - Used to correct real time in seconds. UP position advances real time while D position retards real time.
2. DIM SWITCH - Used to set display illumination intensity and to advance real time in one-hour increments.
3. ZERO SWITCH - Used to stop, start and zero the elapsed time function. The flight time function can also be zeroed if the airplane battery switch is OFF and the airplane is on the ground.
4. TIME SWITCH - Used to display real time, flight time or elapsed time functions in hours, minutes and seconds.

Figure 1
DIGITAL CLOCK

SECTION 2 - LIMITATIONS

Not Applicable.

SECTION 3 - EMERGENCY PROCEDURES

Not Applicable.

SECTION 4 - NORMAL PROCEDURES

1. Before Starting The Engines

- a. Zero Switch - ZERO momentarily to zero the elapsed flight time functions.
- b. Dim Switch - AS REQUIRED.

SECTION 5 - PERFORMANCE

Not Applicable.

—

—

DEICE BOOT SYSTEM

SECTION 1 - GENERAL

This supplement provides information which must be observed when operating the deice boot system.

Description

This system is designed to remove ice after accumulation, rather than prevent ice formation.

The deice boot system consists of pneumatic air operated boots, an annunciator light to monitor system operation and necessary hardware to complete the system, refer to Figure 1.

The deice boots are attached to the leading edges of the wing and horizontal and vertical stabilizers. The boots expand and contract, using pressure and vacuum generated by engine bleed air. Normally, vacuum is applied to all of the boots to hold them against the leading edge surfaces.

CAUTION

OPERATION DURING A BLEED AIR SYSTEM OVERPRESSURE CONDITION CAN RESULT IN PERMANENT DAMAGE TO THE DEICE BOOTS. REFER TO SECTION 7, FLIGHT INSTRUMENTS DESCRIPTION, FOR INFORMATION CONCERNING BLEED AIR SYSTEM OVERPRESSURE.

When the surface deice switch is positioned to AUTO, a deice boot cycle is initiated, the vacuum is removed and bleed air pressure is applied to inflate the boots. This change in contour will break the ice accumulation on the leading edges. Ice formation aft of this area will then be removed by normal inflight air forces. A normal boot inflation sequence is 6 seconds for empennage boots followed by 6 seconds for the wing boots. The system should be cycled when ice accumulates to between 1/4 and 1/2 inch. In the event of a malfunction in the timer, causing erratic operation of a sequence of a cycle, the surface deice switch can be held in MANUAL position to achieve simultaneous inflation of all the deice boots. If necessary, the system can be stopped at any point in the cycle to deflate the boots by pulling the DEICE circuit breaker.

A light on the annunciator panel, marked SURFACE DEICE, will illuminate when the tail boots become inflated to a pressure of 15 pounds per square inch or more. If less than 15 pounds per square inch

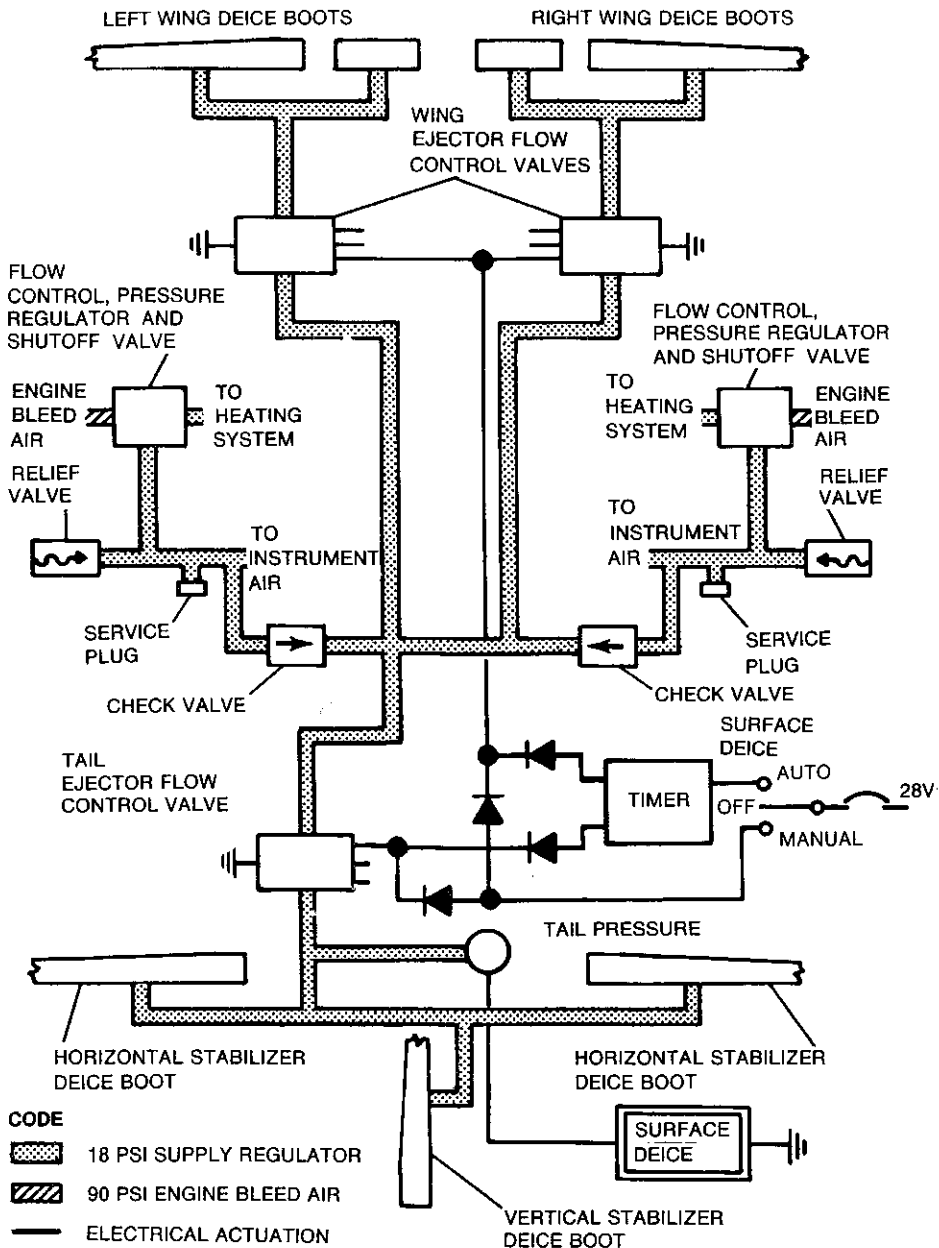


Figure 1
DEICE BOOT SYSTEM SCHEMATIC

is available, the light will not illuminate, indicating that icing conditions should be avoided. Prior to flight in icing conditions, operation of the boots should be functionally checked on the ground with power above 400 foot-pounds or in flight with the OAT above -40 degrees Celsius.



OPERATION BELOW -40 DEGREES CELSIUS CAN RESULT IN PERMANENT DAMAGE TO THE DEICE BOOTS.

SECTION 2 - LIMITATIONS

Not Applicable.

SECTION 3 - EMERGENCY PROCEDURES

1. Surface Deice Failure (one or more deice boots fail to inflate).
 - a. SURFACE DEICE Circuit Breaker - RESET.
 - b. Surface Deice Switch - OFF then AUTO.
 - c. If Deice Boots Fail to Inflate:
 - (1) Surface Deice Switch - MANUAL. Hold approximately 9 seconds.
 - (2) Surface Deice Boots - VISUALLY OBSERVE simultaneous inflation of all deice boots.
 - (3) Surface Deice Annunciator - CHECK. (Should illuminate within 6 seconds after actuating the surface deice switch to MANUAL).
 - d. If normal operation does not occur, leave icing conditions as soon as possible.

If Surface Deice Annunciator Fails to Illuminate or Ice Remains on the Horizontal Stabilizer Surface:

- a. Wing Flaps - UP. (Do not extend the wing flaps with ice build-up on the horizontal stabilizer.)
 - b. Coordinated Flight - MAINTAIN.
 - c. Airspeed - 180 KIAS Maximum.
 - d. Landing - Wing Flaps UP; Refer to LANDING WITH WING FLAPS RETRACTED Procedures.
2. Surface Deice Failure (one or more deice boots fail to deflate).
 - a. SURFACE DEICE Circuit Breaker - RESET.

- b. Surface Deice Switch - OFF then AUTO.

If Surface Deice Boots Remain Inflated:

- a. SURFACE DEICE Circuit Breaker - PULL.
- b. Leave icing conditions as soon as possible.

If Surface Deice Boots Remain Inflated On Approach:

- a. Approach - Increase approach speed by 10 KIAS.

SECTION 4 - NORMAL PROCEDURES

- 1. Preflight Inspection.
 - a. Deice Boots - CHECK for tears, abrasions and cleanliness.
- 2. Before Takeoff.
 - a. Surface Deice Boot Test.
 - (1) Power - INCREASE to 400 foot-pounds.
 - (2) Surface Deice Switch - AUTO. Visually check operation of boots and annunciator light ON.

NOTE

Positioning the surface deice switch to AUTO will result in one complete inflation and deflation cycle lasting approximately 30 seconds.

- 3. Inflight.
 - a. During Icing Encounters.
 - (1) Surface Deice Switch - AUTO when ice accumulates between 1/4 to 1/2 inch. Repeat as necessary, allowing at least 30 seconds between actuations.

NOTE

Accumulation of a 1/2 inch of ice can cause a cruise speed reduction of up to 30 knots as well as a significant buffet and stall speed increase. Increase power as required to maintain desired airspeed.

- b. Leave icing conditions as soon as possible if airplane is not equipped for flight in icing conditions.

NOTE

Since wing, horizontal stabilizer and vertical stabilizer deice boots alone do not provide adequate protection for the entire airplane, icing conditions should be avoided whenever possible unless the airplane is equipped for flight in icing conditions. Refer to Flight In Icing Conditions supplement for details. If icing is encountered, close attention should be given to the pitot-static system, propellers, induction systems and other components subject to icing.

WARNING

IF ONE ENGINE INOPERATIVE APPROACH IS REQUIRED, A GO AROUND WITH ICE ACCUMULATION MAY NOT BE POSSIBLE.

4. After Landing.
 - a. Ice Protection Equipment - OFF.

SECTION 5 - PERFORMANCE

1. When climbing through areas of light to moderate icing conditions, use best rate-of-climb airspeeds and higher engine power settings to preclude ice buildup on the fuselage undersurface and lower wing surfaces.
2. During prolonged icing encounters, increase engine power to maintain desired airspeed as ice accumulates on the unprotected areas and preclude ice buildup on the fuselage undersurface and lower wing surfaces.
3. Prestall buffet and stall speeds increase approximately 5 knots when deice boots are actuated. Maintain extra speed, especially during an approach, before actuating the boots.
4. Maintain extra airspeed on approach to compensate for the increased prestall buffet associated with ice on the unprotected areas and the increased weight. Maintaining extra airspeed on approach will increase the landing distance.
5. Airplane general performance is decreased with ice on the unprotected areas.
6. Climb performance decreases with ice accumulation and the use of inertial separators in the bypass mode. Subtract 300 feet per minute from the RATE-OF-CLIMB - BALKED LANDING CLIMB performance in Section 5. Subtract 200 feet per minute from the RATE-OF-CLIMB - ONE ENGINE INOPERATIVE performance in Section 5.

(

(

FLIGHT IN ICING CONDITIONS**SECTION 1 - GENERAL**

This supplement provides information which must be observed when operating the ice protection equipment for flight in icing conditions.

Description

An icing equipment package (Cessna Drawing 6015006, Factory Kit Number 194) is available which allows flight in icing conditions as defined by the FAA. The package consists of the following: Fuselage ice protection plates; Inboard and outboard wing, horizontal stabilizer and vertical fin deice boots; Electrical anti-ice windshield (pilot's side only); Ice detection lights (left and right). The following items used with flight in icing conditions are required equipment on standard airplanes and are not included in the icing equipment package: propeller deice boots; heated pitot tube(s); heated stall warning vane; heated static vent ports; engine inertial separators.

The wing and empennage deice boots are designed to remove ice after it has formed rather than prevent its formation. The propeller deice boots will also remove accumulated ice; however, they should be activated prior to entering icing conditions. The remainder of the equipment is designed to prevent ice accumulation and should be activated prior to entering icing conditions.

SECTION 2 - LIMITATIONS**KINDS OF OPERATIONAL EQUIPMENT LIMITS****FLIGHT IN ICING CONDITIONS:**

1. All Equipment Required for DAY VFR and IFR.
2. All Equipment Required for NIGHT VFR and IFR (If a Night Flight).
3. Annunciators (Lights)
 - a. Surface Deice
 - b. Electric Windshield Anti-Ice
4. Miscellaneous Indicators
 - a. Propeller Deice Ammeter (2)
5. Systems
 - a. Inboard and Outboard Wing, Horizontal Stabilizer and Vertical Fin Deice Boots
 - b. Electrical Anti-Ice Heated Windshield (Pilot's Side Only)
 - c. Ice Detection Light (2)

- d. Propeller Deice
- e. Heated Pitot Tube (2)
- f. Heated Static Vent Port (2)
- g. Heated Stall Warning Vane

If the pilot's windshield is covered with ice, do not leave the electrical windshield anti-ice switch on for more than 20 seconds. Operation in excess of 20 seconds will cause an overheat condition which can result in failure of the windshield heating element and/or permanent distortion of the windshield.

SECTION 3 - EMERGENCY PROCEDURES

Propeller Deice System Failure

If uneven deicing of propeller blades is indicated by excessive vibration:

1. Propellers - EXERCISE to MAX RPM.
2. Propellers Ammeter - CHECK for proper operation by periodic fluctuations within the green arc.
3. If ammeter reading for either propeller is below the green arc, indicating the propeller blades may not be deicing uniformly:
 - a. Propeller Deice Switch - OFF (affected propeller).
4. If vibration continues leave icing conditions as soon as possible.



*DO NOT OPERATE PROPELLER DEICE
FOR PROLONGED PERIODS WHEN PRO-
PELLERS ARE NOT TURNING.*

Engine Inertial Separator Failure

If Inertial Separator Fails to Transition to the Bypass Mode:

1. Affected INERTIAL SEP Circuit Breaker - RESET.
2. Affected Inertial Separator Switch - CYCLE (Normal to Bypass).
3. Affected Engine Torque and ITT Indicator - MONITOR for proper operation by noting torque drop (typically 100 to 150 foot-pounds) and a slight rise in ITT.

If Inertial Separator Remains Inoperative:

1. Ignition Switch - ON.
2. Leave icing conditions as soon as possible.

Surface Deice Failure (one or more deice boots fail to inflate)

1. SURFACE DEICE Circuit Breaker - RESET.
2. Surface Deice Switch - OFF then AUTO.
3. If Deice Boots Fail to Inflate:
 - a. Surface Deice Switch - MANUAL; hold approximately 9 seconds.
 - b. Surface Deice Boots - VISUALLY OBSERVE simultaneous inflation of all deice boots.
 - c. Surface Deice Annunciator - CHECK. (Should illuminate within 6 seconds after actuating the surface deice switch to MANUAL.)
4. If normal operation does not occur, leave icing conditions as soon as possible.

If Surface Deice Annunciator Fails to Illuminate or Ice Remains on the Horizontal Stabilizer Surface:

1. Wing Flaps - UP. (Do not extend the wing flaps with ice build-up on the horizontal stabilizer.)
2. Coordinated Flight - MAINTAIN.
3. Airspeed - 180 KIAS Maximum.
4. Landing - Wing Flaps Up; refer to LANDING WITH WING FLAPS RETRACTED Procedures.

Surface Deice Failure (one or more deice boots fail to deflate)

1. SURFACE DEICE Circuit Breaker - RESET.
2. Surface Deice Switch - OFF then AUTO.

If Surface Deice Boots Remain Inflated:

1. SURFACE DEICE Circuit Breaker - PULL.
2. Leave icing conditions as soon as possible.

If Surface Deice Boots Remain Inflated On Approach:

1. Approach - Increase approach speed by 10 KIAS.

Electric Windshield Anti-Ice Failure

1. ELECT W'SHIELD Circuit Breaker - RESET.
2. Windshield Anti-Ice Switch - RESET.
3. If normal operation does not occur, leave icing conditions as soon as possible.
4. Cabin Air Defrost Knob - PULL.
5. Cabin Temperature Selector - CABIN HEAT AUTO (Maximum clockwise).

If Landing is Required with Ice Obscuring Vision:

1. Approach - Precision approach is recommended or circling to left if precision approach is not available.

NOTE

Final configuration changes should be made as early in the approach as possible.

2. Approach Speed - INCREASE 10 KIAS.
3. Runway Lights - Request maximum bright.
4. Side Slip - Minimum as required to maintain runway in sight. (Do not side slip if deice boots are inoperative.)
5. Power Reduce - Slowly (Depth of vision may be impaired with ice on the windshield).

Heated Pitot/Static System Failure

1. Pitot/Static Switch - OFF then ON.
2. If normal operation does not occur, leave icing conditions as soon as possible.

SECTION 4 - NORMAL PROCEDURES

1. Preflight Inspection.
 - a. Pitot Heat Switch(es) - ON 20 seconds - OFF (Ensure Pitot Covers Are Removed).
 - b. Stall Vane Heat Switch - ON 20 seconds - OFF.
 - c. Deice Boots - CHECK for tears, abrasions and cleanliness.
 - d. Pitot Tube(s) - CLEAR and WARM.
 - e. Static Port(s) - CLEAR and WARM.



DO NOT OPERATE SYSTEM HEATERS FOR PROLONGED PERIODS ON THE GROUND.

NOTE

Stall vane heat switch operates stall vane heater and static port heaters. Pitot heat switch(es) operates pitot tube heater(s).

2. Before Takeoff.
 - a. Surface Deice Boot Test.
 - (1) Power - INCREASE to 400 foot-pounds.
 - (2) Surface Deice Switch - AUTO. Visually check operation of boots and annunciator light ON.

NOTE

Positioning the surface deice switch to AUTO will result in one complete inflation and deflation cycle lasting approximately 30 seconds.

- b. Inertial Separator Switch - BYPASS momentarily. Visually check annunciator lights ON. Turn switches OFF after check.
- c. Propeller Deice Switch - ON momentarily. Check propeller ammeter.

NOTE

Proper operation of propeller deice system is indicated by periodic fluctuations, within the green arc, on the propeller ammeter.

- d. Electrical Windshield
Anti-Ice Switch - ON momentarily. Check ammeter for increased amperage and WINDSHIELD annunciator light for illumination.

NOTE

Turn off windshield anti-ice switch as soon as the ammeter and the annunciator light have been checked.

3. Inflight.

- a. Before visible moisture is encountered with outside air temperature below 4 degrees Celsius (40 degrees Fahrenheit):
 - (1) Pitot Heat Switch(es) - ON.
 - (2) Stall Vane Heat Switch - ON.
 - (3) Inertial Separator - BYPASS.

CAUTION

IF THE ENGINE INERTIAL SEPARATOR IS NOT POSITIONED TO BYPASS, MOISTURE MAY COLLECT UNDER THE ENGINE INLET SCREEN AND FREEZE. SUBSEQUENTLY, THIS ICE MAY SEPARATE AFTER ENCOUNTERING HIGHER OUTSIDE TEMPERATURES WHICH COULD RESULT IN ENGINE DAMAGE.

- (4) Propeller Deice Switch - ON.

NOTE

Energizing the propeller deice early in icing conditions will prevent ice build-up which will be thrown off and can chip the fuselage paint.

- (5) Electrical Windshield Anti-Ice Switch - ON.
- b. During Icing Encounters:
- (1) Surface Deice Switch - AUTO when ice accumulates between 1/4 to 1/2 inch. Repeat as necessary, allowing at least 30 seconds between actuations.

NOTE

Accumulation of a 1/2 inch of ice may cause a cruise speed reduction of up to 30 knots as well as a significant buffet and stall speed increase. Increase power as required to maintain desired airspeed.

WARNING

IF ONE ENGINE INOPERATIVE APPROACH IS REQUIRED, A GO AROUND WITH ICE ACCUMULATION MAY NOT BE POSSIBLE.

4. After Landing.
- a. Ice Protection Equipment - OFF.

SECTION 5 - PERFORMANCE

1. When climbing through areas of light to moderate icing conditions, use best rate-of-climb airspeeds and higher engine power settings to preclude ice build-up on the fuselage undersurface and lower wing surfaces.
2. During prolonged icing encounters, increase engine power to maintain desired airspeed as ice accumulates on the unprotected areas and preclude ice build-up on the fuselage undersurface and lower wing surfaces.
3. Prestall buffet and stall speeds increase approximately 5 knots when deice boots are actuated. Maintain extra speed, especially during an approach, before actuating the boots.
4. Maintain extra airspeed on approach to compensate for the increased prestall buffet associated with ice on the unprotected areas and the increased weight. Maintaining extra airspeed on approach will increase the landing distance.

5. Airplane general performance is decreased with ice on the unprotected areas.
6. Climb performance decreases with ice accumulation and the use of inertial separators in the bypass mode. Subtract 300 feet per minute from the RATE-OF-CLIMB - BALKED LANDING CLIMB performance in Section 5. Subtract 200 feet per minute from the RATE-OF-CLIMB - ONE ENGINE INOPERATIVE performance in Section 5.

)

)

RECOGNITION LIGHTS

SECTION 1 - GENERAL

This supplement provides information which must be observed when operating the recognition lights.

Description

The recognition lights provide supplemental external lighting for increased airplane visibility. These lights can be used to aid air traffic control facilities and other airplanes in locating the airplane in the air.

One light is mounted in the leading edge of each wing tip, just forward of the landing light. A glareshield is installed inboard of the lights to prevent glare into the cockpit.

SECTION 2 - LIMITATIONS

1. Ground Operating Limitations:
 - a. Ground operation of the recognition lights is limited to a maximum period of five minutes. Regardless of time on, the lights must be turned off for a minimum time period of thirty minutes between each usage.
2. Flight Limitations:
 - a. None.

SECTION 3 - EMERGENCY PROCEDURES

Not Applicable.

SECTION 4 - NORMAL PROCEDURES

1. The recognition lights are operated by a switch/circuit breaker located on the pilot's left side console.
 - a. Switch - ON.

NOTE

When airplane is on the ground, observe ground operating limitations.

- b. Switch - OFF.

SECTION 5 - PERFORMANCE

Not Applicable.

—

—

OSCILLATING BEACON GROUND RECOGNITION LIGHTS

SECTION 1 - GENERAL

This supplement provides information which must be observed when operating the ground recognition lights.

Description

The recognition lights provide supplemental external lighting for increased airplane visibility. These lights are used to aid air traffic control facilities and other airplanes in locating the airplane on the ground.

One light is mounted in the vertical fin and the other is mounted in the lower fuselage.

SECTION 2 - LIMITATIONS

Not Applicable.

SECTION 3 - EMERGENCY PROCEDURES

Not Applicable.

SECTION 4 - NORMAL PROCEDURES

1. The recognition lights are operated by a switch/circuit breaker located on pilot's left side console.
 - a. Switch - ON.

NOTE

These beacon lights are not approved as flight anti-collision lights.

- b. Switch-OFF

SECTION 5 - PERFORMANCE

Not Applicable.

—

—

AIR CONDITIONING SYSTEM

SECTION 1 - GENERAL

This supplement provides information which must be observed when operating the air conditioning.

Description

The air conditioning system, consists of an electrically driven compressor-condenser package in the nose, two evaporators and blower assemblies (one in the nose compartment and one in the tailcone) and a control panel located on the lower part of the right instrument panel.

The blowers distribute conditioned air to the cabin area. Each blower motor electrical circuit is protected by its respective circuit breaker. The blowers may be operated as a ventilating system for recirculating cabin air without using the air conditioning system.

The system control panel consists of two switches and a rheostat. The system switch, placarded COOL-OFF-CIRCULATE, controls the mode of operation. The blower switch, placarded HIGH-LOW, controls the blower speed. The blower will operate whenever the system switch is in either the COOL or CIRCULATE mode. The temperature control rheostat, placarded COOLER, controls the temperature of the conditioned air. Clockwise rotation of the temperature control lowers the air temperature.

SECTION 2 - LIMITATIONS



● *TO PREVENT DAMAGE TO THE AIR CONDITIONING COMPRESSOR, DO NOT OPERATE THE AIR CONDITIONING SYSTEM IN "COOL" WHEN THE OUTSIDE AIR TEMPERATURE IS BELOW 20 DEGREES FAHRENHEIT (-6.7 DEGREES CELSIUS).*

● *WHEN THE OUTSIDE AIR TEMPERATURE IS GREATER THAN 20 DEGREES FAHRENHEIT (-6.7 DEGREES CELSIUS), FREON LOSS AND SERVICING INTERVALS MAY BE REDUCED BY PLACING THE AIR CONDITIONING SELECTOR SWITCH IN "COOL" FOR 5 MINUTES EACH WEEK.*

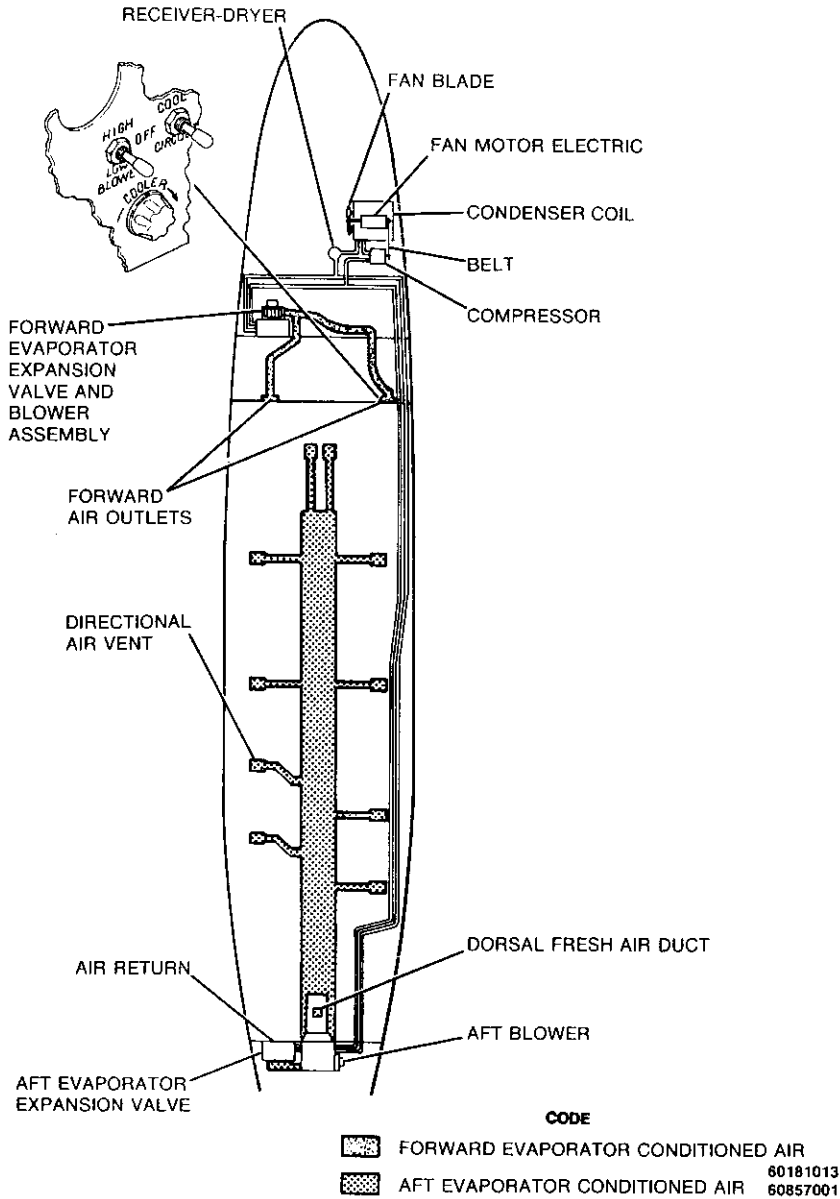


Figure 1
AIR CONDITIONING SCHEMATIC

MODEL 406

SECTION 3 - EMERGENCY PROCEDURES

1. Engine Inoperative Procedures
 - a. Air Conditioner - OFF or CIRCULATE.

SECTION 4 - NORMAL PROCEDURES

NOTE

When engines are not running, an electrical interlock system is utilized to eliminate operation of air conditioner on the ground without auxiliary power unit connected.

1. Starting Procedures
 - a. Air Conditioner - Check OFF.
2. Before Taxi
 - a. Air Conditioner - As Desired.
3. Before Takeoff
 - a. Air Conditioner - OFF or CIRCULATE.
4. After Takeoff
 - a. Air Conditioner - As Desired.
5. Before Landing
 - a. Air Conditioner - OFF or CIRCULATE.
6. After Landing
 - a. Air Conditioner - As Desired

SECTION 5 - PERFORMANCE

Not Applicable

—

—

ELECTRICAL WINDSHIELD ANTI-ICE SYSTEM**SECTION 1 - GENERAL**

This supplement provides information which must be observed when operating the electric windshield.

Description

The electrical windshield anti-ice system consists of an electrically heated element in the pilot's windshield, an inverter, an annunciator light, a heat sensor, a switch and a circuit breaker.

The inverter, located in the right center wing section, supplies AC power to the windshield. The heat sensor cycles the power to the windshield, providing temperature control. The green function indicator light, will illuminate during each heating cycle.

If the indicator does not illuminate periodically, check the bulb by pressing the PRESS-TO-TEST button. A secondary means of checking proper windshield operation can be made by monitoring the voltammeter. When the amp meter selector is positioned to BATT, a change in charge or discharge rate will be noted during each heating cycle.

Abnormal operation of the electrical windshield anti-ice system is indicated by the switch breaker tripping to the OFF position and/or failure of the WINDSHIELD annunciator light to illuminate and/or tripping of the system circuit breaker. Failure of the breaker(s) to stay reset indicates that windshield anti-icing is impossible.

SECTION 2 - LIMITATIONS

If the pilot's windshield is covered with ice, do not leave the electrical windshield anti-ice switch on for more than 20 seconds. Operation in excess of 20 seconds will cause an overheat condition which can result in failure of the windshield heating element and/or permanent distortion of the windshield.

SECTION 3 - EMERGENCY PROCEDURES

1. Electric Windshield Anti-Ice Failure.
 - a. ELECTRIC WSHIELD Circuit Breaker - RESET.
 - b. Windshield Anti-Ice Switch - RESET.
 - c. If normal operation does not occur, leave icing conditions as soon as possible.

SECTION 4 - NORMAL PROCEDURES

1. Before Takeoff

a. Electrical Windshield

Anti-Ice Switch - ON momentarily. Check ammeter for increased amperage and WINDSHIELD annunciator light for illumination.

NOTE

Turn off windshield anti-ice switch as soon as the ammeter and the WINDSHIELD annunciator light have been checked.

2. Inflight

a. Electrical Windshield

Anti-Ice Switch - ON before entering visible moisture with outside air temperature below 4 degrees Celsius (40 degrees Fahrenheit).

b. Leave icing conditions as soon as possible if airplane is not equipped for flight in icing conditions.

NOTE

Since the electrical windshield anti-ice system alone does not provide adequate protection for the entire airplane, icing conditions should be avoided whenever possible unless the airplane is equipped for flight in icing conditions. Refer to Flight In Icing Conditions supplement for details. If icing is encountered, close attention should be given to the pitot-static system, propellers, induction systems, wing and stabilizer leading edges and other components subject to icing.

3. After Landing

a. Electrical Windshield Anti-Ice Switch - OFF.

SECTION 5 - PERFORMANCE

Not Applicable.

**800 ALTITUDE ENCODING/ALERTING/PRESELECT
(EA-801A)****SECTION 1 - GENERAL**

This supplement provides information which must be observed when operating the 800 encoding altimeter.

Description

The 800 encoding altimeter (Type EA-801A) is an electrically driven instrument that senses airplane altitude and provides the pilot with a visual display of the altitude. It also includes an optical encoder which automatically produces a logic code corresponding to the sensed altitude. This code is supplied to the Air Traffic Control Radar Beacon System transponder in the airplane to generate replies to Mode C (altitude reporting) interrogations from the ground controller. A second altitude information output from the altimeter can be coupled to airplane accessory equipment such as an altitude alerter.

The altitude alerter (Type AA-801A) is an accessory unit used with the 800 encoding altimeter to supply a preselected altitude capture signal to arm the altitude hold function of the Autopilot System. It also provides visual and aural warnings when the airplane deviates from the selected altitude.

The encoding altimeter is a panel-mounted barometric altimeter with an altitude range of -1000 to +35,000 feet. Altitude is displayed by a dial and a digital readout. The dial is graduated in 10 numerical divisions which represent increments of 100 feet, with subdivision markings for every 20 feet; the dial pointer completes one revolution for every 1000 feet of altitude change. The digital readout displays airplane altitude in increments of hundreds and thousands of feet only. Friction-induced lag and jumping of the display is reduced by the use of a combined aneroid sensor and motor-driven display. Electronic damping circuits in the unit ensure that the display follows altitude changes rapidly with no overshoot. When power is removed from the altimeter, a striped warning flag appears across the digital altitude display to indicate a "power-off" condition.

Ambient atmospheric pressure is set into the altimeter with a manually operated baroset knob, and is displayed on a four-digit readout, either in inches of mercury or in millibars (as ordered). The pressure setting does not affect the output of the optical encoder, since the encoder is always referenced to standard pressure (sea level; 29.92 inches of mercury or 1013.2 millibars).

Except for introducing the altimeter setting with the baroset knob, operation of the altimeter is completely automatic. The baroset knob and the display indicators are shown in Figure 1.

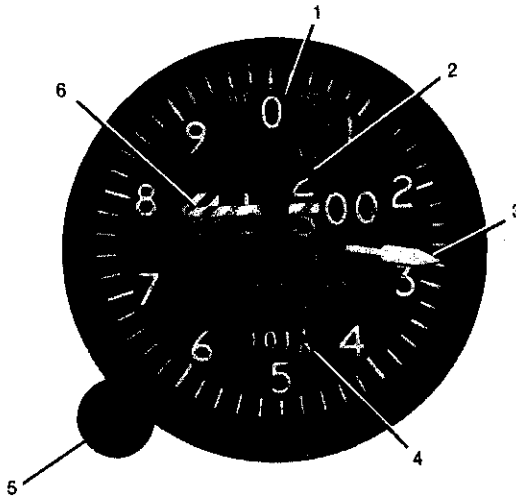
The altitude alerter is a panel-mounted unit which includes all of the operating controls and indicators and the preselector logic circuits. Altitude information for use in the altitude alerter is supplied electronically from the encoding altimeter. Three Minilever switches, mounted on the front panel of the unit, are used to select any altitude between 100 and 35,000 feet in 100-foot increments; the selected altitude is displayed on a digital readout. The preselector control and indicators and an ALERT indicator are also included on the front panel of the unit. All controls and indicators for the altitude alerter are shown in Figure 2.

The altitude capture function is selected by a white pushbutton switch (ARM) which energizes the preselector logic circuits. For altitude capture function operation, the Autopilot System must be turned on but not already engaged in a vertical mode (altitude hold or glideslope coupled). When the Minilever switches are set to the desired altitude and the white ARM pushbutton is pushed in, an amber ARMD panel lamp lights to indicate that the function is "armed". When the airplane reaches the selected altitude, the amber ARMD lamp turns off, and a green CPLD panel lamp on the alerter and the altitude hold (ALT) lamp on the autopilot mode selector lights to indicate that altitude hold mode is operational. If the Minilever switches are repositioned after the preselector has been armed but before altitude hold is engaged, the logic circuits are reset and must be rearmed by again pushing in the ARM switch.

The alert indicator consists of a three-lamp display and a one-second aural tone. The alerting range levels are variable within limits for individual airplane requirements and may be preset for each airplane. As factory installed, a green indicator lamp lights when the airplane altitude is within 300 feet of the selected altitude. When the airplane enters an altitude band from 300 feet to 1000 feet above or below the selected altitude, an amber HI ALERT or LO ALERT lamp lights and simultaneously, the one-second tone is heard. A remotely mounted amber ALT ALERT lamp illuminates when either the HI ALERT or LO ALERT lamps light. At altitudes above or below the 1000-foot alerting range, the alert function does not operate.

SECTION 2 - LIMITATIONS

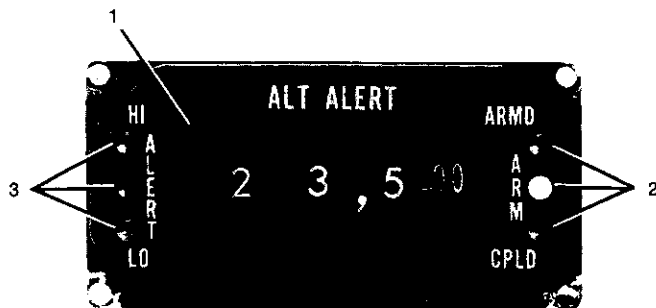
1. A standby barometric altimeter is required when the encoding altimeter is installed.



1014P6042

1. **ZERO-TO-THOUSAND FOOT ALTITUDE DISPLAY DIAL** - Calibrated in 10 numerical graduations which represent increments of 100 feet; the subdivisions of each graduation represent increments of 20 feet.
2. **ALTITUDE READOUT** - Displays altitude above 100 feet on three-section counter in increments of 10,000, 1000, and 100 feet. When altitude is below 10,000 feet, a diagonally striped flag appears in 10,000-foot window.
3. **ZERO-TO-THOUSAND FOOT ALTITUDE DISPLAY POINTER** - Directly indicates airplane altitude between 0 and 1000 feet; for altitudes above 1000 feet, indicates last three digits of altitude (hundreds, tens and ones).
4. **ALTIMETER SETTING READOUT** - Displays altimeter setting set into altimeter with baroset knob on a four-digital counter.
5. **BAROSET KNOB** - Used to set in local altimeter setting; clockwise rotation increases setting, counterclockwise rotation decreases setting.
6. **POWER-OFF WARNING FLAG** - Appears across altitude readout when power is removed from altimeter to indicate that readout is not reliable.

**Figure 1 (Sheet 1 of 1)
ENCODING ALTIMETER INDICATOR**



1014P6072

1. **ALTITUDE SELECTOR AND DISPLAY** - Minilever switches (3) select desired altitude between 100 and 35,000 feet in 100-foot increments. Digital readout displays selected altitude.
2. **ALTITUDE CAPTURE CONTROL AND INDICATORS** - Selector switch and two-lamp indicator which operate as follows:
 - a. **ARM Pushbutton Switch** - Arms altitude capture function of Alerter, provided Autopilot System is turned on and not already engaged in a vertical mode (Altitude hold or glideslope coupled).
 - b. **ARM Amber Lamp** - Lights when ARM pushbutton switch is pushed in and altitude capture function is enabled.
 - c. **CPLD Green Lamp** - Lights when airplane reaches selected altitude and Autopilot System altitude hold mode is automatically engaged.
3. **ALTITUDE ALERT INDICATOR** - Three-lamp indicator which operates within a preestablished range on either side of the selected altitude, as follows:
 - a. **ALERT Green Lamp** - Lights when airplane altitude is within 300 feet of the selected altitude.
 - b. **HI ALERT Amber Lamp** - Lights when airplane altitude is between 300 and 1000 feet above the selected altitude.
 - c. **LO ALERT Amber Lamp** - Lights when airplane altitude is between 300 and 1000 feet below the selected altitude.
 - d. **ALT ALERT Amber Lamp** - This remotely located lamp illuminates when either the HI ALERT or LO ALERT lamps illuminate.

Figure 2 (Sheet 1 of 1)
ALTITUDE ALERTER INDICATOR

SECTION 3 - EMERGENCY PROCEDURES

1. Encoding Altimeter Failure (Warning Flag Showing)
 - a. ENC ALT Circuit Breaker - CHECK IN.
 - b. If warning flag is still showing, use the standby barometric altimeter.

SECTION 4 - NORMAL PROCEDURES

1. Altimeter Operation
 - a. Baro Set Knob - TURN as necessary to set readout to local altimeter setting.
 - b. Power-off Warning Flag - VERIFY that flag is not in view.

WARNING

DO NOT ATTEMPT TO USE ALTIMETER INDICATION FOR FLIGHT INFORMATION IF WARNING FLAG IS IN VIEW. FLAG INDICATES THAT POWER HAS BEEN REMOVED FROM ALTIMETER.

- c. Altitude Display - Below 1000 feet, read altitude on display pointer and dial. Above 1000 feet, read altitude on altitude readout plus pointer and dial indication for last two digits (for example, for an altitude of 12,630 feet, read 12,600 feet on readout; read 30 feet on pointer and dial).
2. Altitude Encoding and Accessory Operation

Operation of the altitude encoding and accessory information functions of the altimeter is completely automatic as soon as power is applied to the altimeter and the warning flag is out of view. However, for transmission of the altitude information to the ground controller, the Mode C (ALT) function must be selected on the transponder.

3. Altitude Alert

NOTE

The altitude alerter must be used with a properly functioning 800 encoding altimeter for all operation.

During flight, altitude alert operation of the altitude alerter is automatic within the preestablished alert range. Operation may be verified on the ground as follows:

- a. Apply power to the equipment. Altimeter power-off warning flag should disappear.
 - b. Set altitude selector switches to slightly more than 1000 feet above the altitude indicated on the encoding altimeter. Altitude is displayed on readout.
 - c. Begin to turn altimeter baroset knob to set altimeter reading to agree with selected altitude. When altitude reading reaches lower limit of alert range, one-second tone is heard and amber LO ALERT lamp lights.
 - d. Continue to turn baroset knob for selected altitude. When altitude reading is within altitude tolerance of alerter, the LO ALERT lamp goes out and the green ALERT lamp lights.
 - e. Turn baroset knob for altitude above altitude tolerance of alerter. Green lamp goes out, one-second tone is heard, and amber HI ALERT lamp lights.
 - f. Continue to turn baroset knob until altitude reading is above alert range. Just as altitude leaves alert range, the HI ALERT lamp goes out.
 - g. Turn off power; power-off warning flag appears.
 - h. Turn baroset knob to reset altimeter as required.
4. Altitude Capture
Altitude capture operation may be verified on the ground as follows:
- a. Turn on airplane power. Power-off warning flag on altimeter should disappear.
 - b. Turn on Autopilot System and verify that a vertical mode is not selected.
 - c. Set altitude selector switches to desired altitude; altitude is displayed on readout.
 - d. Push in ARM pushbutton switch. Amber ARMD lamp lights.
 - e. Turn altimeter baroset knob to set altimeter reading to displayed alerter altitude. When altimeter is set, ARMD lamp goes out and green CPLD lamp lights. The altitude hold indicator lamp on the autopilot mode selector will also light.
 - f. Turn off power. Power-off warning flag appears and all indicator lamps go out.
 - g. Turn baroset knob to reset altimeter as required.
5. Altitude Capture Operating Notes
- a. If the altitude selector switches are moved to a new position after the ARM pushbutton has been pushed in but before the altitude is captured, the alerter logic is reset and the ARM pushbutton must be pushed again to enable the new altitude.

- b. After altitude capture, and altitude hold mode is established; if the airplane leaves the selected altitude, the green CPLD lamp will remain lit. The altitude deviation will be indicated by the altitude ALERT lamps and the discrepancy between the selected altitude displayed on the alerter and the airplane altitude displayed by the altimeter.
- c. If the altitude selector switches are set to a different altitude after altitude capture, the Autopilot System will remain in the altitude hold mode but the green CPLD lamp will go out to indicate that the altitude displayed is not the altitude at which the airplane is being held.
- d. If altitude hold is manually selected on the autopilot mode selector prior to automatic altitude capture, the ARMD lamp will go out, the CPLD lamp will not light, and the capture logic circuits will have to be reset for the next use. The function may be reset after altitude hold is disengaged.

SECTION 5 - PERFORMANCE

Not Applicable.

1

2

400 ENCODING ALTIMETER (EA-401A)

SECTION 1 - GENERAL

This supplement provides information which must be observed when operating the 400 encoding altimeter.

Description

The 400 encoding altimeter (Type EA-401A) is an electrically driven instrument that provides the pilot with a visual display of the airplane's altitude. The altimeter also includes an optical encoder which automatically produces a logic code that corresponds to the sensed altitude. This code is supplied to the Air Traffic Control Radar Beacon System transponder in the airplane to generate replies to Mode C (altitude reporting) interrogations from the ground controller.

The 400 encoding altimeter, refer to Figure 1, is a panel-mounted barometric altimeter with an altitude range of -1000 to +35,000 feet. Altitude is displayed by a dial and a digital readout. The dial is graduated in numerical divisions which represent increments of 100 feet, with subdivision markings for every 20 feet. The dial pointer completes one revolution for every 1000 feet of altitude change. The digital readout displays airplane altitude in increments of hundreds and thousands of feet only. When power is removed from the altimeter, a striped warning flag appears across the digital altitude display to indicate a "power-off" condition.

NOTE

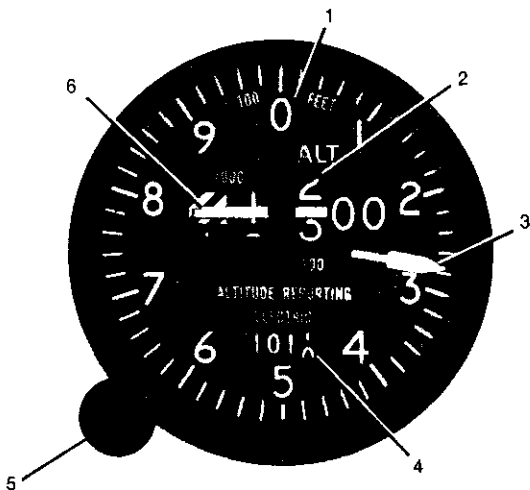
The power-off warning flag is a power warning only.

Local atmospheric pressure corrected to sea level is set into the altimeter with a manually operated baroset knob, and is displayed on a four-digit readout, either in inches of mercury or in millibars (as ordered). This altimeter setting does not effect the output of the optical encoder, since the encoder is always referenced to standard pressure (sea level; 29.92 inches of mercury or 1013.2 millibars).

Except for introducing the altimeter setting with the baroset knob, operation of the altimeter is completely automatic. The baroset knob and the display indicators are shown in Figure 1.

SECTION 2 - LIMITATIONS

1. A standby barometric altimeter is required when the encoding altimeter is installed.



1014P6042

1. **ZERO-TO-THOUSAND FOOT ALTITUDE DISPLAY DIAL** - Calibrated in 10 numerical graduations which represent increments of 100 feet; the subdivisions of each graduation represents increments of 20 feet.
2. **ALTITUDE READOUT** - Displays altitude above 100 feet on three-section counter in increments of 10,000, 1000 and 100 feet. When altitude is below 10,000 feet, a diagonally striped flag appears in the 10,000-foot window.
3. **ZERO-TO-THOUSAND FOOT ALTITUDE DISPLAY POINTER** - Directly indicates airplane altitude between 0 and 1000 feet; for altitudes above 1000 feet, indicates last three digits of altitude (hundreds, tens and ones).
4. **ALTIMETER SETTING READOUT** - Displays the local atmospheric pressure corrected to sea level set into altimeter with baro set knob.
5. **BAROSET KNOB** - Used to set in local altimeter setting; clockwise rotation increases setting, counterclockwise rotation decreases setting.
6. **POWER-OFF WARNING FLAG** - Appears across altitude readout when power is removed from altimeter to indicate that readout is not reliable.

NOTE

The power-off warning flag is power warning only.

Figure 1
400 ENCODING ALTIMETER INDICATOR

SECTION 3 - EMERGENCY PROCEDURES

1. Encoding Altimeter Failure (Warning Flag Showing)
 - a. ALT Circuit Breaker - CHECK IN.
 - b. If warning flag is still showing, use the standby barometric altimeter.

SECTION 4 - NORMAL PROCEDURES

1. Altimeter Operation
 - a. Baroset Knot - TURN as necessary to set readout to desired pressure.
 - b. Power OFF Warning Flag - VERIFY that flag is not in view.

WARNING

DO NOT ATTEMPT TO USE ALTIMETER INDICATION FOR FLIGHT INFORMATION IF WARNING FLAG IS IN VIEW. FLAG INDICATES THAT POWER HAS BEEN REMOVED FROM THE ALTIMETER.

- c. Altitude Display - Below 1000 feet, read altitude on display pointer and dial. Above 1000 feet, read altitude on altitude readout plus pointer and dial indication for last two digits (for example, for an altitude of 12,630 feet, read 12,600 feet on readout and read 30 feet on pointer and dial).
2. Altitude Encoding Operation

Operation of the altitude encoding function of the altimeter is completely automatic as soon as power is applied to the altimeter and the warning flag is out of view. However, for transmission of the altitude information to the ground controller, the Mode C (ALT) function must be selected on the transponder.

SECTION 5 - PERFORMANCE

Not Applicable.

(

(

400 AREA NAVIGATION SYSTEM (RN-479A)**SECTION 1 - GENERAL**

This supplement provides information which must be observed when operating the 400 Area Navigation System (RNAV).

Description

The 400 Area Navigation System referred to as Remote Navigation (RNAV) consists of an RNAV Computer, NAV Receiver, Distance Measuring Equipment (DME) Receiver/Transmitter, DME Control Unit, and Course Indicator.

The 400 RNAV System features ten programmable waypoints, easily selected via keyboard entry. The active, or any memory-stored waypoint, can be selected for display, showing frequency, bearing and distance information in Light Emitting Diode (LED) readouts. Waypoint bearing and distance information is programmed from the VORTAC (VOR/DME) station to the waypoint (WPT).

Frequency, (FREQ) Bearing (BRG) and Distance (DIST) are retained in memory by voltage provided directly from the hot battery bus. This memory voltage is kept alive even after the battery switch as been turned off. To prevent battery discharge during periods of long term storage, it is recommended the FREQ MEM circuit breaker on the right side console be pulled.

NOTE

If the "Memory" voltage is interrupted, all stored information for the RNAV display will be lost. Subsequent operation of the system, with the "Memory" voltage restored, will require re-programming of waypoints.

The RNAV system has three modes of operation:

1. VOR/DME - Regular VOR/DME operation. Distance, ground speed and time-to-station information on the DME display and course information on the course indicator are relative to the VORTAC (VOR/DME) station selected on the associated NAV receiver.
2. RNAV ENROUTE - Distance, ground speed and time-to-station information on the DME display and course information on the course indicator are relative to the active FLY waypoint.

- RNAV APPROACH - Distance, ground speed and time-to-station information on the DME display and course information on the course indicator are relative to the active FLY waypoint. Course width is narrowed for more accurate navigation.

During RNAV operation, a course scalloping suppressor circuit suppresses spurious navigation signal phases to provide stable waypoint information which enhances autopilot operation. This feature may be used to advantage during VOR tracking by programming a waypoint directly over the associated VORTAC (VOR/DME) at (000.0 degree/000.0 Nautical Mile) and using RNAV for course smoothing enroute.

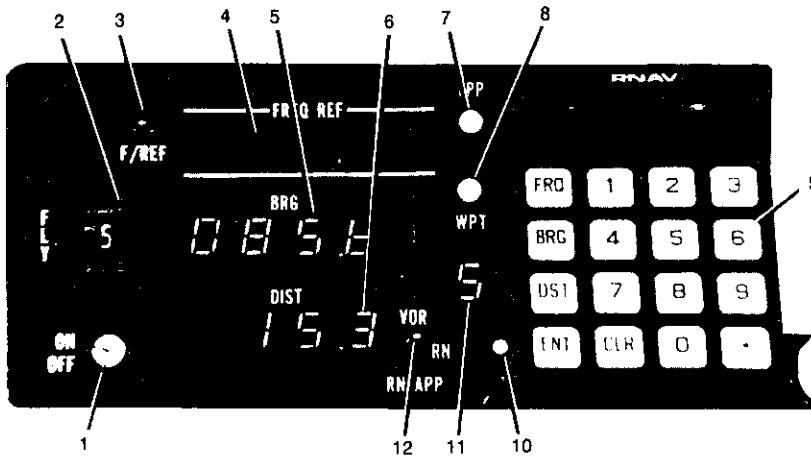
The Load Present Position (LPP) feature allows storage of the airplane position as a waypoint (WPT).

SECTION 2 - LIMITATIONS

Not Applicable.

SECTION 3 - EMERGENCY PROCEDURES

Not Applicable.



- ON/OFF SWITCH - Applies power to the RNAV RN-479A.

5484P6007

Figure 1 (Sheet 1 of 5)
400 AREA NAVIGATION CONTROLS

2. FLY WAYPOINT

SWITCH - Selects active waypoint, displays assigned waypoint number (0-9) in waypoint digit display, and displays programmed bearing (BRG) and distance (DIST).

NOTE

The waypoint will be computed for whichever frequency is selected on the associated NAV receiver. The airplane DOES NOT fly to the frequency displayed in the FREQ REF DATA DISPLAY (4).

3. F/REF (FREQUENCY REFERENCE

SWITCH) - When depressed, recalls stored frequency (if any) corresponding to WPT displayed, for a period of 8 seconds.

4. FREQ REF (Frequency Reference)

DATA DISPLAY - 5 digit LED display indicating the frequency which must be set in the associated NAV receiver. The frequency must be entered from keyboard or recalled from memory using the F/REF SWITCH (3). Any attempt to program frequency data into the waypoint number currently set at the FLY WAYPOINT SWITCH will cause the display to flash "in USE" but new frequency data will not be inhibited from entry.

5. BRG (Bearing)

DATA DISPLAY - 4-digit LED display indicating the waypoint bearing (from the VOR station) in memory or to be put in memory. The origin of this data is the same as described in FREQ REF (4) above. In the event that a localizer frequency has been selected and the system is in the RNAV-ENROUTE (RN) or RNAV-APPROACH (RN APP) mode, "Loc" will flash in the display.

6. DIST (Distance)

DATA DISPLAY - 4-digit LED display indicating the waypoint distance in memory or to be put in memory. The origin of this data is the same as in FREQ REF (4) above. In the event that a localizer frequency has been selected and the system is in the RNAV-ENROUTE or RNAV-APPROACH mode, "FrE" will flash in the display.

**Figure 1 (Sheet 2 of 5)
400 AREA NAVIGATION CONTROLS**

7. LPP (Load Present Position)

PUSH BUTTON

SWITCH - Displays BRG and DIST information of airplane relative to the VOR station selected on the associated NAV receiver. **FREQ REF** display will be blank. Depressing **F/REF** switch will cause "NONE" to be displayed. Flashing cursor in **Waypoint (WPT)** display digit indicates present position may be assigned a waypoint number by depression of a numeric key followed by depression of **ENT** key. If it is desired that present position not be entered as a waypoint, it may be cleared by depressing the **CLR KEY**. If VOR and/or DME data are flagged (invalid), "----" will appear in appropriate display.

8. WPT (Waypoint)

PUSH-BUTTON

SWITCH - Enables preprogrammed waypoint to be called up for display or a new waypoint to be programmed, if desired. Switch depression causes display to blank and waypoint digit display cursor to flash, requesting numeric entry (0-9) from the keyboard. Numeric entry causes waypoint information (BRG and DIST) to be displayed. Flashing cursor in **WPT** digit display now indicates that waypoint displayed its different from waypoint selected by **FLY WAYPOINT SWITCH** and presently being used for navigation. A new waypoint may be entered using keyboard entry. With an active waypoint cursor, depressing the decimal button will start a scan of the waypoint data in memory. At this point, depressing a numeric button will halt the waypoint scanning and the waypoint data for that numbered waypoint will be displayed. If instead of a numeric entry, the decimal is depressed again the scan will stop at the currently displayed waypoint.

Figure 1 (Sheet 3 of 5)
400 AREA NAVIGATION CONTROLS

9. KEYBOARD ENTRY NUMERIC

KEYS - Enter digits 0-9 only when numeric input is requested. **FREQ**, **BRG** and **DIST** information are entered from left to right. Appropriate numeric entry occurs upon each function key switch depression; such as, **FREQ**, 1, 1, 7, 9, 5, **ENT** will enter a frequency of 117.95 MHz to display and waypoint memory.

DECIMAL POINT

KEY - Justifies entered data around decimal point. The unit automatically supplies leading and trailing zeros for **BRG** and **DIST**.

FRQ (Frequency)

KEY - Enters frequency from 108.0-117.95 MHz. Causes **FREQ** display to blank, the prompting cursor to flash in most significant digit position, indicating that numeric entry is requested. A shorthand frequency entry is available. Entry of the unit MHz digit followed by the decimal point key automatically enters the entire correct frequency up to the decimal point, e.g., **FRQ**, 1, decimal point, 6, **ENT** will enter a frequency of 111.6 MHz. The one tenth MHz digit must be entered. The unit will automatically assume "0" for the one hundredth MHz digit unless the "5" digit key is depressed.

BRG (Bearing) KEY - Enters bearing information from 0.0 - 359.9 degrees in same manner as **FRQ** key.

DST (Distance) KEY - Enters distance information from 0.0 - 199.9 nautical miles in same manner as **FRQ** key.

ENT (Enter) KEY - Enters displayed data into waypoint memory at the position indicated by the **WPT** digit display. This key is available only when the **ENTER ANNUNCIATOR (10)** is flashing

CLR (Clear) KEY - Available during waypoint data entry only. Deletes last keyboard entry causing the flashing prompt cursor to back up one position. Repetitive depressions of key can be used to get out of entry mode and return to original display. Can also be used to clear **LPP** information from display and memory. The **CLR** key is disabled when the cursor has disappeared and the enter annunciator is flashing. In this case, if the entered data is not as desired, it may be reentered by depressing the appropriate **FRQ**, **BRG**, or **DST** key.

**Figure 1 (Sheet 4 of 5)
400 AREA NAVIGATION CONTROLS**

10. ENTER ANNUNCIATOR - Flashing annunciator indicates that valid waypoint data has been entered into the display and may be entered into the waypoint memory by depressing ENT key.
11. WPT (Waypoint) Digit
Display - 1-digit LED display indicating the waypoint number assigned to the information in the FREQ, BRG, and DIST data displays. A flashing digit indicates that the digit displayed is not identical to the digit selected by the FLY WAYPOINT SWITCH. A flashing cursor indicates that a numeric entry is requested during waypoint programming.
12. VOR/RN/RN APP MODE Switch
VOR Position - Regular VOR/DME operation; localizer operation if localizer frequency is selected on the associated NAV receiver.
RN Position - Selects RNAV ENROUTE mode. Each dot on the course indicator represents 1 NM in RNAV ENROUTE mode.
RN APP Position - Selects RNAV APPROACH mode. Each dot on the course indicator represent 0.25 NM in RNAV approach mode.

Figure 1 (Sheet 5 of 5)
400 AREA NAVIGATION CONTROLS

SECTION 4 - NORMAL PROCEDURES

1. RNAV Operation

NOTE

Proper RNAV operation requires valid VOR and DME inputs to the RNAV system. In certain areas, the ground station antenna patterns and transmitter power may be inadequate to provide valid signals to the RNAV. For this reason, intermittent RNAV signal loss may be experienced enroute. Prolonged loss of RNAV signal shall require the pilot to select alternate waypoints or revert to other navigational procedures.

- a. RNAV ON/OFF SWITCH - ON.
- b. DME TEST/ON OFF SWITCH - ON.
- c. RNAV MODE SWITCH - RN.

2. Programming Waypoints

NOTE

Using a VFR Sectional, enroute instrument chart, instrument approach plate, or enroute RNAV chart - DETERMINE distance and bearing for desired waypoint(s) from appropriate VOR/DME stations.

- a. WPT - PRESS.
- b. Enter numeric designation (0-9) of waypoint to be programmed.
- c. FRQ - PRESS.
- d. Enter numeric data for frequency to be programmed.
- e. BRG - PRESS (ENTER ANNUNCIATOR extinguishes).
- f. Enter numeric data for bearing to be programmed.
- g. DST - PRESS (ENTER ANNUNCIATOR extinguishes).
- h. Enter numeric data for distance to be programmed.
- i. ENT - PRESS (Data entered, ENTER ANNUNCIATOR extinguishes).
- j. Repeat entire programming procedure for all waypoints to be programmed.
- k. Select desired NAV frequency on navigation receiver.
- l. Select desired active waypoint on FLY WAYPOINT SWITCH for flight.

NOTE

| | |
|-------------------------------|---|
| <i>Ground speed accuracy:</i> | <i>60-800 knots ±12 knots within 2.5 minutes. 60-800 knots ±5 knots within 5 minutes.</i> |
|-------------------------------|---|

| | |
|----------------------------------|----------------------------------|
| <i>Time to station accuracy:</i> | <i>0-500 minutes ±2 minutes.</i> |
|----------------------------------|----------------------------------|

| | |
|----------------------|--|
| <i>Course width:</i> | <i>RNAV-ENROUTE: ±5 NM nominal. RNAV-APPROACH, ±1.25 NM nominal, VOR/DME, ±10 degrees.</i> |
|----------------------|--|

| | |
|---|---|
| <i>Computed waypoint distance accuracy:</i> | <i>RNAV-ENROUTE - Meets AC-90-45A Specifications. RNAV-APPROACH - Meets AC-90-45A Specifications.</i> |
|---|---|

3. RNAV System Self-Test and VOR/DME Cross-Check.

NOTE

Proper RNAV test requires valid VOR and DME signals to the RNAV.

- a. RNAV ON/OFF SWITCH - ON.
- b. DME TEST/ON OFF SWITCH - ON.
- c. RNAV MODE SWITCH - RN.
- d. FLY waypoint as desired.
- e. RNAV programmed to the following waypoint:
 - (1) **FREQ** - not required.
 - (2) **BRG** - any.
 - (3) **DIST** - any.
 - (4) **NAV** frequency as required to produce valid VOR and DME signals.
- f. Course Indicator OBS - Set to 0 degrees.
- g. NAV (RT-485B) ID/VOX/TEST SWITCH - HOLD in TEST position.
 - (1) Course Deviation Indicator - Center ± 2 NM.
 - (2) TO - FROM Course Indicator - Indicates FROM.
 - (3) DME Distance-to-Station Display - Readout is 88.8
 - (4) RNAV VOR/RN/RN APP MODE SWITCH - SET TO VOR. Verify that the DME distance remains 88.8 and that the Course Deviation Indicator remains centered.

NOTE

● *After releasing the area navigation test switch, a return to accurately computed bearing and distance data may take up to one minute, depending upon the airplane position and waypoint.*

● *This test does not fulfill the requirement of FAR 91.25.*

- h. Additionally, crosscheck the RNAV as follows:
 - (1) RNAV - PROGRAM waypoint at 000.0 degree/000.0 nautical miles.
 - (2) Course Indicator - Turn course selector to center the course deviation indicator. Note the RNAV distance to waypoint on the DME control unit.

- (3) RNAV MODE SWITCH - Set to VOR. Verify that the DME distance is the same as in preceding step h.(2), and that the course deviation indicator remains centered.
4. Keyboard/Display Reliability Tests.
- a. RNAV ON/OFF - ON.
 - b. DME TEST/ON/OFF TEST - ON.
 - (1) RNAV Display - Illuminated.
 - (2) WPT Digit Display - Same digit as FLY WAYPOINT selection.
 - (3) DME Display - NM Illuminated.
 - c. RNAV Mode Switch - RN.
 - (1) Course Deviation Indicator RN light - Illuminated.
 - (2) DME display - RN illuminated.
 - d. FLY WAYPOINT SWITCH - TURN to "0".
 - e. WPT - PRESS.
 - (1) Display blanks.
 - (2) WPT Digit Display cursor flashing.
 - f. Enter "0" from keyboard.
 - g. FRQ - PRESS.
 - (1) FREQ Display alternately indicates "in USE".
 - h. Enter 110.10 from keyboard.
 - (1) ENTER ANNUNCIATOR flashing.
 - i. ENT - PRESS.
 - (1) ENTER ANNUNCIATOR extinguishes.
 - j. On 400 (RT-485B) NAV Receiver Enter -110.10.
 - (1) BRG, DIST Displays on RN-479A alternately flashes - "Loc, FrE" and Annunciator on DME flashes.
 - k. RNAV Mode Switch - VOR.
 - (1) "Loc, FrE" no longer displayed.
 - l. RNAV Mode Switch - RN.
 - m. FRQ PRESS.
 - n. Enter 110.0 from keyboard.
 - (1) FREQ Display cursor prompts entry and remains in least significant position.
 - o. ENT - PRESS.
 - (1) Frequency enters as 110.00
 - (2) ENT ANNUNCIATOR extinguishes.
 - p. On 400 (RT-485B) NAV Receiver - ENTER 110.10

- q. BRG - PRESS.
- r. Enter 3-digit bearing - (ERROR SIGNAL IF ENTRY IS GREATER THAN 359.9).
 - (1) BRG Display cursor prompts entry and remains in least significant position.
- s. ENT - PRESS.
 - (1) Bearing information enters with "0" as fourth digit.
 - (2) ENTER ANNUNCIATOR extinguishes.
- t. DST - PRESS.
- u. Enter 3-digit distance (ERROR SIGNAL IF ENTRY IS GREATER THAN 199.9).
 - (1) DIST Display cursor prompts entry and remains in least significant position.
- v. ENT - PRESS.
 - (1) Bearing information entered with "0" as fourth digit.
 - (2) ENTER ANNUNCIATOR extinguishes.

SECTION 5 - PERFORMANCE

Not Applicable.

400 DME (R-477A)**SECTION 1 - GENERAL**

This supplement provides information which must be observed when operating the 400 Distance Measuring Equipment (DME).

Description

The 400 DME comprises the Receiver-Transmitter, (RTA-477A), Control Unit (C-477A) and Antenna (C-105-3). This equipment is used with the 400 NAV and/or 400 RNAV system. The DME is dependent on the NAV system for frequency channel selection. The DME provides continuous and accurate slant range, ground speed and time to station information to the selected VORTAC (VOR/DME) ground station. In the NAV mode, this information is computed to the FLY waypoint (WPT).

The receiver-transmitter transmits interrogation pulses on any of the 100 channels between 1041 MHz and 1150 MHz; it receives return ground-to-air pulses between 978-1087 MHz and 1104-1213 MHz. Equipment cooling is provided by a fan which circulates air from the nosewheel well into the avionics bay. The fan is controlled by the EQUIP FAN circuit breaker.

SECTION 2 - LIMITATIONS

Not Applicable.

SECTION 3 - EMERGENCY PROCEDURES

Not Applicable.

SECTION 4 - NORMAL PROCEDURES**1. DME Operation**

- a. TST/ON/OFF Switch - ON.
- b. DME channel selection. Channel selection from the NAV 1 and/or NAV 2 systems may be accomplished by using a 400 NAV receiver control unit. (Select N1, HLD or N2 as appropriate.)
- c. TST/ON/OFF SWITCH - TEST and Release.
 - (1) Annunciators NM, KTS, MIN, N1, HLD, and N2 will illuminate. Annunciator RN will not illuminate and it will extinguish if previously illuminated. Any digital readout previously illuminated will extinguish.

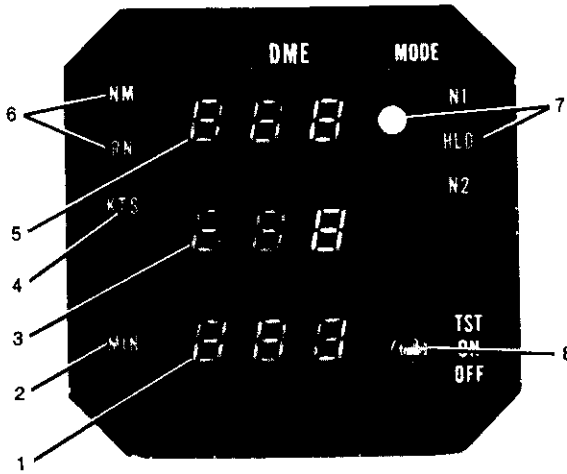
- (2) In approximately one second all annunciators will extinguish except NM, KTS and MIN will also remain on if they were illuminated prior to going to TEST (i.e. if locked on to a valid DME signal).
- (3) Approximately three seconds later 8's will appear in the nine digital readouts.
- (4) Approximately four seconds later the annunciators will return to the appropriate responses for the DME frequency selected. The digit readouts may then require some additional time to adequately lock on to this frequency

NOTE

When the 400 RNAV (RN479) is installed with a single DME, the DME will be slaved to the Nav control unit to which the RNAV is assigned when the RNAV is operated in the RNAV mode (RN or RN APP). The DME N1/HLD/N2 button will be inoperative.

SECTION 5 - PERFORMANCE

Not Applicable.



5484P6004

1. Time-To-Station Display (0.999 minutes)
In VOR mode, readout is relative to VORTAC (VOR/DME) station.
In RNAV (RN-RN APP) mode, readout is relative to FLY waypoint.
2. MIN (minutes) Annunciator - Illuminates with Time-To-Station display.
3. Ground Speed Display.
Displays ground speed in knots.
4. KTS (knots) Annunciator.
KTS - Illuminates to indicate display (3) is ground speed in knots.
5. Distance-To-Station Display - Distance to station in nautical miles (00.0 to 300 NM).
6. NM/RN Annunciator.
NM - Always illuminated - Indicates that Distance-To-Station display (5) is in nautical miles for all modes of operation.
RN- Not illuminated - Distance-To-Station display is to VORTAC (VOR/DME) station.
- Illuminated - Distance-To-Station display is to FLY (RNAV) waypoint.

Figure 1 (Sheet 1 of 2)
400 DME CONTROLS

7. N1/HLD/N2 Mode Switch and Annunciator. This switch inoperative in the RNAV mode.
 - N1 - Selects and Indicates Navigation receiver 1.
 - HLD - Holds the frequency of receiver N1 or N2, whichever was last selected, so that it may be used for DME operation. N1 and N2 become independent of DME operation and may be used for other purposes.
 - N2 - Selects and Indicates Navigation receiver 2.
8. TST/ON/OFF Switch.
 - ON - Controls power to RTA-477A and C-477A. NAV 2 is automatically selected at Power On in most configurations.
 - TST - Self tests for the RTA-477A and C-477A. Momentary depression of the TST Switch causes all annunciation lights to illuminate. Approximately one second after release of the TST switch all 8's will appear in the digital readout windows for a few seconds and then normal DME operation will resume. N1, HLD or N2 selection remains the same.

Figure 1 (Sheet 2 of 2)
400 DME CONTROLS

1000A FLIGHT CONTROL SYSTEM (AF-1050A)**SECTION 1 - GENERAL**

This supplement provides information which must be observed when operating the 1000A Flight Control System.

Description

The 1000A Flight Control System is a two-axis autopilot system that controls the ailerons and elevators to maintain the airplane at a desired attitude. A yaw damper is also included in the system. The status of the system is displayed on the mode selector, the autopilot control panel, the horizontal situation indicator (HSI), the attitude gyro, and the autopilot mode repeater annunciators on the pilot's panel.

A horizontal situation indicator (HSI), or directional gyro, displays a pictorial presentation of the airplane's position relative to VOR radials, localizer courses and glideslope beams. The HSI also gives heading reference with respect to magnetic north and provides for selection of the desired heading, VOR radial and LOC course.

Precision attitude information is provided on the attitude gyro, refer to Figure 3.

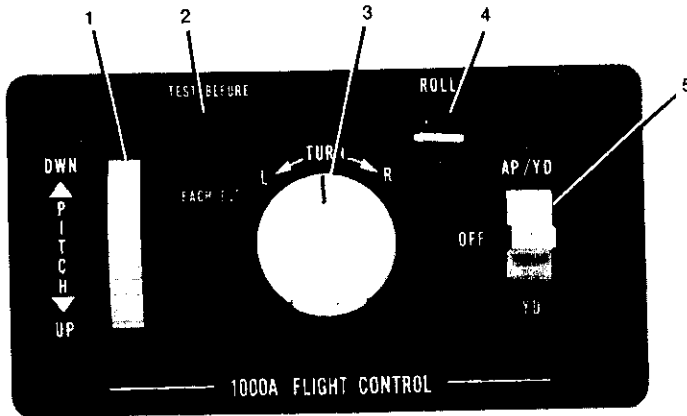
For autopilot engagement, the autopilot/yaw damper switch on the autopilot control panel, refer to Figure 1, is placed in the AP/YD position. Pitch and turn manual command controls are located on this control panel. All other modes of flight are controlled from the mode selector.

The autopilot/yaw damper switch, when in the AP/YD position, also energizes the yaw damper system which functions independently of the autopilot. The yaw damper can be independently engaged by placing the AP/YD switch in the YD position.

A disconnect function is provided to automatically disconnect the autopilot any time the airplane pitch attitude exceeds approximately 20 degrees up or down. The operational capability of the disconnect function should be tested before takeoff by pressing the TEST BEFORE EACH FLT button, located on the autopilot control panel. When the test button is pressed with the autopilot engaged, a test voltage is inserted into the attitude monitor circuitry, causing autopilot disconnect. This button must not be pressed in flight; it is for ground check only. The control wheel must be restrained during the test.

The pilot's control wheel, refer to Figure 4, incorporates switches for autopilot related operations. An electric elevator trim switch and an autopilot/electric elevator trim (AP/TRIM DISC) disconnect switch are provided on the pilot's left control horn. The pilot's right control horn incorporates a pitch synchronization button.

The autopilot off (AP OFF) light, located adjacent to the attitude gyro, will illuminate when the autopilot is disconnected by any means other than the control wheel AP/TRIM DISC switch. The AP OFF light will remain on until it is cancelled by pressing the control wheel AP/TRIM DISC switch. Any time the autopilot disconnects, the disconnect horn will produce a short tone lasting 1 to 2 seconds with decreasing amplitude.



5914P6013

1. PITCH COMMAND

WHEEL - Controls pitch attitude of the airplane. When rotated, commands pitch up or down. Pitch attitude change is proportional to the amount of rotation of the pitch command wheel. Rotation of the wheel disengages the ALT ENG or GS ENG modes. Rotation of the wheel does not affect GS ARM mode.

2. TEST BEFORE EACH FLT

BUTTON - Pressing this switch with the autopilot engaged, tests the pitch attitude monitor circuitry, causing autopilot disconnect.

3. TURN COMMAND

KNOB - Must be centered for AP engagement. Commands roll attitude proportional to control rotation. Maximum command is nominally 25 degrees roll attitude. Rotation out of detent disengages HDG or NAV modes.

4. ROLL TRIM

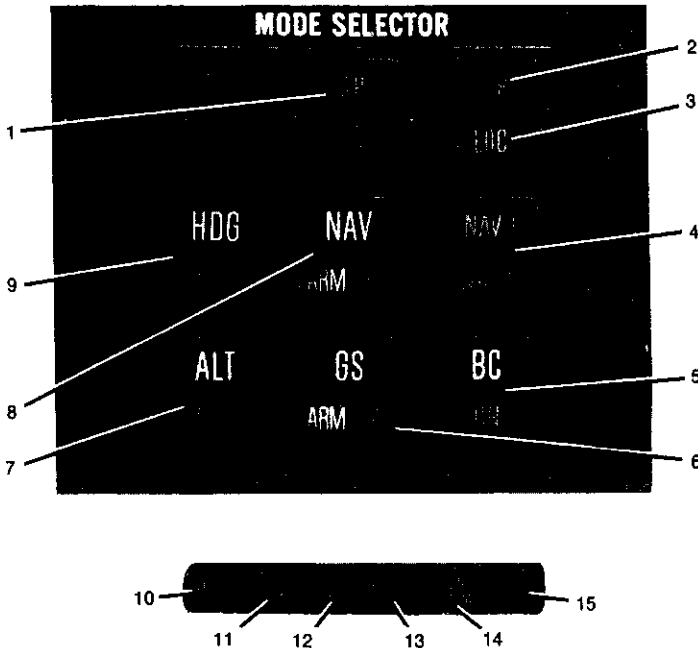
INDICATOR - Indicates direction of autopilot roll effort. Continuous deflection in either direction during steady flight indicates that manual adjustment of the airplane aileron trim is required in the same direction. Indicator is active with autopilot engaged or disconnected.

**Figure 1 (Sheet 1 of 2)
AUTOPILOT CONTROL PANEL**

5. AUTOPILOT/YAW DAMPER

SWITCH - Magnetically held three-position switch. In the center position, the system is off. Placing the switch in the AP/YD position engages the autopilot and yaw damper. The AP annunciator on the mode selector will light, and the yaw damper flag on the turn and bank indicator will be pulled out of view. In the YD position, only the yaw damper system is engaged.

Figure 1 (Sheet 2 of 2)
AUTOPILOT CONTROL PANEL



5984P6005
5714P6016

1. AUTOPILOT (AP) ANNUNCIATOR LIGHT - AP annunciates green when autopilot is engaged.

Figure 2 (Sheet 1 of 4)
MODE SELECTOR AND MODE REPEATER ANNUNCIATORS

2. VOR ANNUNCIATOR LIGHT - VOR annunciates green when selected NAV receiver is tuned to VOR frequency.
3. LOC ANNUNCIATOR LIGHT - LOC annunciates green when selected NAV receiver is tuned to localizer frequency.
4. NAV 1/NAV 2 SWITCH/
ANNUNCIATOR - Alternate action manual switch that selects NAV 1 or NAV 2 navigation system for coupling to autopilot. Appropriate segment annunciates green when selected.
5. BACK COURSE (BC/ON) SWITCH/
ANNUNCIATOR - Momentary switch selects back course mode independent of autopilot engagement, if selected NAV is tuned to a localizer frequency. If NAV 1 is selected, and both NAV's are tuned to localizer frequencies, the CDI display reverses on NAV 2 non-HSI type indicators. BC annunciates green when mode is selected.
6. GLIDESLOPE (GS) SWITCH/
ANNUNCIATOR - Momentary alternate action switch arms glideslope mode if selected navigation receiver is tuned to a localizer frequency and NAV mode is armed or engaged. ARM will announce amber when glideslope is armed. Depressing the switch again will disengage ARM mode. The ENG annunciator will illuminate green when the glideslope is captured. Depressing the switch again will disengage ENG mode. ENG blinks when the selected glideslope receiver is in an alarm condition; glideslope remains coupled to the autopilot. Glideslope will arm and engage with front or back course selected.
7. ALTITUDE (ALT) MODE SWITCH/
ANNUNCIATOR - Momentary switch engages or disengages altitude hold mode. ENG annunciates green when mode is engaged.

Figure 2 (Sheet 2 of 4)
MODE SELECTOR AND MODE REPEATER ANNUNCIATORS

8. NAV MODE SWITCH/
ANNUNCIATOR - Momentary activation engages or disengages NAV ARM or the NAV ENG mode, dependent on HDG mode status and position of the airplane relative to the beam center. If HDG mode is not engaged, NAV mode will engage immediately and be annunciated by ENG lighting green. The airplane will turn to intercept the beam at a fixed intercept angle. If HDG mode is engaged, and beam displacement is greater than a preset amount on the course deviation indicator, (one half scale for VOR enroute, full scale for VOR with wing flaps at T.O. or more selected, and full scale for localizer operation), the HDG mode will remain engaged and the NAV mode will arm. An amber ARM annunciation will appear below the white NAV. The airplane will continue on the selected heading until the beam displacement decreases to less than the preset amount, at which time NAV mode will automatically engage and HDG mode will disengage. The ARM annunciation will also extinguish and the ENG annunciation will light green. The airplane will then turn to capture the beam. ENG blinks when the selected NAV receiver is in a flag alarm condition. However, NAV remains coupled to the autopilot.
9. HEADING (HDG) MODE SWITCH/
ANNUNCIATOR - Momentary switch engages or disengages the heading mode. ENG annunciates green when mode is engaged. Heading mode engagement will cancel NAV mode.

NOTE

The HDG, NAV, ALT, GS, and BC push buttons are illuminated white on the mode selector. With the MASTER LIGHTING switch in the NIGHT position, the intensity of the lights on the MODE SELECTOR and MODE REPEATER is controlled by the RADIO PANEL LIGHT INTENSITY CONTROL.

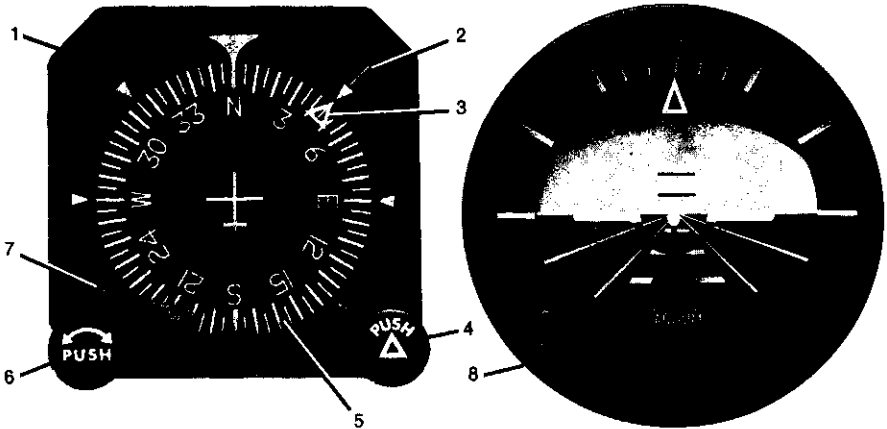
**Figure 2 (Sheet 3 of 4)
MODE SELECTOR AND MODE REPEATER ANNUNCIATORS**

MODE REPEATER ANNUNCIATORS

- 10. HDG ANNUNCIATOR - Indicates autopilot is engaged in heading mode.
- 11. NAV ANNUNCIATOR - Indicates autopilot is engaged in navigation mode. Blinks when selected NAV receiver is flagged.
- 12. BC ANNUNCIATOR - Indicates back course is selected.
- 13. ALT ANNUNCIATOR - Indicates autopilot is engaged in ALT mode.
- 14. GS ARM ANNUNCIATOR - Indicates autopilot is in glideslope ARM mode.
- 15. GS ANNUNCIATOR - Indicates autopilot is engaged in glideslope mode. Blinks when selected glideslope receiver is flagged.

Figure 2 (Sheet 4 of 4)

MODE SELECTOR AND MODE REPEATER ANNUNCIATORS



5984P6026
1014P6055

- 1. DIRECTIONAL GYRO - Displays heading of the airplane when properly set to agree with the magnetic compass.

Figure 3 (Sheet 1 of 2)
DIRECTIONAL AND ATTITUDE GYROS

2. **GYRO SLAVING INDICATOR** - Displays synchronization of compass card with respect to the magnetic flux detector unit. The heading selector knob (PUSH-TURN) may be used at any time to accomplish synchronization of the compass card reading with the magnetic heading as indicated by zeroing the slaving indicator. A slaved condition is present when the slaving indicator oscillates about the null point (45 degrees fixed reference line on the Slaved Gyro).
3. **HEADING BUG** - Displays the selected heading relative to the compass card.
4. **HEADING SELECTOR KNOB** - The heading bug is positioned by rotating the directional gyro HDG selector knob.
5. **COMPASS CARD** - Rotates to display airplane heading.
6. **COMPASS CARD KNOB** - When pushed in, allows manual setting of the compass card to agree with the magnetic compass. The unslaved directional gyro compass card must be reset periodically to compensate for precessional errors in the gyro.
7. **SLAVING OFF FLAG** - Flag showing indicates failure of vacuum and/or DC power to slaved gyro instrument.
8. **ATTITUDE GYRO** - Displays airplane attitude as a conventional attitude gyro. Pitch attitude scale is graduated in 5 degree increments and roll reference scale is graduated in 0, 10, 20, 30, 60, and 90 degrees.

Figure 3 (Sheet 2 of 2)
DIRECTIONAL AND ATTITUDE GYROS



1014P6019

1. **AIRPLANE CONTROL WHEEL ELECTRIC TRIM SWITCH** - When moved forward to the DN position, the elevator trim tab moves in the nose-down direction; conversely, moving the switch aft to the UP position moves the tab in the nose-up direction. The electric trim switch will disconnect autopilot if engaged.
2. **AUTOPILOT/ELECTRIC ELEVATOR TRIM DISCONNECT SWITCH (RED)** - Disconnects the autopilot and a short (1 to 2 seconds) tone with decreasing amplitude is heard in the cockpit. Disables the electric trim while the switch is depressed.
3. **PITCH SYNCHRONIZATION BUTTON** - Upon autopilot engagement, the pitch axis is instantaneously synchronized to existing pitch attitude. When engaged, the airplane can be manually flown to a new pitch attitude by keeping the pitch synchronization button depressed. Depressing the button also disengages the altitude hold mode. Pitch synchronization is inhibited when glideslope is engaged.

Figure 4
CONTROL WHEEL

SECTION 2 - LIMITATIONS

AUTOPILOT:

1. Autopilot and yaw damper must be off for takeoff and landing.
2. Approach VOR radial at an angle of 135 degrees or less prior to engaging the navigation mode.
3. Approach localizer at an angle of 90 degrees or less prior to engaging the navigation mode.
4. Disconnect autopilot if malfunction occurs.
5. Minimum speed for autopilot operation is 120 KIAS.
6. Maximum speed for autopilot operation is 229 KIAS/0.52 Mach, V_{MO}/M_{MO} .
7. Do not use autopilot below 200 feet above ground level in approach.
8. Do not use autopilot below 500 feet above ground level during enroute operations.
9. Do not engage altitude hold mode with vertical speed above 1500 feet per minute.
10. Fuel must remain balanced for all autopilot operations.

SECTION 3 - EMERGENCY PROCEDURES

ELECTRIC ELEVATOR TRIM RUNAWAY

1. **Control Wheel - OVERPOWER as required.**
2. **AP/TRIM DISC Switch - DISCONNECT immediately.**
3. **Manual Elevator Trim - AS REQUIRED.**

NOTE

After the electric trim has been disconnected and the emergency is over, pull the electric trim (ELEV TRIM) circuit breaker. Do not attempt to use the electric elevator trim system until ground maintenance has been completed.

AUTOPILOT EMERGENCIES

AUTOPILOT MALFUNCTION

1. **Elevator or Aileron Control - OVERPOWER as required.**
2. **AP/TRIM DISC Switch - DISCONNECT immediately.**

NOTE

If autopilot malfunctions, the possible altitude loss (includes altitude loss prior to pilot recognition) for cruise, climb, descent configuration and maneuvering flight is 500 feet. For approach configuration the altitude loss is 120 feet.

NOTE

After the autopilot has been disconnected and the emergency is over, pull the roll and pitch actuator (ACT) circuit breaker. Do not attempt to use the autopilot until ground maintenance has been completed.

ENGINE FAILURE

1. Aircraft - CONTROL as required.
2. Inoperative Engine Propeller - FEATHER.
3. AP/TRIM DISC Switch - DISCONNECT.
4. Operative Engine - INCREASE POWER, as required.
5. Landing Gear - UP.
6. Wing Flaps - UP or as required.
7. Trim Tabs - ADJUST.
8. Inoperative Engine - SECURE.

ENGINE INOPERATIVE COUPLED APPROACH

1. Fuel - BALANCED.
2. Trim Tabs - ADJUST.
3. Autopilot - ENGAGE per VOR, ILS/Localizer Coupling Procedure.
4. Engine Inoperative Landing Checklist - COMPLETED.

SECTION 4 - NORMAL PROCEDURES**ELECTRIC ELEVATOR TRIM DISCONNECT CHECK**

1. Operate the electric trim switch in one direction and observe motion of the manual pitch trim wheel in the proper direction. While performing the above test, momentarily depress AP/TRIM DISC switch and release. Observe that manual pitch trim wheel motion is arrested and remains stopped when the disconnect switch is released and electric trim switch is actuated.
2. Repeat Step 1. in the opposite direction.

AUTOPILOT ATTITUDE MONITOR DISENGAGE CHECK (WITH GYRO ERECTED)**BEFORE TAKEOFF**

1. Turn Command Knob - CENTER DETENT.
2. Autopilot/Yaw Damper Switch - AP/YD. Observe annunciation on mode selector for AP engage, and that the turn and bank yaw damper flag is retracted.

3. TEST BEFORE EACH FLT Test Button - PUSH and HOLD.
4. Verify the following:
 - a. Autopilot/Yaw Damper Switch - OBSERVE return to OFF position.
 - b. AP OFF Light - OBSERVE illumination.
 - c. Autopilot Disconnect Horn - OBSERVE 1 to 2 second decreasing aural tone.
5. AP/TRIM DISC Switch - PUSH to turn off the AP OFF light.
6. Autopilot/Yaw Damper Switch - AP/YD - OBSERVE annunciation.

BASIC AUTOPILOT OPERATION

BEFORE ENGAGEMENT

1. Airplane Elevator, Aileron and Rudder Trim - ADJUST.

ENGAGEMENT

1. Turn Command Knob - CENTER DETENT.
2. Autopilot/Yaw Damper Switch - AP/YD. OBSERVE AP annunciation.

NOTE

Airplane rudder trim will have to be adjusted as required for ball centered flight. Airplane aileron trim will have to be readjusted as indicated by the roll trim indicator on the autopilot control panel to compensate for large airspeed or configuration changes. Trim toward the roll trim indicator deflection.

TURN COMMANDS

1. Turn Command Knob - ROTATE as desired.

PITCH COMMANDS

1. Pitch Command Wheel - ROTATE as desired. (Or)
2. Pitch Synchronization Button - PRESS and HOLD. Manually place airplane at desired attitude, then release button.

DISCONNECT

1. AP/TRIM DISC Switch - DISCONNECT. (Or)
2. Autopilot/Yaw Damper Switch - OFF. (Or)
3. Pilot's Electric Elevator Trim Switch - ACTUATE.

NOTE

●Normal autopilot disconnect should be conducted with the pilot's control wheel AP/TRIM DISC switch. The AP OFF light will not illuminate, but the autopilot disconnect horn will produce a short tone lasting 1 to 2 seconds with decreasing amplitude.

●If the autopilot disconnects by any means other than the activation of the pilot's control wheel AP/TRIM DISC switch, the AP OFF light will continuously illuminate and the autopilot disconnect horn will produce a short tone lasting 1 to 2 seconds with decreasing amplitude. The AP OFF light may be extinguished by cycling the pilot's control wheel AP/TRIM DISC switch.

●Autopilot disconnect with the AP/YD switch will illuminate the AP OFF light and the autopilot disconnect horn will produce a short tone lasting 1 to 2 seconds with decreasing amplitude.

ALTITUDE HOLD

ENGAGEMENT

CAUTION

DO NOT OPERATE THE AUTOPILOT IN ALTITUDE HOLD MODE WHEN FLYING IN MODERATE TO SEVERE TURBULENCE, MOUNTAIN LEE WAVE ACTIVITY AND/OR MODERATE TO SEVERE ICING CONDITIONS.

NOTE

To obtain smooth altitude captures, decrease vertical speed to 1500 feet per minute or less and decrease airplane pitch attitude to within 5 degrees of level when approaching desired altitude.

1. With Basic FCS:
 - a. Altitude Hold Mode Selector Button - PRESS at desired altitude. Observe annunciation.
2. With Optional Altitude Alert/Preselect System:
 - a. Desired Altitude - SELECT.
 - b. Altitude Alert/Preselect Arm Button - PUSH. Observe that amber ARMD light illuminates.

NOTE

The altitude alert/preselect ARMD mode is inoperative when the autopilot is in the altitude hold or glideslope mode. Once armed, the altitude alert/preselect mode can be disarmed by reselecting a different altitude on the altitude preselect presentation, by selecting the altitude hold mode on the mode selector or, by glideslope capture.

- c. Pitch Command Wheel - UP or DOWN as required to intercept selected altitude.
- d. When selected altitude is captured, OBSERVE:
 - (1) Altitude alert/preselect amber ARMD light goes OFF.
 - (2) Altitude alert/preselect green CPLD light illuminates.
 - (3) Mode selector ALT ENG annunciator illuminates green.
 - (4) Remote Annunciator ALT illuminates.

NOTE

After engagement, and when the airplane has transitioned to level flight, the altitude hold mode may maintain the airplane at an altitude slightly above or below the selected altitude. If the altitude difference is objectional, disengage the altitude hold mode and acquire the desired altitude, either by using the pitch command wheel, or by holding the pitch synchronization button and manually pitching the airplane until the desired indicated altitude is reached. Then reengage altitude hold mode.

DISENGAGEMENT

1. Altitude Hold Mode Selector Button - ACTUATE. (Or)
2. Pitch Synchronization Button - PRESS. (Or)
3. Pitch Command Wheel - ROTATE.

NOTE

Altitude hold mode will automatically disengage in the coupled ILS mode when the glideslope is engaged.

HEADING SELECT FUNCTION**ENGAGEMENT**

1. Turn Command Knob - CENTER DETENT.
2. HSI Heading Selector Knob - ROTATE bug to desired magnetic heading.
3. Heading Mode Selector Button - ACTUATE. Observe annunciation.
4. Remote Annunciator HDG illuminates.
5. HSI Heading Selector Knob - ADJUST for any subsequent desired heading changes.

NOTE

● *When an optional copilot's horizontal situation indicator is installed and connected to the autopilot, the pilot's heading bug controls the heading when NAV 1 receiver is selected by the mode selector NAV 1/NAV 2 switch, and the copilot's heading bug controls heading when NAV 2 receiver is selected. When a copilot's directional gyro is installed, the pilot's heading bug controls the heading when NAV 1 or NAV 2 receivers are selected.*

● *When an optional copilot's horizontal situation indicator is installed and not connected to the autopilot, the pilot's heading bug controls the heading when NAV 1 receiver or NAV 2 receiver is selected by the mode selector NAV 1/NAV 2 switch.*

DISENGAGEMENT

1. Heading Mode Selector Button - ACTUATE. (Or)
2. Turn Command Knob - ROTATE. (Or)
3. Navigation Mode - AUTO ENGAGE.

VOR COUPLING

ENGAGEMENT (VOR)

1. NAV 1/NAV 2 Mode Selector Button - SELECT NAV 1, NAV 2. Observe proper annunciation (including VOR annunciator on mode selector).
2. Course Selector Knob - ADJUST to desired VOR course.
3. Wing Flaps - T.O. if VOR approach is desired.

NOTE

Wing Flaps must be positioned to T.O. or lower to obtain the VOR approach mode.

4. Airspeed - 120 to 160 KIAS for VOR approach.
5. Turn Command Knob - CENTER DETENT.
6. Navigation Mode Selection.
 - a. Variable Angle Intercept.
 - (1) HSI Heading Selector Knob - ROTATE bug to the desired heading (within 135 degrees of desired VOR course).
 - (2) Heading Mode Selector Button - PRESS. Observe ENG green annunciation on mode selector and HDG on remote annunciator.
 - (3) Navigation Mode Selector Button - PRESS. Observe annunciation of NAV ARM on mode selector. Airplane will continue flying selected heading until the course deviation indicator moves off the peg in the VOR approach mode or half scale in the VOR enroute mode. HDG green ENG and NAV amber ARM annunciators on the mode selector and HDG on remote annunciator will then go out and NAV green ENG annunciator and remote annunciator NAV will light to indicate engagement.

NOTE

With an intercept angle in HDG mode of less than 45 degrees at the time NAV engage occurs, the airplane will initially turn toward the track and establish a 45 degrees intercept angle followed by a turn in the opposite direction to the heading required for a smooth intercept. With the intercept angle in HDG mode greater than 45 degrees, the airplane will initially turn to the heading required for a 45 degrees intercept.

- b. Fixed Angle Intercept.
 - (1) Heading Mode - DISENGAGE (if engaged).
 - (2) Maneuver the airplane to within 135 degrees of the desired VOR course.
 - (3) Navigation Mode Selector Button - ACTUATE. Observe NAV green ENG annunciation on mode selector and NAV on remote annunciator. Airplane will turn to intercept the VOR beam at 45 degrees intercept angle.
- 7. Propeller Control Levers - FORWARD prior to fix inbound.
- 8. Landing Gear - DOWN at final fix if both engines operating.
- 9. Wing Flaps - APPR.
- 10. Airspeed - 120 to 140 KIAS.

NOTE

Verify roll trim indicator is neutral after final configuration is complete. Readjust aileron trim tab as required.

- 11. Landing Gear - DOWN within gliding distance of field if engine inoperative landing.
- 12. AP/TRIM DISC Switch - DISCONNECT at minimum descent altitude.
- 13. Wing Flaps - LAND when landing is assured.

DISENGAGEMENT (VOR)

- 1. Navigation Mode Selector Button - ACTUATE. (Or)
- 2. Turn Command Knob - ROTATE. (Or)
- 3. Heading Mode Selector Button - ACTUATE.

NOTE

Complete autopilot disconnect should normally be conducted on a VOR approach at the appropriate minimums or by 200 feet above ground level with the pilot's control wheel AP/TRIM DISC switch.

ILS/LOCALIZER COUPLING

ENGAGEMENT (ILS)

1. NAV 1/NAV 2 MODE Selector Button - SELECT NAV 1, NAV 2, observe proper annunciation on mode selector. Observe LOC annunciation on mode selector.
2. Course Selector Knob - ADJUST to localizer front course bearing for both front and back course approaches.
3. Back Course Mode Selector Button - ACTUATE as applicable. Observe BC green ON annunciation on mode selector and on the remote annunciator.
4. Wing Flaps - T.O.
5. Airspeed - 120 to 160 KIAS.
6. Turn Command Knob - CENTER DETENT.
7. Altitude Hold Mode Selector Button - ACTUATE as appropriate if desired. Observe annunciation.
8. Navigation Mode Selection
 - a. Variable Angle Intercept.
 - (1) HSI Heading Selector Knob - ROTATE bug for radar vectors and/or 30 degrees to 90 degrees localizer intercept angle. Intercept localizer before the outer marker.
 - (2) Heading Mode Selector Button - ACTUATE. Observe annunciation.
 - (3) Navigation Mode Selector Button - ACTUATE. Observe annunciation of NAV ARM on mode selector. Airplane will continue flying selected heading until the course deviation indicator moves off the peg. HDG green ENG and NAV amber ARM annunciators on mode selector will then go off and NAV green ENG annunciator and NAV on remote annunciator will light, indicating NAV engagement.

NOTE

With an intercept angle in HDG mode of less than 30 degrees at the time NAV engage occurs, the airplane will initially turn toward the track and establish a 30 degrees intercept angle followed by a turn in the opposite direction to the heading required for a smooth intercept. With the intercept angle in HDG mode greater than 30 degrees, the airplane will initially turn to the heading required for a 30 degrees intercept.

- b. Fixed Angle Intercept.
- (1) Heading Mode - DISENGAGE if engaged.
 - (2) Maneuver airplane to within 90 degrees of localizer bearing.
 - (3) Navigation Mode Selector Button - ACTUATE. Observe NAV green ENG annunciation on mode selector and NAV on the remote annunciator. Airplane will turn to intercept the localizer beam at a 30 degrees intercept angle.
9. Glideslope Mode Selector Button - ACTUATE. Observe annunciation of GS ARM on mode selector and on the remote annunciator. Maneuver airplane to intercept the glideslope. GS green ENG annunciation will indicate glideslope engagement on the mode selector and remote annunciator. In altitude hold mode, when the glideslope deviation indicator passes through the center dot, ALT ENG annunciation will also go off.

NOTE

●*The second glideslope connected to NAV 2 is an option and therefore must be installed to have normal glideslope operation in NAV 2 position of the mode selector.*

●*Glideslope will automatically engage only if NAV-LOC is engaged, course deviation bar displacement is half scale (1 dot) or less, course error is 25 degrees or less, and glideslope is armed. For manual glideslope engage, activate GS button when glideslope needle is nearly centered.*

●*Glideslope may be captured from above or below.*

●*Glideslope may be selected and will function in back course.*

●*With a NAV flag in view, the mode selector NAV green ENG and the mode repeater NAV annunciators will blink. With a GS flag in view, the mode selector GS green ENG and the mode repeater GS annunciators will blink; the autopilot will remain engaged. If only a GS flag is in view, the autopilot may continue to be used by disengaging the glideslope mode by activating the mode selector GS button or rotating the pitch command wheel, to return pitch control to the pitch command wheel. ILS/localizer coupling should be disengaged upon receiving a NAV flag.*

NOTE

Propellers full forward because prop modulation may affect glideslope reception at lower RPMs.

10. Propeller Control Levers - FORWARD prior to the outer marker.
11. Landing Gear.
 - a. Front Course Approach - DOWN at the outer marker if both engines operative.
 - b. Back Course Approach - DOWN 5 or 6 miles from touchdown if both engines operative.
12. Wing Flaps - APPR.
13. Airspeed - Maintain 120 to 140 KIAS.

NOTE

Verify autopilot roll trim indicator is neutral after final configuration is complete. Retrim as required.

14. Landing Gear - DOWN within gliding distance of field, if engine inoperative landing.
15. AP/TRIM DISC Switch - DISCONNECT (at decision height or by 200 feet above ground level).
16. Wing Flaps - LAND when landing is assured.

DISENGAGEMENT (ILS)

1. Navigation Mode Selector Button - ACTUATE. (Or)
2. Turn Command Knob - ROTATE. (Or)
3. Heading Mode Selector Button - ACTUATE.

NOTE

● *Complete autopilot disconnect should normally be conducted at the appropriate minimums with the pilot's control wheel AP/TRIM DISC switch.*

● *If an engine failure should occur, disconnect the autopilot, retrim, then reengage autopilot as required.*

SECTION 5 - PERFORMANCE

Not Applicable.

HORIZONTAL SITUATION INDICATOR (CS-832B)**SECTION 1 - GENERAL**

This supplement provides information which must be observed when operating the horizontal situation indicator (HSI).

Description

The CS-832B Horizontal Situation Indicator (HSI) is an additional navigation indicator option which provides a gyro stabilized magnetic compass information on a dial which rotates with the airplane through-out 360 degrees. The azimuth ring is graduated in 5 degree increments. Reference bug is positioned on the rotating heading dial by the heading knob to select and display preselected compass heading. A pictorial presentation of the airplane position in relation to selected VOR and localizer courses.

This indicator may be used with the 400 NAV/COM radio. When dual NAV/COM radios are installed, the HSI is coupled to the number 1 NAV/COM and a standard course deviation indicator (CDI) is coupled to the number 2 NAV/COM.

SECTION 2 - LIMITATIONS

Not Applicable.

SECTION 3 - EMERGENCY PROCEDURES

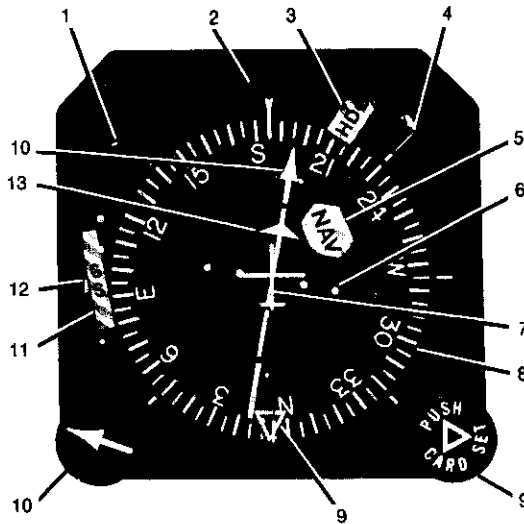
Not Applicable.

SECTION 4 - NORMAL PROCEDURES

Not Applicable.

SECTION 5 - PERFORMANCE

Not Applicable.



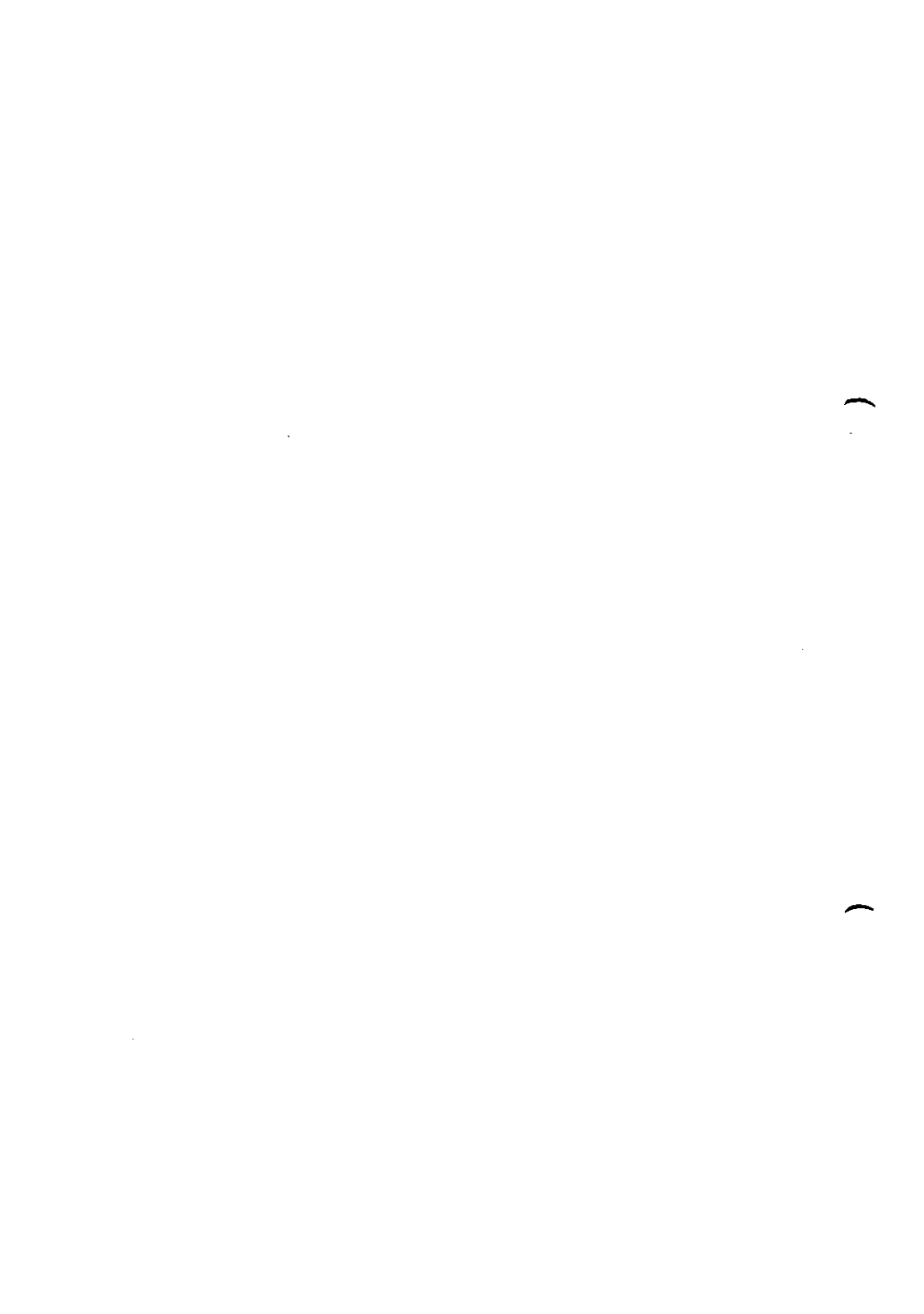
5914P6028

1. **HORIZONTAL SITUATION INDICATOR (HSI)** - Provides a pictorial presentation of the airplane position relative to NAV 1 VOR radials, localizer and glideslope beams. It also gives heading reference with respect to magnetic north and provides selection of desired heading, VOR radials and LOC runway heading as selected by NAV 1.
2. **HSI HEADING REFERENCE** - Indicates airplane heading on compass card.
3. **HSI HEADING FLAG** - Flag in view indicates the heading data is not reliable.
4. **HSI GYRO SLAVING INDICATOR** - Displays synchronization of compass card with respect to the magnetic flux detector unit. The heading selector knob may be used at any time to accomplish synchronization of the compass card reading with the magnetic heading as indicated by the slaving indicator. A slaved condition is present when the slaving indicator oscillates about the null point (45 degree fixed reference line on the HSI).
5. **HSI NAV FLAG** - Flag in view indicates the NAV 1 receiver signal being received is inadequate.

**Figure 1 (Sheet 1 of 2)
HORIZONTAL SITUATION INDICATOR**

6. **HSI COURSE DEVIATION DOTS** - Full scale course deviation bar displacement (2 dots) represents the following deviation from beam center; VOR ± 10 degrees, localizer approximately ± 2.5 degrees, RNAV en-route ± 5 nautical miles, RNAV approach ± 1.25 nautical miles.
7. **HSI COURSE DEVIATION BAR** - Displays displacement from the VOR, RNAV or localizer course center.
8. **HSI COMPASS CARD** - The compass card displays airplane heading. It is slaved to correct for normal precessional errors. Each graduation represents 5 degrees.
9. **HSI HEADING BUG AND HEADING SELECTOR KNOB** - Heading bug displays selected heading relative to the compass card. It is positioned by rotating the heading selector knob. The bug rotates with the compass card. Pushing in and rotating the knob sets the compass card.
10. **HSI COURSE CURSOR AND COURSE SELECTOR KNOB** - Course cursor is positioned on the compass card by rotating the course selector knob; this selects a VOR radial or LOC runway heading. It rotates with the compass card.
11. **HSI GLIDESLOPE FLAG** - Flag in view indicates the glideslope receiver signal is inadequate.
12. **HSI GLIDESLOPE POINTER, SCALE AND FLAG** - Displays deviation of airplane from an ILS glideslope. Flag obscures scale when the signal being received is not adequate. Full scale deflection of the glideslope pointer represents ± 0.7 degrees.
13. **HSI TO-FROM FLAG** - Indicates direction of the VOR station relative to the selected course. Displays TO when a LOC frequency is selected.

**Figure 1 (Sheet 2 of 2)
HORIZONTAL SITUATION INDICATOR**



1000A INTEGRATED FLIGHT CONTROL SYSTEM (IF-1050A)

SECTION 1 - GENERAL

This supplement provides information which must be observed when operating the 1000A Integrated Flight Control System.

Description

The 1000A Integrated Flight Control System (IFCS) is a two-axis autopilot system that controls the ailerons and elevators to maintain the airplane at a desired attitude. A yaw damper is also included in the system. The IFCS provides automatic flight control or manual control with precision flight direction provided by computer command information. The status of the system is displayed on the flight director indicator (FDI), the mode selector, the autopilot control panel, the horizontal situation indicator (HSI), and the autopilot mode repeater annunciators on the pilot's panel.

Operation of the flight director (FD) and automatic pilot (AP) system is basically the same. The difference is whether the pilot follows the flight director commands manually or allows the autopilot to fly the airplane.

Precision flight direction information for manual control is provided on the FDI, refer to Figure 4, by means of a symbolic airplane and pitch and roll command bar. The Flight Director Indicator consists of the instrument panel mounted indicator and a remote mounted electric vertical gyro mounted in the center right side of the nose baggage compartment. Normal gyro erection requires 3 minutes from initial activation. After initial activation, gyro erection rate is controlled by the V.G. ERECT switch, located below the horizontal situation indicator. The V.G. ERECT switch is spring loaded to the NORMAL position which provides an erection rate of 2.5 degrees per minute. If faster erection is desired, the switch can be held in the FAST position for an erection rate of 20 degrees per minute. The FAST position should only be used in level flight. The autopilot and/or flight director will disengage when the V.G. ERECT switch is in the FAST position. The flight director is automatically engaged when the autopilot is engaged, or it can be independently engaged by depressing the FD switch on the mode selector, refer to Figure 2.

A horizontal situation indicator (HSI), refer to Figure 3, displays a pictorial presentation of the airplane's position relative to VOR radials, localizer courses and glideslope beams. The HSI also gives heading reference with respect to magnetic north and provides for selection of the desired heading, VOR radial and LOC course.

For IFCS engagement, the autopilot/yaw damper switch on the autopilot control panel, refer to Figure 1, is placed in the AP/YD position. Pitch and turn manual command controls are located on this control panel. All other modes of flight are controlled from the mode selector.

The autopilot/yaw damper switch, when in the AP/YD position, also energizes the yaw damper system which functions independently of the autopilot or flight director. The yaw damper can be independently engaged by placing the AP/YD switch in the YD position.

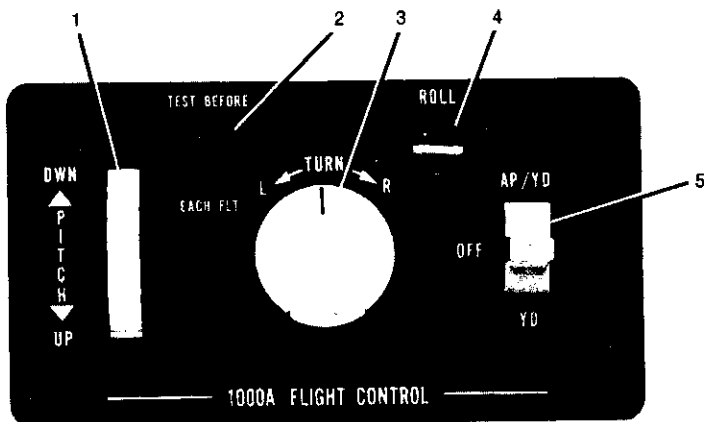
A disconnect function is provided to automatically disconnect the autopilot any time the airplane pitch attitude exceeds approximately 20 degrees up or down. The operational capability of the disconnect function should be tested before takeoff by pressing the TEST BEFORE EACH FLT button, located on the autopilot control panel. When the test button is pressed with the autopilot engaged, a test voltage is inserted into the attitude monitor circuitry, causing autopilot disconnect. This button must not be pressed in flight; it is for ground check only.

The pilot's control wheel, refer to Figure 5, incorporates switches for IFCS related operations. An electric elevator trim switch and an autopilot/electric elevator trim (AP/TRIM DISC) disconnect switch are provided on the pilot's left control horn. The pilot's right control horn incorporates a pitch synchronization button. Flight director go-around mode is initiated by pressing the GA button located on the left power lever.

The autopilot off (AP OFF) light, located adjacent to the flight director indicator, will illuminate when the autopilot is disconnected by any means other than the control wheel AP/TRIM DISC switch. The AP OFF light will remain on until it is cancelled by pressing the control wheel AP/TRIM DISC switch. When the GA button is pressed, the autopilot is disconnected and the flight director displays a 6 degrees pitch up command. Any time the autopilot disconnects, the disconnect horn will produce a short tone lasting 1 to 2 seconds with decreasing amplitude.

INTEGRATED FLIGHT CONTROL SYSTEM AIR DATA STATIC SYSTEM

The Integrated Flight Control System air data system provides an accurate pitot air and static air reference for the Integrated Flight Control System. The system consists of the air data computer which is located on the aft side of the aft pressure bulkhead, appropriate plumbing and the copilot's heated pitot-static system. Pitot-static heat is controlled by the R PITOT/STATIC switch located on the aft side console.



5914P6013

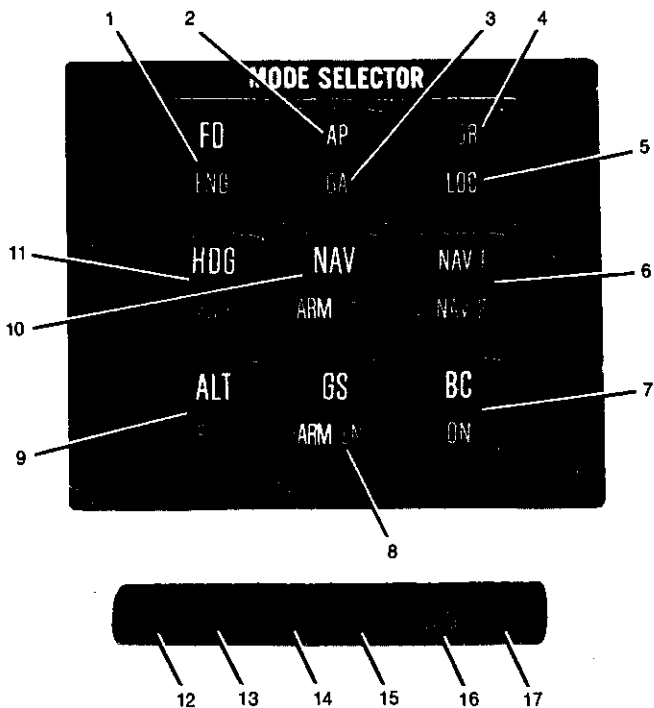
1. **PITCH COMMAND WHEEL** - Controls pitch attitude of the airplane. When rotated, commands pitch up or down. Pitch attitude change is proportional to the amount of rotation of the pitch command wheel. Rotation of the wheel disengages the ALT ENG or GS ENG modes. Rotation of the wheel does not affect GS ARM mode.
2. **TEST BEFORE EACH FLT BUTTON** - Pressing this switch with the autopilot engaged, tests the pitch attitude monitor circuitry, causing autopilot disconnect.
3. **TURN COMMAND KNOB** - Must be centered for FD or AP engagement. Commands roll attitude proportional to control rotation. Maximum command is nominally 25 degrees roll attitude. Disabled in GA mode. Rotation out of detent disengages HDG or NAV modes.
4. **ROLL TRIM INDICATOR** - Indicates direction of autopilot roll effort. Continuous deflection in either direction during steady flight indicates that manual adjustment of the airplane aileron trim is required in the same direction. Indicator is active with autopilot and/or flight director engaged or disconnected.

**Figure 1 (Sheet 1 of 2)
AUTOPILOT CONTROL PANEL**

5. AUTOPILOT/YAW DAMPER

SWITCH - Magnetically held three-position switch. In the center position, the system is off. Placing the switch in the AP/YD position engages the autopilot, yaw damper and flight director. The AP and FD annunciators on the mode selector will light, and the yaw damper flag on the turn and bank indicator will be pulled out of view. In the YD position, only the yaw damper system is engaged.

Figure 1 (Sheet 2 of 2)
AUTOPILOT CONTROL PANEL



5714P6016
5984P6005

1. FLIGHT DIRECTOR (FD) MODE SWITCH/ANNUNCIATOR - Momentary switch engages or disconnects the flight director. ENG annunciates green when mode is engaged.
2. AUTOPILOT (AP) ANNUNCIATOR LIGHT - AP annunciates green when autopilot is engaged.

Figure 2 (Sheet 1 of 4)
MODE SELECTOR AND MODE REPEATER ANNUNCIATORS

3. GO-AROUND (GA) ANNUNCIATOR LIGHT - GA annunciates green when go-around mode is engaged.
4. VOR ANNUNCIATOR LIGHT - VOR annunciates green when selected NAV receiver is tuned to VOR frequency.
5. LOC ANNUNCIATOR LIGHT - LOC annunciates green when selected NAV receiver is tuned to localizer frequency.
6. NAV 1/NAV 2 SWITCH/ANNUNCIATOR - Alternate action manual switch that selects NAV 1 or NAV 2 navigation system for coupling to IFCS. Appropriate segment annunciates green when selected.
7. BACK COURSE (BC/ON) SWITCH/ANNUNCIATOR - Momentary switch selects back course mode independent of IFCS engagement, if selected NAV is tuned to a localizer frequency. If NAV 1 is selected, and both NAV's are tuned to localizer frequencies, the CDI display reverses on NAV 2 non-HSI type indicators. BC annunciates green when mode is selected.
8. GLIDESLOPE (GS) SWITCH/ANNUNCIATOR - Momentary alternate action switch arms glideslope mode if selected navigation receiver is tuned to a localizer frequency and NAV mode is armed or engaged. ARM will announce amber when glideslope is armed. Depressing the switch again will disengage ARM mode. The ENG annunciator will illuminate green when the glideslope is captured. Depressing the switch again will disengage ENG mode. ENG blinks when the selected glideslope receiver is in an alarm condition; FDI command bars are pulled out of sight; glideslope remains coupled to the autopilot. Glideslope will arm and engage with front or back course selected.
9. ALTITUDE (ALT) MODE SWITCH/ANNUNCIATOR - Momentary switch engages or disengages altitude hold mode. ENG annunciates green when mode is engaged.

Figure 2 (Sheet 2 of 4)
MODE SELECTOR AND MODE REPEATER ANNUNCIATORS

10. NAV MODE SWITCH/
ANNUNCIATOR - Momentary activation engages or disengages NAV ARM or the NAV ENG mode, dependent on HDG mode status and position of the airplane relative to the beam center. If HDG mode is not engaged, NAV mode will engage immediately and be annunciated by ENG lighting green. The airplane will turn to intercept the beam at a fixed intercept angle. If HDG mode is engaged, and beam displacement is greater than a preset amount on the course deviation indicator, (one fifth scale for VOR enroute, full scale for VOR with wing flaps at T.O. or more selected, and full scale for localizer operation), the HDG mode will remain engaged and the NAV mode will arm. An amber ARM annunciation will appear below the white NAV. The airplane will continue on the selected heading until the beam displacement decreases to less than the preset amount, at which time NAV mode will automatically engage and HDG mode will disengage. The ARM annunciation will also extinguish and the ENG annunciation will light green. The airplane will then turn to capture the beam. ENG blinks when the selected NAV receiver is in a flag alarm condition. However, NAV remains coupled to the IFCS. FDI pitch and roll command bars will remain in sight in VOR mode, but are pulled out of sight in LOC mode in the flag alarm condition.
11. HEADING (HDG) MODE SWITCH/
ANNUNCIATOR - Momentary switch engages or disengages the heading mode. ENG annunciates green when mode is engaged. Heading mode engagement will cancel NAV and GA modes.

NOTE

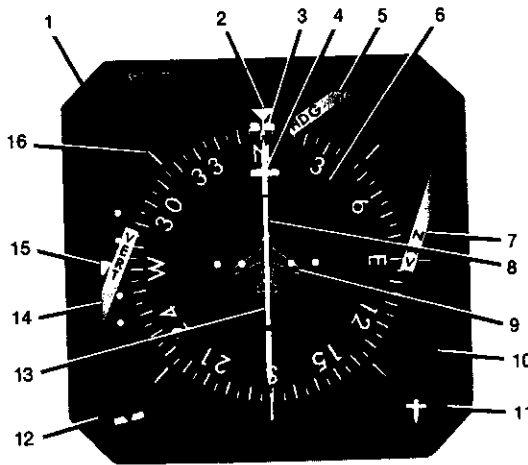
The HDG, NAV, ALT, GS, and BC push buttons are illuminated white on the mode selector. With the MASTER LIGHTING switch in the NIGHT position, the intensity of the lights on the MODE SELECTOR and MODE REPEATER is controlled by the RADIO PANEL LIGHT INTENSITY CONTROL.

**Figure 2 (Sheet 3 of 4)
MODE SELECTOR AND MODE REPEATER ANNUNCIATORS**

MODE REPEATER ANNUNCIATORS

- 12. HDG ANNUNCIATOR - Indicates IFCS is engaged in heading mode.
- 13. NAV ANNUNCIATOR - Indicates IFCS is engaged in navigation mode.
- 14. BC ANNUNCIATOR - Indicates back course is selected.
- 15. ALT ANNUNCIATOR - Indicates IFCS is engaged in ALT mode.
- 16. GS ARM ANNUNCIATOR - Indicates IFCS is in glideslope ARM mode.
- 17. GS ANNUNCIATOR - Indicates IFCS is engaged in glideslope mode.

**Figure 2 (Sheet 4 of 4)
MODE SELECTOR AND MODE REPEATER ANNUNCIATORS**



5985P6001

- 1. **HORIZONTAL SITUATION INDICATOR (HSI)** - The HSI combines numerous displays to provide a presentation of the airplane's position. The indicator displays airplane's displacement relative to VOR, localizer, and glideslope beam, and heading with respect to magnetic north.
- 2. **HEADING REFERENCE INDEX** - The heading reference index indicates airplane heading on compass card.

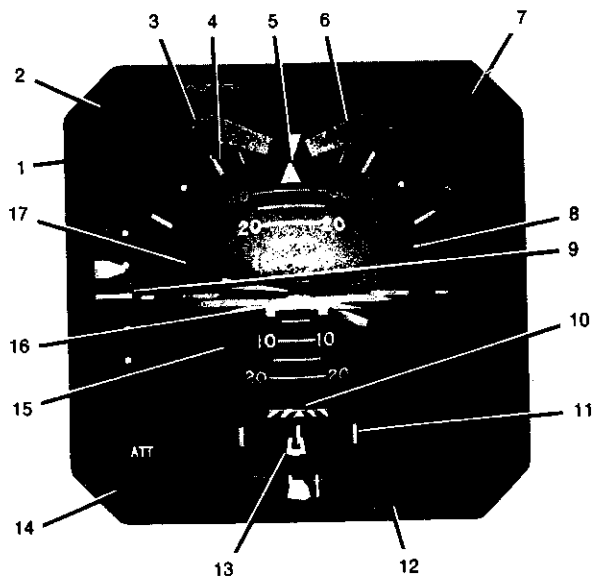
**Figure 3 (Sheet 1 of 3)
HORIZONTAL SITUATION INDICATOR**

3. **HEADING**
BUG - The heading bug is positioned on the rotating compass card by the heading knob and displays preselected compass heading. The bug rotates with the heading dial so the difference between the bug and the heading reference index is the amount of heading error applied to the flight director computer. In the heading mode the ADI will display the proper bank commands to turn to and maintain this selected heading.
4. **COURSE**
POINTER - The course pointer is positioned on the compass card by the course knob to select a magnetic bearing that coincides with the desired VOR radial or localizer course. The course pointer rotates with the compass card to provide a continuous readout of course error to the computer.
5. **HEADING WARNING**
FLAG - Indicates vertical gyro or heading indicator failure.
6. **COMPASS**
CARD - The compass card, graduated in 5 degree increments, provides airplane magnetic heading reference. The compass card is slaved to provide for precessional errors.
7. **NAVIGATION WARNING**
FLAG - Indicates failure of NAV radio select on FD mode selector or unreliable NAV radio signal.
8. **TO/FROM INDICATOR** - Indicates direction of the VOR station relative to the selected course (not illuminated).
9. **SYMBOLIC AIRPLANE** - Provides a pictorial presentation of the airplane position and intercept angle relative to a selected VOR radial or localizer course.
10. **COMPASS SYNCHRONIZATION**
ANNUNCIATOR - When the compass system is in the slaved mode, the display will oscillate between a ● and + indicating the compass card is synchronized with gyro stabilized magnetic heading.
11. **COURSE KNOB** - The course knob is used to position the course pointer on the compass card.
12. **HEADING KNOB** - The heading knob is used to position the heading bug on the compass card.
13. **COURSE DEVIATION BAR** - The course deviation bar represents the center line of the selected VOR or localizer course.

Figure 3 (Sheet 2 of 3)
HORIZONTAL SITUATION INDICATOR

- 14. **VERTICAL WARNING FLAG** - Indicates failure of vertical navigation system (if V NAV mode selected), unreliable glideslope signal, or glideslope failure, if localizer frequency tuned on NAV radio.
- 15. **GLIDESLOPE POINTER** - The glideslope pointer displays glideslope deviation. The pointer is only visible when tuned to a localizer frequency. The glideslope pointer will also display V NAV deviation.
- 16. **AZIMUTH MARK** - The azimuth mark is fixed at plus or minus 45 degrees from the heading reference index.

**Figure 3 (Sheet 3 of 3)
HORIZONTAL SITUATION INDICATOR**



5914P6029

- 1. **FLIGHT DIRECTOR INDICATOR (FDI)** - Displays airplane attitude as a conventional attitude gyro and displays commands for flight director operation.

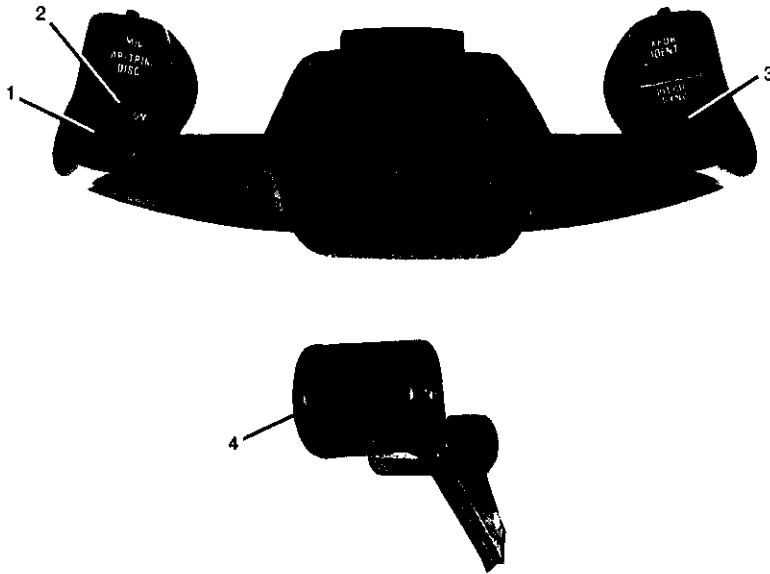
**Figure 4 (Sheet 1 of 3)
FLIGHT DIRECTOR INDICATOR**

2. **FDI GO-AROUND (GA) ANNUNCIATOR** - Indicates pilot has selected Go-Around Mode on flight director.
3. **FLIGHT DIRECTOR (FD) WARNING FLAG** - Flag in view indicates command bar data is not reliable.
4. **FDI ROLL ATTITUDE SCALE** - Scale with 0, 10, 20, 30, 45, 60 and 90 degrees marks, indicated with respect to roll attitude index.
5. **FDI ROLL ATTITUDE INDEX** - Displays airplane roll attitude against the roll attitude scale.
6. **ATTITUDE (ATT) WARNING FLAG** - Flag in view indicates attitude gyro data is not reliable.
7. **FDI DECISION HEIGHT (DH) ANNUNCIATOR** - Indicates airplane has reached preset decision height selected on the optional radio altimeter.
8. **FDI ATTITUDE SPHERE** - Moves with respect to symbolic airplane to display airplane pitch and roll attitude.
9. **FDI GLIDESLOPE POINTER** - When in view, indicates deviation from glideslope.
10. **FDI RISING RUNWAY** - (Applicable only with optional radio altimeter.) Bar comes into view at approximately 200 feet altitude and rises with descending altitude. Bar touches airplane symbol at touchdown.
11. **FDI EXPANDED LOCALIZER SCALE** - Scale consists of 3 vertical marks. The center mark represents the localizer course center line. The right and left marks indicate approximately 13 percent of full scale localizer deviation on an HSI or course deviation indicator.
12. **FDI INCLINOMETER** - Indicates slip to the left or right by displacement of the ball.
13. **FDI EXPANDED LOCALIZER INDICATOR** - Indicates deviation from localizer course center line.

**Figure 4 (Sheet 2 of 3)
FLIGHT DIRECTOR INDICATOR**

14. ATTITUDE (ATT) TEST SWITCH - When pressed, the normal response is a 10 degrees pitch up and 20 degrees right roll of the symbolic airplane and presentation of the ATT flag.
15. FDI PITCH ATTITUDE SCALE - Movable scale with 5 degrees thru 40 degrees marks referenced against the symbolic airplane.
16. FDI SYMBOLIC AIRPLANE - Airplane attitude is displayed by the relationship between the fixed symbolic airplane and the movable background. The symbolic airplane is normally aligned with the attitude sphere horizon line for normal cruise attitude. During flight director operation, the symbolic airplane is flown to align it with the command bars to satisfy the flight director commands.
17. FDI COMMAND BAR - The single cue pitch and roll command bar displays computed steering commands referenced to the symbolic airplane to intercept and maintain a desired flight path. The command bar is retracted when the flight director is not engaged.
18. VG ERECT SWITCH - Controls erection rate of the remotely mounted electric vertical gyro. Switch is spring-loaded to the NORMAL position which provides a maximum erection time of three minutes. If a faster erection rate is desired, the switch can be held in the FAST position. The fast position should only be used in level flight. The autopilot and/or flight director will disconnect when the switch is in the FAST position. During initial erection, the system is in fast erect regardless of switch position.

Figure 4 (Sheet 3 of 3)
FLIGHT DIRECTOR INDICATOR

6085P6012
5714P6030**1. ELECTRIC ELEVATOR**

TRIM SWITCH - When moved forward to the DN position, the elevator trim tab moves in the nose-down direction; conversely, moving the switch aft to the UP position moves the tab in the nose-up direction. Operation of the electric trim switch, when the autopilot/yaw damper switch is in AP/YD position, disconnects IFCS and yaw damper. A short (1 to 2 second) decreasing tone is heard and the AP OFF annunciator lights. When the autopilot/yaw damper switch is in the YD position, operation of the electric trim switch has no effect on the yaw damper.

2. AUTOPILOT/ELECTRIC ELEVATOR

TRIM (AP/TRIM) DISCONNECT SWITCH (RED) - Disconnects the IFCS and/or yaw damper. A short (1 to 2 second) tone with decreasing amplitude is heard in the cockpit when the autopilot disconnects. No tone will be heard when disconnecting the yaw damper only. Disables electric trim if a fault exists in the electric trim. Operation cancels AP OFF light, if illuminated.

Figure 5 (Sheet 1 of 2)**CONTROL WHEEL AND POWER LEVER CONTROLS**

3. PITCH SYNCHRONIZATION

BUTTON - Upon IFCS engagement, the pitch axis is instantaneously synchronized to the existing pitch attitude. If desired, with IFCS engaged, the airplane can be manually flown to a new pitch attitude by keeping the pitch synchronization button depressed. Depressing the button also disengages the altitude hold mode. Pitch synchronization is inhibited when glideslope or go-around is engaged.

4. **GO-AROUND (GA) SWITCH** - When pressed, the flight director GA mode is engaged. The GA annunciator on the mode selector will light; all other modes are cancelled and the autopilot is disconnected. The GA mode provides a preset pitch-up and a wings-level command. With GA mode engaged, repressing the GA switch, selecting the HDG mode, or reengaging the autopilot will cancel the GA mode.

Figure 5 (Sheet 2 of 2)
CONTROL WHEEL AND POWER LEVER CONTROLS

SECTION 2 - LIMITATIONS**AUTOPILOT:**

1. Autopilot and yaw damper must be off for takeoff and landing.
2. Approach VOR radial at an angle of 135 degrees or less prior to engaging the navigation mode.
3. Approach localizer at an angle of 90 degrees or less prior to engaging the navigation mode.
4. Disconnect autopilot if malfunction occurs.
5. Minimum speed for autopilot operation is 120 KIAS.
6. Maximum speed for autopilot operation is 229 KIAS/0.52 Mach, V_{MO}/M_{MO} .
7. Do not use IFCS below 200 feet above ground level in approach.
8. Do not use IFCS below 500 feet above ground level during enroute operations.
9. Do not engage altitude hold mode with vertical speed above 1500 feet per minute.
10. Fuel must remain balanced for all autopilot operations.

SECTION 3 - EMERGENCY PROCEDURES

ELECTRIC ELEVATOR TRIM RUNAWAY

1. **Control Wheel - OVERPOWER as required.**
2. **AP/TRIM DISC Switch - DISCONNECT immediately.**
3. **Manual Elevator Trim - AS REQUIRED.**

NOTE

After the electric trim has been disconnected and the emergency is over, pull the electric trim (ELEV TRIM) circuit breaker. Do not attempt to use the electric elevator trim system until ground maintenance has been completed.

AUTOPILOT EMERGENCIES

AUTOPILOT MALFUNCTION

1. **Elevator or Aileron Control - OVERPOWER as required.**
1. **AP/TRIM DISC Switch - DISCONNECT immediately.**

NOTE

●*If autopilot malfunctions, the possible altitude loss (includes altitude loss prior to pilot recognition) for cruise, climb, descent configuration and maneuvering flight is 500 feet. For approach configuration, the altitude loss is 120 feet.*

●*After the autopilot has been disconnected and the emergency is over, pull the roll and pitch actuator (ACT) circuit breaker. Do not attempt to use the autopilot until ground maintenance has been completed.*

ENGINE FAILURE

1. Aircraft - CONTROL as required.
2. Inoperative Engine Propeller - FEATHER.
3. AP/TRIM DISC Switch - DISCONNECT.
4. Operative Engine - INCREASE POWER, as required.
5. Landing Gear - UP.
6. Wing Flaps - UP or as required.
7. Trim Tabs - ADJUST.
8. Inoperative Engine - SECURE.

ENGINE INOPERATIVE COUPLED APPROACH

1. Fuel - BALANCED.
2. Trim Tabs - ADJUST.
3. Autopilot - ENGAGE per VOR, ILS/Localizer Coupling Procedure.

4. Engine Inoperative Landing Checklist - COMPLETED.

SECTION 4 - NORMAL PROCEDURES**ELECTRIC ELEVATOR TRIM DISCONNECT CHECK**

1. Operate the electric trim switch in one direction and observe motion of the manual pitch trim wheel in the proper direction. While performing the above test, momentarily depress AP/TRIM DISC switch and release. Observe that manual pitch trim wheel motion is arrested and remains stopped when the disconnect switch is released and electric trim switch is activated.
2. Repeat Step 1. in the opposite direction.

AUTOPILOT ATTITUDE MONITOR DISENGAGE CHECK (WITH GYRO ERECTED)**BEFORE TAKEOFF**

1. Turn Command Knob - CENTER DETENT.
2. Autopilot/Yaw Damper Switch - AP/YD. Observe annunciation on mode selector for AP and FD engage, and that the turn and bank yaw damper flag is retracted.
3. FD Mode Selector Button - ACTUATE. Observe FD disconnect.
4. TEST BEFORE EACH FLT Test Button - PUSH and HOLD.
5. Verify the following:
 - a. Autopilot/Yaw Damper Switch - OBSERVE return to OFF position.
 - b. AP OFF Light - OBSERVE illumination.
 - c. Autopilot Disconnect Horn - OBSERVE 1 to 2 second decreasing aural tone.
6. AP/TRIM DISC Switch - PUSH to turn off the AP OFF light.
7. Autopilot Yaw Damper Switch - AP/YD - OBSERVE annunciation.
8. Left Power Lever GA Switch - PRESS.
9. Verify the following:
 - a. Autopilot/Yaw Damper Switch - OBSERVE return to OFF position.
 - b. AP OFF Light - OBSERVE illumination.
 - c. Autopilot Disconnect Horn - OBSERVE 1 to 2 second decreasing aural tone.
 - d. FD GA Light - OBSERVE illumination.
 - e. Flight Director Command Bars - CHECK for wings level pitch up command.
10. FD Mode Selector Button - ACTUATE. Observe FD disconnect.
11. Left Power Lever GA Switch - PRESS.

12. Verify that flight director engages in GA mode.
13. FD Mode Selector Button - ACTUATE. Observe FD disconnect.

BASIC AUTOPILOT OPERATION (FLIGHT DIRECTOR ON OR OFF)

BEFORE ENGAGEMENT

1. Airplane Elevator, Aileron and Rudder Trim - ADJUST.

ENGAGEMENT

1. Turn Command Knob - CENTER DETENT.
2. Pitch Synchronization Button - If flight director engaged, MOMENTARILY PRESS to synchronize the flight director pitch command bar to the airplane attitude.
3. Autopilot/Yaw Damper Switch - AP/YD. OBSERVE AP annunciation.

NOTE

Airplane rudder trim will have to be adjusted as required for ball centered flight. Airplane aileron trim will have to be readjusted as indicated by the roll trim indicator on the autopilot control panel to compensate for large air-speed or configuration changes. Trim toward the roll trim indicator deflection.

TURN COMMANDS

1. Turn Command Knob - ROTATE as desired.

PITCH COMMANDS

1. Pitch Command Wheel - ROTATE as desired. (Or)
2. Pitch Synchronization Button - PRESS and HOLD. Manually place airplane at desired attitude, then release button.

DISCONNECT

1. AP/TRIM DISC Switch - DISCONNECT. (Or)
2. Autopilot/Yaw Damper Switch - OFF. (Or)
3. Left Power Lever Go-Around Switch - PRESS. Refer to Go-Around operation. (Or)
4. Pilot's Electric Elevator Trim Switch - ACTUATE.

NOTE

Normal autopilot disconnect should be conducted with the pilot's control wheel AP/TRIM DISC switch. The AP OFF light will not illuminate, but the autopilot disconnect horn will produce a short tone lasting 1 to 2 seconds with decreasing amplitude.

NOTE

● *If the autopilot disconnects by any means other than the activation of the pilot's control wheel AP/TRIM DISC switch, the AP OFF light will continuously illuminate and the autopilot disconnect horn will produce a short tone lasting 1 to 2 seconds with decreasing amplitude. The AP OFF light may be extinguished by cycling the pilot's control wheel AP/TRIM DISC switch.*

● *Autopilot disconnect with the left power lever go-around (GA) switch will illuminate the AP OFF light and the autopilot disconnect horn will produce a short tone lasting 1 to 2 seconds with decreasing amplitude. Refer to Go-Around Operation.*

ALTITUDE HOLD (FLIGHT DIRECTOR AND/OR AUTOPILOT MODES)

ENGAGEMENT

CAUTION

DO NOT OPERATE THE AUTOPILOT IN ALTITUDE HOLD MODE WHEN FLYING IN MODERATE TO SEVERE TURBULENCE, MOUNTAIN LEE WAVE ACTIVITY AND/OR MODERATE TO SEVERE ICING CONDITIONS.

NOTE

To obtain smooth altitude captures, decrease vertical speed to 1500 feet per minute or less and decrease airplane pitch attitude to within 5 degrees of level when approaching desired altitude.

1. With Basic IFCS:
 - a. Altitude Hold Mode Selector Button - PRESS at desired altitude. Observe annunciation.
2. With Optional Altitude Alert/Preselect System:
 - a. Desired Altitude - SELECT.
 - b. Altitude Alert/Preselect Arm Button - PUSH. Observe that amber ARMD light illuminates.

NOTE

The altitude alert/preselect ARMD mode is inoperative when the IFCS is in the altitude hold or glideslope mode. Once armed, the altitude alert/preselect mode can be disarmed by reselecting a different altitude on the altitude preselect presentation, by selecting the altitude hold mode on the mode selector or by glideslope capture.

- c. Pitch Command Wheel - UP or DOWN as required to intercept selected altitude.
- d. When selected altitude is captured, OBSERVE:
 - (1) Altitude alert/preselect amber ARMD light goes OFF.
 - (2) Altitude alert/preselect green CPLD light illuminates.
 - (3) Mode selector ALT ENG annunciator illuminates green.
 - (4) Remote Annunciator ALT illuminates.

NOTE

After engagement, and when the airplane has transitioned to level flight, the altitude hold mode may maintain the airplane at an altitude slightly above or below the selected altitude. If the altitude difference is objectional, disengage the altitude hold mode and acquire the desired altitude, either by using the pitch command wheel, or by holding the pitch synchronization button and manually pitching the airplane until the desired indicated altitude is reached. Then reengage altitude hold mode.

DISENGAGEMENT

1. Altitude Hold Mode Selector Button - ACTUATE. (Or)
2. Pitch Synchronization Button - PRESS. (Or)
3. Pitch Command Wheel - ROTATE.

NOTE

Altitude hold mode will automatically disengage in the coupled ILS mode when the glideslope is engaged.

HEADING SELECT FUNCTION**ENGAGEMENT**

1. Turn Command Knob - CENTER DETENT.
2. HSI Heading Selector Knob - ROTATE bug to desired magnetic heading.
3. Heading Mode Selector Button - ACTUATE. Observe annunciation.
4. Remote Annunciator HDG illuminates.
5. HSI Heading Selector Knob - ADJUST for any subsequent desired heading changes.

NOTE

When an optional copilot's horizontal situation indicator is installed and connected to the autopilot, the pilot's heading bug controls the heading when NAV 1 receiver is selected by the mode selector NAV 1/NAV 2 switch, and the copilot's heading bug controls heading when NAV 2 receiver is selected. When a copilot's directional gyro is installed, the pilot's heading bug controls the heading when NAV 1 or NAV 2 receivers are selected.

DISENGAGEMENT

1. Heading Mode Selector Button - ACTUATE. (Or)
2. Turn Command Knob - ROTATE. (Or)
3. Navigation Mode - AUTO ENGAGE.

VOR COUPLING**ENGAGEMENT (VOR)**

1. NAV 1/NAV 2 Mode Selector Button - SELECT NAV 1 or NAV 2. Observe proper annunciation (including VOR annunciator on mode selector).
2. Course Selector Knob - ADJUST to desired VOR course.

3. Wing Flaps - T.O. if VOR approach is desired.

NOTE

Wing Flaps must be positioned to T.O. or lower to obtain the VOR approach mode.

4. Airspeed - 120 to 160 KIAS for VOR approach.
5. Turn Command Knob - CENTER DETENT.
6. Navigation Mode Selection.
 - a. Variable Angle Intercept.
 - (1) HSI Heading Selector
Knob - ROTATE bug to the desired heading (within 135 degrees of desired VOR course).
 - (2) Heading Mode Selector
Button -PRESS. Observe ENG green annunciation on mode selector and HDG on remote annunciator.
 - (3) Navigation Mode Selector
Button - PRESS. Observe annunciation of NAV ARM on mode selector. Airplane will continue flying selected heading until the course deviation indicator moves off the peg in the VOR approach mode or half scale in the VOR enroute mode. HDG green ENG and NAV amber ARM annunciators on the mode selector and HDG on remote annunciator will then go out and NAV green ENG annunciator and remote annunciator NAV will light to indicate engagement.

NOTE

With an intercept angle in HDG mode of less than 45 degrees at the time NAV engage occurs, the airplane will initially turn toward the track and establish a 45 degrees intercept angle followed by a turn in the opposite direction to the heading required for a smooth intercept. With the intercept angle in HDG mode greater than 45 degrees, the airplane will initially turn to the heading required for a 45 degrees intercept.

- b. Fixed Angle Intercept.
 - (1) Heading Mode - DISENGAGE (if engaged).
 - (2) Maneuver the airplane to within 135 degrees of the desired VOR course.
 - (3) Navigation Mode
Selector Button - ACTUATE. Observe NAV green ENG annunciation on mode selector and NAV on remote annunciator. Airplane will turn to intercept the VOR beam at 45 degrees intercept angle.

7. Propeller Control Levers - FORWARD prior to final fix inbound.
8. Landing Gear - DOWN at final fix if both engines operating.
9. Wing Flaps - APPR.
10. Airspeed - 120 to 140 KIAS.

NOTE

Verify roll trim indicator is neutral after final configuration is complete. Readjust aileron trim tab as required.

11. Landing Gear - DOWN within gliding distance of field if engine inoperative landing.
12. AP/TRIM DISC Switch - DISCONNECT at minimum descent altitude.
13. Wing Flaps - LAND when landing is assured.

DISENGAGEMENT (VOR)

1. Navigation Mode Selector Button - ACTUATE. (Or)
2. Turn Command Knob - ROTATE. (Or)
3. Heading Mode Selector Button - ACTUATE.

NOTE

Complete autopilot disconnect should normally be conducted on a VOR approach at the appropriate minimums or by 200 feet above ground level with the pilot's control wheel AP/TRIM DISC switch.

ILS/LOCALIZER COUPLING**ENGAGEMENT (ILS)**

1. NAV 1/NAV 2 MODE
Selector Button - SELECT NAV 1 or NAV 2, observe proper annunciation on mode selector. Observe LOC annunciation on mode selector.
2. Course Selector Knob - ADJUST to localizer front course bearing for both front and back course approaches.
3. Back Course Mode
Selector Button - ACTUATE as applicable. Observe BC green ON annunciation on mode selector and on the remote annunciator.
4. Wing Flaps - T.O.
5. Airspeed - 120 to 160 KIAS.
6. Turn Command Knob - CENTER DETENT.

7. Altitude Hold Mode Selector Button - ACTUATE as appropriate if desired. Observe annunciation.
8. Navigation Mode Selection
 - a. Variable Angle Intercept.
 - (1) HSI Heading Selector Knob - ROTATE bug for radar vectors and/or 30 degrees to 90 degrees localizer intercept angle. Intercept localizer before the outer marker.
 - (2) Heading Mode Selector Button - ACTUATE. Observe annunciation.
 - (3) Navigation Selector Button - ACTUATE. Observe annunciation of NAV ARM on mode selector. Airplane will continue flying selected heading until the course deviation indicator moves off the peg. HDG green ENG and NAV amber ARM annunciators on mode selector will then go off and NAV green ENG annunciator and NAV on remote annunciator will light, indicating NAV engagement.

NOTE

With an intercept angle in HDG mode of less than 30 degrees at the time NAV engage occurs, the airplane will initially turn toward the track and establish a 30 degrees intercept angle followed by a turn in the opposite direction to the heading required for a smooth intercept. With the intercept angle in HDG mode greater than 30 degrees, the airplane will initially turn to the heading required for a 30 degrees intercept.

- b. Fixed Angle Intercept.
 - (1) Heading Mode - DISENGAGE if engaged.
 - (2) Maneuver airplane to within 90 degrees of localizer bearing.
 - (3) Navigation Mode Selector Button - ACTUATE. Observe NAV green ENG annunciation on mode selector and NAV on the remote annunciator. Airplane will turn to intercept the localizer beam at a 30 degrees intercept angle.
9. Glideslope Mode Selector Button - ACTUATE. Observe annunciation of GS ARM on mode selector and on the remote annunciator. Maneuver airplane to intercept the glideslope. GS green ENG annunciation will indicate glideslope engagement on the mode

selector and remote annunciator. In altitude hold mode, when the glideslope deviation indicator passes through the center dot, ALT ENG annunciation will also go off.

NOTE

- *The second glideslope connected to NAV 2 is an option and therefore must be installed to have normal glideslope operation in NAV 2 position of the mode selector.*
- *Glideslope will automatically engage only if NAV-LOC is engaged, course deviation bar displacement is half scale (1 dot) or less, course error is 25 degrees or less, and glideslope is armed. For manual glideslope engage, activate GS button when glideslope needle is nearly centered.*
- *With a NAV flag in view, the mode selector NAV green ENG and the mode repeater NAV annunciators will blink. With a GS flag in view, the mode selector GS green ENG and the mode repeater GS annunciators will blink. With flight director engaged in NAV (LOC) and glideslope modes, the NAV or GS flags, when in view for more than 3 seconds, will cause the flight director command bars to be retracted from view until the warning flag is subsequently retracted. The command bars will then automatically return in view. With the flight director engaged in NAV (VOR) mode, the flight director command bars will remain in view with a NAV flag in view.*
- *Glideslope may be captured from above or below.*
- *Glideslope may be selected and will function in back course.*
- *If the autopilot is engaged in NAV (LOC) and glideslope modes, the autopilot will remain engaged even though the flight director command bars have been pulled from view due to a NAV or GS flag. If only a GS flag is in view, the autopilot may continue to be used by disengaging the glideslope mode by actuating the mode selector GS button or the pitch command wheel, to return pitch control to the pitch command wheel.*

NOTE

● *ILS/localizer coupling should be disengaged upon receiving a NAV flag.*

● *Propellers full forward because prop modulation may affect glideslope reception at lower RPMs.*

10. Propeller Control Levers - FORWARD prior to the outer marker.
11. Landing Gear.
 - a. Front Course Approach - DOWN at the outer marker if both engines operative.
 - b. Back Course Approach - DOWN 5 or 6 miles from touchdown if both engines operative.
12. Wing Flaps - APPR.
13. Airspeed - Maintain 120 to 140 KIAS.

NOTE

Verify autopilot roll trim indicator is neutral after final configuration is complete. Retrim as required.

14. Landing Gear - DOWN within gliding distance of field, if engine inoperative landing.
15. AP/TRIM DISC Switch - DISCONNECT (at decision height or by 200 feet above ground level).
16. Wing Flaps - LAND when landing is assured.

DISENGAGEMENT (ILS)

1. Navigation Mode Selector Button - ACTUATE. (Or)
2. Turn Command Knob - ROTATE. (Or)
3. Heading Mode Selector Button - ACTUATE.

NOTE

● *Complete autopilot disconnect should normally be conducted at the appropriate minimums with the pilot's control wheel AP/TRIM DISC switch.*

● *If an engine failure should occur, disconnect the autopilot, retrim, then reengage autopilot as required.*

GO-AROUND OPERATION**ENGAGEMENT (GO-AROUND)**

1. Left Power Lever
Go-Around Switch - **PRESS**. Observe GA and FD annunciation on mode selector if not already engaged.

NOTE

The go-around mode gives a wings-level pitch up command (6 degrees nose up) on the flight director indicator. Actuation of go-around mode disconnects the autopilot, if engaged.

DISENGAGEMENT (GO-AROUND)

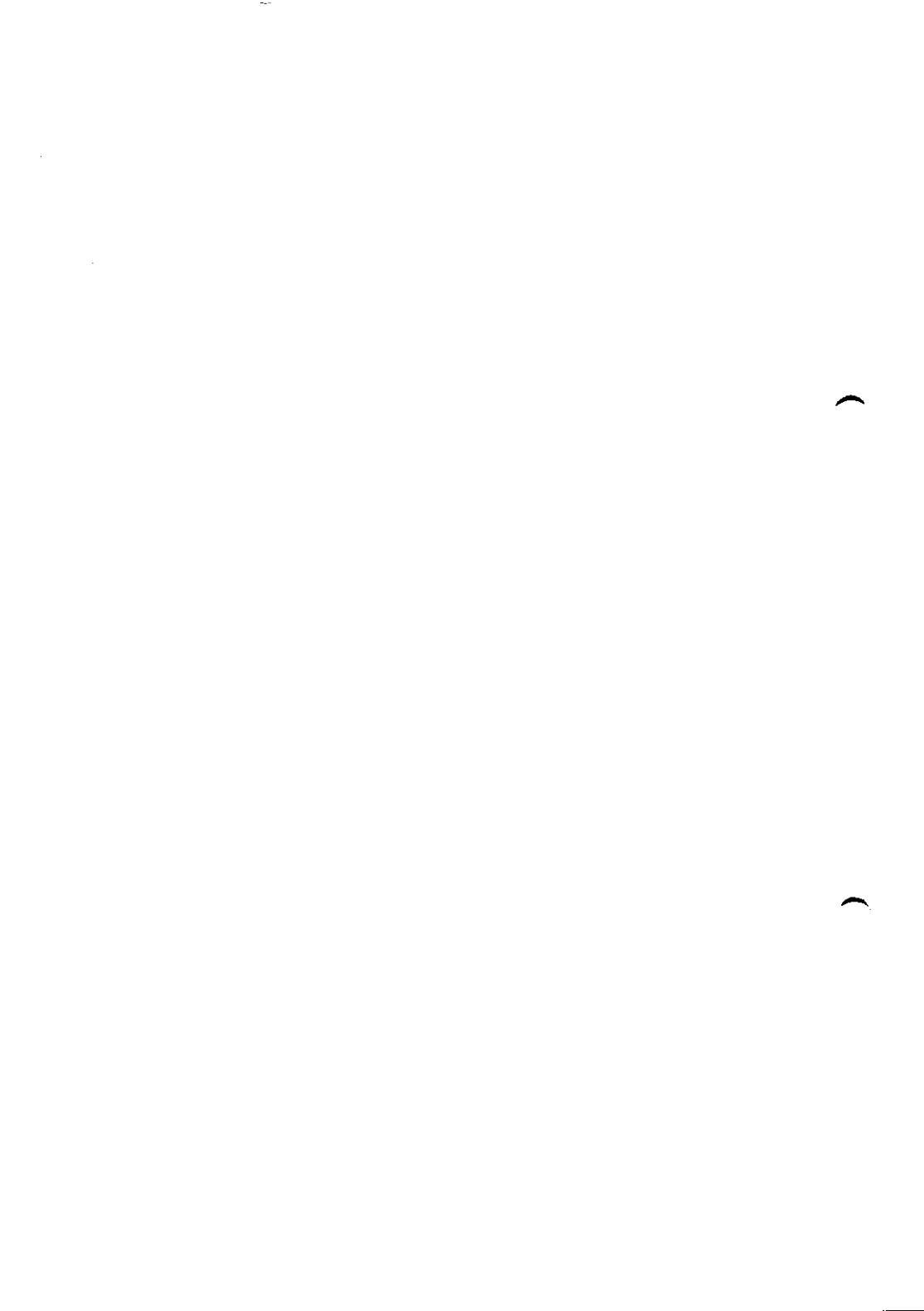
1. Left Power Lever Go-Around Switch - **PRESS**. (Or)
2. Heading Mode Selector Button - **ACTUATE**. (Or)
3. Autopilot/Yaw Damper Switch - **AP/YD**.

NOTE

The airplane should be manually retrimmed to the flight director attitude before reengaging the autopilot to avoid an abrupt pitch change as the autopilot tries to satisfy the existing pitch command.

SECTION 5 - PERFORMANCE

Not Applicable.



NAVIGATION SYSTEM (PN-101)**SECTION 1 - GENERAL**

This supplement provides information which must be observed when operating the PN-101 Navigation System.

Description

The Collins PN-101 Navigation System consists of a horizontal situation indicator (HSI) mounted on the instrument panel and a remotely-located slaved directional gyro, flux detector and slaving accessory unit. The PN-101 also contains its own inverter. The indicator unit combines a compass card, VOR/localizer/course deviation indicator, warning flags and TO-FROM indicator arrows. The heading knob (HDG) positions a moveable heading index while the course knob is used to set the course indicator. A lubber line and 45 degrees index marks facilitate course intercept. The directional gyro, in conjunction with the flux detector and slaving accessory unit, supplies magnetic heading information to the PN-101 and the pilot's RMI. A glideslope indicator is located on the left side of the instrument.

Two different types of DG SLAVE switch panels are provided, depending on the type of equipment installed. If Sperry equipment is installed the AUTO switch allows selection of slaved (NORM) or unslaved (OFF) operation. The MAN switch allows the compass card to be moved clockwise or counterclockwise manually. If Collins optional equipment is installed a different panel is provided. The MAN switch operation is identical with that of the Sperry equipment, however, the NORM (normal) position provides 3 degrees per minute slaving and the FAST position slaves the gyro to the flux gate at a rate of 300 degrees per minute.

Navigation inputs to the PN-101 are from the NAV 1 receiver. The PN-101 system can be coupled to the autopilot by selecting NAV 1 on the IFCS mode selector. A repeater course deviation and glideslope indicator is located on the pilot's instrument panel for NAV 1 reference. Warning flags are incorporated for NAV 1 failure detection.

SECTION 2 - LIMITATIONS

Not Applicable.

SECTION 3 - EMERGENCY PROCEDURES

Not Applicable.

SECTION 4 - NORMAL PROCEDURES

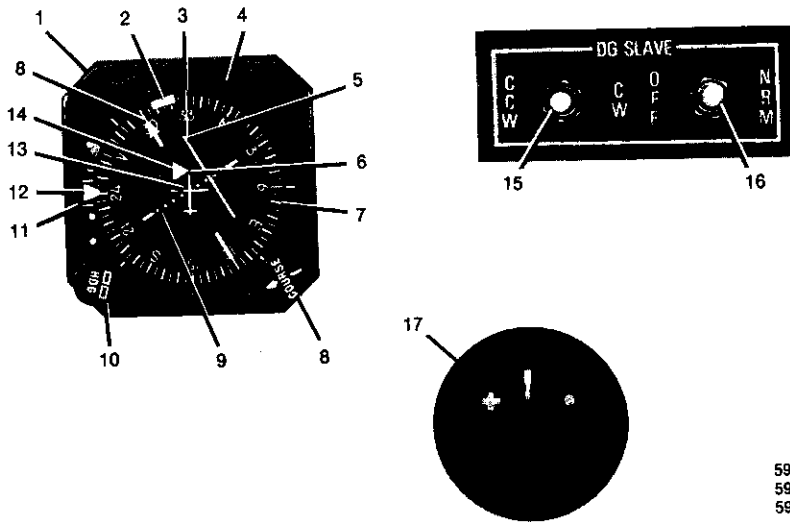
1. Preflight Check.
 - a. PN-101 and Airplane Navigation Receiver Power - ON.
 - b. HDG Flag - CHECK out of view. (after one minute).
 - c. Compass Card - CHECK that card matches airplane magnetic heading (after one minute).
 - d. Course Deviation Bar - CHECK centering and operation of TO/FROM arrows by tuning a local VOR station.
 - e. Compass Card - CHECK that card ring follows airplane heading changes during taxi.
2. Normal Operation.
 - a. NAV Receiver - SET.
 - b. HSI Heading Selector Knob - ROTATE bug to desired heading.
 - c. Course Selector Knob - ROTATE course arrow to desired VOR radial or LOC runway heading.
 - d. DG Slave Switches - AS REQUIRED.
 - e. Pilot's RMI - CROSSCHECK with HSI.
 - f. IFCS Mode Selector - AS REQUIRED.

NOTE

With the PN-101 horizontal situation indicator installed, the pilot's heading bug controls the heading when NAV 1 receiver is selected by the mode selector NAV 1/NAV 2 switch and the copilot's heading bug controls heading when NAV 2 receiver is selected.

SECTION 5 - PERFORMANCE

Not Applicable.



5914P6046
5984P6006
5984P6018

1. **HORIZONTAL SITUATION INDICATOR (HSI)** - Provides a pictorial presentation of the airplane position relative to VOR radials and localizer and glideslope beams. It also gives magnetic heading reference and provides selection of desired heading, VOR radials and LOC runway heading.
2. **HEADING MARKER** - Identifies selected heading on the compass card. Marker rotates with compass card.
3. **LUBBER LINE** - Indicates actual heading on compass card.
4. **HEADING FLAG (Not Showing)** - Flag in view indicates the heading data is not reliable.
5. **HSI COURSE DEVIATION BAR** - Displays displacement from the VOR, RNAV or localizer course.
6. **NAV FLAG (Not Showing)** - Flag in view indicates the system is inoperative or the NAV signal being received is unreliable.
7. **HSI COMPASS CARD** - Displays airplane heading. It is slaved to correct for normal precession errors. Each graduation represents five degrees.
8. **COURSE CURSOR AND COURSE SELECTOR KNOB** - Course cursor is positioned on the compass card by rotating the course selector knob; this selects a VOR radial, RNAV course or LOC runway heading. It rotates with the compass card.

Figure 1 (Sheet 1 of 2)
HORIZONTAL SITUATION INDICATOR

9. HSI COURSE DEVIATION
DOTS - Full scale course deviation bar displacement (2 dots) represents the following deviation from beam center; VOR ± 10 degrees, localizer approximately ± 2.5 degrees, RNAV en-route ± 5 nautical miles, RNAV approach ± 1.25 nautical miles.
10. HEADING BUG SELECTOR KNOB
(PN-101 Only) - Heading bug displays selected heading relative to the compass card. It is positioned by rotating the heading selector knob. The bug rotates with the compass card.
11. GLIDESLOPE FLAG (Not Showing) - Flag in view indicates the glideslope receiver signal is unreliable.
12. GLIDESLOPE POINTER AND SCALE - Displays deviation of airplane from an ILS glideslope. Flag (11) obscures scale when the signal being received is not adequate. Full scale deflection of the glideslope pointer represents ± 0.7 degrees.
13. SYMBOLIC AIRPLANE - Provides pictorial presentation of the airplane position and intercept angle relative to selected VOR radial or localizer course.
14. HSI TO-FROM INDICATOR - Indicates direction of the VOR station relative to the selected course. Displays TO when a LOC frequency is selected.
15. DIRECTIONAL GYRO SLEW SWITCH
(Located on Instrument Panel) - Allows compass card to be moved clockwise or counterclockwise manually.
16. DIRECTIONAL GYRO SLAVING SWITCH - Switch allows selection of unslaved (OFF) or slaved (NORM) mode of operation for the HSI compass card.
17. GYRO SLAVING METER - The slave meter displays synchronization of compass card with respect to the magnetic flux detector unit. The directional gyro slew switch may be used at any time to accomplish synchronization of the compass card reading with the magnetic heading as indicated by centering the slave meter indicator. A slaved condition is present when the slave meter indicator oscillates about the center line.

Figure 1 (Sheet 2 of 2)
HORIZONTAL SITUATION INDICATOR

RADIO ALTIMETER SYSTEM (AA-100)**SECTION 1 - GENERAL**

This supplement provides information which must be observed when operating the AA-100 Radio Altimeter System.

Description

The AA-100 Radio Altimeter System, refer to Figure 1, gives an absolute altitude indication from 2500 feet AGL to 40 feet AGL. The radio altimeter incorporates a warning flag to alert the pilot to a radio altimeter failure. A DH SET knob is provided to position an indexer which will trigger a visual warning when the selected altitude is reached. A self-test is included for system checkout. Pressing the TEST button causes the indicator to read 100 feet, illuminates the DH (decision height) light when decision height indexer is set above 100 feet, and brings the warning flag into view. The system receives its power from the airplane's 28-volt system.

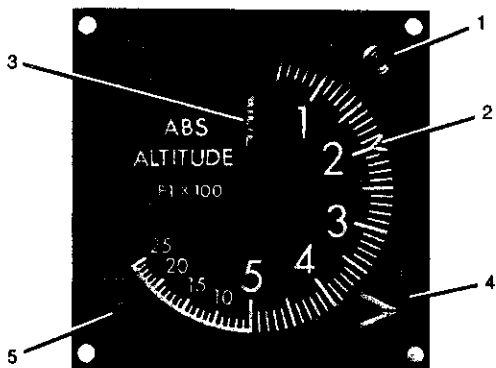
As the airplane descends below 2500 feet AGL, the pointer will indicate the airplane's absolute altitude. When the airplane reaches the preselected warning altitude, a warning light and tone burst comes on. Climbing through the selected altitude extinguishes the lights.

SECTION 2 - LIMITATIONS

Not Applicable.

SECTION 3 - EMERGENCY PROCEDURES

Not Applicable.



1014P6061

1. **DECISION HEIGHT LIGHT** - Alerts that the absolute altitude of the airplane is at or below the set altitude.
2. **DECISION HEIGHT INDEXER** - Triggers a visual warning when the selected altitude is reached.
3. **OFF FLAG** - Indicates radio altimeter power failure.
4. **DECISION HEIGHT SET KNOB** - Positions indexer around the periphery of the dial.
5. **TEST BUTTON** - Tests the altimeter for proper operation.

Figure 1
RADIO ALTIMETER INDICATOR

SECTION 4 - NORMAL PROCEDURES

1. Normal operation
 - a. Radio Altimeter Switch - ON.
 - b. Pointer - **STOWED** behind mask if on ground.
- 2500 FEET above ground level.
 - c. DH Set Knob - **AS REQUIRED**.

NOTE

During ground operation, DH function and annunciator are deactivated by the landing gear squat switch. The pointer will be stowed behind the mask. Self-test will function on the ground.

2. Ground Self-Test
 - a. DH Set Knob - 200 FEET.
 - b. Test Button - PRESS and hold. Altitude pointer will indicate 100 ± 20 feet and the DH annunciator will illuminate.
 - c. Test Button - RELEASE. After 3 seconds the pointer will stow behind the mask and the DH annunciator will extinguish.
3. In Flight Self-Test
 - a. Pointer - STOWED behind mask above 2500 feet above ground level.
 - b. DH Set Knob - 200 FEET.
 - c. Test Button - PRESS and hold. Altitude pointer will indicate 100 ± 20 feet and the DH annunciator will illuminate.
 - d. Test Button - RELEASE. After 3 seconds the pointer will stow behind the mask and the DH annunciator will extinguish.

NOTE

Altitude pointer will stow behind mask below 2500 feet AGL if the ground return signal is lost or when the airplane is in a bank in excess of 45 degrees.

SECTION 5 - PERFORMANCE

Not Applicable.

—

—

RADIO MAGNETIC INDICATOR (7100 RMI)**SECTION 1 - GENERAL**

This supplement provides information which must be observed when operating the 7100 Radio Magnetic Indicator.

Description

The Aeronetics 7100 RMI Radio Magnetic Indicator is used in conjunction with other airborne navigation equipment to aid the pilot in navigating the airplane. The RMI eliminates the need for many of the numerical and graphical computations necessary for determining airplane position.

The RMI, refer to Figure 1, is a panel-mounted navigation instrument that combines the display of VOR and ADF bearing information with the airplane heading on a single instrument. The VOR and ADF bearings are displayed by individual rotating pointers against the background of a rotating azimuth card. The azimuth card is driven by the slaved magnetic compass system in the airplane and continuously indicates airplane heading.

The RMI display consists of a rotating azimuth card, a fixed heading index, a double-bar pointer and a single-bar pointer, refer to Figure 1. The azimuth card is slaved to the magnetic heading signal and rotates as the airplane turns so that the magnetic heading of the airplane is continuously displayed at the heading index.

Each pointer serves to indicate ADF or VOR bearings according to the position of its selector switch. The selector switches, one at each lower corner of the RMI, have ADF and VOR positions. The knobs are identified with a single or double line to relate to the single and double-bar pointers.

SECTION 2 - LIMITATIONS

Not Applicable.

SECTION 3 - EMERGENCY PROCEDURES

Not Applicable.

SECTION 4 - NORMAL PROCEDURES

1. Normal Operation

NOTE

Operation of the RMI is dependent upon input information from the compass system (slaved directional gyro), the associated VHF navigation and ADF receivers. Refer to the appropriate supplements in this section for operation of this equipment.

- a. Compass Cards
(On RMI and Directional Gyro or HSI) - HEADING READINGS indicated on RMI and directional gyro or HSI will be the same.
- b. ADF Receiver - SELECT STATION on receiver.
- c. ADF/VOR SELECTOR SWITCH-SINGLE BAR - ADF. The single-bar pointer will indicate the bearing of the station.

NOTE

●Repeat steps b and c using the double-bar switch and pointer if only one ADF is installed.

●If a second ADF receiver is installed, repeat steps b and c using ADF 2 and the double-bar switch and pointer.

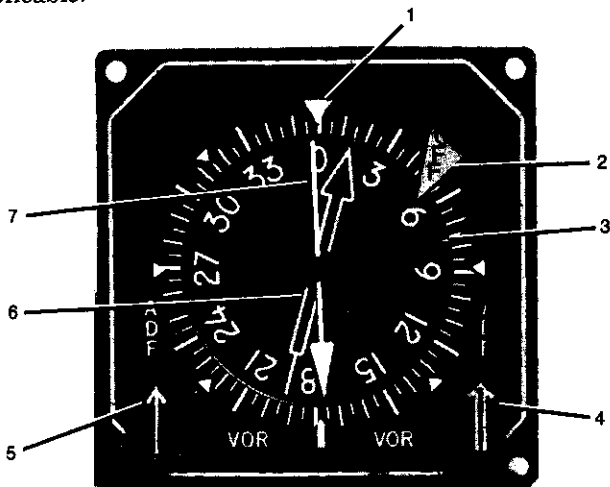
- d. NAV 1 Receiver - SELECT VOR STATION on number one NAV receiver.
- e. ADF/VOR SELECTOR SWITCH-SINGLE BAR - VOR. The single-bar pointer will indicate the bearing of the station.
- f. NAV 2 Receiver - SELECT VOR STATION on number two NAV receiver.
- g. ADF/VOR SELECTOR SWITCH-DOUBLE BAR - VOR. The double-bar pointer will indicate the bearing of the station.

NOTE

Absence of a valid VOR signal, switching to the ILS mode or switching the ADF receiver to ANT will cause the pointers to stow in the 3 o'clock positions.

SECTION 5 - PERFORMANCE

Not Applicable.



5914P6032

1. **HEADING INDEX** - Indicates the airplane magnetic heading on the azimuth card.
2. **OFF WARNING FLAG** - Indicates loss of instrument power or servo error.
3. **ROTATING AZIMUTH (COMPASS) CARD** - Rotates as the airplane turns so that the airplane magnetic heading is continuously displayed at the heading index.
4. **ADF/VOR SELECTOR SWITCH-DOUBLE BAR** - Selects ADF or VOR operation of double-bar pointer.
5. **ADF/VOR SELECTOR SWITCH-SINGLE BAR** - Selects ADF or VOR operation of single-bar pointer.
6. **DOUBLE-BAR POINTER** - Indicates the magnetic bearing of the selected ADF-1 (Single ADF installation), ADF-2 (dual ADF installation), or VOR 2 station.
7. **SINGLE-BAR POINTER** - Indicates the magnetic bearing of the selected ADF 1 or VOR 1 Station.

Figure 1
RADIO MAGNETIC INDICATOR

1

2

1000 RADIO MAGNETIC INDICATOR (IN-1004A/B)**SECTION 1 - GENERAL**

This supplement provides information which must be observed when operating the 1000 Radio Magnetic Indicator.

Description

The 1000 Radio Magnetic Indicator (RMI) (Type IN-1004A/B) is a panel-mounted unit that includes both a radio magnetic indicator assembly and a VHF radio magnetic indicator converter circuit. The RMI is used in conjunction with other airborne navigation sets to aid the pilot in navigating and maintaining direction of the airplane. Use of the RMI eliminates the need for many of the numerical and graphical computations normally associated with air navigation.

The RMI converter circuit interprets the navigation signal from either of two VHF navigation receivers, as selected, and combines it with magnetic heading information from a stabilized heading source to provide continuous airplane-to-omnirange bearing.

The RMI display consists of a rotating azimuth card, a fixed heading index, a double-bar pointer and a single-bar pointer, refer to Figure 1. The azimuth card is slaved to the magnetic heading signal and rotates as the airplane turns so that the magnetic heading of the airplane is continuously displayed at the heading index. A two-position switch (not on IN-1004B) on the lower left corner of the RMI selects input signals from one of two ADF receivers to be applied to the double-bar pointer of the display. A three-position switch on the lower right corner selects operation of the single-bar pointer by information from either of two VHF navigation receivers or from the RNAV computer. When the switch is set to either NAV 1 or NAV 2, the navigation signals from the selected receiver are applied to the RMI converter circuits for interpretation and are then displayed by the single-bar pointer. When the switch is set to RN, signals from the RNAV computer are coupled to the single-bar pointer for display, and a green annunciator light (RN) on the RMI illuminates. If the switch is set to RN and RNAV operation has not been selected on the DME control, the lamp will flash. The two RMI pointers display the magnetic bearing to the selected ADF and VOR stations or RNAV waypoint. Either of the pointers can be temporarily displaced by external test switches to verify the displayed information.

SECTION 2 - LIMITATIONS

Not Applicable.

SECTION 3 - EMERGENCY PROCEDURES

Not Applicable.

SECTION 4 - NORMAL PROCEDURES

NOTE

Operation of the RMI is dependent upon input information from the stabilized heading source (slaved directional gyro), the associated VHF navigation and ADF sets, and the RNAV system. Refer to the appropriate supplements for operation of this equipment.

1. Normal Operation

a. Directional

Gyro - TURN ON and allow gyro to stabilize. The azimuth card on the RMI should rotate to bring the airplane magnetic heading to the heading index. Check that the heading on the gyro and RMI agree.

b. ADF Function

Switch - SET to either ADF 1 or ADF 2 and select station on the associated ADF set. The double-bar pointer will indicate the station bearing.

NOTE

If only one ADF system is installed, switching to ADF 2 will cause the double-bar pointer to park at either the 3 o'clock or 9 o'clock position.

c. Function

Switch - SET to NAV 1 or NAV 2 and select OMNI station on the associated VHF navigation set. The single-bar pointer will indicate the station bearing.

d. Waypoint - SELECT on area navigation system.

e. Function

Switch - RN. RN annunciator light will illuminate and the single-bar pointer will indicate the waypoint bearing.

2. RMI Test

a. ADF Test

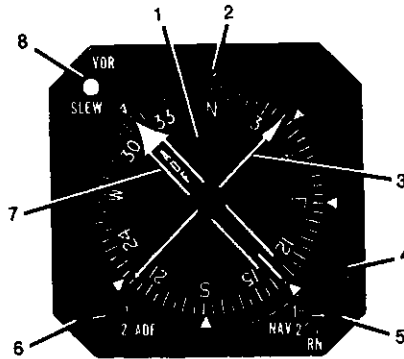
Switch - PRESS. Double-bar pointer will slew away from the station bearing. Release test switch and the double-bar pointer will return to the station bearing.

b. VOR SLEW

Switch - PRESS. Single-bar pointer will slew away from the station or waypoint bearing. Release test switch and the single-bar pointer will return to the station or waypoint bearing.

SECTION 5 - PERFORMANCE

Not Applicable.



1014P6084

1. ROTATING AZIMUTH

CARD - Slaved to remote stabilized heading source; rotates as the airplane turns so that the airplane magnetic heading is continuously displayed at the heading index.

2. HEADING INDEX - Indicates the airplane magnetic heading on the azimuth card.

3. SINGLE-BAR POINTER - Indicates the magnetic bearing to the VOR station or RNAV waypoint, as selected by the function switch.

4. RN ANNUNCIATOR - Green lamp illuminates when the function switch is set to RN to indicate that the single-bar pointer is displaying a waypoint bearing. If the function switch is set to RN but the DME switch is not set to RNAV, the lamp will flash to indicate that the displayed bearing is not reliable.

**Figure 1 (Sheet 1 of 2)
RADIO MAGNETIC INDICATOR**

5. NAV 1/NAV 2/RN FUNCTION
SWITCH - Selects signals from NAV 1 or NAV 2 VHF navigation receiver or RNAV computer for display by the single-bar pointer.
6. ADF FUNCTION SWITCH
(Not on IN-1004B) - Selects signals from ADF 1 or ADF 2 for display by the double-bar pointer. Not used with single ADF and optional RNAV.
7. DOUBLE-BAR POINTER - Indicates bearing of selected ADF station.
8. VOR SLEW
SWITCH - Momentary contact switch used to verify the displayed VOR or RNAV station bearing. When the switch is pressed, the single-bar pointer slews away from the station bearing; when the switch is released, if equipment operation is normal, the pointer will return to the station bearing.

**Figure 1 (Sheet 2 of 2)
RADIO MAGNETIC INDICATOR**

TRANSCEIVER (HF-220)**SECTION 1 - GENERAL**

This supplement provides information which must be observed when operating the HF-220 transceiver.

Description

The HF-220 system provides simplex operation on any one of 210,000 pilot-selected discrete frequencies within the 2.0000 to 22.9999 MHz frequencies range (frequency spacing is 100 Hz). In addition, the HF-220 provides 16 separate channels that can be programmed for either simplex or half duplex operation throughout the range. The primary operating mode is single sideband (USB, TEL A3A, or TEL A3J modes); however, an AM equivalent signal (upper sideband with the carrier inserted) can be transmitted when operating with stations having only AM capability.

The HF-220 system consists of a TCR-220 Transceiver (100-watts), a PWR-200 Power Amplifier, a CTL-220 Control and the accessory AAC-200 Automatic Antenna Coupler.

SECTION 2 - LIMITATIONS

Not Applicable.

SECTION 3 - EMERGENCY PROCEDURES

Not Applicable.

SECTION 4 - NORMAL PROCEDURES

1. To Receive
 - a. HF COM Switch - ON.
 - b. HF COM Audio Switch - **SPEAKER** or **PHONE** (on Audio Control Panel).
 - c. **MODE CONTROL**
(Outer Knob) - **TURN** clockwise and select desired mode of operation (VSB, AM, TEL A3A or TEL A3J). Allow 15 minute warmup (time required for frequency standard to stabilize).
 - d. **V (Volume Control)** - **TURN** control clockwise to vary the audio gain (inner knob).

NOTE

If microphone for HF-220 system is wired through audio panel, ensure HF COMM is selected before proceeding.

- e. CHAN/FREQ SWITCH - SELECT desired method of frequency selection (FREQ/CHAN) with two position switch.
- f. CHANNEL/FREQUENCY CONTROLS - SELECT frequency or channel using the dual rotary frequency/channel select switches. If selecting a channel, use the pullout channel/frequency card to correlate channel number and frequency.
- g. Squelch Control - ADJUST counterclockwise for normal noise output; then, slowly adjust clockwise until the receiver is silent.
- h. Clarifier Control - ADJUST when upper single sideband RF signal is being received for maximum clarity. Adjust V (volume) control for comfortable listening level.

To turn the HF system antenna coupler to the frequency (channel) selected, rotate the V (volume) Knob out of the off detent and allow 15 minutes warmup. Key the transmitter by momentarily pressing microphone button. The antenna coupler will tune automatically and a steady tone will be heard during the tuning cycle. Normal turning cycle requires 5 to 10 seconds. Within one second after completion of antenna coupler tuning cycle, the tone will cease, indicating that the system is ready for use. If the antenna coupler does not tune after 30 seconds, the tone will begin to "beep" indicating that a fault has occurred, in which case, rechannel and initiate a new cycle.

When tuning is complete, slowly rotate squelch control to desired squelch threshold. During reception (except for AM mode) adjust clarifier control for maximum signal clarity or most natural sounding voice.



DO NOT ROTATE SQUELCH CONTROL TOO FAST. SQUELCH CIRCUIT HAS A RELATIVELY LONG TIME CONSTANT AND ROTATING KNOB TOO FAR MAY RESULT IN MISSED CALLS ON SOME OF THE WEAKER SIGNALS.

NOTE

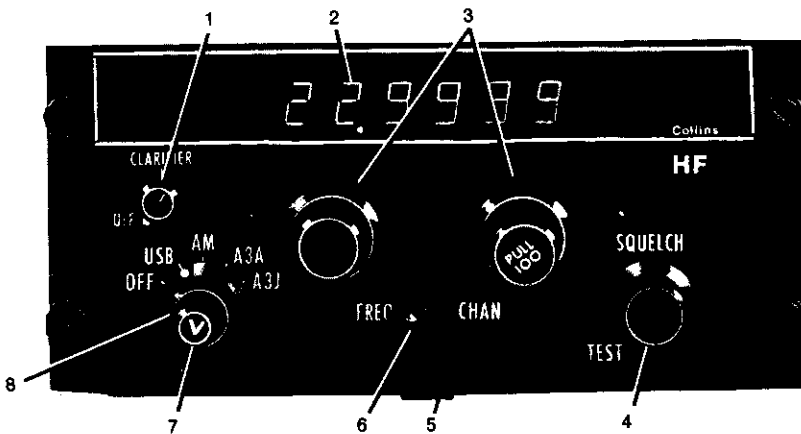
Under certain atmospheric noise conditions, receiver noise may disappear immediately after SQUELCH control is rotated out of detent (TEST) position. This is normal, and knob should be left in this position unless interference or noise requires a higher squelch threshold setting later.

2. To Transmit.

- a. Microphone Button - Depress and speak in a normal voice. The presence of sidetone during transmission is an indication of proper operation.

SECTION 5 - PERFORMANCE

Not Applicable.



6085P6011

1. CLARIFIER CONTROL

- The control permits the pitch of the received signal to be varied ± 100 Hz when operating in USB mode or either TEL modes. The control is adjusted for the best clarity or the most natural sound of the signal being received. The clarifier function does not affect AM reception, and is disabled during transmit or when the control is positioned to OFF.

**Figure 1 (Sheet 1 of 2)
HF-220 TRANSCEIVER CONTROLS**

2. FREQUENCY/CHANNEL

DISPLAY - The six-digit frequency/channel display indicates the selected operating frequency or channel that is selected with the dual rotary frequency/channel select switches.

The display brightness is controlled remotely by a dimming potentiometer or a variable dimming voltage independent of the integral panel lighting dimming control.

3. CHANNEL/FREQUENCY

CONTROLS - Two double concentric knobs provide for the selection of 210,000 frequencies with the **FREQ/CHAN** switch in **FREQ**. In **CHAN** position, the knobs select any of the 16 programmed channels (the display will indicate 01 through 16).

4. SQUELCH

CONTROL - The rotary squelch knob provides control of the squelch threshold. Setting the control too far clockwise can result in blocking out weak signals. When the **SQUELCH** control is in the **TEST** position, the squelch circuit is, in effect, removed from the receiver audio circuits. In this position maximum background noise (depending on **V** control setting) will be heard. Rotating the control clockwise sets the squelch threshold required for reception.

5. CHANNEL/FREQUENCY

CARD - A pullout card at the lower edge of the control panel provides an index of frequencies programmed for each of the 16 channels.

6. CHAN/FREQ

SWITCH - Two-position switch selects the frequency tuning method. In **FREQ**, the frequency is displayed to up to six digits which are controlled by all of the frequency/channel selector switches. In **CHAN**, the channel is displayed in two digits which are controlled by any one of the frequency/channel selector switches.

7. VOLUME CONTROL - Varies level of audio gain.

8. MODE CONTROL - Selects system mode of operation.

OFF - Controls power to the system.

USB - Selects upper sideband operation for long-range voice communications.

AM - Selects compatible AM operation and full AM reception.

TEL A3A/A3J - Used for communications with public correspondence coastal stations in the maritime services, and other radio-telephone services.

Figure 1 (Sheet 2 of 2)
HF-220 TRANSCEIVER CONTROLS

400 TRANSPONDER (459A)**SECTION 1 - GENERAL**

This supplement provides information which must be observed when operating the transponder.

Description

The 400 transponder (Type 459A) is the airborne component of an Air Traffic Control Radar Beacon System (ATCRBS). The transponder enables the ATC ground controller to "see" and identify the airplane, while in flight, at distances beyond the primary radar range.

The 400 transponder consists of a panel-mounted unit and an externally mounted antenna. The transponder receives interrogating pulse signals on 1030 MHz and transmits coded pulse-train reply signals on 1090 MHz. It is capable of replying to Mode A (airplane position identification) and Mode C (altitude information) interrogations on a selective reply basis on any of 4096 information code selections. When an optional panel-mounted EA-401A altitude encoder (not part of the 400 transponder system) is included in the avionics configuration, the transponder can provide altitude reporting in 100-foot increments between -1000 and +35,000 feet.

All 400 transponder operating controls, refer to Figure 1, are located on the front panel of the unit. The optional altitude encoder's barometric pressure set knob is located on the face of the encoding altimeter.

SECTION 2 - LIMITATIONS

Not Applicable.

SECTION 3 - EMERGENCY PROCEDURES

1. To Transmit An Emergency Signal
 - a. Function Switch - ON.
 - b. Reply-Code Selector Switches - Select 7700 operating code.
 - c. ID Switch - PRESS to effect immediate identification of airplane on ground controller's displays.
2. To Transmit A Signal Representing Loss of All Communications.
 - a. Function Switch - ON.
 - b. Reply-Code Selector Switches - SELECT 7700 operating code for 1 minute, then select 7600 operating code for 15 minutes and then repeat this procedure for the remainder of the flight.

- c. ID Switch - PRESS to effect immediate identification of airplane on the ground controller's display.

SECTION 4 - NORMAL PROCEDURES

1. Before Takeoff.
 - a. Function Switch - SBY. Allow 30 Seconds Warmup.
2. To Transmit Mode A (Airplane Position Identification) Codes In Flight.
 - a. Reply-Code Selector Switches - SELECT assigned code.
 - b. Function Switch - ON.
 - c. DIM Control - ADJUST light brilliance of replay lamp.

NOTE

During normal operation, with the function switch in the ON position, the REPLY lamp will flash which indicates transponder is replying to interrogations.

- d. ID Button - PRESS momentarily when instructed by ground controller to "squawk IDENT". REPLY lamp will glow steadily, indicating IDENT operation.
3. To Transmit Mode C (Altitude Information) Codes In Flight.
 - a. Barometric Pressure Set Knob - DIAL assigned barometric pressure.
 - b. Reply-Code Selector Switches - SELECT assigned code.
 - c. Function Switch - ALT.

NOTE

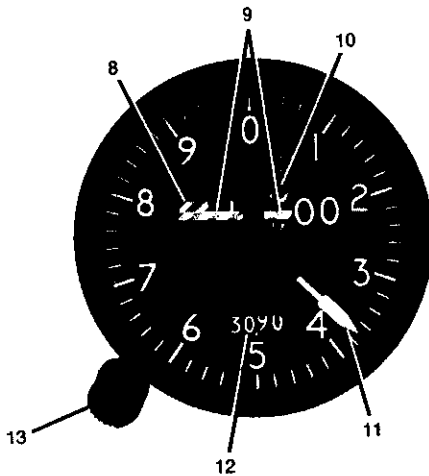
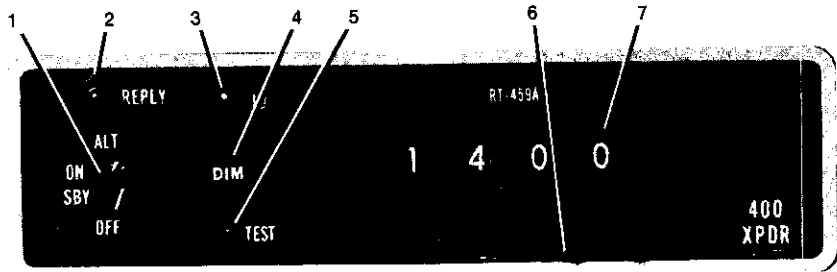
● *When directed by ground controller to "stop altitude squawk", turn function switch to ON for Mode A operation only.*

● *Pressure altitude is transmitted, and conversion to indicated altitude is done in ATC computers. Altitude squawk will agree with indicated altitude when altimeter setting in use by the ground controller is set in the altitude encoder.*

- d. DIM Control - ADJUST light brilliance of replay lamp.
4. Self-Test
 - a. Function Switch - SBY and wait 30 seconds for equipment to warm up.
 - b. Function Switch - ON.
 - c. TST Button - PRESS. Reply lamp should light brightly regardless of DIM control setting.

SECTION 5 - PERFORMANCE

Not Applicable.



1014P6027
1014P6042

1. **FUNCTION SWITCH** - Controls application of power and selects transponder operating mode, as follows:
 - OFF** - Removes power from transponder (turns set off).
 - SBY** - Applies power for equipment warm-up.
 - ON** - Applies operating power and enables transponder Mode A reply pulses.
 - ALT** - Applies operating power and enables transponder to transmit either Mode A replay pulses or Mode C altitude information pulses selected automatically by the interrogating signal.

Figure 1 (Sheet 1 of 2)
400 TRANSPONDER CONTROL PANEL
AND ALTIMETER INDICATOR

2. **REPLY LAMP** - Provides visual indication of transponder replies. During normal operation, lamp flashes when reply pulses are transmitted; when special pulse identifier is selected, lamp glows steadily for duration of IDENT pulse transmission. (Reply lamp will also glow steadily during initial warm-up period).
3. **IDENT SWITCH** - When pressed, selects special pulse identifier to be transmitted with transponder reply to effect immediate identification of airplane on ground controller's display. (Reply lamp will glow steadily during duration of IDENT pulse transmission.)
4. **DIMMER CONTROL** - Allows pilot to control brilliance of reply lamp.
5. **SELF-TEST SWITCH** - When depressed, causes transponder to generate a self-interrogating signal to provide a check of transponder operation. (Reply lamp will illuminate to verify self-test operation.)
6. **REPLY-CODE SELECTOR SWITCH (4)** - Select assigned Mode A (or Mode C) reply code.
7. **REPLY-CODE INDICATOR (4)** - Display selected Mode A (or Mode C) reply code.
8. **1000-FOOT DRUM-TYPE INDICATOR** - Provides digital altitude readout in 1000-foot increments between -1000 feet and +35,000 feet.
9. **OFF INDICATOR WARNING FLAG** - Flag appears when power is removed from the system.
10. **100-FOOT DRUM-TYPE INDICATOR** - Provides digital altitude readout in 100-foot increments between 0 feet and 999 feet.
11. **20-FOOT INDICATOR NEEDLE** - Indicates altitude in 20-foot increments between 0 feet and 1000 feet.
12. **BAROMETRIC PRESSURE SET INDICATOR - DRUM-TYPE** - Indicates selected barometric pressure in the range of 27.9 to 31.0 inches of mercury.
13. **BAROMETRIC PRESSURE SET KNOB** - Dials in desired barometric pressure setting in the range of 27.9 to 31.0 inches of mercury.

Figure 1 (Sheet 2 of 2)
400 TRANSPONDER CONTROL PANEL
AND ALTIMETER INDICATOR

WEATHER RADAR (RDR-160)**SECTION 1 - GENERAL**

This supplement provides information which must be observed when operating the RDR-160 Weather Radar.

Description

The Bendix RDR-160 Weather Radar is used to detect significant enroute weather formations within a range of 160 nautical miles to preclude undesirable penetration of heavy weather and its usually associated turbulence. The indicator is mounted in the center of the instrument panel. The RDR-160 system consists of an indicator and a combination transceiver/parabolic-dish antenna located in the nose radome. Power for the system is provided by the airplane's 28-volt system. All controls for the system, refer to Figure 1, are located on the lower section of the front panel. Internally generated range marks appear as evenly spaced concentric arcs on the display to assist in determining range to the weather target. Reference marks on each side of the zero heading assist in determining azimuth bearing weather targets. A secondary objective of the weather radar system is gathering and presentation of terrain data.

SECTION 2 - LIMITATIONS

1. Do not operate radar within 15 feet of ground personnel or containers holding flammable or explosive material.
2. Do not operate radar during fueling operations.
3. When preflighting the radar system, ensure that the airplane is facing away from buildings or large metal structures that are likely to reflect significant amounts of radar energy back into the system.
4. Do not operate radar above 20,000 feet flight altitude.

SECTION 3 - EMERGENCY PROCEDURES

Not Applicable.

SECTION 4 - NORMAL PROCEDURES

1. Preflight Test

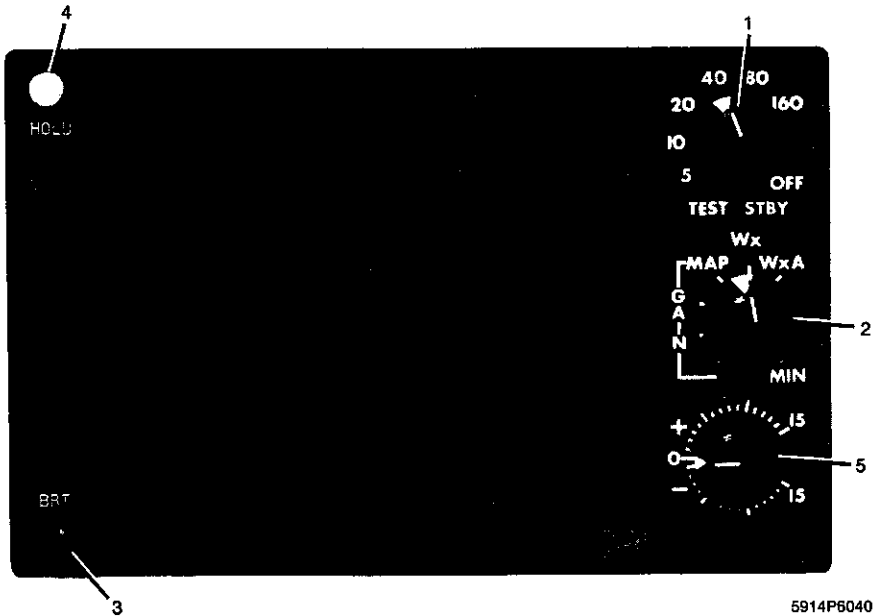
- a. Function Switch - TEST. Allow 2 minutes warm-up.
- b. Wx Gain Switch - Wx.
- c. Hold/Scan Switch - SCAN.
- d. Tilt Switch - +4 degrees.
- e. Brt Switch - AS REQUIRED.
- f. Self-Test - CHECK. Four equally spaced range marks should appear, no displayed "noise" and two distinct brightness levels should appear. Strobe line should smoothly sweep full 90 degrees.
 - (1) Hold/Scan Switch - HOLD. Strobe line should disappear and test pattern should "freeze" on indicator.
 - (2) Wx Gain Switch - Wx A. Test pattern should pulse on indicator.
 - (3) Hold/Scan Switch - SCAN.
 - (4) Function Switch - 10 or 20. Transmitter on.
 - (5) Tilt Switch - VARY between 0 degrees and 15 degrees. Close in ground clutter appears at lower tilt settings and any local moisture laden weather appears at higher tilt settings.

2. Normal Operation

- a. Function Switch - STBY. Allow 2 minutes warm-up.
- b. Wx Gain Switch - GAIN. Adjust manual gain as required.
- Wx. For contour mode of operation.
- c. Function Switch - AS REQUIRED.
- d. Brt Switch - AS REQUIRED.
- e. Wx A Switch - AS REQUIRED.
- f. Hold/Scan Switch - AS REQUIRED.
- g. Tilt Control - AS REQUIRED.

SECTION 5 - PERFORMANCE

Not Applicable.



5914P6040

1. **FUNCTION SWITCH** - Controls application of power and selects weather radar operating ranges as follows:
 - OFF** - Removes power from the weather radar (turns equipment off).
 - STBY** - Applies power to system for warm-up (warm-up time is approximately 2 minutes) and when system is not in use.
 - TEST** - Applies drive to antenna and activates test circuit and indicator display to determine operability of system.
 - 5, 10, 20, 40, 80, 160 - Energizes system and selects respective nautical mile maximum range.

NOTE

Each time the function switch position is changed, the indicator presentation is automatically erased so that information on the newly selected function may be presented without confusion.

**Figure 1 (Sheet 1 of 2)
WEATHER RADAR CONTROLS**

2. **Wx-GAIN/Wx A SWITCH** - Selects weather radar mode of operation.
 - Wx** - Places indicator in automatic contour mode. Contoured storm cells will be outlined by lighter shades automatically.
 - GAIN** - Places indicator in MAP mode (disables contour feature) and activates manual gain control. All targets will be presented on the indicator in up to 3 different shades, dependent on the radar echo strength and the particular click-gain setting used.
 - Wx A** - When the mode selector is in the Wx A position, the display on the indicator will cycle to verify if a dark hole is a contour or a storm cell. Its presentation will alternate from darkest shade to brightest shade approximately 4 times per scan. If a dark hole remains the same intensity while in the Wx A mode, then this area of the display does not represent a contour or storm cell.
3. **BRT CONTROL** - Controls the brightness of the indicator display.
4. **HOLD/SCAN SELECTOR** - Provides antenna hold/scan selection. The selector is a push-push button. Pushing the button in puts the image in the hold mode; pushing the button in again puts the image in the scan mode.
 - HOLD** - Weather or ground mapping image last presented is retained (frozen) on the indicator display in order to evaluate the significance of storm cell movement. Switching back to scan from hold mode reveals direction and distance of target movement during hold period. During HOLD mode, the antenna continues to scan and the display will continue to be presented as long as power is supplied to the system and the range is not changed.
 - SCAN** - The SCAN position places the antenna in a 90 degrees scan mode ± 45 degrees to each side of the airplane's longitudinal axis.
5. **TILT CONTROL** - Electrically adjusts the antenna parabola to move the radar beam to 15 degrees up or down from horizontal ("0" position).

Figure 1 (Sheet 2 of 2)
WEATHER RADAR CONTROLS

WEATHER RADAR COLOR DISPLAY (RDR-160XD)**SECTION 1 - GENERAL**

This supplement provides information which must be observed when operating the RDR-160XD Color Display radar.

Description

The Bendix RDR-160XD Color Display radar is used to detect significant enroute weather formations within a range of 160 nautical miles to preclude undesirable penetration of heavy weather and its usually associated turbulence. The indicator is mounted in the center of the instrument panel. The RDR-160XD system consists of an indicator and a combination transceiver/parabolic-dish antenna located in the nose radome. Power is provided by the airplane's 28-volt system. All controls for the system are located on the front panel of the indicator, refer to Figure 1. The weather radar portion of the display consists of light, medium and heavy rainfall areas shown in green, yellow and red respectively. Internally generated range marks appear as evenly spaced concentric arcs on the display to assist in determining range to the weather target or terrain feature under observation. Azimuth reference marks are also provided as an aid in determining the relative bearing to the target. System function in use as well as the range and range marks in use are digitally displayed on the screen in the upper corners. The radar's hold mode permits the display to be frozen on the screen for extended periods in order to evaluate the significance of storm movement. Switching back to scan instantly reveals the direction and distance the target has moved during the hold period. In the weather alert mode, the display flashes a warning to the pilot of any heavy rainfall areas exceeding 0.47 inch (12 millimeters) per hour within the display range by alternately switching the contour/normal display modes approximately 4 times per antenna scan. The pilot then sees the red portion of any storm cell as a flashing on/off display. Each time the operational mode of the system is changed, a momentary digital display is presented on the indicator which shows available and active mode data such as range/range marks and rainfall intensity color key.

In addition to its primary function of weather detection, the radar also enables mapping of prominent terrain features such as lakes, bays, rivers, inlets, shorelines, channel markers and offshore oil rigs.

SECTION 2 - LIMITATIONS

1. Do not operate the radar system within 15 feet of ground personnel or containers holding flammable or explosive material.
2. Do not operate the radar system during fueling operations.
3. When preflighting the radar system, ensure that the airplane is facing away from buildings or large metal structures that are likely to reflect significant amounts of radar energy back into the system.
4. Do not operate radar above 20,000 feet flight altitude.

SECTION 3 - EMERGENCY PROCEDURES

Not Applicable.

SECTION 4 - NORMAL PROCEDURES

1. Preflight Test
 - a. Function Switch - TEST. Allow 2-minute warm-up.
 - b. TILT Control - 0 degrees.
 - c. BRT Control - Mid-range position.
 - d. Self-Test - CHECK:
 - (1) Test pattern should display five colored bands; starting with the closest band at the bottom of the screen, the bands will be green, yellow, red, yellow and green. The red band represents the most intense level. All range marks will be visible and displayed in blue letters.

NOTE

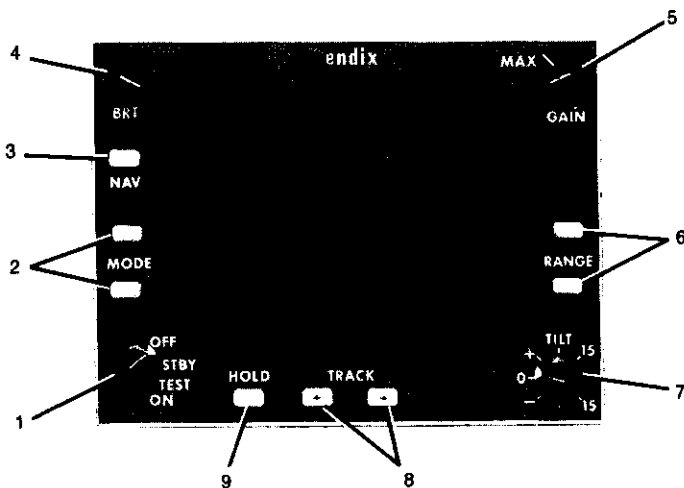
Width of test pattern bands and position of bands relative to the range marks is not critical.

- (2) MODE Buttons - Sequence to Wx A mode. The red test band should alternate from red to black approximately once per second. Return the mode to Wx.
- (3) HOLD Button - PRESS. The word HOLD should flash in the upper LH corner.
- e. Function Switch - STBY. Ensure area ahead of airplane is clear as stated in Section 2 - Limitations of this supplement.
- f. Function Switch - ON. The indicator will automatically switch to the Wx mode.
- g. HOLD Button - Check OFF.
- h. RANGE Buttons - 40-mile range.

- i. TILT Control - Move UP in small increments until a clear picture of any local weather appears. Close-in ground targets may also appear in the display.
 - j. RANGE Buttons - Select remaining ranges and repeat TILT control check.
 - k. FUNCTION Switch - STBY prior to taxi.
 - l. Checklist Display - If optional checklist display system is installed, refer to CC-2024A or CC-2024B Checklist Supplement for preflight test procedures.
2. Normal Operations
- a. Function Switch - STBY. Allow 2 minutes warm-up.
 - b. MODE Buttons - AS REQUIRED.
 - (1) Wx - For normal weather display.
 - (2) Wx A - For weather alert (flashing red area).
 - (3) MAP - For terrain mapping.
 - c. Function Switch - AS REQUIRED.
 - d. BRT Control - AS REQUIRED.
 - e. GAIN Control - AS REQUIRED (For Terrain Mapping Only).
 - f. RANGE Buttons - AS REQUIRED.
 - g. TRACK Button - AS REQUIRED.
 - h. TILT Control - AS REQUIRED.

SECTION 5 - PERFORMANCE

Not Applicable.



5484P6010L

1. **FUNCTION SWITCH** - Turns unit on and off and selects the following functions:
 - OFF** - Removes power from the weather radar (turns equipment off).
 - STBY** - (Standby) Applies power to system for warm-up (warm-up time approximately 2 minutes) and maintains unit in a ready status to allow immediate use when desired.
 - TEST** - Applies drive to antenna, activates test circuitry and provides a display test pattern for checking proper operation of the system. No radar energy is transmitted in the test mode. Checklist function remains operable when unit is in the test mode.
 - ON** - Normal operating position. Radar energy is transmitted and display picture is received.
2. **MODE BUTTONS** - Select weather, weather alert or terrain mapping modes. The symbol for the mode selected appears in the lower LH corner of the display screen.
 - Wx** - (Weather) Displays normal weather picture in three colors of weather intensity (green-light, yellow-medium, red-heavy).
 - Wx A** - (Weather Alert) Displays the same picture as Wx mode except the high intensity red area flashes on and off as a warning to the pilot.

**Figure 1 (Sheet 1 of 3)
WEATHER RADAR CONTROLS**

MAP - (Terrain Mapping) Places system in terrain mapping mode. In this mode, prominent ground features are presented in three colors of intensity, depending on the strength of target return (green-light return, yellow-medium return, red-heavy return).

Pressing either mode button momentarily displays an "information list" of pertinent operational data including available modes range/range marks and applicable color/signal level reference. Pressing either button again advances the display to the next adjacent mode on the information list, above or below the displayed mode, depending upon the button depressed.

When either the top or bottom mode is reached, the opposite button must be depressed in order to further change the operational mode. The active mode is displayed in blue while the remaining modes are yellow.

3. NAV BUTTON - Non-functional. Pressing the NAV button displays the words NO NAV in the lower left corner of the screen below the active mode.
4. BRT CONTROL - Adjusts brightness of the display to accommodate variation in cockpit lighting.
5. GAIN CONTROL - Permits adjusting the radar receiver gain in the terrain MAP mode only.

NOTE

In the TEST function as well as in all weather modes, the receiver gain is preset; thus, no adjustment is required.

6. RANGE BUTTONS - The button with the upward-pointing arrow clears the screen and advances the display to the next higher range, each time the button is depressed, until the maximum range is reached. Subsequently, the RANGE button with the downward-pointing arrow must be depressed in order to select a lower range.

A selected range of 20, 40, 80 or 160 nautical miles is displayed in blue in the upper right corner of the screen adjacent to the top range mark. The distance from the apex of the display to each of the other range marks is also annunciated at the right end of each mark.

**Figure 1 (Sheet 2 of 3)
WEATHER RADAR CONTROLS**

7. TILT CONTROL - Permits positioning the antenna beam up or down within the maximum limits of +15 degrees to -15 degrees from the horizontal of 0 degrees.
8. TRACK BUTTONS - When pressed, a yellow track line extending from the apex of the display through the top range mark appears and moves either right or left to a maximum of 30 degrees from center, depending upon the button depressed. The differential bearing is indicated in yellow numerals in the upper left corner of the screen. The track line and relative bearing display disappears approximately 15 seconds after the TRACK button is released.
9. HOLD BUTTON - Inhibits normal display update of weather, terrain or mapping data. The last image presented before pressing the HOLD button is retained until the button is pressed again. In this mode, the word HOLD flashes on and off in the upper left corner of the screen as a reminder that no new data is being presented. However, the antenna continues to scan in order that an accurate and instant update can occur the moment HOLD is deactivated. The static display during HOLD will continue until the HOLD button is pressed a second time or until power is removed from the system. A change in range selection during HOLD results in a blank screen.

Figure 1 (Sheet 3 of 3)
WEATHER RADAR CONTROLS

SUPPLEMENT

KING AREA NAVIGATION SYSTEM

(Type KNS-81)

SECTION 1

GENERAL

The King KNS-81 Area Navigation System consists of an integral 200-channel VOR/Localizer Receiver, an integral 40-channel Glide Slope Receiver, a Digital RNAV Computer, a KI-206 Course Deviation Indicator with remote back-course (BC) light and the KN-63 Digital DME. The Digital RNAV Computer combines the inputs from the integral NAV Receiver and the remote Digital DME to compute navigation data for the selected waypoints. The KNS-81 RNAV course information is displayed on the NAV 1 or NAV 2 CDI (depending on system selected) and KDI-572 DME Indicator. The KNS-81 also provides the digital course information necessary to drive the optional KI-229 RMI Indicator (described in Supplement 33 in Section 9 of this handbook) for pointing to the VORTAC or the RNAV waypoint.

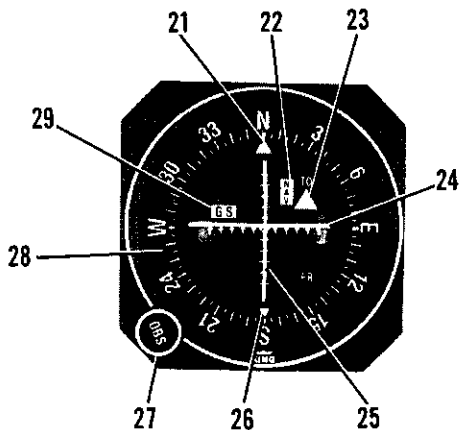
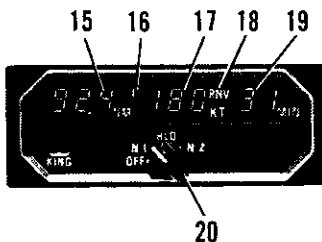
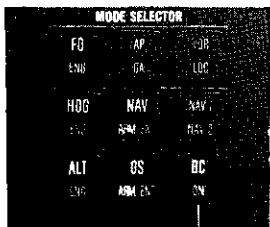
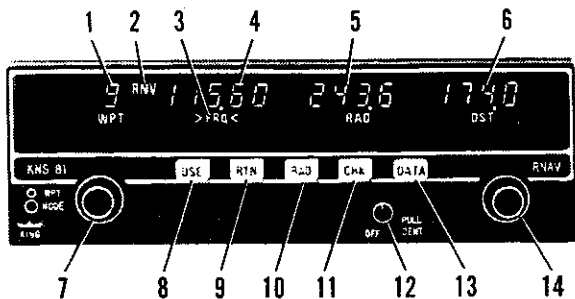
The KNS-81 includes storage for 10 waypoints and can be operated in any of three basic modes: VOR, RNAV, or ILS. In addition to the standard VOR and RNAV enroute modes, the KNS-81 has a constant course width VOR parallel mode and an RNAV approach mode. Distance, ground speed and time to the VORTAC or RNAV waypoint are displayed on the KDI-572 DME Indicator.

NOTE

An interlock is incorporated in the DME so that information from the other NAV receiver cannot be displayed on the DME when an RNAV mode is in use.

All operating controls and displays which are part of the KNS-81 are shown and described in Figure 1. All displays are in self-dimming gas discharge numerics. Pushbutton lighting intensity is controlled by the RADIO light dimming rheostat.

For additional descriptive information and operating details, consult the KNS-81 Pilot's Guide.



KI-206 VOR/LOC/ILS CDI

Figure 1. King Area Nav (Type KNS-81), King DME Control/Indicator (Type KDI-572) and Associated CDI Controls (Sheet 1 of 5)

1. **WAYPOINT DISPLAY (WPT)** - Displays waypoint number (0 to 9) of data being displayed. The WPT annunciator will flash whenever the displayed data is not the active waypoint data.
2. **VOR, PAR, RNV APR DISPLAYS** - System mode annunciators.
3. **CARETS DISPLAY (> <)** - Indicates which waypoint data (FRQ, RAD or DST) the increment/decrement rotary switch will change.
4. **FREQUENCY DISPLAY (FRQ)** - Displays frequency from 108.00 to 117.95 MHz in increments of .05 MHz.
5. **RADIAL DISPLAY (RAD)** Displays ground station radial on which waypoint is located from 0.0 to 359.9 degrees.
6. **DISTANCE DISPLAY (DST)** - Displays the offset distance of the waypoint from the ground station over a range of 0.0 to 199.0 NM.

RMI DISPLAY (Optional) (Not Shown) - Displays the bearing to the waypoint/station. Consult the RMI Supplement 33 in Section 9 of this handbook for additional information.
7. **WAYPOINT/MODE (WPT/MODE) CONTROL** dual concentric knobs -
 - a. The outer knob selects the **MODE** of unit operation. Turning the knob clockwise causes the mode to sequence thru VOR, VOR PAR, RNV, RNV APR and then back to the VOR mode.
 - b. The center knob selects the **WPT** to be displayed. Turning the knob causes the displayed waypoint to increment by one thru the waypoint sequence of 1,2,...9,0,1.
8. **USE BUTTON** - Momentary pushbutton which, when pressed, causes the active waypoint to take on the same value as the displayed waypoint.
9. **RETURN BUTTON (RTN)** - Momentary pushbutton which, when pressed, causes the active waypoint to return to the display.
10. **RADIAL BUTTON (RAD)** - Push on, push off button which, when pushed on, causes the remote DME to display the radial from station in VOR mode, or radial from waypoint in RNAV mode instead of KTS, and "F" (FROM) appears instead of MIN.
11. **CHECK BUTTON (CHK)** - Momentary pushbutton which, when pressed, causes the raw radio data from the NAV Receiver and DME to be displayed. The radial from the VOR ground station will be displayed on the RAD display and the distance from the station will be displayed on the DST display. There is no effect on any other data output.
12. **OFF/PULL ID CONTROL** - Rotary switch/potentiometer which, when turned clockwise, applies power to the KNS-81 and increases NAV audio level. The switch may be pulled out to hear VOR ident.

Figure 1. King Area Nav (Type KNS-81), King DME Control/Indicator (Type KDI-572) and Associated CDI Controls (Sheet 2 of 5)

13. DATA BUTTON - Momentary pushbutton which, when pressed, causes the caret (> <) display to change from FRQ to RAD to DST and back to FRQ.
14. DATA INPUT CONTROL - Dual concentric knobs with the center knob having an "in" and "out" position.

FREQUENCY DATA: The outer knob varies the frequency from 108 to 117 MHz in 1 MHz steps. The center knob varies frequency from .00 to .95 MHz in .05 MHz steps with the knob in its "in" and "out" position.

RADIAL DATA: The outer knob varies the tens digit with a carryover occurring from the tens to hundreds position. The center knob in the "in" position varies the units digit and in the "out" position varies the tenths digit.

DISTANCE DATA: The outer knob varies the tens digit with a carryover occurring from the tens to hundreds place. The center knob in the "in" position varies the units digit and in the "out" position varies the tenths digit.

15. DISTANCE DISPLAY - DME distance to VORTAC/WAYPOINT displayed in .1 nautical mile increments up to 99.9 NM, then in increments of one nautical mile to 389 NM.
16. SELECTED MODE ANNUNCIATOR - Displays the DME operating MODE; NAV 1 (1); NAV 2 (2); NAV 1 HOLD (1H); NAV 2 HOLD (H2) of the mode selector switch (20).
17. GROUND SPEED DISPLAY - Displays ground speed up to 999 knots. Ground speed is accurate only when flying directly to or from the station (VOR mode) or waypoint (RNAV mode).
18. RNAV ANNUNCIATOR (RNV) - Indicates RNV when displayed data is in relation to the RNAV waypoint. If the wrong DME mode is selected during RNAV operation, the RNV annunciator will flash.
19. TIME-TO-STATION/WAYPOINT DISPLAY - Displays time-to-station (VOR mode) or time-to-waypoint (RNAV mode) up to 99 minutes. Time-to-station information is accurate only when flying directly to or from the station or waypoint.
20. DME MODE SELECTOR SWITCH - Applies power to the DME and selects DME operating modes as follows:

OFF: Turns the DME OFF.

Nav 1 (N1): Selects DME operation with No. 1 VHF navigation set; enables channel selection by NAV 1 frequency selector controls.

Figure 1. King Area Nav (Type KNS-81), King DME Control/Indicator (Type KDI-572) and Associated CDI Controls (Sheet 3 of 5)

HOLD (HLD): Selects DME memory circuit; DME remains channeled to station to which it was last channeled when HOLD was selected and will continue to display information relative to this channel. Allows both the NAV 1 and NAV 2 navigation receivers to be set to new operational frequencies without affecting the previously selected DME operation.

CAUTION

In the HOLD mode there is no annunciation of the VOR/DME station frequency. However, an annunciator, labeled "1H" or "H2", illuminates on the DME display to flag the pilot that the DME is in the HOLD mode. RNAV will be inoperative when on HOLD.

NAV 2 (N2): Selects DME operation with No. 2 VHF navigation set; enables channel selection by Nav 2 frequency selector switches. N2 must be selected for RNAV operation if connected to NAV 2. NAV 1 must be selected for RNAV operation if connected to NAV 1.

Brightness of the labels for this switch is controlled by the radio light dimming rheostat.

21. COURSE INDEX - Indicates selected VOR/RNAV course.
22. NAVIGATION FLAG (NAV) - When visible, red NAV flag indicates unreliable VOR/RNAV/LOC signals or improperly operating equipment. Flag disappears when a reliable VOR/RNAV/LOC signal is being received.
23. TO-FROM INDICATOR - Operates only with a VOR or RNAV signal. With usable VOR/RNAV signal, indicates whether selected course is "TO" or "FROM" station/waypoint. With usable localizer signal the indicator is not in view.
24. GLIDE SLOPE DEVIATION NEEDLE - Indicates deviation from ILS glide slope.
25. COURSE DEVIATION POINTER - Indicates course deviation from selected omni or RNAV course or localizer centerline.
26. RECIPROCAL COURSE INDEX - Indicates reciprocal or selected VOR/RNAV course.
27. OMNI BEARING SELECTOR (OBS) - Rotates OBS course card to select desired course.
28. OBS COURSE CARD - Indicates selected VOR/RNAV course under course index.
29. GLIDE SLOPE FLAG (GS) - When visible, red GS flag indicates unreliable glide slope signal or improperly operating equipment. Flag disappears when a reliable glide slope signal is being received.

Figure 1. King Area Nav (Type KNS-81), King DME Control/Indicator (Type KDI-572) and Associated CDI Controls (Sheet 4 of 5)

30. **BACK COURSE LIGHT (BC)** - The 1000 autopilot BC light (shown) will illuminate amber when a localizer frequency is selected as the active waypoint frequency and when back-course operation is selected by the BC (Back Course) mode selector pushbutton on the 1000 IFCS mode selector unit (if installed). BC light dimming is available by the RADIO light dimming rheostat.

CAUTION

When connected to NAV 2 and back-course operation is selected, the course (omni) deviation bar (25) on the CDI will reverse and cause the localizer signal to the autopilot to reverse for back-course operation. When connected to NAV 1, the HSI will not reverse but the localizer signal is reversed in the autopilot for back course operation.

Figure 1. King Area Nav (Type KNS-81), King DME Control/Indicator (Type KDI-572) and Associated CDI Controls (Sheet 5 of 5)

SECTION 2 LIMITATIONS

The following RNAV IFR approach limitation must be adhered to during airplane operation.

OPERATING LIMITATION:

1. IFR Approaches -- Follow approved published RNAV instrument procedures.

SECTION 3 EMERGENCY PROCEDURES

There is no change to the airplane emergency procedures when this avionic equipment is installed.

SECTION 4 NORMAL PROCEDURES

PREFLIGHT:

AREA NAVIGATION FUNCTIONAL TEST:

The following procedure applies only to airports equipped with, or in range of, a collocated VOR/DME station.

1. OFF/PULL IDENT Control -- TURN ON.
2. MODE Control -- SELECT VOR mode.
3. DME FUNCTION Switch -- SELECT N1 or N2 depending on system selected.
4. OBS Knob -- SET so needle is centered with "FROM" indication.
5. RAD Display -- ENTER a waypoint radial angle equal to the OBS value determined in step 2.
6. DST Display -- ENTER a waypoint distance equal to the indicated DME value.

7. **MODE CONTROL** -- SELECT RNV mode.

The KNS-81 is operating properly if the DME distance to waypoint is less than 1.0 NM and the course deviation needle is within a dot of being centered.

PROGRAMMING:

Pertinent information (waypoint number, station frequency, waypoint radial, and waypoint distance) for up to ten waypoints is entered into the memory. Programming may be completed prior to takeoff or during flight. Any combination of navigational facilities (RNAV waypoint, VOR/DME, ILS) may be loaded into the computer; however, it is desirable that each facility be numbered and loaded in the sequence in which it is to be used.

RNAV WAYPOINTS:

1. **OFF/PULL IDENT Control** -- TURN ON.
2. **WPT CONTROL Knob** -- SELECT waypoint 1. Turn the knob in either direction to get "1".
3. **DATA INPUT Control** -- SELECT frequency for waypoint 1.
4. **DATA Button** -- PRESS to move > < (caret) from FRQ to RAD.
5. **DATA INPUT Control** -- SELECT radial for waypoint 1.
6. **DATA Button** -- PRESS to move > < (caret) from RAD to DST.
7. **DATA INPUT Control** -- SELECT distance for waypoint 1.
8. **SEQUENCE 2 thru 7** -- REPEAT for all the waypoints desired up to a maximum of ten.

NOTE

VOR and ILS data are entered in a similar manner except, RAD and DST entries are not required.

INFLIGHT USE:

1. **OFF/PULL IDENT Control** -- PULL ON.
2. **DME FUNCTION Switch** -- SELECT N1 or N2 depending on system selected.
3. **WPT CONTROL Knob** -- ROTATE as required to select the desired waypoint number. The waypoint information (frequency, radial, and distance) associated with the WPT number will be displayed in their respective displays.
4. **WAYPOINT Display (WPT)** -- OBSERVE that WPT is blinking indicating that the waypoint is a preview waypoint and not the active waypoint.

5. DATA INPUT Control -- SET FRQ, RAD, and DST as desired if preview waypoint is to be modified.

NOTE

Only the displayed waypoint, whether it is the active waypoint or a preview waypoint, will be affected by the data input (FRQ, RAD, and DST) control.

6. RETURN Button (RTN) -- PRESS if it is desired to return the display to the active waypoint number.

NOTE

The waypoint control knob may also be manually rotated until the active waypoint number is again displayed in lieu of using the RTN pushbutton.

7. USE Button -- PRESS if it is desired to place preview (blinking WPT) waypoint in use as the active waypoint.
8. WAYPOINT DISPLAY (WPT) -- OBSERVE that WPT is not blinking, indicating that the active waypoint is now displayed.
9. MODE Control -- SELECT desired or appropriate navigation mode.
10. RADIAL Button (RAD) -- PRESS if the radial from the waypoint/station is desired. The radial will be displayed on the DME knots display along with an "F" on the DME time to station display.

NOTE

The radial switch (RAD) is not the momentary type, therefore, the switch must be pressed again for the normal DME information to be displayed.

11. OBS Knob -- SELECT desired course.
12. CHECK Button (CHK) -- PRESS if the raw VOR and DME data is desired. The radial from the VOR will be displayed in the RAD display and the DME distance to the VOR will be displayed in the DST display.

KNS-81 OPERATIONAL NOTES:

1. VOR MODE OPERATION -- VOR mode is selected by turning the MODE control knob until VOR is displayed to the left of the waypoint number. In VOR mode, the remote DME is automatically tuned when the KNS-81 is selected as the tuning source via the N1 or N2 position on the DME indicator. Upon lock-on, distance, ground speed and time to the VORTAC station is displayed on the DME display. The course

deviation indicator displays conventional angular crosstrack deviation from the selected course ($\pm 10^\circ$ full scale). During VOR mode operation, the RAD and DST displays show dashes.

2. VOR PARALLEL MODE OPERATION -- VOR PARALLEL mode is selected by turning the MODE control knob until VOR PAR is displayed to the left of the waypoint number. If the system is receiving valid signals from a collocated VOR-DME facility, this mode provides a constant course width irrespective of the distance from the VORTAC and normal DME information is displayed on the DME indicator. The course deviation indicator displays ± 5 NM full scale from the selected course. The RAD and DST displays show dashes during operation in the VOR PAR mode.

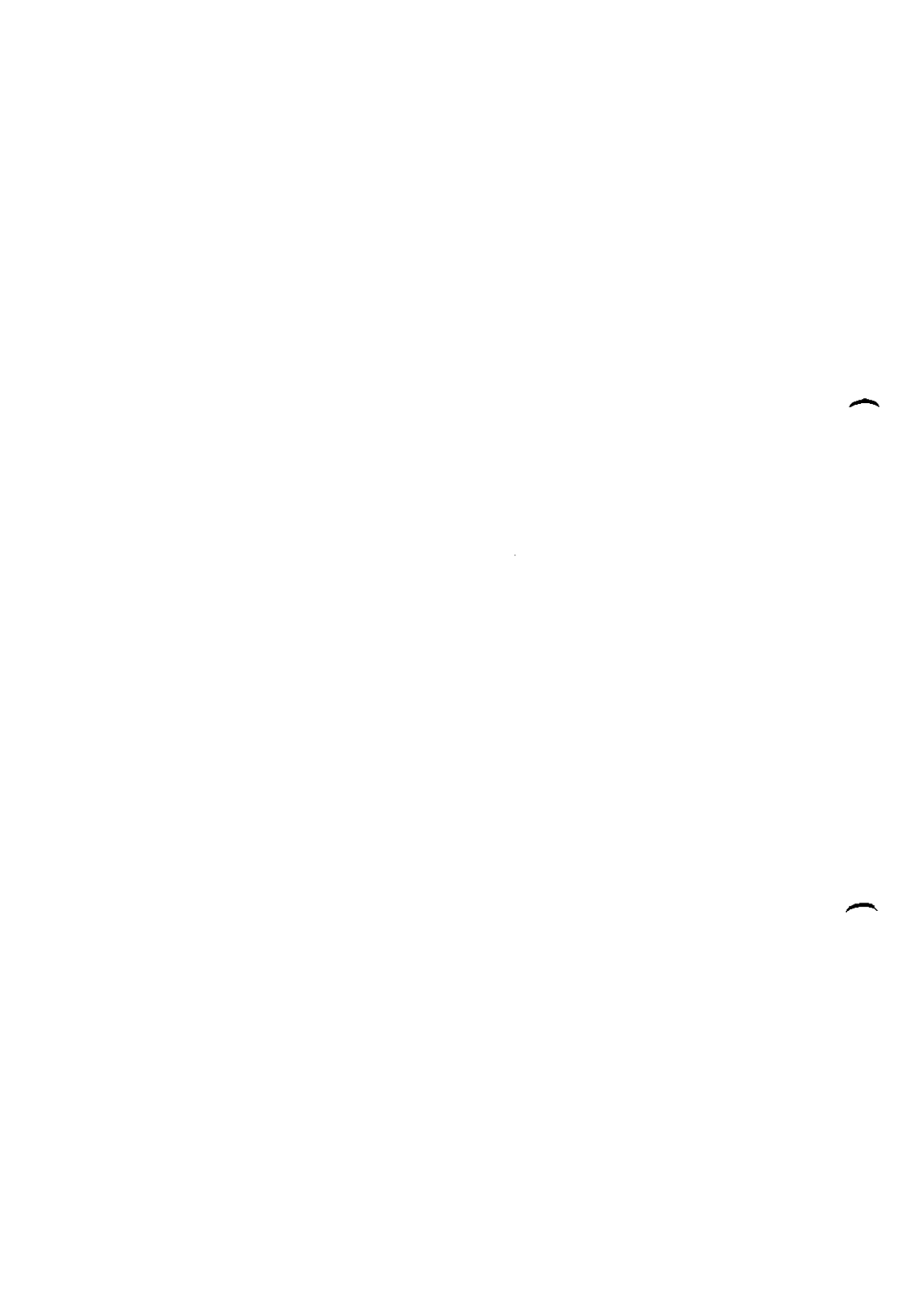
NOTE

- This mode of operation is primarily used when the pilot desires to fly a constant course width to either side of the selected VOR course. By flying a VOR parallel course, the pilot is able to stay up to a maximum of 5 NM to either side of the selected VOR course. The Sperry 1000 or IFCS autopilot will not track a VOR offset parallel course, but will track the selected base course in the parallel mode of operation.
 - It is recommended that either the VOR mode or RNV APR mode be used instead of the VOR PAR mode for approach. This procedure is recommended because the resolution of an off course indication increases with decreasing distance to the station in standard VOR mode and a tighter resolution of ± 1.25 NM exists in the RNV APR mode, but the resolution remains constant (± 5 NM full scale) in the VOR PAR mode.
3. ENROUTE RNAV MODE OPERATION -- ENROUTE RNAV MODE is selected by turning the MODE control knob until RNV is displayed to the right of the waypoint number. If the system is receiving valid signals from a collocated VOR-DME facility, this mode provides a constant course width and DME information to the waypoint. The course deviation indicator displays ± 5 NM full scale from the selected course.
 4. RNAV APPROACH MODE OPERATION -- RNAV APPROACH mode is selected by turning the MODE control knob until RNV APR is displayed to the right of the waypoint number. If the system is receiving valid signals from a collocated VOR-DME facility, this mode provides a constant course width and DME information to the waypoint. The course deviation indicator displays $\pm 1 \frac{1}{4}$ NM full scale from the selected course. For RNAV approaches, the RNV APR mode is normally selected prior to final approach course interception.

5. **ILS MODE OPERATION** -- ILS mode is selected by selecting an ILS frequency for the active waypoint frequency. Whenever an ILS frequency is the active waypoint frequency, the mode display remains the same (either VOR, VOR PAR, RNV or RNV APR) but the RAD and DST displays are blanked. Only conventional angular deviation is provided in the ILS mode (nominal full scale deviation from course centerline is $\pm 2.5^\circ$ for the localizer at most locations and $\pm 0.7^\circ$ for the glide slope). The course deviation pointer function can be reversed for back course (BC) operation by the BACK CRS mode selector pushbutton on the 1000 IFCS mode selector unit (if installed). Absence of the LOC/GS functions is annunciated by the NAV and GS flags in the CDI or HSI.

SECTION 5 PERFORMANCE

There is no change to the airplane performance when this avionic equipment is installed. However, the installation of an externally mounted antenna or several related external antennas, will result in a minor reduction in cruise performance.



SUPPLEMENT KING AUDIO CONTROL PANEL

(Type KMA-24H-70)

SECTION 1

GENERAL

The King Audio Control Panel (Type KMA-24H-70) is a compact solid state unit containing all operating controls on the front of the unit.

There are two control knobs on the far left of the panel for intercom control, ten push button switches on the top center of the panel for speaker audio control, ten push button switches on the bottom center of the panel for phone audio control and two control knobs on the far right of the panel for a multiple function Mic select switch and a speaker auto switch.

The electrical power required for operation of the audio control panel's headphone and/or speaker functions is supplied by RH AVIONICS BUS through a "pull-off" type circuit breaker labeled AUD PRI.

INTERPHONE (INTERCOM SYSTEM)

The interphone system consists of a hot mic volume control and an intercom VOX (Voice) sensitivity control which are controlled by the two control knobs on the far left of the panel. The inner control knob controls the intercom volume only and does not affect the other inputs. The outer control knob when rotated fully clockwise to the detent position provides hot mic operation. When rotated to the middle range, the control knob selects intercom VOX (voice) sensitivity and the rotation of this control knob adjusts the voice activated intercom audio level.

SPEAKER/PHONE (COM/NAV/DME/MKR & ADF) MONITOR PUSHBUTTONS

The audio panel incorporates in the center of the panel two rows of ten pushbutton switches, labeled SPEAKER on the top row and labeled PHONE on the bottom row. These pushbuttons permit the pilot or copilot to monitor the various communications and navigation systems available to the operator. When depressed, each pushbutton connects its respective navigation and/or communication system to either the speaker (top row of pushbuttons) or the headphones (bottom row of pushbuttons). To disconnect a communication or navigation system from either the speaker or headphones, depress the desired pushbutton a second time.

MIC SELECT SWITCH (INCLUDING EMG, PA & EXT POSITIONS)

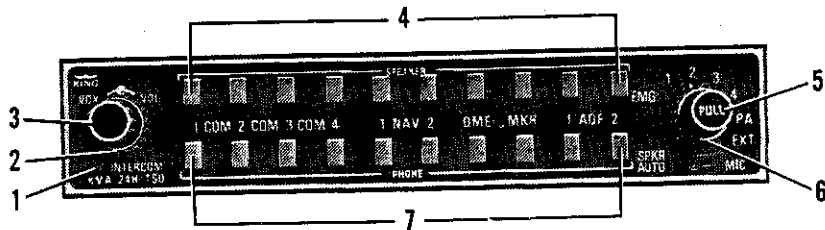
A multiple function MIC selector control switch is located on the far right of the panel and is the inner control knob. In the COM position (1 thru 4), microphone and audio keying are routed to the selected transceiver and the speaker amplifier is connected to the cockpit speaker. In the PA position, keyed microphone audio is routed to the aft cabin speakers for passenger address. The EXT (external ramp hail speaker) position is not used in this installation. In the EMG position, the microphone and headphones are connected directly to COM 1 as a means of failsafe communications in the event of a failure within the Audio Control Panel or on the RH AVIONICS BUS.

SPEAKER AUTO SELECT SWITCH

The SPKR AUTO selector control is located on the far right of the panel and is the outer control knob. When the SPKR AUTO switch is pulled out, it will automatically select the audio from the transceiver selected by the MIC select switch to be heard on the cockpit speaker.

**SECTION 2
LIMITATIONS**

There is no change to the airplane limitations when this avionic equipment is installed.



KMA-24H-70 AUDIO CONTROL PANEL

1. **VOX RELEASE ADJUSTMENT** - The VOX release pot is accessible through the small hole in the lower left corner of the front panel. Clockwise adjustment will increase the time that the intercom remains on after speech has ended. VOX release should be adjusted to suit user preference.
2. **INTERCOM VOX (VOICE) SENSITIVITY CONTROL** - Rotate knob to the fully clockwise detent position for hot mike operation. In the middle range, the switch selects VOX and the rotation of this knob also adjusts the sensitivity of the voice activated switch. In order to set the proper VOX sensitivity, first turn the VOX sensitivity control clockwise until a hissing sound is heard in the headphones. Next turn the control counterclockwise until the hissing sound stops. The VOX is now properly set for the present noise environment. It is normal to have to reset the VOX sensitivity level whenever the noise in the cockpit/cabin changes, such as when making large power changes.
3. **INTERCOM VOLUME CONTROL** - The inner concentric knob is the intercom volume control. This adjusts the intercom volume without affecting the volume of the selected receiver audio inputs. When either the pilot or copilot keys the microphone to transmit, all other intercom microphone inputs are muted to ensure that the keyed microphone is the single source of transmitted audio. All receiver inputs are also muted during transmissions.
4. **SPEAKER AUDIO SELECTOR BUTTONS (SPEAKER)** - Selector buttons for speaker audio output. When pressed in, enables operator to select any one or more audio signals. To disconnect, depress the pushbutton a second time.
5. **SPEAKER AUTO SWITCH** - When pulled out, automatically selects the audio from the transceiver selected by the MIC select switch to be heard on the cockpit speaker. Audio from the transceiver selected by the MIC select switch is always heard on the headphones.

Figure 1. King Audio Control System Operating Controls
(Sheet 1 of 2)

6. MIC SELECT SWITCH (Including EMG, PA and EXT Positions) - In the EMG (Emergency) position, microphone audio, microphone key and headphones are connected directly to COM 1. This provides failsafe communications in the event of Audio Panel Failure. In COM positions (1 thru 4), microphone audio and keying is connected to the appropriate transmitter and audio from the selected receiver will be heard on the speaker when the AUTO SPKR knob is pulled out. In the PA position, keyed microphone audio is routed to the aft cabin speakers for passenger address. The EXT position is nonfunctional in this installation. During transmit all received audio is muted and sidetone from the selected transmitter is heard on speaker and phones.
7. HEADPHONES AUDIO SELECTOR BUTTONS (PHONE) - Selector buttons for headphone audio output. When pressed in, enables headphone operation to any one or more audio signals. To disconnect, depress the pushbutton(s) a second time.

Figure 1. King Audio Control System Operating Controls
(Sheet 2 of 2)

SECTION 3

EMERGENCY PROCEDURES

There is no change to the airplane emergency procedures when this avionic equipment is installed.

NOTE

- This type of audio control panel has independent circuits for speaker and headphone functions. Thus, one failure does not cause the loss of both headphone and speaker audio. In case of failure to transmit over the headset MIC, the operator may still be able to transmit using the hand-held MIC. (The hand mike jack is connected in parallel with the copilot's headset jack. For better modulation and less background noise, unplug the copilot's headset when using the hand-held MIC.)
- If a complete failure of the audio control panel occurs, place the MIC select switch in the EMG position. The microphone and headphones will be connected directly to COM 1 as a means of failsafe communications.

SECTION 4 NORMAL PROCEDURES

AUDIO CONTROL PANEL OPERATIONS:

1. MIC Select Switch -- SELECT desired communications transceiver (COM 1, 2, 3 or 4 position) for transmitting.
2. SPEAKER and/or PHONE Audio Select Button(s) -- SELECT the COM/NAV System desired, to monitor audio over either the speaker (top row of pushbuttons) or the headphones (bottom row of pushbuttons).
3. SPEAKER AUTO Selector Knob -- PULL OUT for automatic speaker audio on selected communications receiver.
4. Transceiver and/or Receiver Audio Control -- ADJUST to desired listening level.
5. Interphone INTERCOM VOL Control -- ADJUST to desired listening level while using hot mic.
6. INTERCOM VOX (voice) Sensitivity Control -- ROTATE CONTROL knob clockwise to the middle range and then adjust as required for desired voice activation of hot mic intercom.

SECTION 5 PERFORMANCE

There is no change to the airplane performance when this avionic equipment is installed.

)

)

SUPPLEMENT KING DIGITAL ADF

(Type KR-87)

SECTION 1

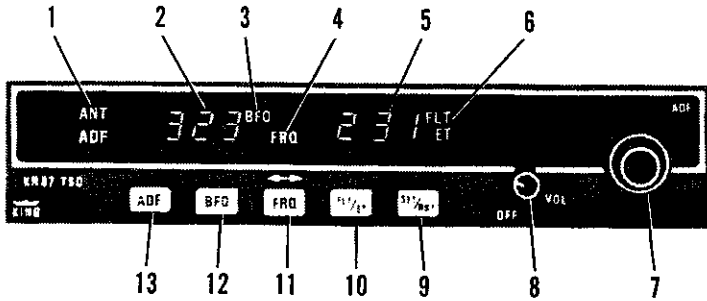
GENERAL

The King Digital ADF is a panel-mounted, digitally tuned automatic direction finder. It is designed to provide continuous 1-kHz digital tuning in the frequency range of 200-kHz to 1799-kHz and eliminates the need for mechanical band switching. The system is comprised of a receiver, a built-in electronic timer, a bearing indicator, and a KA-44B combined loop and sense antenna. Depending on the avionics options installed, the indicator can be a KI-227, KI-228 or KI-229. Operating controls and displays for the King Digital ADF are shown and described in Figure 1. The audio system used in conjunction with this radio for speaker-phone selection is shown and described in Supplement 26 in Section 9 of this handbook.

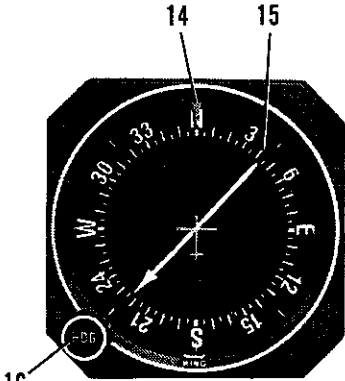
The King Digital ADF can be used for position plotting and homing procedures, and for aural reception of amplitude-modulated (AM) signals.

The "flip-flop" frequency display allows switching between preselected "STANDBY" and "ACTIVE" frequencies by pressing the frequency transfer button. Both pre-selected frequencies are stored in a non-volatile memory circuit (no battery power required) and displayed in self-dimming gas discharge numerics. The active frequency is continuously displayed in the left window, while the right window will display either the standby frequency or the selected readout from the built-in electronic timer.

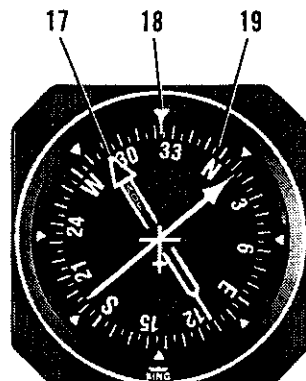
The built-in electronic timer has two separate and independent timing functions. An automatic flight timer that starts whenever the unit is turned on. This timer functions up to 59 hours and 59 minutes. An elapsed timer which will count up or down for up to 59 minutes and 59 seconds. When a preset time interval has been programmed and the countdown reaches :00, the display will flash for 15 seconds. Since both the flight timer and elapsed timer operate independently, it is possible to monitor either one without disrupting the other. The pushbutton controls and the bearing indicators are internally lighted. Intensity is controlled by the radio light dimming rheostat.



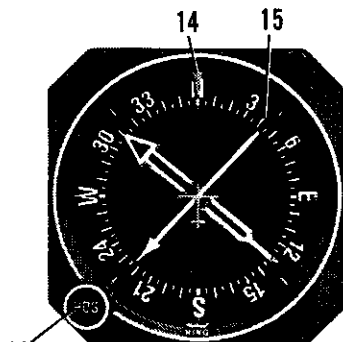
KR-87 ADF RECEIVER



KI-227 INDICATOR



KI-229 OPTIONAL RMI INDICATOR



KI-228 INDICATOR

Figure 1. King Digital ADF Operating Controls and Indicators
(Sheet 1 of 3)

1. **MODE ANNUNCIATION** Antenna (ANT) is selected by the "out" position of the ADF button. This mode improves the aural reception and is usually used for station identification. The bearing pointer is deactivated and will park in the 90° relative position. Automatic Direction Finder (ADF) mode is selected by the depressed position of the ADF button. This mode activates the bearing pointer. The bearing pointer will point in the direction of the station relative to the airplane heading.
2. **ACTIVE FREQUENCY DISPLAY** - The frequency to which the ADF is tuned is displayed here. The active ADF frequency can be changed directly when either of the timer functions are selected.
3. **BEAT FREQUENCY OSCILLATOR (BFO)** - The BFO mode, activated and annunciated when the "BFO" button is depressed, permits the carrier wave and associated morse code identifier broadcast on the carrier wave to be heard.

NOTE

CW signals (Morse Code) are unmodulated and no audio will be heard without use of BFO. This type of signal is not used in the United States air navigation. It is used in some foreign countries and marine beacons.

4. **STANDBY FREQUENCY ANNUNCIATION (FRQ)** - When FRQ is displayed the STANDBY frequency is displayed in the right hand display. The STANDBY frequency is selected using the frequency select knobs. The selected STANDBY frequency is put into the ACTIVE frequency window by pressing the frequency transfer button.
5. **STANDBY FREQUENCY DISPLAY** - Either the standby frequency, the flight timer, or the elapsed time is displayed in this position. The flight timer and elapsed timer are displayed replacing the standby frequency which goes into "blind" memory to be called back at any time by depressing the FRQ button. Flight time or elapsed time are displayed and annunciated alternatively by depressing the FLT/ET button.
6. **TIMER MODE ANNUNCIATION** - Either the elapsed time (ET) or flight time (FLT) mode is annunciated here.
7. **FREQUENCY SELECTOR KNOBS** - Selects the standby frequency when FRQ is displayed and directly selects the active frequency whenever either of the timer functions is selected. The frequency selector knobs may be rotated either clockwise or counterclockwise. The small knob is pulled out to tune the 1's. The small knob is pushed in to tune the 10's. The outer knob tunes the 100's with rollover into the 1000's. These knobs are also used to set the desired time when the elapsed timer is used in the countdown mode.
8. **OFF/VOLUME CONTROL (OFF/VOL)** - Controls primary power and audio output level. Clockwise rotation from OFF position applies primary power to receiver; further clockwise rotation increases audio level. Audio muting causes the audio output to be muted unless the receiver is locked on a valid station.

Figure 1. King Digital ADF Operating Controls and Indicators
(Sheet 2 of 3)

9. SET/RESET BUTTON (SET/RST) - The set/reset button when pressed resets the elapsed timer whether it is being displayed or not.
10. FLIGHT TIME/ELAPSED TIME MODE SELECTOR BUTTON (FLT/ET) - The Flight Timer/Elapsed Time mode selector button when pressed alternately selects either Flight Timer mode or Elapsed Timer mode.
11. FREQUENCY TRANSFER BUTTON (FRQ) - The FRQ transfer button when pressed exchanges the active and standby frequencies. The new frequency becomes active and the former active frequency goes into standby.
12. BFO BUTTON - The BFO button selects the BFO mode when in the depressed position. (See note under item 3.)
13. ADF BUTTON - The ADF button selects either the ANT mode or the ADF mode. The ANT mode is selected with the ADF button in the out position. The ADF mode is selected with the ADF button in the depressed position.
14. INDEX (ROTATABLE CARD) - Indicates relative, magnetic, or true heading of airplane, as selected by HDG control.
15. POINTER - Indicates station bearing in degrees of azimuth, relative to the nose of the airplane. When heading control is adjusted, indicates relative, magnetic, or true bearing of radio signal.
16. HEADING CARD CONTROL (HDG) - Rotates card to set in relative, magnetic, or true bearing information.
17. DOUBLE-BAR POINTER - Indicates bearing of selected ADF station.
18. HEADING INDEX - Indicates the airplane magnetic heading on the azimuth card.
19. ROTATING AZIMUTH CARD - Slaved to remote heading source; rotates as the airplane turns so that the airplane magnetic heading is continuously displayed at the heading index.

Figure 1. King Digital ADF Operating Controls and Indicators
(Sheet 3 of 3)

**SECTION 2
LIMITATIONS**

There is no change to the airplane limitations when this avionic equipment is installed.

**SECTION 3
EMERGENCY PROCEDURES**

There is no change to the airplane emergency procedures when this avionic equipment is installed.

**SECTION 4
NORMAL PROCEDURES****TO OPERATE AS AN AUTOMATIC DIRECTION FINDER:**

1. OFF/VOL Control -- ON.
2. Frequency Selector Knobs -- SELECT desired frequency in the standby frequency display.
3. FRQ Button -- PRESS to move the desired frequency from the standby to the active position.
4. ADF SPEAKER/PHONE Selector Pushbutton(s) Switch (on audio control panel) -- SELECT as desired.
5. OFF/VOL Control -- SET to desired volume level.
6. ADF Button -- SELECT ADF mode and note relative bearing on indicator.

ADF TEST (PRE-FLIGHT or IN-FLIGHT):

1. ADF Button -- SELECT ANT mode and note pointer moves to the 90° position.
2. ADF Button -- SELECT ADF mode and note pointer moves without hesitation to the station bearing. Excessive pointer sluggishness, wavering or reversals indicate a signal that is too weak or a system malfunction.

TO OPERATE BFO:

1. OFF/VOL Control -- ON.
2. BFO Button -- PRESS on.

3. ADF SPEAKER/PHONE Selector Buttons (on audio control panel) -- SET to desired mode.
4. VOL Control -- ADJUST to desired listening level.

NOTE

A 1000-Hz tone and Morse Code identifier is heard in the audio output when a CW signal is received.

TO OPERATE FLIGHT TIMER:

1. OFF/VOL Control -- ON.
2. FLT/ET Button -- PRESS (once or twice) until FLT is annunciated. Timer begins counting at takeoff and "holds" at touchdown.
3. OFF/VOL Control -- OFF and then ON if it is desired to reset the flight timer.

TO OPERATE AS A COMMUNICATIONS RECEIVER ONLY:

1. OFF/VOL Control -- ON.
2. ADF Button -- SELECT ANT mode.
3. Frequency Selector Knobs -- SELECT desired frequency in the standby frequency display.
4. FRQ Button -- PRESS to move the desired frequency from the standby to the active position.
5. ADF SPEAKER/PHONE Selector Buttons (on audio control panel) -- SET to desired mode.
6. VOL Control -- ADJUST to desired listening level.

TO OPERATE ELAPSED TIME TIMER-COUNT UP MODE:

1. OFF/VOL Control -- ON.
2. FLT/ET Button -- PRESS (once or twice) until FLT is annunciated.
3. SET/RST Button -- PRESS until the ET annunciation begins to flash.
4. SET/RST Button -- PRESS to start timer.
5. SET/RST Button -- PRESS to stop timer. Timer will reset zero. When the SET/RST button is released the timer will start to count again unless the SET/RST button is held until the ET annunciation flashes.

NOTE

The Standby Frequency which is in memory while Flight Time or Elapsed Time modes are being displayed may be called back by pressing the FRQ button, then transferred to active use by pressing the FRQ button again.

TO OPERATE ELAPSED TIME TIMER-COUNT DOWN MODE:

1. OFF/VOL Control -- ON.
2. FLT/ET Button -- PRESS (once or twice) until ET is annunciated.
3. SET/RST Button -- PRESS until the ET annunciation begins to flash.
4. FREQUENCY SELECTOR KNOBS -- SET desired time in the elapsed time display. The small knob is pulled out to tune the 1's. The small knob is pushed in to tune the 10's. The outer knob tunes minutes up to 59 minutes.

NOTE

Selector knobs remain in the time set mode for 15 seconds after the last entry or until the SET/RST, FLT/ET or FRQ button is pressed.

5. SET/RST Button -- PRESS to start countdown. When the timer reaches 0, it will start to count up as display flashes for 15 seconds.

NOTE

While FLT or ET are displayed, the active frequency on the left side of the window may be changed, by using the frequency selector knobs, without any effect on the stored standby frequency or the other modes.

ADF OPERATIONAL NOTES:**ERRONEOUS ADF BEARING DUE TO RADIO FREQUENCY PHENOMENA:**

In the United States, the FCC, which assigns AM radio frequencies, occasionally will assign the same frequency to more than one station in an area. Certain conditions, such as Night Effect, may cause signals from such stations to overlap. This should be taken into consideration when using AM broadcast station for navigation.

Sunspots and atmospheric phenomena may occasionally distort reception so that signals from two stations on the same frequency will overlap. For this reason, it is always wise to make positive identification of the station being tuned, by switching the function selector to ANT and listening for station call letters.

ELECTRICAL STORMS:

In the vicinity of electrical storms, an ADF indicator pointer tends to swing from the station tuned toward the center of the storm.

NIGHT EFFECT:

This is a disturbance particularly strong just after sunset and just after dawn. An ADF indicator pointer may swing erratically at these times. If possible, tune to the most powerful station at the lowest frequency. If this is not possible, take the average of pointer oscillations to determine relative station bearing.

MOUNTAIN EFFECT:

Radio waves reflecting from the surface of mountains may cause the pointer to fluctuate or show an erroneous bearing. This should be taken into account when taking bearings over mountainous terrain.

COASTAL REFRACTION:

Radio waves may be refracted when passing from land to sea or when moving parallel to the coastline. This also should be taken into account.

**SECTION 5
PERFORMANCE**

There is no change to the airplane performance when this avionic equipment is installed. However, the installation of an externally mounted antenna or related external antennas, will result in a minor reduction in cruise performance.

SUPPLEMENT KING DIGITAL COMM

(Type KY-196)

SECTION 1

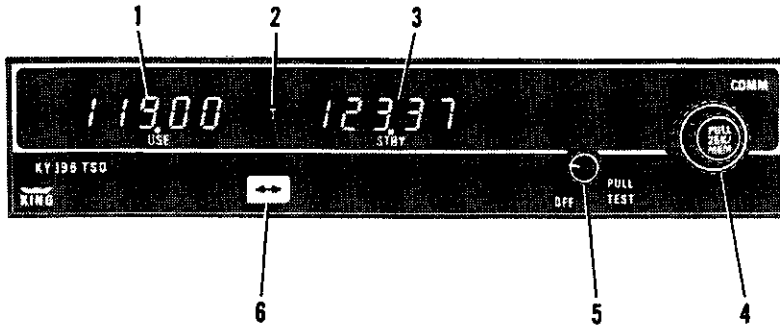
GENERAL

The King KY-196 Digital Comm, Shown in Figure 1, consists of a panel-mounted receiver-transmitter. The set includes a 720-channel VHF communications receiver-transmitter which receives and transmits signals between 118.000 and 135.975 MHz with 25-kHz spacing.

The KY-196 has four modes of operation: Frequency mode; Channel mode; Channel Programming mode; Direct Tuning mode. The Frequency mode of operation allows the pilot to tune a frequency in the standby frequency display and then "flip-flop" the standby and active frequencies. The Channel mode allows up to nine frequencies and the corresponding Channel numbers to be recalled from memory. The Channel number is momentarily displayed in the active (USE) frequency display and the corresponding frequency is displayed in the STANDBY frequency display. The Channel Programming mode allows the pilot to program in frequencies for use in the Channel mode of operation. The Direct Tuning mode is a back-up mode which allows frequency changes to be made directly into the active frequency display.

Large self-dimming gas discharge readouts display the communications operating frequencies. The KY-196's unique "flip-flop" pre-select feature enables you to store one frequency in the standby display while operating on another and then interchange them instantly with the touch of a button. Both the active (USE) and the standby frequencies are stored in a circuit component called EAROM (Electrically Alterable Read Only Memory) that provides non-volatile storage of frequencies and programmed channels so that when the radio is turned off and then back on, channel information is retained.

The COMM incorporates an automatic squelch. To override the automatic squelch, the volume control knob is pulled out. Push the knob back in to re-activate the automatic squelch.



1. OPERATING COMM FREQUENCY DISPLAY (USE) - Displays active communication frequency or the channel number when selecting or programming channels.
2. TRANSMIT INDICATOR - "T" appears to indicate that the transceiver is in the transmit mode.
3. STANDBY COMM FREQUENCY DISPLAY (STANDBY) - Displays standby communication frequency or during channel programming the programmed frequency is displayed.
4. MODE FREQUENCY/CHANNEL SELECTOR:
 - a. FREQUENCY MODE - The outer, larger selector knob is used to change the MHz portion of the frequency display; the small knob changes the kHz portion. This smaller knob is designed to change the indicated frequency in steps of 50-kHz when it is pushed in, and in 25-kHz steps when it is pulled out. At either band-edge of the 118-135 MHz frequency spectrum, an offscale rotation will wrap the display around the other frequency band-edge (i.e., 135 MHz advances to 118 MHz).
 - b. CHANNEL MODE - The small knob when pulled out selects channels 1 thru 9. Channel numbers without a programmed frequency will be skipped. The selected Channel number will be displayed for approximately 2 seconds in active frequency display and the corresponding programmed frequency is displayed in the standby frequency display. The outer, larger selector knob and the smaller knob (when it is pushed in) function as described in "a", except that the smaller knob always changes the indicated frequency in 25-kHz steps.
 - c. CHANNEL PROGRAMMING MODE - The small knob when pulled out selects channels 0 thru 9.
 - (1) With Channel 0 displayed - The small knob when pushed in selects either --- which indicates operation in the Frequency mode or UUU which indicates operation in the Channel mode.

Figure 1. King KY-196 Tranceiver (Sheet 1 of 2)

(2) With a Channel Number 1 thru 9 displayed - With small knob pushed in, selects the frequency in the standby display in 25 KHz steps. The outer, larger selector knob functions as described in "a".

d. DIRECT-TUNING MODE - The knobs function as described in "a".

5. COMM VOLUME CONTROL (OFF/PULL TEST) - Rotary switch/potentiometer which, when turned clockwise, applies power to the KY-196 and adjusts volume of communication receiver audio. When pulled out disables automatic squelch and allows background noise to be heard to verify squelch test.
6. COMM FREQUENCY TRANSFER BUTTON (←→) - Interchanges the frequencies in the USE and STANDBY displays. When pressed and held depressed for 3 seconds, selects the Channel Programming mode. When held depressed while the radio power is turned on, selects the Direct-Tuning mode.

Figure 1. King KY-196 Tranceiver (Sheet 2 of 2)

All controls for the King KY-196 are mounted on the front panel of the receiver-transmitter. Control lighting is provided by the instrument panel flood lighting system. Operation and description of the audio control panel used in conjunction with this radio are shown and described in Supplement 26 in Section 9 of this handbook.

SECTION 2 LIMITATIONS

There is no change to the airplane limitations when this avionic equipment is installed.

SECTION 3 EMERGENCY PROCEDURES

There is no change to the airplane emergency procedures when this avionic equipment is installed. However, if the frequency readouts fail, the following procedure should be followed.

RADIO DISPLAY FAILURE:

1. COMM Volume Control (OFF/PULL TEST -- TURN counterclockwise to OFF position.
2. COMM Transfer Button (←→) -- PRESS and HOLD DEPRESSED.
3. COMM Volume Control (OFF/PULL TEST) -- TURN clockwise; pull out and adjust to desired audio level; push control back in to activate the automatic squelch.

NOTE

The radio is now in the Direct Tuning Mode. The active and standby frequencies are set to 120.00 MHz. The frequency selector knobs can be used to directly tune the active frequency.

4. MODE/FREQUENCY/CHANNEL Selector - The outer, larger selector knob will change the numbers to the left of the decimal one MHz per click. The smaller knob when pushed in changes the number to the right of the decimal 50 kHz per click and 25 kHz per click when pulled out. Therefore if the frequency 121.50 was desired, the larger knob would be turned one click clockwise and the smaller knob pushed in and turned 10 clicks either clockwise or counterclockwise.

SECTION 4

NORMAL PROCEDURES

OPERATING MODE SELECTION:

1. COMM Volume Control (OFF/PULL TEST) -- TURN clockwise until radio comes on.
2. COMM Transfer Button (←→) -- PRESS and HOLD DEPRESSED for three seconds.
3. MODE/FREQUENCY/CHANNEL Selector -- PULL OUT and ROTATE the small knob until zero (0) appears in the active frequency display.
4. MODE/FREQUENCY/CHANNEL Selector -- PUSH IN and ROTATE. Select either --- or UUU.

NOTE

When the MODE Selector knob is rotated, the standby frequency display will alternate between --- and UUU.

- a. The FREQUENCY Mode is selected when dashes (---) are displayed.
 - b. The CHANNEL Mode is selected when (UUU) is displayed.
5. COMM Transfer Button (←→) -- PRESS to return to the selected operating mode.

NOTE

After 20 seconds of no switch/selector activity, the unit will automatically return to the selected operating mode.

FREQUENCY MODE

COMMUNICATION RECEIVER-TRANSMITTER OPERATION:

1. MIC Selector Switch (on audio control panel) -- SET to this radio.
2. SPEAKER/PHONE Selector Buttons (on audio control panel) -- SET to this radio.
3. COMM Volume Control (OFF/PULL TEST) -- TURN clockwise; pull out and adjust to desired audio level; push control back in to activate the automatic squelch.
4. MODE/FREQUENCY/CHANNEL Selector Knobs -- SELECT desired operating frequency.
5. COMM Transfer Button (←→) -- PRESS to transfer desired frequency from the "STANDBY" display into the "USE" display.

6. Mike Button:
 - a. To Transmit -- DEPRESS and SPEAK into microphone.

NOTE

- During COMM transmission, a lighted "T" will appear between the "USE" and "STANDBY" displays to indicate that the transceiver is operating in the transmit mode.
 - Phone sidetone may be selected by pushing the AUTO selector button (on audio control panel) in the phone position.
- b. To Receive -- RELEASE mike button.

CHANNEL MODE

COMMUNICATION RECEIVER-TRANSMITTER OPERATION:

1. MIC Selector Switch (on audio control panel) -- SET to this radio.
2. SPEAKER/PHONE Selector Buttons (on audio control panel) -- SET to this radio.
3. COMM Volume Control (OFF/PULL TEST) -- TURN clockwise; pull out and adjust to desired audio level; push control back in to activate the automatic squelch.
4. MODE/FREQUENCY/CHANNEL Selector Knobs -- SELECT desired operating channel (Pull out and rotate smaller knob).

NOTE

The Channel number will be displayed in the active display and the corresponding programmed frequency in the standby display. The Channel number will only be displayed for approximately 2 seconds, after which the original active frequency will again be displayed.

5. COMM Transfer Button (← →) -- PRESS to transfer the programmed frequency from the "STANDBY" display into the "USE" display.
6. MIC Button:
 - a. To Transmit -- DEPRESS and SPEAK into microphone.

NOTE

- During COMM transmission, a lighted "T" will appear between the "USE" and "STANDBY" displays to indicate that the transceiver is operating in the transmit mode.

- Phone sidetone may be selected by pushing the AUTO selector button (on audio control panel) in the phone position.

CHANNEL PROGRAMMING MODE OPERATION:

1. COMM Transfer Button -- PRESS and HOLD depressed for three seconds.
2. MODE/FREQUENCY/CHANNEL Selector Knobs -- OPERATE as follows:
 - a. Small Knob -- PULL OUT and ROTATE until the desired channel number (1 thru 9) appears in the active display.
 - b. Small Knob -- PUSH IN.
 - c. Larger Knob -- ROTATE to select the MHz portion of the frequency.
 - d. Small Knob -- ROTATE to select the kHz portion of the frequency. In this mode, the frequency is changed in 25 kHz steps.
 - e. Larger Knob -- ROTATE to program in up to 9 channels; clockwise from 118 to --- or counterclockwise from 135 to ---. When operating in the CHANNEL mode, any channel whose corresponding frequency is --- will be skipped.
 - f. Small Knob and Larger Knob -- REPEAT the above, items a thru e, until all the desired channels are programmed.
3. COMM Transfer Button -- PRESS to return to the selected operating mode.

NOTE

- After 20 seconds of no switch/selector activity, the unit will automatically return to the selected operating mode.
- While in the Channel Programming mode the radio is still tuned to the active frequency which was active when the Channel Programming mode was entered.

DIRECT-TUNING MODE OPERATION:

1. COMM Volume Control (OFF/PULL TEST) -- TURN counterclockwise to OFF position.
2. COMM Transfer Button (←→) -- PRESS and HOLD DEPRESSED.

3. COMM Volume Control (OFF/PULL TEST) -- TURN clockwise until radio comes on.

NOTE

The radio is now in the DIRECT-TUNING mode. Both the active and standby frequencies are set to 120.0 MHz and the radio tuning set to the FREQUENCY mode of operation. When the MODE/FREQUENCY/CHANNEL selector knobs are rotated, the frequency change will be made directly into the active frequency display.

4. MODE/FREQUENCY/CHANNEL Selector -- ROTATE to directly select active frequency.
5. COMM Transfer Button (←→) -- PRESS whenever it is desired to return to the FREQUENCY mode of operation.

SECTION 5
PERFORMANCE

There is no change to the airplane performance when this avionic equipment is installed. However, this installation of an externally mounted antenna or several related external antennas, will result in a minor reduction in cruise performance.

SUPPLEMENT KING DME (Type KN-63) SECTION 1 GENERAL

The King DME (Type KN-63) is the airborne "interrogator" portion of a navigation system which supplies continuous, accurate, slant range distance information from a fixed ground station to an airplane in flight.

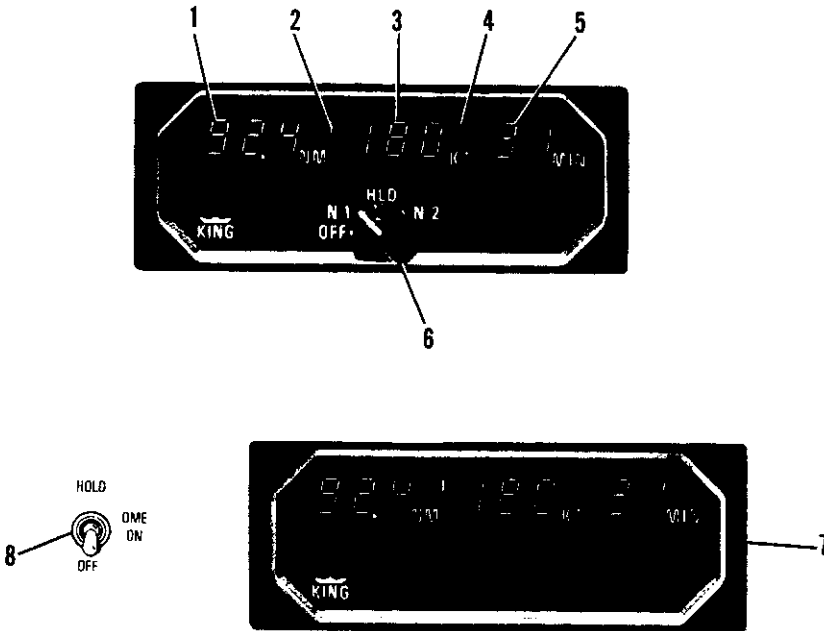
Except for selection of the operating channel, which is selected by the VHF navigation receiver frequency selector switches, the King DME is capable of independent operation. The equipment consists of a KDI-572 Panel Display which contains all of the operating controls and displays, a remotely mounted KN-63 Receiver-Transmitter and optional KDI-574 Panel Display for dual installation. The KN-63 transmits interrogating pulse pairs on 200 channels between 1041 MHz and 1150 MHz; it receives associated ground-to-air replies between 978 MHz and 1213 MHz. The KDI-572 and KDI-574 Panel Displays digitally displays distances in nautical miles, ground speed in knots, and time-to-station in minutes. All displays are in self-dimming gas discharge numerics. All operating controls and displays for the DME are shown in Figure 1, and the functions of each are described.

NOTE

An interlock is incorporated in the DME so that information from the other NAV receiver cannot be displayed on the DME when an RNAV mode is in use.

SECTION 2 LIMITATIONS

There is no change to the airplane limitations when this avionic equipment is installed.



1. DISTANCE DISPLAY (NM) - DME distance to VORTAC/WAYPOINT displayed in .1 nautical mile increments up to 99.9 NM, then in increments of one nautical mile to 389 NM.
2. DME MODE ANNUNCIATOR - Displays the DME operating mode; NAV 1 (1); NAV 2 (2), NAV 1 HOLD (1H); NAV 2 HOLD (H2); of the mode selector switch (6).
3. GROUND SPEED DISPLAY (KT) - Displays ground speed in knots to or from VORTAC/WAYPOINT up to 999 knots (airplane must be flying directly to or from the VORTAC/WAYPOINT for true ground speed indication).
4. RNAV ANNUNCIATOR (RNV) - Indicates RNV when displayed data is in relation to the RNAV waypoint. If the wrong DME mode is selected during RNAV operation, the RNV annunciator will flash.
5. TIME-TO-STATION DISPLAY (MIN) - Displays time-to-station (VORTAC/WAYPOINT) in minutes up to 99 minutes (airplane must be flying directly to or from the Vortac/Waypoint for true time-to-station indication).

Figure 1. KN-63 Control Functions (Sheet 1 of 2)

6. DME MODE SELECTOR SWITCH (OFF, N1, HLD, N2) - Applies power to the DME and selects DME operating mode as follows:

OFF: Turns DME power off.

NAV 1 (N1): Selects DME operation with NO. 1 VHF navigation set; enables channel selection by NAV 1 frequency selector controls.

HOLD (HLD): Selects DME memory circuit; DME remains channeled to station to which it was last channeled when HOLD was selected and will continue to display information relative to this channel. Allows both the NAV 1 and NAV 2 navigation receivers to be set to new operational frequencies without affecting the previously selected DME operation.

CAUTION

In the HOLD mode there is no annunciation of the VOR/DME station frequency. However, an annunciator, labeled "1H" or "H2", illuminates on the DME display to flag the pilot that the DME is in the HOLD mode.

- NAV 2 (N2): Selects DME operation with No. 2 VHF navigation set; enables channel selection by NAV 2 frequency selector switches. Brightness of the labels for this switch is controlled by the radio light dimming rheostat.
7. PANEL DISPLAY - 2nd display used with dual installation.
8. DME MODE SELECTOR SWITCH (OFF, ON, HOLD) - Selects DME operating mode for KDI-574 Panel Display.

Figure 1. KN-63 Control Functions (Sheet 2 of 2)

SECTION 3 EMERGENCY PROCEDURES

There is no change to the airplane emergency procedures when this equipment is installed.

SECTION 4 NORMAL PROCEDURES

DME OPERATION:

1. DME Mode Selector Switch -- SET to N1 or N2 for KDI-572 or ON for KDI-574.
2. NAV 1 and NAV 2 VHF Navigation Receivers -- ON; SET FREQUENCY selector switches to VOR/DME station frequencies, as required.

NOTE

When the VOR frequency is selected, the appropriate DME frequency is automatically channeled.

3. DME SPEAKER/PHONE selector buttons (on audio control panel) -- SET to desired mode.

SECTION 5 PERFORMANCE

There is no change to the airplane performance when this avionic equipment is installed. However, the installation of an externally mounted antenna, or several related external antennas, will result in a minor reduction in cruise performance.

SUPPLEMENT KING HF TRANSCEIVER

(Type KHF-950)

SECTION 1

GENERAL

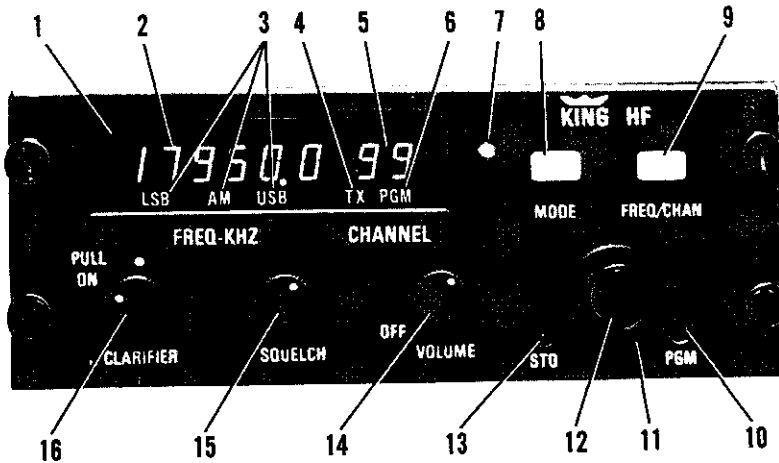
The King KHF-950 is a solid-state HF single sideband transceiver system providing the pilot access to 99 programmable channels plus 280,000 operating frequencies in the 2000 to 29,999.9 kHz range. It provides receive-only and simplex operation, as well as semi-duplex capability (transmission on one frequency, reception on another) to interface with maritime radio-telephone networks (public correspondence). The HF Transceiver system consists of a KCU-951 panel-mounted control display unit, a remote-mounted KAC-952 power amplifier/antenna coupler, a remote-mounted KTR-953 Receiver exciter and an external-mounted, fixed-wire, medium/high frequency antenna.

The KCU-951 Control Display Unit uses electronic gas discharge read outs to display frequency, channel and mode of operation. The 99 channels can be programmed by the pilot on the ground or in the air, and the nonvolatile memory stores this information even when the system is turned off. To add to the operational convenience, the antenna coupler will automatically tune the antenna to the specific frequency desired simply by keying the mic.

All operating controls for the KCU-951 Control Display Unit are shown and described in Figure 1. Refer to the King Audio Control Panel (Type KMA-24) shown and described in Supplement 26 in this section for the description of the HF microphone selector switch and HF SPEAKER/PHONE selector button used in conjunction with the KCU-951 Control Display Unit.

SECTION 2 LIMITATIONS

There is no change to the airplane limitations when this avionics equipment is installed.



"CURSOR" - (Not Shown) Refers to a flashing frequency digit. The cursor may be positioned left or right along the frequency display, digit by digit, using the outer concentric knob. The cursor is required to enable frequency changes in the direct tuning mode of operation or during channel programming. If the cursor is not visible, it is in its stowed position and may be retrieved using the outer concentric knob. Similarly, to stow the cursor, rotate the outer concentric knob left or right until the cursor disappears.

1. GAS DISCHARGE DISPLAY - Displays all frequencies, channel numbers and operating modes.
2. FREQUENCY DISPLAY - Frequencies from 2000.0 kHz to 29,999.9 kHz are annunciated.
3. EMISSION MODE DISPLAY - Emission mode annunciations LSB, AM and USB are displayed as selected. LSB (Lower Sideband) is usually disabled since it is not normally used in airborne HF applications.
4. TRANSMIT (TX) MODE DISPLAY - Annunciates when the MIC is keyed. A flashing TX annunciation accompanied by a blanking of the frequency display signifies that the KHF-950 System is in the automatic antenna tuning process.

When the TX stops flashing and the frequency display reappears, the transceiver is ready for use on that frequency. Always press the MIC button after selecting a new frequency to initiate antenna tuning. A flashing TX annunciation in the PGM mode signifies that the KHF-950 memory is ready to accept the transmit frequency. In the programming sequence, storing the transmit frequency always follows storage of the receive frequency.

5. CHANNEL DISPLAY - Channels 1 through 99 are annunciated.

Figure 1. King HF SSB Tranceiver (Type KHF-950)
(Sheet 1 of 3)

6. PROGRAM (PGM) MODE DISPLAY - Annunciates when the program mode is enabled through depression of the program (PGM) switch.
7. PHOTOCELL - Dims display automatically.
8. MODE BUTTON - Momentary depression cycles the KHF-950 emission mode from upper sideband (USB) to lower sideband (LSB) to AM to A3A (simultaneous display of "AM" and "USB"). Single sideband "reduced" carrier operation (A3A) is normally not enabled by the installer. A3A was previously used in maritime radio telephone but is not used currently. Similarly, LSB is not normally authorized for airborne HF use and is not enabled by the installer. Most all airplane HF SSB Communications are conducted in USB (also referred to as single sideband "suppressed" carrier and designated A3J). Some ground stations continue to use the AM mode but are being phased out in favor of the more efficient SSB mode of operation.
9. FREQ/CHAN BUTTON - In the "out" position, allows direct tuning to any of 280,000 available frequencies (simplex operation only). In the "in" position allows selection of any of 99 available channels of programmed pairs of receive and transmit frequencies (simplex, semi-duplex and receive-only operation).
10. PROGRAM (PGM) SWITCH - Momentary depression (with a pencil or similar pointed object) enables the program mode. PGM will appear in the display. Similarly a second depression of the switch will cause the KHF-950 to exit the program mode.
11. OUTER CONCENTRIC KNOB - Causes the cursor to move left or right, one digit at a time along the frequency display. To remove (or stow) the cursor, twist the knob left or right until the cursor disappears.
12. INNER CONCENTRIC KNOB - May be rotated to (1) change channels or (2) change the digit under the cursor in the frequency display. In order to change channels, the FREQ/CHAN button must be in the "in" position (Channel Operation) and the cursor must be stowed. Prior to changing a frequency digit (Direct Tune Operation or during Channel Programming), the cursor must be moved to that digit.
13. STORE (STO) SWITCH - Momentary depression (with a pencil or similar pointed object) stores the emission mode (i.e. LSB, AM, USB) and the frequency into non-volatile memory. In the normal channel programming sequence the first set of data stored is the "receive" emission mode and frequency. After the receive data is stored, the TX annunciation will flash signifying the system's readiness to accept the transmit frequency. A second momentary depression of the STO switch stores the desired transmit frequency in nonvolatile memory. Note that prior to selecting another channel to program, (1) you may choose **receive-only** mode of operation by simply not depressing the STO switch a second time (thus locking out the transmitter for receiving say WWV), or (2) you may choose **simplex** operation by depressing the STO switch a second time storing the same frequency in the transmit position as was stored in the receive position, or (3) you may wish to choose **semi-duplex** operation and change the transmit frequency prior to depressing the STO switch a second time. (In order to change channels upon completion of data storage, the cursor must be stowed. This will occur automatically upon depressing the STO switch the second time; however, in the case of receive-only programming where the STO switch is not depressed the second time, the cursor must be stowed manually using the outer concentric knob.)

Figure 1. King HF SSB Transceiver (Type KHF-950)
(Sheet 2 of 3)

14. OFF/VOLUME KNOB - Turns system on and adjusts audio volume.
15. SQUELCH KNOB - Squelch is set by rotating the knob clockwise until background noise can be heard and then turning it counterclockwise until the background noise is eliminated or just barely audible. Since HF signals are many times only marginally strong, it is usually necessary to leave the squelch knob fully clockwise to maintain satisfactory reception. For this reason, SELCAL (Selective Calling) may be a desirable option to relieve fatigue from background noise on extended flights.
16. CLARIFIER KNOB - When pulled out, the clarifier knob may be rotated to adjust the receiver frequency in SSB operation to improve the speech quality received. The clarifier knob is unique to SSB operation and is not used in AM operation. When the knob is pushed in, the clarifier has no effect. When voice quality is good and natural, the clarifier knob should remain pushed in.

Figure 1. King HF SSB Transceiver (Type KHF-950)
(Sheet 3 of 3)

SECTION 3 EMERGENCY PROCEDURES

There is no change to the airplane emergency procedures when this avionics equipment is installed.

INTERNATIONAL DISTRESS FREQUENCY. The frequency 2182 kHz on USB emission mode has been designated as an International Distress Frequency. It is monitored worldwide and should be used only in the case of an actual emergency. If repeated calls on 2182 kHz do not bring a response, the flight crew may wish to try the U.S. Coast Guard on the following channels:

USCG CHANNELS/FREQUENCIES (USB emission mode)

| ITU Channel No. | Aircraft Receive (kHz) | Aircraft Transmit (kHz) |
|--------------------|---------------------------|----------------------------|
| 424 | 4428.7 | 4134.3 |
| 601 | 6506.4 | 6200.0 |
| 816 | 8765.4 | 8241.5 |
| 1205 | 13113.2 | 12342.4 |
| 1625 | 17307.3 | 16534.4 |

If the Coast Guard cannot be contacted on one of these channels/frequencies, try a maritime radiotelephone (public correspondence) operator channel.

SECTION 4 NORMAL PROCEDURES

PREFLIGHT INSPECTION:

WARNING

WHEN PERFORMING A KHF-950 RADIO CHECK ON THE GROUND, MAKE CERTAIN THAT ALL PERSONNEL ARE CLEAR OF THE HF ANTENNA BEFORE TRANSMITTING. SERIOUS RF BURNS CAN RESULT FROM DIRECT CONTACT WITH THE ANTENNA OR ANTENNA TERMINAL WHEN THE SYSTEM IS TRANSMITTING.

1. Antenna -- CHECK structural integrity.
2. MIC (Microphone) Selector Switch (on audio control panel) -- SELECT HF position.
3. HF SPEAKER/PHONE Selector Buttons (on audio control panel) -- PRESS desired mode.
4. OFF/VOLUME Control Knob -- TURN ON.
5. Authorized Channel or Frequency -- SELECT.
6. Mike Button (on control wheel) -- PRESS. The TX annunciation should flash and the frequency display blank as the antenna coupler tunes the antenna. When the tuning sequence is complete, the TX stops flashing and the frequency display reappears.
7. Radio Check -- TRANSMIT and RECEIVE on usable frequency.

NOTE

If the KHF-950 detects a fault during transmission or during the tuning of the antenna, the frequency digits will begin to flash. Simply key the mike and the automatic antenna coupler will begin a new tuning cycle to clear the fault. If repeated antenna tuning cycles fail to clear the fault there is probably an equipment malfunction. If practical, attempt to retune the antenna on an alternate frequency.

CHANNEL PROGRAMMING:

1. OFF/VOLUME Control Knob -- TURN ON.
2. FREQ/CHAN Button -- "IN" position for channel operation. Note the channel number annunciation in the display.
3. PGM Switch -- DEPRESS. Note PGM annunciated in the display.

4. Outer Concentric Knob -- ROTATE to stow cursor.
5. Inner Concentric Knob -- ROTATE to select desired channel number.
6. MODE BUTTON -- PRESS. Repeat until desired emission mode is annunciated.
7. Outer Concentric Knob -- ROTATE to position cursor over receive frequency digit to be changed.
8. Inner Concentric Knob -- ROTATE to set desired number under the cursor.

NOTE

Repeat steps 7 and 8 until the desired receive frequency has been set.

9. STO Switch -- DEPRESS to store the emission mode and receive frequency in memory. Note flashing TX annunciation indicating system readiness to accept a transmit frequency.

NOTE

For **Semi-Duplex** channel programming, continue with step 10. For **Simplex** channel programming, continue starting with step 12. For **Receive-Only** channel programming, continue starting with step 13.

10. Outer Concentric Knob -- ROTATE to position cursor over transmit frequency digit to be changed.
11. Inner Concentric Knob -- ROTATE to set desired number under cursor.

NOTE

Repeat steps 10 and 11 until the desired transmit frequency has been set.

12. STO Switch -- DEPRESS to store the transmit frequency in memory.
13. Outer Concentric Knob -- ROTATE to stow cursor if not already stowed. (The cursor is automatically stowed when the transmit frequency is stored in memory).
14. Inner Concentric Knob -- ROTATE to select the next desired channel number for programming. There are 99 channels available.

NOTE

Return to step 6 to continue channel programming.

15. PGM Switch -- DEPRESS to exit the program mode when programming is completed. Note PGM annunciation extinguishes.

NORMAL OPERATION:**WARNING**

WHEN PERFORMING A KHF-950 RADIO CHECK ON THE GROUND, MAKE CERTAIN THAT ALL PERSONNEL ARE CLEAR OF THE HF ANTENNA BEFORE TRANSMITTING. SERIOUS RF BURNS CAN RESULT FROM DIRECT CONTACT WITH THE ANTENNA OR ANTENNA TERMINAL WHEN THE SYSTEM IS TRANSMITTING.

1. Preflight -- COMPLETE.
2. MIC (Microphone) Selector Switch (on audio control panel) -- SELECT HF position.
3. HF SPEAKER/PHONE Selector Buttons (on audio control panel) -- PRESS desired mode.
4. OFF/VOLUME Control Knob -- TURN ON.
5. FREQ/CHAN Button -- SELECT direct tuning operation (FREQ/CHAN button "out" - simplex-only) or programmed channel operation (FREQ/CHAN button "in").

DIRECT TUNING:

- a. Outer Concentric Knob -- ROTATE to position cursor over simplex frequency digit to be changed.
- b. Inner Concentric Knob -- ROTATE to set desired number under the cursor.

NOTE

Repeat steps a. and b. until the desired frequency has been set.

- c. MODE Button -- PRESS as required. Repeat until desired emission mode is annunciated.

CHANNEL OPERATION:

- a. Outer Concentric Knob -- ROTATE to stow cursor if not already stowed.
 - b. Inner Concentric Knob -- ROTATE to select desired channel number.
6. MIC Button (on control wheel) -- PRESS to initiate antenna tuning sequence. Note flashing TX and the blanking of the frequency display.

7. OFF/VOLUME Knob -- SET to desired volume level.
8. SQUELCH Knob -- SET to desired level usually full clockwise.
9. CLARIFIER Knob -- PULL out knob and ROTATE in either direction to optimize incoming SSB signal quality.

OPERATIONAL NOTES:

HF SSB COMMUNICATIONS:

1. Most all airplane HF SSB communications are conducted in USB mode. Some ground stations continue to use the AM mode, but these stations are being phased out in favor of the more efficient SSB mode of operation.

SEMI-DUPLEX OPERATION:

1. In semi-duplex operation, the emission mode you select (USB or AM) will always control both receive and transmit frequencies. Also, the receive frequency is displayed until the mike is keyed, at which time the transmit frequency is displayed.

SELECTING FREQUENCIES:

1. The higher frequencies are best during daylight (10,000.0 to 29,999.9 kHz) and the lower frequencies work best at night (2000.0 to 10,000.0 kHz).

RETUNING THE ANTENNA COUPLER:

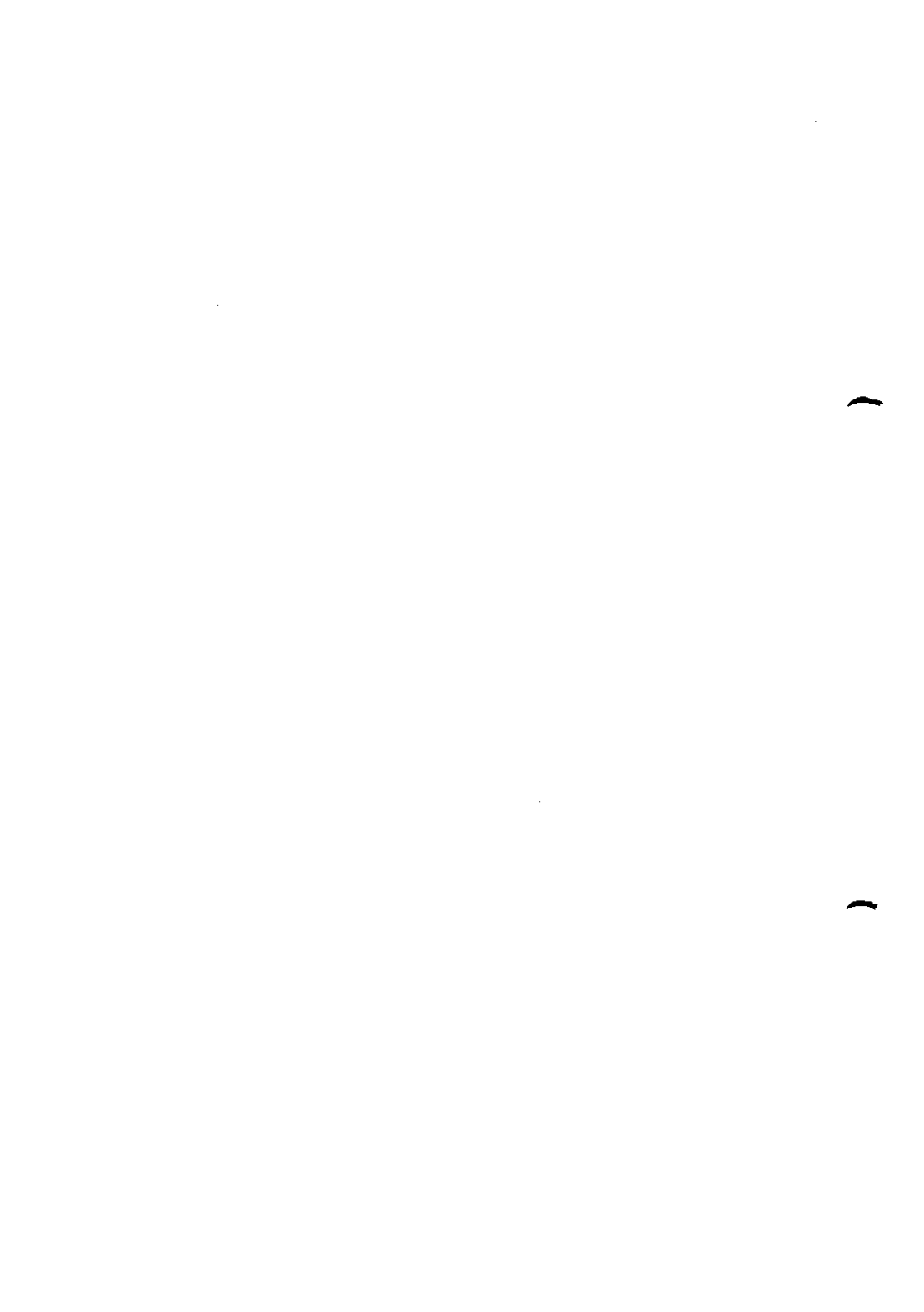
1. It is necessary to retune the antenna coupler whenever the MODE selector knob is changed from one mode to another. Pressing the MIC button momentarily initiates antenna tuning.

ADDITIONAL INFORMATION:

1. For expanded information and operational instructions, refer to the "King KHF-950 Pilot's Guide and Directory of HF Services" supplied with your airplane.

**SECTION 5
PERFORMANCE**

There is no change to the airplane performance when this avionic equipment is installed. However, the installation of an externally-mounted antenna or several related external antennas will result in a minor reduction in cruise performance.



SUPPLEMENT KING MARKER BEACON

(Type KR-21)

SECTION 1

GENERAL

The King Type KR-21 Marker Beacon System consists of a panel mounted 75 MHz marker beacon receiver, a KMA-24H-70 Audio Control Panel for speaker/phone audio selection and externally mounted marker beacon antenna mounted on the under side of the airplane.

The front panel of the KR-21 Marker Beacon Receiver incorporates a three position toggle switch that provides for selection of HI or LO marker beacon signal sensitivity and a marker beacon lamp test. Three lights are installed on the front of the panel with different colored lenses to indicate passage over the markers. The white light (Inner and Fan) has an A engraved on its lens, the blue light (Outer) has an O engraved on its lens and the amber light (Middle) has a M engraved on its lens. The receiver's front panel also incorporates a photo-cell light sensor which provides automatic dimming circuits for the marker lamps to compensate for ambient cockpit lighting.

The KMA-24H-70 Audio Control Panel provides marker beacon SPEAKER and PHONE selector pushbuttons to let the operator receive marker beacon audio signals over the cockpit speaker or headphones as desired. Refer to Supplement 26 in this manual for complete audio control panel operations.

The HI sensitivity selector switch position, labeled H, is used for airway operation.

The LO sensitivity selector switch position, labeled L, is used for ILS approaches.

The marker beacon lights test position, labeled T, is selected to verify operation of the marker beacon lights.

All operating controls for the KR-21 Marker Beacon Receiver and marker beacon operating controls on the Audio Control Panel are shown and described in Figure 1.

MARKER FACILITIES

| MARKER | IDENTIFYING TONE | LIGHT * |
|-------------|---|---------|
| Inner & Fan | Continuous 6 dots/sec (3000 Hz) | White |
| Back Course | 72-95 two dot combinations per second (3000 Hz) | White |
| Middle | Alternate dots and dashes (1300 Hz) | Amber |
| Outer | 2 dashes/sec (400 Hz) | Blue |

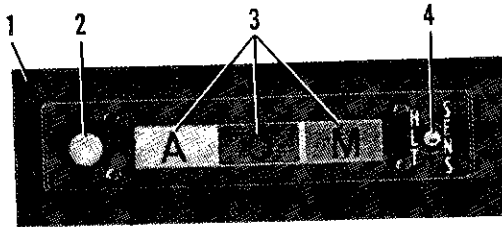
* When the identifying tone is keyed, the respective indicating light will blink accordingly.

SECTION 2 LIMITATIONS

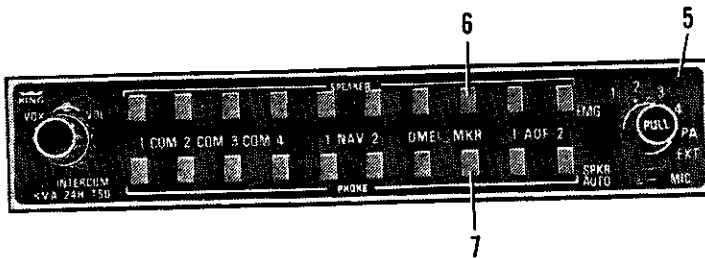
There is no change to the airplane limitations when this avionics equipment is installed.

SECTION 3 EMERGENCY PROCEDURES

There is no change to the airplane emergency procedures when this avionics equipment is installed.



KR-21 Marker Beacon Receiver Panel



KMA-24H-70 Audio Control Panel

1. KING TYPE KR-21 MARKER BEACON RECEIVER PANEL.
2. PHOTO-CELL LIGHT SENSOR - Provides automatic dimming for the marker lamps to compensate for ambient cockpit lighting.
3. MARKER BEACON ANNUNCIATOR LIGHTS:
 AIRWAY, INNER and FAN (A) - Light illuminates white to indicate passage of airway, ILS inner, fan and back course marker beacons.
 OUTER (O) - Light illuminates amber to indicate passage of outer marker beacon.
 MIDDLE (M) - Light illuminates amber to indicate passage of middle marker beacon.
4. THREE POSITION TOGGLE SWITCH FOR MARKER BEACON SENSITIVITY SELECTION AND MARKER BEACON LIGHTS TEST:
 H Position - When placed in the H position (Up), HI SENSE is selected which increases receiver sensitivity for airway flying.
 L Position - When placed in the L position (Middle), LO SENSE is selected for ILS approaches.
 T Position - When placed in the T position (Bottom), automatically illuminates the marker beacon lights to verify test.

Figure 1. King Marker Beacon (Type KR-21) Operating Controls and Indicators (Sheet 1 of 2)

5. KING KMA-24H-70 AUDIO CONTROL PANEL REQUIRED WITH KING KR-21 MARKER BEACON INSTALLATION.
6. MARKER BEACON SPEAKER AUDIO MONITOR PUSHBUTTON - When depressed, the marker beacon audio signals can be heard over the cabin-top speaker. To disconnect the marker beacon audio from the cabin-top speaker, depress the pushbutton a second time.
7. MARKER BEACON PHONE AUDIO MONITOR PUSHBUTTON - When depressed, the marker beacon audio signals can be heard over the headphones. To disconnect the marker beacon audio from the headphones, depress the pushbutton a second time.

Figure 1. King Marker Beacon (Type KR-21) Operating Controls and Indicators (Sheet 2 of 2)

SECTION 4

NORMAL PROCEDURES

MARKER BEACON OPERATING PROCEDURES:

NOTE

The marker beacon receiver is capable of receiving marker beacon signals anytime the No. 1 AVIONICS switch is ON.

1. Nav Receiver Volume Control -- ADJUST to desired listening level.
2. HI/LO Sensitivity Selector Switch -- SELECT H (HI) position for airway flying or L (LO) position for ILS approaches.
3. MKR SPEAKER/PHONE Pushbuttons (On Audio Control Panel) -- SELECT desired speaker or headphone audio.
4. Test (T) Selector Switch -- SELECT T position and verify that all marker beacon annunciator lights will illuminate full bright to indicate lights are operational.

SECTION 5

PERFORMANCE

There is no change to the airplane performance when this avionics equipment is installed. However, the installation of an externally mounted antenna or several related external antennas, will result in minor reduction in cruise performance.

SUPPLEMENT KING RADAR ALTIMETER (Type KRA-10A)

SECTION 1 GENERAL

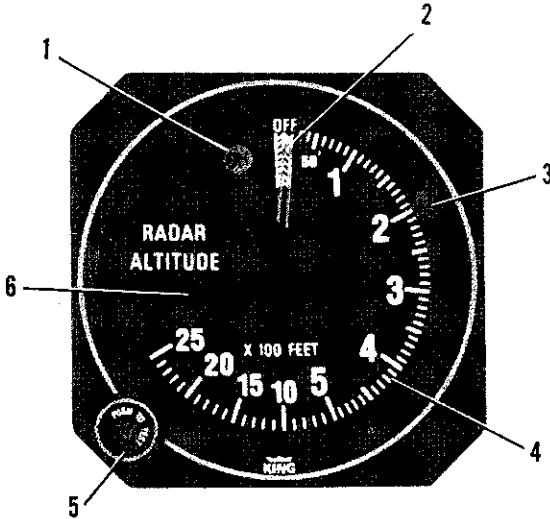
The King Radar Altimeter (Type KRA-10A), shown in Figure 1, consists of a panel-mounted indicator, a remote mounted receiver/transmitter and an antenna.

The Radar Altimeter (depending upon terrain reflectivity and airplane bank angle) gives an absolute altitude indication from 2500 feet AGL to 35 ± 15 feet AGL. It provides continuous selection of warning altitude and annunciation of descent to that altitude by both a DH (decision height) light and an aural warning. Climbing through the selected warning altitude extinguishes the DH light. The DH light is automatically dimmed by a photo cell. Indicator lighting is controlled by the radio light dimming rheostat.

The Radar Altimeter remote receiver/transmitter is all solid-state and operates on 28-volt primary power. Complete self-test may be accomplished both on preflight and in-flight.

SECTION 2 LIMITATIONS

There is no change to the airplane limitation when this avionic equipment is installed.



1. DECISION HEIGHT LIGHT (DH) - Alerts that the absolute altitude of the airplane is at or below the selected decision height.
2. POINTER - Indicates the airplane's absolute altitude.
3. DH BUG - Indicates the selected alert altitude which when reached will trigger an aural and visual warning.
4. ALTITUDE SCALE - Indicates height above ground level in feet from 2500 to 20.
5. DH SELECT/TEST KNOB (PUSH-TO-TEST Δ) - Rotates to select the position of the DH Bug and presses to test the altimeter for proper operation.
6. MASK - Hides pointer when above 2500 feet AGL or the receiver experiences loss of signal.

Figure 1. King Radar Altimeter (Type KRA-10A)

SECTION 3 EMERGENCY PROCEDURES

There is no change to the airplane emergency procedures when this avionic equipment is installed.

SECTION 4 NORMAL PROCEDURES

PREFLIGHT AND IN-FLIGHT SELF-TEST:

1. AVIONICS MASTER Switch -- ON.
2. DH Bug -- SET to 20 feet.
3. DH Select/Test Knob -- DEPRESS and HOLD. The indicated altitude should be 50 ± 5 feet and the DH lamp should be off.
4. DH Select/Test Knob -- DEPRESS and TURN slowly clockwise. The DH lamp should light and a two-second audio tone will sound when the DH bug reaches 50 ± 5 feet.
5. DH Select/Test Knob -- RELEASE. The DH lamp will go out and the pointer will move clockwise behind the mask. When flying at an altitude below 2500 feet AGL, pointer will remain in view.

NOTE

Ground operation near large hangars, other airplane, water puddles and other nearby objects may cause the pointer to come into view. This does not indicate a system malfunction since the reflections constitute a real signal.

NORMAL OPERATION:

1. AVIONICS MASTER Switch -- ON.
2. DH Bug -- SET as desired.

CAUTION

The radar altimeter must not be used to identify the MDA (Minimum Descent Altitude) or DH (Decision Height) while making an instrument approach.

OPERATIONAL NOTES:

1. During take-off, radar altimeter indications are unreliable until after approximately the first 15 seconds after climbing above 50 feet altitude.
2. Depending upon terrain reflectivity, initial and/or reliable indications during descents through the 2500-foot level may not occur until the airplane has reached absolute altitudes as low as 1500 feet.
3. Accuracy in level flight or in descents at rates up to 1000 FPM is within 7% or 80 feet, whichever is greater.
4. The pointer will disappear from view below 2500 feet if the ground return signal is lost. The pointer may also disappear from view momentarily when the airplane is in a bank in excess of 15° (above 2000 feet) or (45° below 1000 feet).
5. Once the indicator has reached 35 ± 15 feet during landing approach, further indications in this range are unreliable, since the indicator may dwell briefly in this range even as the airplane descends further.
6. The pointer will move to the OFF position if primary power is lost.

**SECTION 5
PERFORMANCE**

There is no change to the airplane performance when this avionic equipment is installed. However, the installation of an externally mounted antenna or several related external antennas, will result in minor reduction in cruise performance.

SUPPLEMENT KING RADIO MAGNETIC INDICATOR

(Type KI-229)

SECTION 1

GENERAL

The King Radio Magnetic Indicator (RMI) is used in conjunction with other airborne navigation equipment to aid the pilot in navigating the airplane. The RMI eliminates the need for many of the mental computations necessary for determining the airplane position.

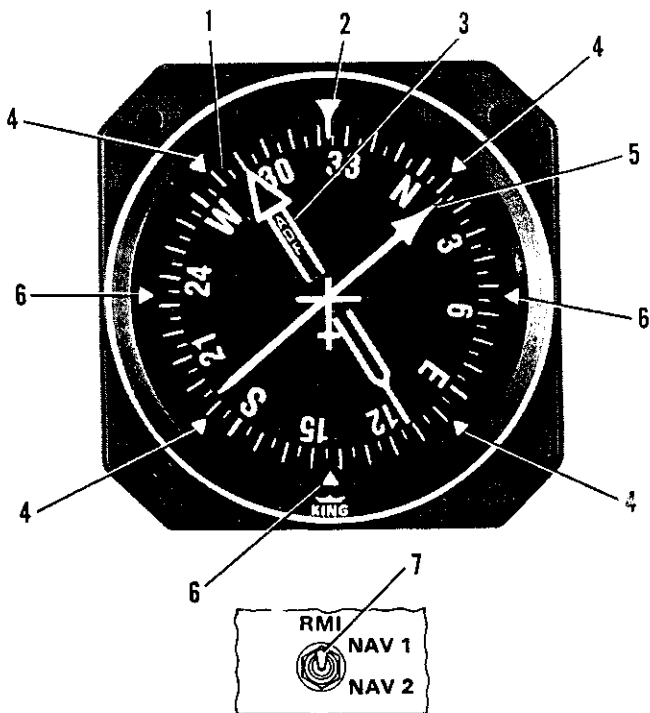
The RMI is a panel mounted navigation instrument that combines the display of VOR and ADF bearing information with the airplane heading on a single instrument. The VOR and ADF magnetic bearings to the selected stations are displayed by individual rotating pointers against the background of a rotating azimuth card. The azimuth card is driven by the slaved magnetic compass system in the airplane and continuously indicates airplane heading. Thus, the relative bearing between the airplane heading and the station is pictorially displayed.

Each pointer in the Type KI-229 RMI is dependent on its associated receiver for indicating bearings. A single-bar pointer indicates VOR bearings and a double-bar pointer indicates ADF bearings. Two NAV receivers supply VOR signals to the RMI for selection. When one of the VOR receivers is a KNS-81 Area Navigation System, the single-bar pointer can indicate the RNAV waypoint bearing. A two-position selector switch (NAV 1/NAV 2) on the instrument panel selects the desired VOR signal for display of bearing information. The KI-229 RMI is internally lighted. Intensity is controlled by the RADIO light dimming rheostat.

SECTION 2

LIMITATIONS

There is no change to the airplane limitations when this avionic equipment is installed.



1. ROTATING AZIMUTH (COMPASS) CARD - Rotates as the airplane turns so that the airplane magnetic heading is continuously displayed at the heading index.
2. HEADING INDEX - Indicates the airplane magnetic heading on the azimuth card.
3. DOUBLE-BAR POINTER - Indicates the magnetic bearing to the station to which the ADF is tuned.
4. INDICES - Four reference marks spaced 45 degrees between the Heading Index and Cardinal Points.
5. SINGLE-BAR POINTER - Indicates the magnetic bearing to the selected VOR station.
6. CARDINAL POINT - One of the four main points on a compass. Cardinal points are spaced 90 degrees apart.
7. NAV 1/NAV 2 FUNCTION SWITCH - Selects either NAV 1 or NAV 2 VOR signal for display by the single-bar pointer.

Figure 1. King Radio Magnetic Indicator (Type KI-229)

SECTION 3 EMERGENCY PROCEDURES

There is no change to the airplane emergency procedures when this avionic equipment is installed.

SECTION 4 NORMAL PROCEDURES

NORMAL OPERATION:

NOTE

Operation of the RMI is dependent upon input information from the compass system (slaved directional gyro or HSI), the associated VHF navigation and ADF receivers. Refer to the appropriate supplements in this section for operation of this equipment.

1. Compass Cards (on RMI and HSI) -- CHECK that heading indications on RMI and HSI are the same.
2. ADF Receiver -- SELECT STATION on receiver. The double-bar pointer will indicate the magnetic bearing to the station.

NOTE

If the ADF receiver is turned OFF, the double-bar pointer will remain fixed in its last position.

3. NAV 1-2 Selector Switch (for RMI) -- SET to NAV 1 or NAV 2 and select VOR station on the associated NAV receiver. The single-bar pointer will indicate the magnetic bearing to the station.

NOTE

This reading is equivalent to the "TO" course reading obtained with the standard CDI omni bearing selector. The "FROM" radial of the VOR station is obtained by reading the opposite end of the pointer.

WARNING

- If the RMI Compass Card is not tracking the Directional Gyro or HSI, the VOR bearings are invalid. This may be caused by a failure in the RMI, Slaved Compass System, or a loss of power from the AC Inverter.
- The ADF indications are valid relative to the nose of the airplane only and may be used by referring to the Heading Index and 45 degree indices on the RMI.

RMI TEST:

1. ADF Receiver -- TUNE to usable frequency with ADF mode selected.
2. ADF Button (On KR-87 Receiver) -- SELECT ANT mode. Double-bar pointer will slew to the three o'clock position.
3. ADF -- SELECT ADF mode and OBSERVE that double-bar pointer (on RMI) returns to the same station bearing as in step 1 to indicate a normal operation.

NOTE

If the ADF Receiver is turned OFF, the double-bar pointer will remain fixed in its last position.

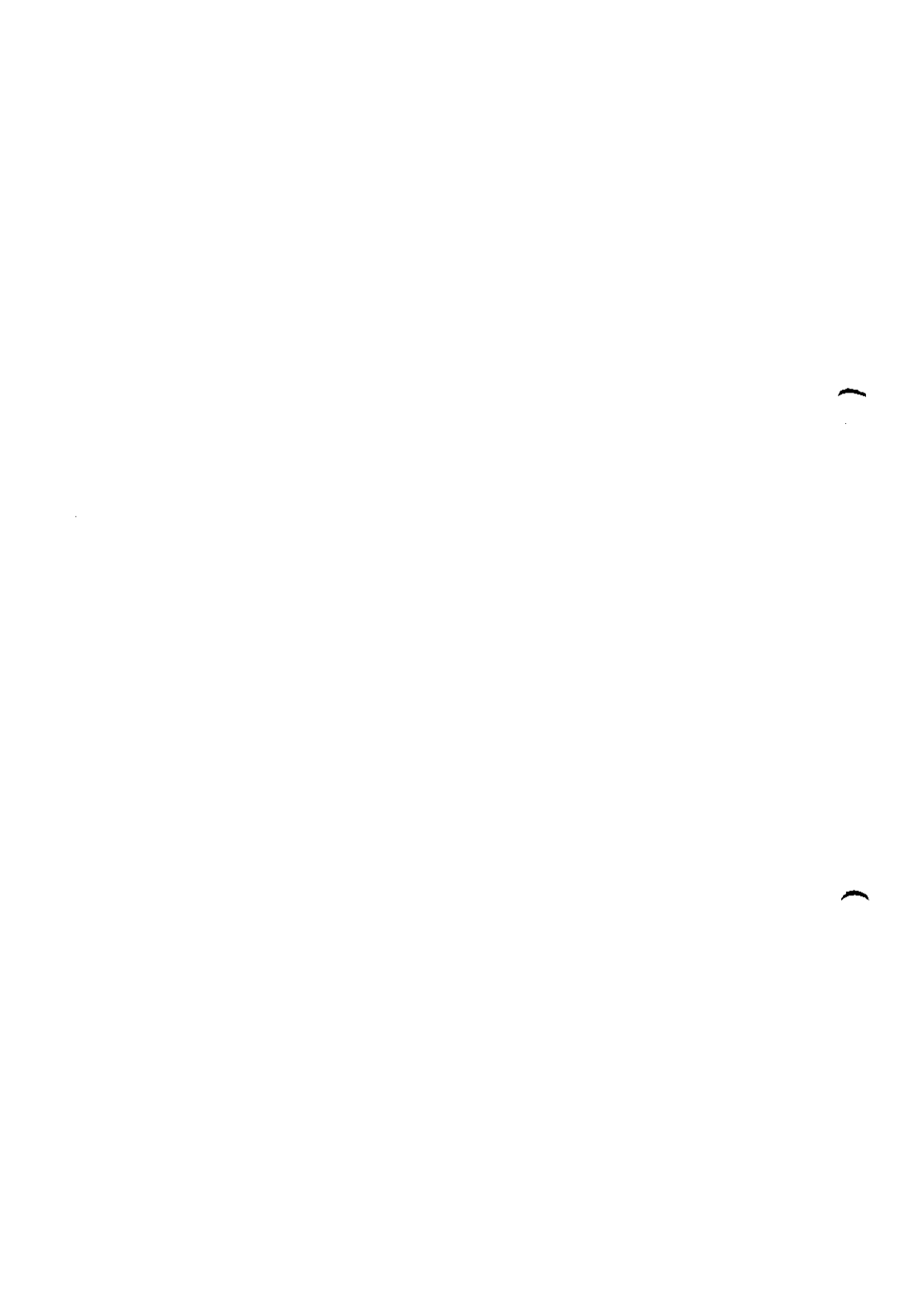
4. VOR Receiver -- TUNE to usable VOR frequency.
5. VOR Receiver -- TURN OFF. Single-bar pointer will slew to the three o'clock position.
6. VOR Receiver -- TURN ON and OBSERVE that the single-bar pointer (on RMI) returns to the same station bearing as in step 4 to indicate a normal operation.

NOTE

If the selected VOR Receiver is turned off or a reliable signal is not being received, or an ILS frequency is selected, the single-bar pointer will move to the stowed position (fixed at the 3 o'clock position).

**SECTION 5
PERFORMANCE**

There is no change to the airplane performance when this avionic equipment is installed in addition to that which occurs with installation of the ADF or VOR antennas.



SUPPLEMENT KING RADIO MAGNETIC INDICATOR

(Type KNI-582)

SECTION 1

GENERAL

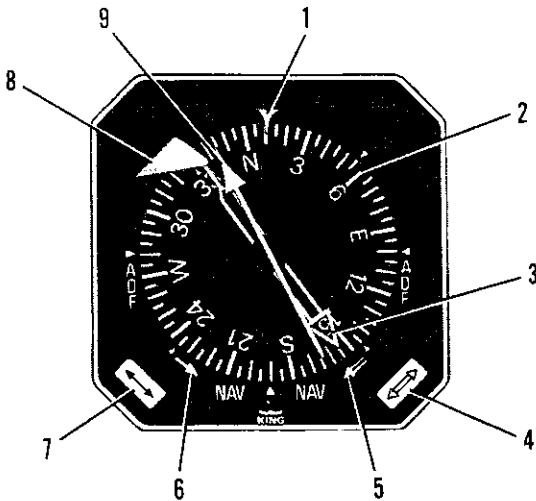
The King KNI-582 Radio Magnetic Indicator (RMI) is used in conjunction with other airborne navigation equipment to aid the pilot in navigating the airplane. The RMI eliminates the need for many of the numerical and graphical computations necessary for determining the airplane position.

The RMI is a panel mounted navigation instrument that combines the display of NAV and ADF bearing information with the airplane heading on a single instrument. The NAV and ADF magnetic bearings to the selected stations are displayed by individual rotating pointers against the background of a rotating azimuth card. The azimuth card is driven by the slaved magnetic compass system in the airplane and continuously indicates airplane heading. Thus, the relative bearing between the airplane heading and the station is pictorially displayed.

Each pointer in the KNI-582 RMI is dependent only on its associated receiver for indicating bearings. A single-bar pointer indicates NAV 1 or ADF bearings and a double-bar pointer indicates NAV 2 or ADF bearings. The choice of NAV or ADF information displayed by each pointer is determined by the corresponding front panel display switch.

Should a localizer frequency be selected or the NAV receiver indicate a flagged condition, the NAV pointer will slew to the 3 o'clock position.

A HDG flag falls into view in the upper left corner of the display when the heading information being displayed is invalid.



1. HEADING INDEX - Indicates the airplane magnetic heading on the azimuth card.
2. ROTATING AZIMUTH (COMPASS) CARD - Rotates as the airplane turns so that the airplane magnetic heading is continuously displayed at the heading index.
3. DOUBLE-BAR POINTER - Indicates the magnetic bearing to NAV 2 or the ADF station. Will slew to the 3 o'clock position if in NAV mode and a localizer frequency is selected, or the NAV receiver flags.
4. DOUBLE-BAR POINTER DISPLAY SWITCH - Dual position pushbutton switch used to select either NAV 2 or ADF mode.
5. DOUBLE-BAR POINTER MODE INDICATOR - Indicates either NAV 1 or ADF mode.
6. SINGLE-BAR POINTER MODE INDICATOR - Indicates either NAV 1 or ADF mode.
7. SINGLE-BAR POINTER DISPLAY SWITCH - Dual position pushbutton switch used to select either NAV 1 or ADF mode.
8. COMPASS (HDG) FLAG - Comes into view whenever heading information is invalid.
9. SINGLE-BAR POINTER - Indicates the magnetic bearing to NAV 1 or the ADF station. Will slew to the 3 o'clock position if in nav mode and a localizer frequency is selected, or the NAV receiver flags.

Figure 1. King RMI (Type KNI-582) Operating Controls and Indicators

SECTION 2 LIMITATIONS

There is no change to the airplane limitations when this avionic equipment is installed.

SECTION 3 EMERGENCY PROCEDURES

There is no change to the airplane emergency procedures when this avionic equipment is installed.

SECTION 4 NORMAL PROCEDURES

NORMAL OPERATION:

NOTE

Operation of the RMI is dependent upon input information from the compass system (slaved directional gyro), the associated VHF navigation and ADF receivers. Refer to the appropriate supplements in this section for operation of this equipment.

1. Compass Cards (on RMI and HSI) -- CHECK that heading indications on RMI and HSI are the same.
2. ADF Receiver -- TUNE to usable frequency with ADF mode selected.
3. Single- or Double Bar-Pointer Display Switch -- SELECT ADF mode.
4. READ magnetic bearing to the ADF station under the selected pointer.

NOTE

If the ADF receiver is turned off, the selected pointer will remain fixed in its last position.

5. NAV Receiver -- TUNE to usable VOR frequency.
6. Single or Double-Bar Pointer Display Switch -- SELECT NAV mode. Choose double-bar pointer if NAV 2 is desired or single-bar pointer for NAV 1.
7. READ indicated magnetic bearing to the VOR station under the selected pointer.

NOTE

- If the NAV receiver is turned off or a localizer frequency is selected, the pointer will slew to the 3 o'clock position.
- This reading is equivalent to the "TO" course reading obtained with the standard CDI omni bearing selector. The radial of the VOR station is obtained by reading the opposite end of the pointer.

WARNING

- **If the RMI Compass Card is not tracking the Directional Gyro or HSI, the VOR bearings are invalid. This may be caused by a failure in the RMI, Slaved Compass System, or a loss of power from the AC Inverter.**
- **The ADF indications are valid relative to the nose of the airplane only and may be used by referring to the Heading Index and 45 degree indices on the RMI.**

RMI TEST:

1. ADF Receiver -- TUNE to usable frequency with ADF mode selected.
2. Single- or Double-Bar Pointer Display Switch -- SELECT ADF mode.
3. ADF Button (On KR-87 Receiver) -- SELECT ANT mode. Selected RMI pointer will slew to the 3 o'clock position.
4. ADF Button (On KR-87 Receiver) -- SELECT ADF mode and OBSERVE that selected RMI pointer returns to the same station bearing as in step 2 to indicate normal operation.

NOTE

If the ADF receiver is turned off, the selected pointer will remain fixed in its last position.

5. NAV Receiver (NAV 1 or NAV 2) -- TUNE to usable VOR frequency.

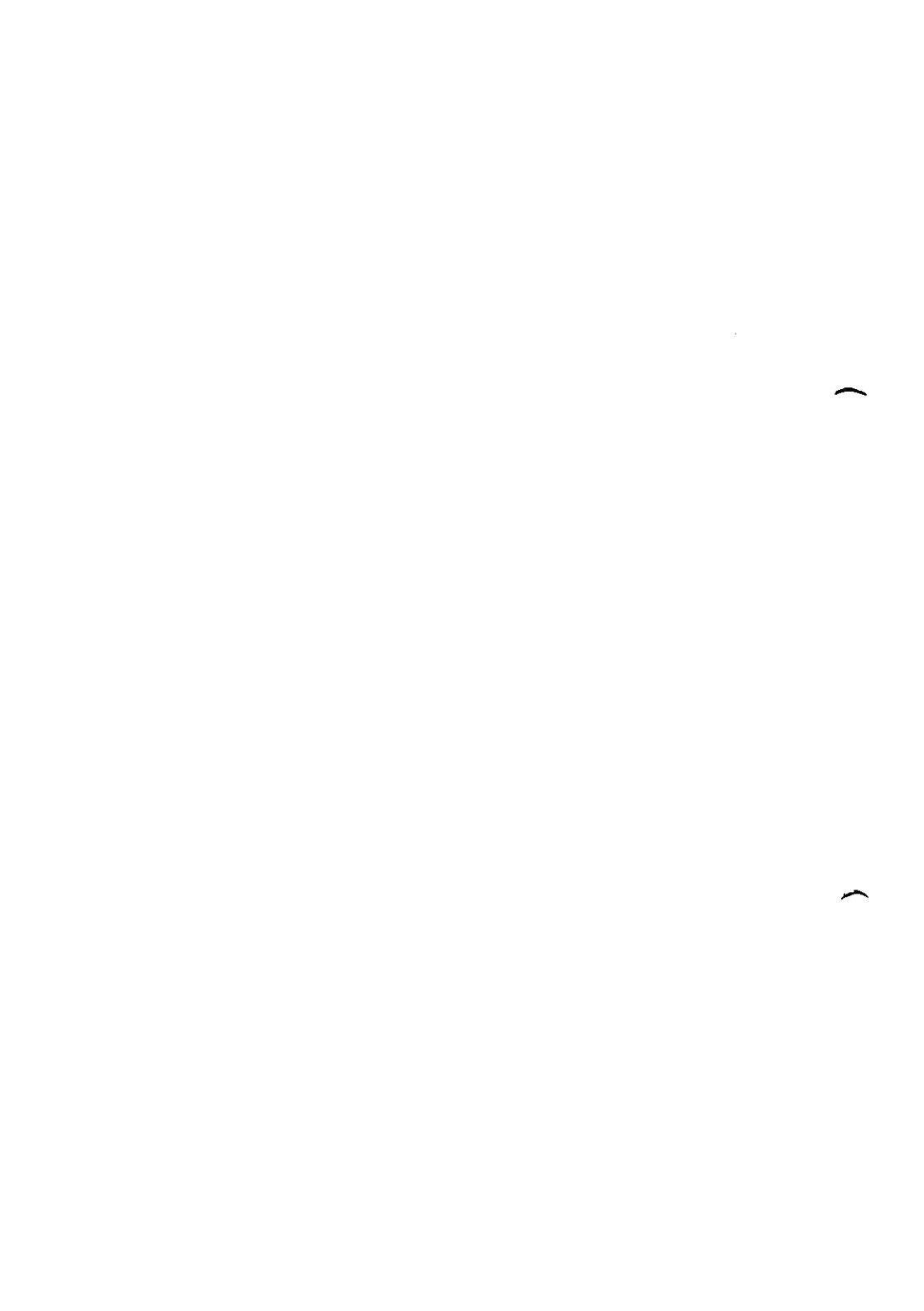
6. Single- or Double-Bar Pointer Display Switch (as appropriate to the selected NAV) -- SELECT NAV mode.
7. NAV Receiver -- TURN OFF. Appropriate RMI pointer will slew to the 3 o'clock position.
8. NAV Receiver -- TURN ON and observe that the appropriate RMI pointer returns to the same station bearing as in step 6 to indicate normal operation.

NOTE

If the selected NAV receiver is turned off or a reliable signal is not being received, or an ILS frequency is selected, the appropriate pointer will stow at the 3 o'clock position.

**SECTION 5
PERFORMANCE**

There is no change to the airplane performance data when this avionics equipment is installed.



SUPPLEMENT KING TRANSPONDER

(Type KT-79)

SECTION 1

GENERAL

The King Transponder (Type KT-79), shown in Figure 1, is the airborne component of an Air Traffic Control Radar Beacon System (ATCRBS). The transponder enables the ATC ground controller to see and identify more readily the aircraft on the radarscope. The encoding altimeter (described in Supplement 11 in Section 9 of this handbook) enables the transponder to automatically report aircraft altitude to ATC.

The King Transponder system consists of a panel-mounted unit, an externally-mounted antenna, and an optional control wheel-mounted XPDR IDENT switch. The transponder receives interrogating pulse signals on 1030 MHz and transmits coded pulse-train reply signals on 1090 MHz. It is capable of replying to Mode A (aircraft identification) and also to Mode C (altitude reporting) interrogations on a selective reply basis on any of 4096 information code selections. When the KT-79 is connected to an optional panel mounted Encoding Altimeter (not part of KT-79 Transponder System) is included in the avionic configuration, the transponder can provide altitude reporting in 100-foot increments between -1000 and +35,000 feet.

The KT-79 features an all solid-state transmitter with microprocessor control and LSI (Large Scale Integrated) encoding circuitry. Mode and code selection are performed by two concentric knobs, and all functions including the flight level altitude are presented on a gas discharge display. All display segments are automatically dimmed by a photocell type sensor.

A VFR programming sequence allows the pilot to preprogram any single four-digit code into the KT-79. Pressing the VFR button instantly returns the KT-79 to the preprogrammed code without having to turn any other knobs.

All King Transponder operating controls, with the exception of the operational altitude encoding altimeter setting knob and the optional remote XPDR IDENT switch, are located on the front panel of the unit. The altimeter setting knob is located on the encoding altimeter (not shown) and the remote XPDR IDENT switch is located on the right-hand grip of the pilot's and left-hand grip of the copilot's control wheel. Functions of the operating controls are described in Figure 1.

SECTION 2 LIMITATIONS

There is no change to the airplane limitations when this avionic equipment is installed.

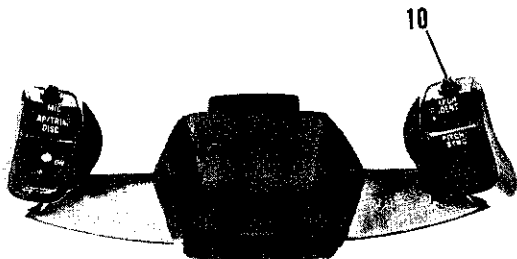
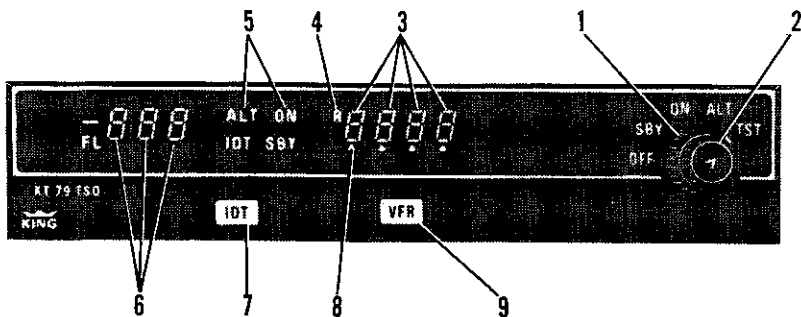
SECTION 3 EMERGENCY PROCEDURES

TO TRANSMIT AN EMERGENCY SIGNAL:

1. Mode Selector Knob -- ON (or ALT).
2. Code Selector Knob -- SELECT 7700 operating code.

TO TRANSMIT A SIGNAL REPRESENTING LOSS OF ALL COMMUNICATIONS (WHEN IN A CONTROLLED ENVIRONMENT):

1. Mode Selector Knob -- ON (or ALT).
2. Code Selector Knob -- SELECT 7700 operating code for 1 minute; then SELECT 7600 operating code for 15 minutes and then REPEAT this procedure at the same intervals for remainder of flight.



PILOT'S CONTROL WHEEL SHOWN

1. MODE SELECTOR KNOB - Outer concentric knob controls application of power and selects transponder operating mode as follows:
 - OFF - Turns set off.
 - SBY - Turns set on for standby power and code selection. "SBY" is annunciated.
 - ON - Turns set on and enables transponder to transmit Mode A (aircraft identification) reply pulses. ON is annunciated.
 - ALT - Turns set on and enables transponder to transmit either Mode A (aircraft identification) reply pulses or Mode C (altitude reporting) pulses selected automatically by the interrogating signal. ALT ON is annunciated.
 - TST - Self-test function, when selected, causes transponder to respond to internal interrogation, providing a check of receiver operation. The transmitter is disabled. All display segments will illuminate. Failure of the reply indicator "R" to illuminate indicates that a receiver fault has been detected.

Figure 1. King Transponder Operating Controls (Sheet 1 of 2)

2. CODE SELECTOR KNOB - Inner concentric knob select assigned Mode A reply code. The new code will be transmitted after a 5-second delay.
3. CODE DISPLAY - Displays selected Mode A reply code. Code is also written into nonvolatile memory so that the code will not change due to power interruption.
4. REPLY INDICATOR (R) - "R" flashes to indicate transmission of reply pulses; glows steadily to indicate satisfactory self-test operation.
5. MODE ANNUNCIATORS - Display the operating mode of the transponder.
6. ALTITUDE DISPLAY - Displays FL and flight level altitude (pressure altitude) in hundreds of feet when used in conjunction with an encoding altimeter and ALT mode is selected. Should an invalid code be detected from the altimeter, dashes will appear in the display window and altitude reporting will be disabled.
7. IDENT BUTTON (IDT) - When depressed, selects special identifier pulse to be transmitted with transponder reply to effect immediate identification of the airplane on the ground controller's display. (IDT will glow steadily during duration of IDENT pulse transmission.) Pressing the Ident Button will terminate a normal 5-second delay associated with the selection of a new Mode A reply code. Button illumination is controlled by the radio light dimming rheostat.
8. DIGIT SELECT POINTER - Indicates which digit may be changed by rotation of the Code Selector Knob. The pointer may be sequenced left to right and then back again by momentarily depressing the Code Selector Knob.
9. VFR CODE BUTTON (VFR) - Pressing the VFR Button will cause a preprogrammed Mode A reply code to supersede whatever Mode A reply code was previously in use. Button illumination is controlled by the radio light dimming rheostat.
10. REMOTE ID SWITCH (XPDR IDENT) (Right hand grip on pilot's and left hand grip on copilot's control wheels) - When depressed, selects special identifier pulse to be transmitted with transponder reply to effect immediate identification of the airplane on the ground controller's display. (IDT will glow steadily during duration of IDENT pulse transmission.) Pressing the Ident Button will terminate a normal 5-second delay associated with the selection of a new Mode A reply code.

Figure 1. King Transponder Operating Controls (Sheet 2 of 2)

**SECTION 4
NORMAL PROCEDURES**

BEFORE TAKEOFF:

1. Mode Selector Knob -- SBY.

TO TRANSMIT MODE A (AIRCRAFT IDENTIFICATION) CODES IN FLIGHT:

1. Code Selector Knob -- SELECT assigned code.
2. Mode Selector Knob -- ON.

NOTE

- During normal operation with function selector switch in ON position, reply indicator flashes indicating transponder replies to interrogations.
 - Mode A reply codes are transmitted in ALT also; however, Mode C codes are suppressed when the Mode Selector Knob is positioned to ON.
3. IDT or XPDR Button -- DEPRESS momentarily when instructed by ground controller to "squawk IDENT" (IDT will glow steadily, indicating IDENT operation).

TO TRANSMIT MODE C (ALTITUDE REPORTING) CODES IN FLIGHT:

1. Encoder Altimeter Setting Knob -- SET IN local altimeter setting.
2. Transponder Code Selector Knob -- SELECT assigned code.
3. Mode Selector Knob -- ALT.

NOTE

When directed by ground controller to "stop altitude squawk", turn Mode Selector knob to ON for Mode A operation only.

**SECTION 5
PERFORMANCE**

There is no change to the airplane performance when this avionic equipment is installed. However, the installation of an externally-mounted antenna or several related external antennas, will result in a minor reduction in cruise performance.

SUPPLEMENT

NARCO WEATHER RADAR

(Type KWX-56 COLOR)

SECTION 1

GENERAL

The KWX-56 Color Weather Radar system consists of a nose-mounted receiver-transmitter and stabilized X-band radar antenna, and a panel-mounted radar indicator. All operating controls are mounted on the front panel of the radar indicator and operating controls and functions are described in Figure 1.

The KWX-56 Color Weather Radar system is designed to detect significant enroute weather formations within a range of 160 nautical miles to preclude undesirable penetration of heavy weather and its usually associated turbulence. The indicator provides a three-color display, showing three separate levels of rainfall intensity in green, yellow, and red. Blue segmented range circles, green alphanumeric, a zero-degree azimuth line and 20° bearing marks are also provided. In addition to its primary purpose of weather mapping, a ground mapping mode permits displaying prominent topographical features such as lakes, bays, islands, shore lines and urban areas. Display colors are changed in the MAP mode as follows: green to blue, yellow stays the same, and red to magenta.

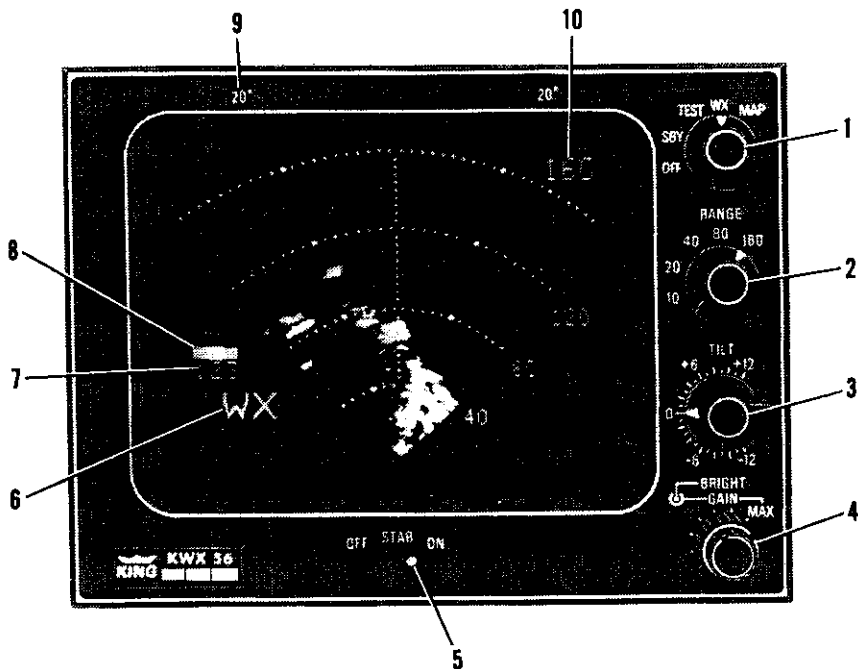
WARNING

This system generates microwave radiation in the WX and MAP operating modes. Improper use, or exposure, may cause serious bodily injury. DO NOT OPERATE UNTIL YOU HAVE READ AND CAREFULLY FOLLOWED ALL SAFETY PRECAUTIONS AND INSTRUCTIONS CALLED OUT IN SECTION 4 (NORMAL PROCEDURES) OF THIS SUPPLEMENT.

For expanded information and operational instructions, refer to the KWX-56 Pilot's Guide supplied with your airplane.

WARNING

Users of this equipment are strongly urged to familiarize themselves with FAA Advisory Circular AC No. 00-24B(1-20-83), subject: "Thunderstorms".



1. MODE SELECTOR KNOB - Used to turn the system on and select among four operational modes. The knob positions are as follows:

OFF - Turns radar off.

SBY (Standby) - The Standby mode is used for warmup (which requires about 60 seconds) and to maintain operational readiness of the KWX-56 system until the radar is needed. In the Standby mode the KWX-56 display is blanked and the antenna and transmitter are disabled. Only the magnetron heater is energized in SBY.

If an operational mode (other than SBY) is selected prior to warmup completion, the display will light up and "WARMUP" will be annunciated on the screen. The "WARMUP" annunciation will disappear after warmup completion, followed by proper operation in the selected mode.

TEST - In TEST, all circuitry is activated except the antenna and transmitter are disabled. A test pattern showing bands of all three WX mode colors is displayed on the screen. It is recommended that the brightness control (BRIGHT) be adjusted for optimum viewing when in the TEST mode.

Figure 1. Narco Weather Radar (X-Band Type KWX-56)
(Sheet 1 of 3)

WX (Weather) - In WX, the Weather mode, "WX" is annunciated on the screen and a color bar scale is displayed above it. The colors in the color bar, presented (from left to right) in the order of increasing target reflectivity, will be green for light precipitation, yellow for moderate, and red for heavy. Weather (or ground) targets will be displayed in those colors. The WX mode is the normal mode used for weather depiction.

MAP (Ground Mapping) - In MAP, the ground mapping mode, "MAP" is annunciated on the screen and a color bar scale is displayed above it. The colors in the color bar, presented in the order of increasing target reflectivity, will be blue, yellow, and magenta from left to right. The MAP mode is the normal mode used for ground mapping of major terrain features such as coast lines, lakes, rivers, cities, or mountains. The MAP mode does not differ technically from the WX mode and may be used to depict weather targets.

2. RANGE KNOB (RANGE) - Used to select one of five display ranges, 10, 20, 40, 80, and 160 nautical miles. Four range rings equally divide the maximum display range selected and each range ring is clearly marked with its distance value.
3. ANTENNA TILT CONTROL KNOB (TILT) - Used to adjust the antenna tilt up (+) or down (-) 12° relative to the horizon. Precise one-degree changes are possible through use of the control knob index marks.
4. BRIGHTNESS AND GAIN CONCENTRIC CONTROL KNOBS (BRIGHT/GAIN) - The inner brightness control knob (BRIGHT) adjusts the display brightness to accommodate existing cockpit ambient light conditions.

The outer gain control knob (GAIN) is normally left in the MAX detent, assuring that the automatic gain control circuits will assign the correct intensity level (color) to any weather targets. Additional information can be obtained about storm intensity by rotating the control knob out of the (MAX) detent to progressively lower gain settings. As the gain is reduced while observing numerous red echoes, the storm cells of greatest intensity will remain red while the others will paint yellow. This will allow the pilot to discern between relative storm intensities. This information can be useful in planning course deviations to allow adequate separation.

Reduced gain settings can also be an aid in ground mapping.

The displayed color bar scale intensity level identifier annunciation "1 2 3" is replaced with the annunciation "VAR" when the gain control is rotated out of the MAX detent to indicate that the presentation is no longer calibrated by the automatic gain circuits.

THE GAIN CONTROL (GAIN) SHOULD ALWAYS BE IN THE MAX DETENT EXCEPT WHEN BEING USED TO ANALYZE WEATHER OR GROUND MAPPING TARGETS.

Figure 1. Narco Weather Radar (X-Band Type KWX-56)
(Sheet 2 of 3)

5. STABILITY ON/OFF SWITCH (STAB) - Turns antenna stabilization ON or OFF. The automatic antenna stabilization system utilizes an output from the airplane's attitude gyro to maintain a horizontal antenna scan through normal airplane bank angles and pitch changes up to a combined angle of 30°(bank angle + pitch angle + adjusted antenna TILT angle = 30°maximum). Beyond the 30°combined maximum, the antenna will not maintain a level scan.

STAB OFF should temporarily be selected in straight and level flight after periods of possible gyro precession such as takeoff acceleration, long shallow banked turns, etc. Gyro precession will be evident in the radar display in the STAB ON mode by the presence of more ground clutter on one side of the display than on the other side. STAB ON should again be selected after gyro erection.

6. SELECTED MODE - WX will be replaced by MAP in the MAP mode. Neither SBY nor TEST are annunciated in their respective modes.
7. COLOR BAR SCALE INTENSITY LEVELS - "1 2 3" will be annunciated when the GAIN control is set in the MAX detent (the calibrated gain setting). "1 2 3" will be replaced by "VAR" at lower than MAX gain settings.
8. COLOR BAR SCALE Depicts the colors in use (green, yellow, and red in WX; blue, yellow, and magenta in MAP), the brightness of the display, and the order of increasing target reflectivity (i.e. levels of rainfall intensity, etc.) going from left to right.
9. BEARING MARKS - 20°bearing marks are provided to assist in determining the relative bearing of displayed returns.
10. RANGE MARKS - Presented adjacent to each of the four range rings to identify in nautical miles the distance away from the airplane.

Figure 1. Narco Weather Radar (X-Band Type KWX-56)
(Sheet 3 of 3)

SECTION 2 LIMITATIONS

There is no change to the airplane limitations when this avionic equipment is installed. However, the following radar limitations must be followed during airplane operation.

1. Do not operate radar during refueling or within 15 feet of ground personnel.
2. Do not operate radar above 25,000 feet flight altitude

SECTION 3 EMERGENCY PROCEDURES

There is no change to the airplane emergency procedures when this avionic equipment is installed.

SECTION 4 NORMAL PROCEDURES

WARNING

The radar system generates microwave radiation and improper use, or exposure, may cause serious bodily injury. DO NOT OPERATE THIS EQUIPMENT UNTIL YOU HAVE READ AND CAREFULLY FOLLOWED THE FOLLOWING SAFETY PRECAUTIONS AND INSTRUCTIONS:

SAFETY PRECAUTIONS AND INSTRUCTIONS TO BE FOLLOWED PRIOR TO RADAR OPERATION:

1. Do not turn on or operate radar within 15 feet of ground personnel.
2. Do not turn on or operate radar during refueling operations.
3. Transmitter output power is radiated in the WX and MAP modes.
4. In order to prevent bodily injury to ground personnel, do not taxi the airplane unless the KWX-56 radar system is in the "OFF," "TEST," or "SBY" mode. Once reaching an area clear ahead of other airplane, ground personnel or large metal buildings, the system may be turned to the TEST or WX mode in preparation for takeoff.

PRIOR TO FLIGHT:

1. Ensure Safety Precautions have been observed.
2. Mode Selector Knob -- SBY for approximately 60 seconds warm up.
3. Mode Selector Knob -- TEST. Verify uniform pattern of WX mode colors.
4. Brightness Knob (BRIGHT) -- ADJUST to suit.
5. GAIN Control -- MAX. Verify "1 2 3" annunciation under color bar.
6. STAB ON/OFF Switch -- AS DESIRED.
7. Mode Selector Knob -- WX.
8. RANGE Knob -- 10, 20, or 40 AS REQUIRED for weather in departure area.
9. TILT Knob -- +4° or as required to minimize ground clutter after takeoff.

NOTE

Within the bounds of the ground safety precautions, study the weather conditions with the radar prior to takeoff to eliminate confusion from false returns due to ground clutter shortly after takeoff.

10. Mode Selector Knob -- SBY position for taxi maneuvers.

NORMAL OPERATIONS:

WEATHER DETECTION:

1. Mode Selector Knob -- WX (allow 1 minute for warm-up if set was previously off).
2. BRIGHT Knob -- ADJUST to suit.
3. RANGE Knob -- AS REQUIRED for weather.
4. TILT Knob --

NOTE

Proper tilt adjustment is one of the most important factors in obtaining optimum value from a weather radar. Too high will pass the majority of the radar beam above the storm cell, particularly when the storm is at a great distance. Too low an antenna tilt will clutter the indicator with ground returns. Optimum tilt is obtained by adjusting the antenna to obtain a slight amount of ground clutter. The maximum distance at which ground clutter can be obtained will depend greatly on the terrain and airplane altitude.

NOTE

It is recommended that while enroute and not using alternate ranges that the 40 n.m. or 80 n.m. range be selected and the TILT control be adjusted such that the inner 1/3 of the screen is painting ground clutter. This park position provides reasonably early presentation of weather and terrain features.

5. STAB ON/CFF Switch -- ON.

NOTE

Should the attitude gyro supplying pitch and roll information to the Weather Radar fail, the display may become unusable because of erratic or unsuitable tilting of the antenna. If this should happen, the STAB ON/OFF switch should be turned off to disable the gyro inputs and allow normal use of the tilt control.

6. GAIN Control -- MAX. Verify "1 2 3" annunciation under color bar. Reduce out of MAX while observing numerous red echoes to detect storm areas of greatest intensity.

NOTE

- Do **NOT** plan your route of flight to enter the shadow area behind a significant weather return. Due to signal attenuation, the ability to define weather in the shadow area may be severely limited.
- The KWX-56 Pilot's Guide should be consulted for a more thorough description of operating procedures for the weather radar and information on the interpretation of weather and ground returns.

GROUND MAPPING:

NOTE

Ground mapping by tilting the antenna down can be performed under certain conditions, particularly during overwater flights where coast lines and islands are apparent. Ground mapping is a secondary feature of this radar which is only useful after the operator is very familiar with the equipment. More complete discussion of this feature is included in the KWX-56 Pilot's Guide.

1. Mode Selector Switch -- MAP.
2. BRIGHT Knob -- ADJUST to suit.
3. RANGE Knob -- SELECT desired range.
4. TILT Knob -- ADJUST for desired ground return display.
5. STAB ON/OFF Switch -- ON.
6. GAIN Control -- MAX or reduce to adjust the prominence of ground features.

OPERATIONAL NOTES:

FALSE RETURN DISPLAYS:

1. Some energy is radiated peripherally from the radar antenna which, under some atmospheric conditions, will create a false return on the radar screen when the display is set on the 10 or 20 mile ranges. The false return will usually be most prominently displayed at approximately 2 miles from the origin when flying at altitudes near 12,000 ft. However, under certain atmospheric conditions, the false return can still be observed at a distance from the origin approximately equivalent to the airplane's altitude. Care must be taken not to confuse this normal interference return with a weather return. This is best accomplished by using the longer distance displays (40 or more) for early detection of significant weather.
2. Ground radar stations or other airborne weather radars may occasionally cause interference with the presentation of the return. The effect of this interference is to create one or more radial bands of false signal or noise extending from the bottom center outward to the outer range scale. These effects are usually of short duration and are dependent on the airplane's position and range from the ground station, the signal strength, and other factors.

HIGH ALTITUDE OPERATION:

1. The KWX-56 Color Weather Radar system has been approved to a maximum altitude of 25,000 feet. If flying at altitudes above 25,000 feet, the radar should be turned off to protect electrical circuitry in both the indicator and the antenna/receiver/transmitter units.

**SECTION 5
PERFORMANCE**

There is no change to the airplane performance when this avionic equipment is installed.

—

—

SUPPLEMENT

KING DIGITAL NAVIGATION RECEIVER

(Type KN-53)

SECTION 1

GENERAL

The King KN-53 Digital Nav, shown in Figure 1, consists of a panel-mounted receiver, KI-206 VOR/LOC/Glideslope Indicator and remote-mounted KN-72 VOR/LOC converter.

The set includes a 200-channel VHF navigation receiver and a 40-channel glideslope receiver which may be operated simultaneously. The NAV system receives omni and localizer signals between 108.00 and 117.95 MHz in 50-kHz steps. The glideslope receiver is automatically tuned when a localizer frequency is selected. The circuits required to interpret the omni and localizer signals are also an integral part of the Nav receiver.

Large self-dimming gas discharge readouts display the communications operating frequencies. The KN-53's unique "flip-flop" pre-select feature enables you to store one frequency in the standby display while operating on another and then interchange them instantly with the touch of a button. Both the active (USE) and the standby frequencies are stored in a circuit component called EAROM (Electrically Alterable Read Only Memory) that provides nonvolatile storage of both frequencies so that when the radio is turned off and then back on, channel information is retained.

A DME receiver-transmitter may be interconnected for automatic selection of the associated DME frequency. When a VOR frequency is selected on the NAV, the associated VORTAC or VOR-DME station frequency will also be selected automatically.

All controls for the King KN-53 are mounted on the front panel of the receiver. Control lighting is provided by the instrument panel flood lighting system. Operation and description of the audio control panel used in conjunction with this radio are shown and described in Supplement 26 in Section 9 of this handbook.

SECTION 2 LIMITATIONS

There is no change to the airplane limitations when this avionics equipment is installed.

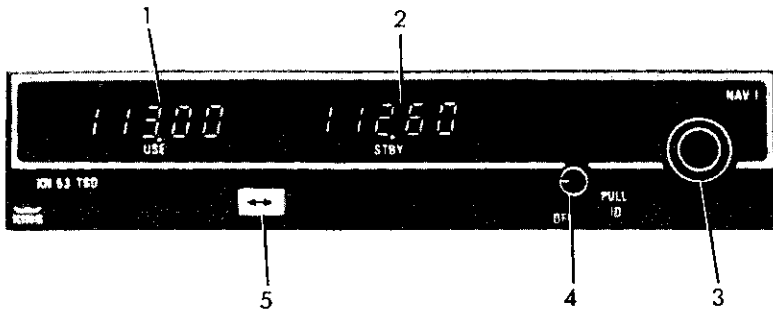
SECTION 3 EMERGENCY PROCEDURES

There is no change to the airplane emergency procedures when this avionics equipment is installed. However, if the frequency readouts fail, the radio will remain operational on the last frequency selected. The frequency control should not be moved due to the difficulty of obtaining a known frequency under this condition.

SECTION 4 NORMAL PROCEDURES

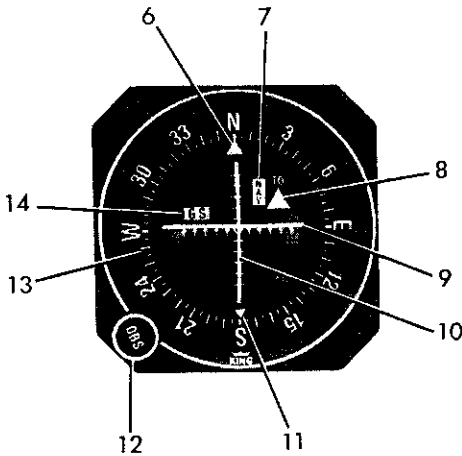
NORMAL OPERATION

1. ON/OFF/VOL/IDENT Control -- TURN clockwise until radio comes on.
2. SPEAKER/PHONE Selector Buttons (on audio control panel) -- SET to this radio.
3. ON/OFF/VOL/IDENT Control -- PULL out and adjust to desired audio level.
4. Frequency Selector Knobs -- SELECT desired operating frequency.
5. Frequency Transfer Button (← →) -- PRESS to transfer desired frequency from the "STBY" display into the "USE" display.



1. OPERATING FREQUENCY DISPLAY (USE) - Displays ACTIVE navigation frequency.
2. STANDBY FREQUENCY DISPLAY (STBY) - Displays STANDBY navigation frequency.
3. FREQUENCY SELECTOR KNOBS - The larger selector knob is used to change the MHz portion of the frequency display; the smaller knob changes the kHz portion in 50-kHz steps. At either band edge of the 108.00 to 117.95 MHz frequency spectrum, an off-scale rotation will wrap the display around to the other frequency band-edge (i.e., 117.95 advances to 108.95 with MHz knob rotation, or 117.00 with kHz knob rotation). DME and optional internal glideslope channeling are also controlled by these selector knobs.
4. ON/OFF/VOL/IDENT Control - Rotate the knob clockwise from the detented "OFF" position. Power will be activated and the unit will be ready to operate. No warm up time is required. Rotation of this control also adjusts NAV signal volume. NAV voice may be heard when the knob is pushed in. When the knob is pulled out, the Ident signal plus voice may be heard.
5. FREQUENCY TRANSFER BUTTON (↔) - Interchanges the frequencies in the USE and STANDBY displays.

Figure 1. King Navigation Receiver (Type KN-53)
(Sheet 1 of 2)



6. COURSE INDEX - Indicates selected VOR course.
7. NAVIGATION FLAG (NAV) - When visible, red NAV flag indicates unreliable VOR/LOC signals or improperly operating equipment. Flag disappears when a reliable VOR/LOC signal is being received.
8. TO-FROM INDICATOR - Operates only with a VOR signal. With usable VOR signal, indicates whether selected course is "TO" or "FROM" station. With usable localizer signal the indicator is not in view.
9. GLIDESLOPE DEVIATION NEEDLE - Indicates deviation from ILS glideslope.
10. COURSE DEVIATION POINTER - Indicates course deviation from selected omni course or localizer centerline.
11. RECIPROCAL COURSE INDEX - Indicates reciprocal of selected VOR course.
12. OMNI BEARING SELECTOR (OBS) - Rotates OBS course card to select desired course.
13. OBS COURSE CARD - Indicates selected VOR course under course index.
14. GLIDESLOPE FLAG (GS) - When visible, red GS flag indicates unreliable glideslope signal or improperly operating equipment. Flag disappears when a reliable glideslope signal is being received.

Figure 1. King Navigation Receiver (Type KN-53)
(Sheet 2 of 2)

**SECTION 5
PERFORMANCE**

There is no change to the airplane performance when this avionic equipment is installed. However, the installation of an externally-mounted antenna or several related external antennas, will result in a minor reduction in cruise performance.

—

—

SUPPLEMENT COLLINS HF COMMUNICATION SYSTEM

(Type HF-230)

SECTION 1

GENERAL

The Collins HF-230 High Frequency Communication System, shown in Figure 1, consists of a panel-mounted CTL-230 Control, TLR-230 Transceiver (100 watts), PWR-230 Power Amplifier and accessory AAC-230 Automatic Antenna Coupler.

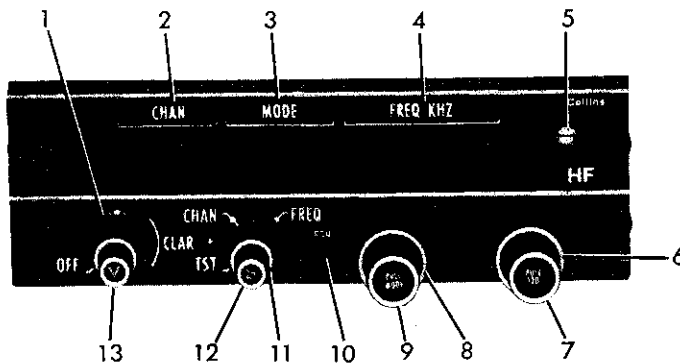
The HF-230 system provides operation on any one of 280,000 pilot-selected discrete channels within the 2.0000 to 29.9999 MHz frequency range (frequency spacing is 100 Hz) for simplex operation. In addition, the HF-230 provides 176 preprogrammed International Telecommunications Union (ITU) channels for half-duplex operation and 40 user programmed channels that can be programmed for either simplex or half-duplex operation throughout the range.

The HF-230 system can transmit and receive using upper (USB) or lower (LSB) sideband (A3J); split-channel, reduced-carrier telephone mode (TEL PLT CAR) (A3A); split-channel, suppressed-carrier telephone mode (TEL SUP CAR) (A3J); and compatible AM (A3H).

All controls for the Collins HF-230 system are mounted on the front panel of the CTL-230 control. The control provides automatic display dimming or may be remotely dimmed by a dimming control. Operation and description of the HF transceiver is shown and described in Figure 1. Operation and description of the audio control panel used in conjunction with this radio are shown and described in Supplement 26 in Section 9 of this handbook.

SECTION 2 LIMITATIONS

There is no change to the airplane limitations when this avionic equipment is installed.



1. CLARIFIER KNOB (OUTER CONCENTRIC KNOB) - When rotated from off position, the clarifier control adjusts the receiver frequency in SSB operation to improve the speech quality received. The clarifier knob is unique to SSB operation and is not used in AM operation. The clarifier is disabled on transmit.
2. CHANNEL DISPLAY (CHAN) - Displays selected channel number in the CHAN mode, or dashes (---) in the FREQ mode.
3. MODE DISPLAY - Displays operating mode of the HF-230 system (USB, LSB, AM, TEL SUP CAR or TEL PLT CAR).
4. FREQ KHZ DISPLAY - Displays operating frequency and receive (R) and transmit (T) annunciators. Operating frequency is displayed in both CHAN and FREQ modes.
5. PHOTOCCELL - Dims display automatically.
6. 10kHz CONTROL (OUTER CONCENTRIC KNOB) - May be rotated to (1) change channels or (2) change the 10-kHz digit under the cursor in the frequency display. In order to change channels, the CHAN/FREQ switch must be in the CHAN position. Prior to changing frequency, the CHAN/FREQ switch must be in the FREQ position.

Figure 1. Collins High Frequency Communicator
(Type HF-230) (Sheet 1 of 2)

7. 100 Hz/1 kHz CONTROL (INNER CONCENTRIC KNOB) (PULL 100) - In **FREQ** mode and with the knob pushed in, this control changes the 1-kHz digit in the frequency display. With the knob pulled out, this control changes the 100-Hz digit in the display.
8. 1 MHz CONTROL (OUTER CONCENTRIC KNOB) - In **FREQ** mode, this control changes the 1-MHz digit in the **FREQ** mode and the 100's and 1000's digits in the **CHAN** mode.
9. **MODE/100 kHz CONTROL (INNER CONCENTRIC KNOB) (PULL MODE)** - In the "in" position, this control selects the 100-kHz digit in the frequency display when the **FREQ/CHAN** switch is in the **FREQ** position. It has no function in the **CHAN** position. In the "out" position, this control is used to select the transmit and receive mode of operation. The modes available depend on whether the system is operating with a discrete frequency selected, one of the 176 preprogrammed ITU channels selected, or one of the 40 user programmable channels selected.
10. **PROGRAM BUTTON (PGM)** - Used when programming the 40 user channels. The **CHAN/FREQ** switch must be in **CHAN** position.
11. **CHANNEL/FREQUENCY SWITCH (CHAN/FREQ) (OUTER CONCENTRIC KNOB)** - Controls method of frequency selection. In the **FREQ** mode, any of the 280,000 available frequencies between 2.0 and 29.9999 MHz may be selected in 100-Hz steps with the frequency select knobs, and **USB**, **LSB** or **AM** mode can be used. In the **CHAN** mode, the frequency select knobs select ITU and user programmed channels by their channel numbers.
12. **SQUELCH CONTROL** - Adjusts to mute undesired background noise. The proper squelch setting is made by rotating the S-knob (squelch) clockwise from the **TST** (test) position until background noise can be heard and then turning it counterclockwise until the background noise disappears or is just barely audible. When the S-knob is in the **TST** position, the squelch circuit is, in effect, removed from the receiver audio circuits. In the **TST** position, maximum background noise (depending on the volume control setting) will be heard.
13. **OFF/VOLUME (OFF/V)** - Controls application of primary power to the entire system and varies the audio gain.

Figure 1. Collins High Frequency Communicaton
(Type HF-230) (Sheet 2 of 2)

SECTION 3

EMERGENCY PROCEDURES

There is no change to the airplane emergency procedures when this avionic equipment is installed.

INTERNATIONAL DISTRESS FREQUENCY. The frequency 2182 kHz on USB emission mode has been designated as an International Distress Frequency. It is monitored worldwide and should be used only in the case of an actual emergency. If repeated calls on 2182 kHz do not bring a response, the flight crew may wish to try the U.S. Coast Guard on the following channels:

USCG CHANNELS/FREQUENCIES (USB emission mode)

| ITU Channel No. | Aircraft Receive (kHz) | Aircraft Transmit (kHz) |
|--------------------|---------------------------|----------------------------|
| 424 | 4428.7 | 4134.3 |
| 601 | 6506.4 | 6200.0 |
| 816 | 8765.4 | 8241.5 |
| 1205 | 13113.2 | 12342.4 |
| 1625 | 17307.3 | 16534.4 |

If the Coast Guard cannot be contacted on one of these channels/frequencies, try a maritime radiotelephone (public correspondence) operator channel.

SECTION 4 NORMAL PROCEDURES

PREFLIGHT INSPECTION:

WARNING

WHEN PERFORMING AN HF-230 RADIO CHECK ON THE GROUND, MAKE CERTAIN THAT ALL PERSONNEL ARE CLEAR OF THE HF ANTENNA BEFORE TRANSMITTING. SERIOUS RF BURNS CAN RESULT FROM DIRECT CONTACT WITH THE ANTENNA OR ANTENNA TERMINAL WHEN THE SYSTEM IS TRANSMITTING.

1. Antenna -- CHECK structural integrity.
2. MIC (Microphone) Selector Switch (on audio control panel) -- SELECT HF position.
3. HF SPEAKER/PHONE Selector Buttons (on audio control panel) -- PRESS desired mode.
4. OFF/VOLUME Control Knob -- TURN ON. Allow 15-minute warmup (time for frequency standard to stabilize).
5. Authorized Channel or Frequency -- SELECT.
6. Microphone Button -- PRESS momentarily. The antenna coupler will tune automatically and a steady tone will be heard during the tuning cycle. Normal tuning cycle requires 5 to 10 seconds. Within one second after completion of antenna coupler tuning cycle, the tone will cease, indicating that the system is ready for use.
7. Radio Check -- TRANSMIT and RECEIVE on usable frequency.

NOTE

If the HF-230 detects a fault during the tuning of the antenna after 30 seconds, the tone will begin to "beep" indicating that a fault has occurred, in which case, simply key the microphone and the automatic antenna coupler will begin a new tuning cycle to clear the fault. If repeated antenna tuning cycles fail to clear the fault there is probably an equipment malfunction. If practical, attempt to retune the antenna on an alternate frequency. If "R" or "T" annunciators flash, this indicates a possible equipment malfunction.

CHANNEL PROGRAMMING:

NOTE

Half-duplex operation uses one frequency for receiving and a separate frequency for transmitting. Simplex operation uses same receive and transmit frequency.

1. MIC (Microphone) Selector Switch (on audio control panel) -- SELECT HF position.
2. HF SPEAKER/PHONE Selector Buttons (on audio control panel) -- PRESS desired mode.
3. OFF/VOLUME Control Knob -- TURN ON.
4. CHAN/FREQ Switch -- Rotate to CHAN position.
5. Left Channel Outer Concentric Knob -- ROTATE in either direction until user channel 1 or 40 appears at the right side of the CHAN display. Then use the right outer concentric knob to select the desired channel number (from 1 to 40) to be programmed.
6. PGM Button -- PRESS once to initiate the programming sequence. At this point, the entire display on the CTL-230 will begin to slowly blink.
7. Four Frequency Select Knobs -- ROTATE. The receive frequency will appear in the FREQ KHZ display. Next, select the desired operating mode (USB, LSB, AM, TEL SUP CAR, or TEL PLT CAR) by pulling out on the PULL MODE knob and rotating it until the appropriate mode appears in the MODE display.
8. PGM Button -- PRESS to store data. The display will blank for a short period of time to confirm storage.

NOTE

- When the display returns, it will be blinking faster with the transmit frequency displayed. If no changes are made within 20 seconds, the currently displayed transmit frequency will become invalid and a receive-only channel will be created. Repeat Steps 7 and 8 for desired transmit frequencies.
 - If additional user channels are to be programmed for half-duplex operation, repeat Steps 5 thru 8.
9. Microphone Button -- PRESS momentarily to initiate the antenna coupler turning cycle.

10. Volume (V) and Squelch (S) Controls -- ADJUST as desired.

NOTE

- In half-duplex operation, the mode that is selected (USB, LSB, AM, TEL SUP CAR, or TEL PLT CAR) will always control both the receive and the transmit frequencies. The receive frequency is shown in the **FREQ KHZ** display and annunciated by the letter **R** (at the right side of the **FREQ KHZ** display) until the mic is keyed, at which time the transmit frequency is displayed and annunciated by the letter **T**. If the receive (**R**) or transmit (**T**) annunciators on the **CTL-230** flash, this indicates that the receive or transmit (as applicable) frequency data from the **TCR-230** does not match that being sent by the **CTL-230**. An equipment malfunction is probable and the system should be checked by maintenance personnel.
- In simplex operation, the receive and transmit frequencies are identical. The receive frequency is shown in the **FREQ KHZ** display and annunciated by the letter **R** (at the right side of the **FREQ KHZ** display) until the mic is keyed, at which time the frequency remains unchanged but the **R** annunciator changes to a **T** to indicate that the system is transmitting. If the receiver (**R**) or transmit (**T**) annunciators on the **CTL-230** flash, this indicates that the receive or transmit (as applicable) frequency data from the **TCR-230** does not match that being sent by the **CTL-230**. An equipment malfunction is probable and the system should be checked by maintenance personnel.

NORMAL OPERATION:**WARNING**

WHEN PERFORMING AN HF-230 RADIO CHECK ON THE GROUND, MAKE CERTAIN THAT ALL PERSONNEL ARE CLEAR OF THE HF ANTENNA BEFORE TRANSMITTING. SERIOUS RF BURNS CAN RESULT FROM DIRECT CONTACT WITH THE ANTENNA OR ANTENNA TERMINAL WHEN THE SYSTEM IS TRANSMITTING.

1. Preflight -- COMPLETE.
2. MIC (Microphone) Selector Switch (on audio control panel) -- SELECT HF position.
3. HF SPEAKER/PHONE Selector Buttons (on audio control panel) -- PRESS desired mode.

4. OFF/VOLUME Control Knob -- TURN ON. Allow 15-minute warmup (time for frequency standard to stabilize).
5. CHAN/FREQ Switch -- Select FREQ or CHAN mode.

DIRECT TUNING:

- a. Frequency Control Knobs -- ROTATE to set desired frequency.
- b. MODE Control -- PULL and ROTATE until desired mode is announced.

CHANNEL OPERATION:

- a. PULL MODE (Left concentric knob) -- PULL and ROTATE to select desired channel number.
6. Microphone Button -- PRESS momentarily. The antenna coupler will tune automatically and a steady tone will be heard during the turning cycle. Normal tuning cycle requires 5 to 10 seconds. Within one second after completion of antenna coupler tuning cycle, the tone will cease, indicating that the system is ready for use.
7. OFF VOLUME Knob -- SET to desired volume level.
8. SQUELCH Knob -- ROTATE S-control slowly clockwise until receive noise just disappears.

NOTE

Do not rotate S-control too fast. The squelch circuit has a relatively long time constant and rotating the knob too far may result in missed calls on some of the weaker signals.

9. CLARIFIER Knob -- ROTATE to optimize incoming SSB signal quality.

NOTE

Whenever a different channel is selected, the antenna coupler automatically returns to the home position. This leaves the antenna untuned to the new channel, reducing the sensitivity of the receiver. To avoid any missed calls or poor reception, it is recommended that the ptt button be pressed momentarily to initiate an antenna coupler tune cycle for the new channel (before pressing the ptt button, verify that the channel is clear). The antenna will then be tuned and the system is now ready for immediate use.

OPERATIONAL NOTES:**HF SSB COMMUNICATIONS:**

1. Most all aircraft HF SSB communications are conducted in USB mode. Some ground stations continue to use the AM mode, but these stations are being phased out in favor of the more efficient SSB mode of operation.

SIMPLEX OPERATION:

1. In simplex operation, the emission mode you select (USB or AM) will always control both receive and transmit frequencies. Also the receive frequency is displayed until the mic is keyed, at which time the transmit frequency is displayed.

SELECTING FREQUENCIES:

1. The higher frequencies are best during daylight (10,000.0 to 29,999.9 kHz) and the lower frequencies work best at night (2000.0 to 10,000.0 kHz).

RETUNING THE ANTENNA COUPLER:

1. It is necessary to retune the antenna coupler whenever the MODE selector knob is changed from one mode to another. Pressing the MIC button momentarily initiates antenna tuning.

SECTION 5

PERFORMANCE

There is no change to the airplane performance when this avionic equipment is installed. However, the installation of an externally-mounted antenna or several related external antennas will result in a minor reduction in cruise performance.

—

—

A

Abbreviations, Symbols
and Terminology 1-11

Accelerate Go Distance
Chart 5-44

ADF, King 9-2

After Landing 4-12,4-35

Aileron System 7-6

Air Conditioning Systems . . . 9-1

Airframe 7-5

Airplane Inspection Periods . 8-5

 Cessna Continuous Inspection
 Program 8-5

 Cessna Customer Care
 Program 8-6

 Propjet CESCO System . 8-6

 Engine Condition Trend
 Monitoring 8-6

 Servicing Requirements . . 8-8

 Airplane File 8-9

Airplane Performance
 Terminology 1-16

Airplane Weighing Form . . . 6-9

Airspeed Calibration Chart . 5-17

Airspeed for Emergency
 Operations 3-5,3-27

Airspeed Indicator Markings . 2-6

Airspeed Limitations 2-4

Airspeed Terminology 1-11

Airstart 3-8,3-35

Alcohol Windshield
 Deice System 9-1

Altimeter Correction Chart . 5-18

Altimeter, Encoding . . . 3-24,3-62

Altitude Encoding/
 Alerting/Preselect 9-1

Altitude Limit 2-16

Annunciator Panel 7-15

Area Navigation System . . 9-1,9-2

Audio Control Panel 7-80

Audio Control Panel, King . . 9-2

Automatic

 Direction Finder 7-90

Avionics Bus Failure . . . 3-23,3-61

Avionics Systems 4-40,7-79

 Audio Control Panel,
 1000 7-80

 Automatic Direction Finder,
 400 7-90

 Avionics Interference . . . 7-80

 Avionics Master Switches . 7-80

 Glideslope, 400 7-88

 Locator Beacon 7-85

 Marker Beacon, 400 7-85

 Nav/Com, 400 7-92

B

Baggage, Cabin and
 Entry Dimensions 1-9

Baggage Compartments . . . 7-28

Battery 7-58

Balked Landing 4-11,4-34

Beacon, Locator 7-85

Before Engine Starting . . 4-7,4-17

Before Landing 4-11,4-32

Before Takeoff 4-9,4-25

Before Taxiing 4-9,4-23

Bleed Air System 7-66

Brake System 7-57

Bus Failure, Avionics . . . 3-23,3-61

C

Cabin Air System 7-68

Cabin, Baggage and
 Entry Dimensions 1-9

Cabin Door Not
 Secured 3-23,3-61

Cabin Features . 7-99 (7-100 blank)

 Cabin Fire Extinguisher
 7-99 (7-100 blank)

Center-of-Gravity Limits . . 2-13

- Center-of-Gravity Limits
Envelope Graph 6-16
- Cleaning and Care 8-28
Exterior Cleaning 8-28
Interior Care 8-31
- Climb 4-10,4-28
- Climb Gradient at
V₂ - One Engine
Inoperative Graph 5-42
- Cold Weather Operation 4-38
- Comm, King 9-2
- Conservation, Fuel 4-50
- Control Locks 7-34
- Crew Door Not Secured 3-23, 3-61
- Crew Limits, Flight 2-13
- Cruise 4-10,4-30
- D**
- Deice Boot System 9-1
- Descent 4-11,4-31
- Descent, Emergency 3-12,3-41
- Digital Clock, Davtron 9-1
- Dimensions, Cabin,
Baggage and Entry 1-9
- Distance Measuring
Equipment 9-1
- Ditching 3-16,3-49
- DME, King 9-2
- Door Not Secured,
Cabin 3-23,3-61
- Doors, Windows and Exits 7-31
Cabin Door 7-31
Emergency Exit Window 7-33
Windows 7-33
- E**
- Electrical
System 3-18,3-52,7-57
AC Power 7-62
Battery 7-58
- Battery and Generator
Switches 7-58
- Circuit Breakers, Switch
Breakers and Fuses 7-59
- External Power
Receptacle 7-62
- Generator Control Units 7-59
- Spare Fuses 7-59
- Voltmeter and
Ammeters 7-59
- Electrical Elevator
Trim 7-99 (7-100 blank)
- Electrical Windshield
Anti-ice 9-1
- Elevator System 7-8
- ELT, Postflight 4-12,4-36
- Emergency Descent 3-12,3-41
- Emergency Exit 3-23,3-61
- Emergency
Information 3-65 (3-66 blank)
- Emergency Procedures
Abbreviated Checklist 3-6
Amplified Checklist 3-27
- Encoding
Altimeter 3-24,3-62,9-1
- Endurance Profile Graph 5-100
- Engine Bleed Air System 7-66
- Engine Clearing Procedures 4-22
- Engine Controls
Terminology 1-15
- Engine Failure 3-6,3-29
- Engines 1-4,7-34
Air Induction System 7-40
Cowl Flaps 7-42
Clearing Procedures 4-22
Engine Accessories 7-42
Engine Break-in
Procedures 7-39
- Engine Controls 7-35
- Engine Controls
Terminology 1-15
- Engine Instruments 7-38
- Engine Oil System 7-39

Engine Shock Mounts . . . 7-46
 Exhaust System 7-40
 Fire Detection and
 Extinguishing System . . . 7-46
 Ignition Procedures 4-22
 Ignition System 7-39
 Starting System 7-42
 Engine, Before Starting . . 4-7,4-17
 Engine Securing
 Procedure 3-8,3-35
 Engine, Starting 4-8,4-19
 Entry, Cabin
 and Baggage Dimensions . . 1-9
 Environmental
 System 3-21,3-57,4-12,4-36
 Equipment List 6-19 (6-20 blank)
 Exits, Doors and Windows . . 7-31

F

Fire and Smoke 3-10,3-38
 Fire Detections and
 Extinguishing System . . . 4-37
 Fire, Engine 3-10,3-38
 Flap System 7-21
 Flaps, Retracted
 Landing 3-15,3-47
 Flight Controls 7-5
 Aileron System 7-6
 Aileron Trim System 7-7
 Elevator System 7-8
 Elevator Trim System 7-9
 Rudder System 7-10
 Rudder Trim System 7-11
 Flight Control System 9-1
 Flight Crew Limits 2-13
 Flight In Icing Conditions . . 9-1
 Flight Instruments 7-19
 Flight Load Factor Limits . . 2-13
 Flight Planning Terminology 1-16
 Fuel 1-5
 Fuel Conservation 4-50
 Fuel Limitations 2-16

Fuel System 3-17,3-49
 Boost Pumps 7-49
 Crossfeed System 7-53
 Drain Valves 7-49
 Engine Fuel System 7-54
 Firewall Shutoff Valve
 Switches 7-54
 Fuel Flow Gages 7-54
 Fuel Indicating System . . 7-49
 Fuel Level Low Warning
 Lights 7-54
 Fuel Quantity Gage 7-54
 Fuel Tanks 7-48
 Vent System 7-53
 Fuses, Spare 7-59

G

Glide 3-12,3-42
 Glideslope 7-88
 Go-Around, Engine
 Inoperative 3-16,3-48
 Ground Control 7-20
 Ground Handling 8-11
 Jacking and Leveling 8-13
 Parking 8-12
 Tie-Down 8-12
 Towing 8-11

H

Heating, Ventilating and
 Defrosting Systems
 4-13 (4-14 blank), 4-37,7-68
 Air Duct Overheat Switch 7-69
 Cabin Air Controls 7-69
 Cabin Air System 7-68
 Cabin Heat Controls 7-68
 Heating and Defrosting . . . 7-68
 Ventilating System 7-69
 HF Communication, Collins . . 9-2
 HF Transceiver, King 9-2
 Holding Time Graph 5-107

Horizontal Situation Indicator 9-1
 Hydraulic System 3-20,3-54,7-55

I

Icing Conditions, Flight in .. 9-1
 Icing Equipment 7-79
 Ice Protections System . 3-22,3-59
 Inspection Periods 8-5
 Instrument Markings .. 2-10,2-11
 Instrument Panel 7-14
 Instruments Terminology .. 1-15
 Integrated Flight
 Control System 9-1
 ISA Conversion and Operating
 Temperature Limits
 Graph 5-21

L

Landing, After 4-12,4-35
 Landing, Balked 4-11,4-34
 Landing, Before 4-11,4-32
 Landing Distance 5-104
 Landing Emergencies .. 3-12,3-43
 Landing Gear System 7-23
 Landing Gear Emergency
 Extension System ... 7-26
 Landing Gear Position
 Lights 7-25
 Landing Gear Shock
 Struts 7-26
 Landing Gear Warning
 Horn 7-25
 Lighting System 7-62
 External Lighting 7-62
 Internal Lighting 7-64
 Lights, Recognition 9-1
 Lights, Recognition Oscillating
 Beacon Ground 9-1
 Limitations 2-4
 Airspeed 2-4
 Altitude 2-16

Center-of-Gravity 2-13
 Crew 2-13
 Fuel 2-16
 Load Factor 2-13
 Maneuver 2-13
 Operational Equipment . 2-13
 Outside Air Temperature 2-16
 Passenger Seating 2-17
 Placards 2-18
 Powerplant 2-6
 Weight 2-11
 Load Factor Limits 2-13
 Loadings, Specific 1-11
 Locator 7-85
 Locator Transmitter
 Procedures 3-24,3-62
 Loss of
 Communication 3-25,3-63

M

Maneuvering Flight 4-38
 Maneuver Limits 2-13
 Marker Beacon 7-85
 Marker Beacon, King 9-2
 Maximum Certificated
 Weights 1-6
 Maximum Cruise Power
 Chart 5-50,5-58,5-66,5-74
 Maximum Cruise Power Fuel
 Required Graph 5-98
 Maximum Maneuvering
 Speeds 2-13
 Maximum Operating
 Altitude Limit 2-16
 Maximum Passenger
 Seating Limits 2-17
 Maximum Range Cruise
 Performance Chart .. 5-82,5-90
 Maximum Takeoff Weight
 To Achieve Takeoff
 Climb Requirements 5-26

Maximum Takeoff Weight
as Permitted by
Field Length Required . . . 5-28

Maximum Takeoff Weight
as determined by the
Demonstrated Brake
Energy Limits 5-31

Meteorological Terminology 1-13

Minimum Engine Torque Graph
for Takeoff 5-25

N

Navigation System 7-92

Navigation System 9-1,9-2

Night Flying 4-38

No Starter Assist 3-9,3-36

Noise Abatement 4-47

Normal Procedures
Abbreviated Checklist . . . 4-4
Amplified Checklist 4-15

Nosewheel Steering System 7-20

O

Oil 1-6

One Engine Inoperative
Takeoff Flight Path 5-6

Operation Equipment
Limits 2-13

Oscillating Beacon Ground

Recognition Lights 9-1
side Air
Temperature Limits 2-16

Overhead Console 7-14

Owner Advisories 8-7

Oxygen System
. 3-22,3-58,4-12,4-36,7-71

P

Passenger Seating Limits . . . 2-17

Performance Terminology . . 1-16

Pitot/Static Pressure System 7-73

Placards 2-18

Pneumatic System 7-73

Postflight ELT 4-12,4-36

Powerplant Instrument
Markings 2-10

Powerplant Limitations 2-6

Power Terminology 1-14

Preflight Inspections . . . 4-4,4-15

Pressure Conversion - Inches
of Mercury to Millibars
Graph 5-22

Preventive Maintenance that
may be accomplished by a
Certified Pilot 8-10

Procedures for Practice
Demonstration of V_{MCA} . . . 4-49

Prolonged Out-of-Service
Care 8-35

Propellers 1-4,7-46

Propeller
Synchrophaser 3-17,3-49

Publications 8-3

R

Radar, Weather 9-1

Radio Altimeter 9-1,9-2

Radio Magnetic Indicator 9-1,9-2

Range Profile Graph 5-99

Rate-of-Climb - All Engines
Operating 5-43,5-44

Rate-of-Climb - One Engine
Inoperative Graph 5-45

Rate-of-Climb - Balked Landing
Climb Graph 5-46

Recognition Lights 9-1

Rudder System 7-10

S

Sample Flight 5-7
 Sample Weight and Balance
 Form 6-17
 Seating Limits, Passenger .. 2-17
 Seats, Seat Belts and
 Shoulder Harnesses 7-30
 Passenger Provisions ... 7-30
 Pilot and Copilot
 Provisions 7-30
 Service Information Subscription
 Program 8-5
 Service Ceiling - One Engine
 Inoperative Graph 5-47
 Service Requirements 8-8
 Servicing 8-13
 Alcohol Windshield
 Deice Reservoir 8-22
 Cabin Fire Extinguisher . 8-14
 Flush Toilet Reservoir .. 8-22
 Fuel 8-14
 Fuel Additive 8-15
 Fuel Contamination 8-18
 Fuse and Fuse Limiter
 Replacement 8-21
 Landing Gear Hydraulic
 Reservoir 8-22
 Light Bulb Replacement . 8-23
 Oil 8-19
 Oxygen 8-21
 Tires 8-22
 Shutdown 4-12,4-35
 Smoke and Fire 3-10,3-38
 Spare Fuses 7-59
 Specific Loadings 1-11
 Spins 3-26,3-64
 Stall 4-37
 Stall Speeds Chart 5-23
 Stall Warning System 7-75
 Standard Airplane Weights .. 1-8
 Starting, Engine 4-8,4-19
 Starting, Before Engine . 4-7,4-17

Steering System, Nosewheel 7-20
 Symbols, Abbreviations
 and Terminology 1-11
 Systems Emergencies
 Avionics Bus
 Failure 3-23,3-61
 Cabin Door 3-23,3-61
 Crew Door 3-23,3-61
 Electrical 3-18,3-52
 Electric Elevator Trim
 Runway 3-25,3-64
 Emergency
 Exits 3-23,3-61
 Encoding Altimeter . 3-24,3-62
 Environmental 3-21,3-57
 Fuel 3-17,3-49
 Hydraulic 3-20,3-54
 Ice Protection 3-22,3-59
 Locator Beacon Rescue
 Procedures 3-24,3-62
 Nose Baggage Door Open
 on Takeoff 3-62
 Oxygen 3-22,3-58
 Propeller
 Synchrophaser ... 3-17,3-49
 Total Loss of
 Communications . 3-25,3-63
 Transponder
 Procedures 3-24,3-62

T

Takeoff 4-10,4-27
 Takeoff Distance Chart ... 5-32
 Takeoff, Before 4-9,4-25
 Taxiing 4-9,4-24
 Taxiing, Before 4-9,4-23
 Temperature Conversion from
 Fahrenheit to Celsius
 Graph 5-20

- Temperature Rise Due to Ram
 Recovery Graph 5-19
- Terminology, Symbols
 and Abbreviations 1-11
- Airspeed 1-11
- Engine 1-15
- Meteorological 1-13
- Performance 1-16
- Power 1-14
- Weight and Balance 1-17
- Three-View Drawing 1-2
- Time, Fuel and Distance
 to Climb Graph -
 Maximum Climb 5-48
- Time, Fuel and Distance
 to Climb Graph -
 Cruise Climb 5-49
- Time, Fuel and Distance to
 Descend Graph 5-102
- Transceiver, HF 9-1,9-2
- Transponder 9-1,9-2
- Transponder
 Procedures 3-24,3-62
- Trim Runaway,
 Electric Elevator 3-25,3-63
- Trim Systems
 Aileron 7-7
- Elevator 7-9
- Rudder 7-11
- Turbulent Conditions 3-12,3-41
- Weights, Standard Airplane 1-8
- Wind Component Graph 5-24
- Windows, Doors and Exits 7-31
- Wing Fire 3-10,3-38
- Wing Flaps System 7-21

W

- Weather Radar 9-1,9-2
- Weighing Procedures 6-3
- Weight and Balance 6-7
- Weight and Balance
 Record 6-7,6-18
- Weight Limits 2-11
- Weight and Moment Tables 6-10
- Weights, Maximum
 Certificated 1-6

3

3