

1. INTRODUCTION

Beginning in the Fall of 2000, an investigation was launched to deduce root cause of failures for roll trim relay failures on the Roll Trim Control board p/n 128-364122. Typical time-in-service for failed boards was 200-600 flight hours. The failure mode was a light “sticking” of relay contacts that would cause anomalous behavior of actuators during roll trim operations. In some cases, one of the two actuators would drive in one direction only. Repeated attempts by crew to operate or troubleshoot the system only served to drive one actuator in the same direction until it reached a mechanical limit. There were a few dual failures of relays that produced an uncontrollable motion of both trim actuators to their mechanical limits.

Relays used in this system are Mil-Spec, M83536/2-028M devices available from several suppliers. This report will describe an investigation, testing and development of a rationale for giving preference to one supplier (Magnecraft-Struthers-Dunn) based upon a demonstrated robustness advantage compared to then current supplier (Deutsch). This report will further describe less frequent but significant sticking of the preferred relay and the investigation that ultimately identifies root cause and a proposed change to the system design to fix the problem.

The troublesome relay is a “5-amp, crystal can” device that can be either socketed or soldered into the circuit. The original design inherited from Mitsubishi on the Diamond used soldered in, 10-amp relays. The relays were mounted in junction boxes on spacers and screws. At serial number RK-45, RK-49 and on, the larger, soldered in

relays were replaced with the smaller relays mounted on plug-in modules. There is no recorded history of sticking of the larger relays.

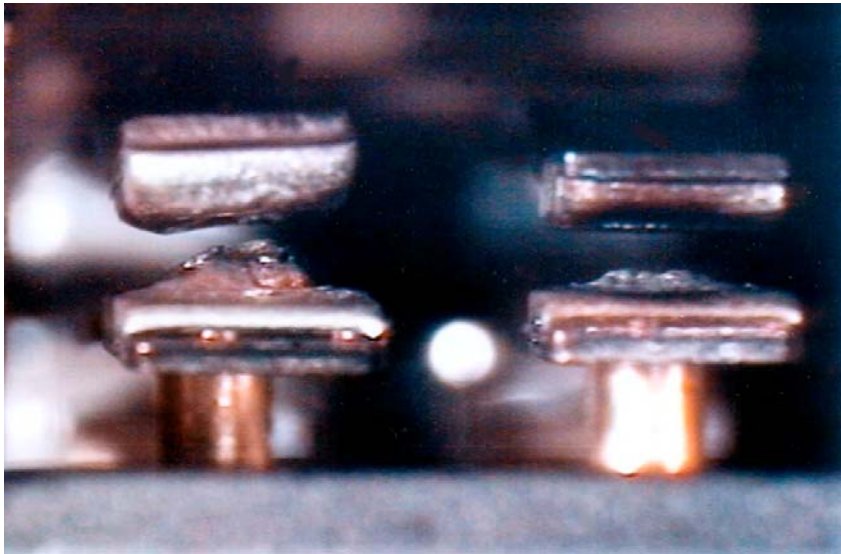

Troublesome relays were disassembled for microscopic inspection. Contact metal transfer was nominal for this application.

The adjacent photo illustrates contact condition after a life test of production relays by the present supplier (Deutsch). The manufacturer informed us that profound metal transfer illustrated in the photo is normal and typical of a relay that still meets requirements for life

testing at the factory.

Failed relays from the field were opened at RAC for inspection. Contact metal transfer in these devices was a small fraction of that illustrated here. The most affected contact had less than 5% of the surface area exhibiting any

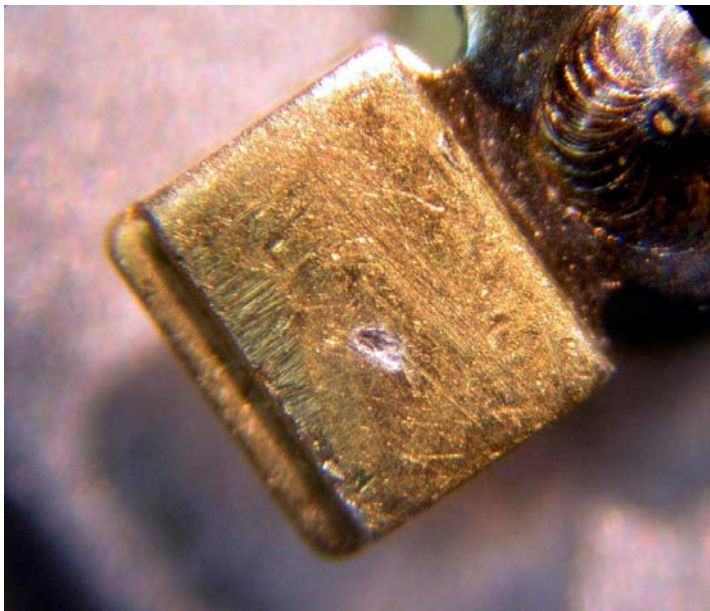

evidence of metal transfer. While metal transfer may participate in the sticking phenomenon being observed, the absolute magnitude of metal transfer is not a major clue as to root cause. Clearly these relays can continue to function within specified limits in spite of significant metal transfer. As a part of their QPL requirements, Deutch routinely demonstrates that the relay meets operating requirements in spite of metal transfer several times more severe than troublesome relays removed from the roll trim system.

The adjacent photo illustrates a relay contact that began to stick with fewer than 30,000 operating cycles and a very small area of contact wear.

The word “sticking” is used as opposed to “welding” because the fault has been demonstrated to spontaneously clear itself in

some cases. The fault always clears if the relay is moderately tapped. The small volume and area of contact damage considered with the very light sticking forces suggests that relay failure is a low-energy event.

2. INVESTIGATION

Boards returned from the field were tested on a production airplane. Each board repeated the squawk after a few trim events. In every case, a light tap to the board would cause the stuck relay to clear for a few cycles whereupon it would begin to stick again.

Studies of switching transients both on the bench and in the airplane were conducted to investigate stress on relay contacts in normal operation.

- Inrush currents measured during switching seldom exceed 6 amps and were typically 3-4 amps. The relays in question are tested for life with inrush currents on the order of 16 amps.
- Large RFI filter capacitors across the trim motors mitigate dv/dt effects during contact opening such that contact arcing during opening was reduced to levels too small to measure.
- New boards and “failed” boards from the field were tested on a new production airplane. In each case, boards returned from the field would duplicate the sticking phenomenon. In every case, detailed oscilloscopic investigation of voltages and currents impressed on sticking contacts revealed no extra ordinary stresses on the contacts.

2.1 Roll Trim System Simulator

A bench test fixture was fabricated to emulate the roll trim system in the aircraft. The fixture included exemplar wire types and lengths, RFI filters, center crossing detector switches, and a socket for Roll Trim Control board to be tested. An interface circuit provided a means for sending roll trim commands to the fixture from a supervisory computer. Fault monitoring circuits were included to halt the testing if a sticking of normally open contacts is detected.

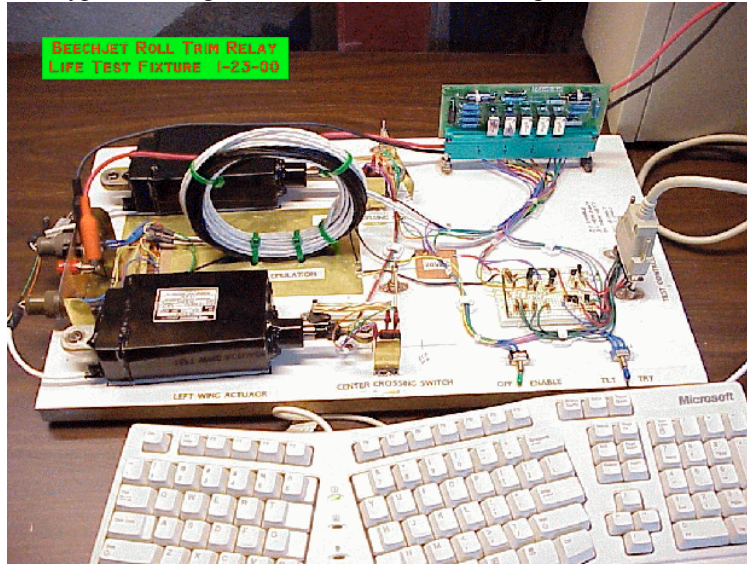

480 thousand cycles with no sticking.

2.2 Board Level Testing

A total of 4 roll trim boards were tested on the system simulator described above. One board was a field return populated with Deutsch relays. This board duplicated the sticking phenomenon in a few cycles (less than 200). Two new boards populated with Deutsch relays were tested. Both boards began to show the sticking phenomenon in 27-40 thousand cycles. A new board was populated with MSD relays. This board ran

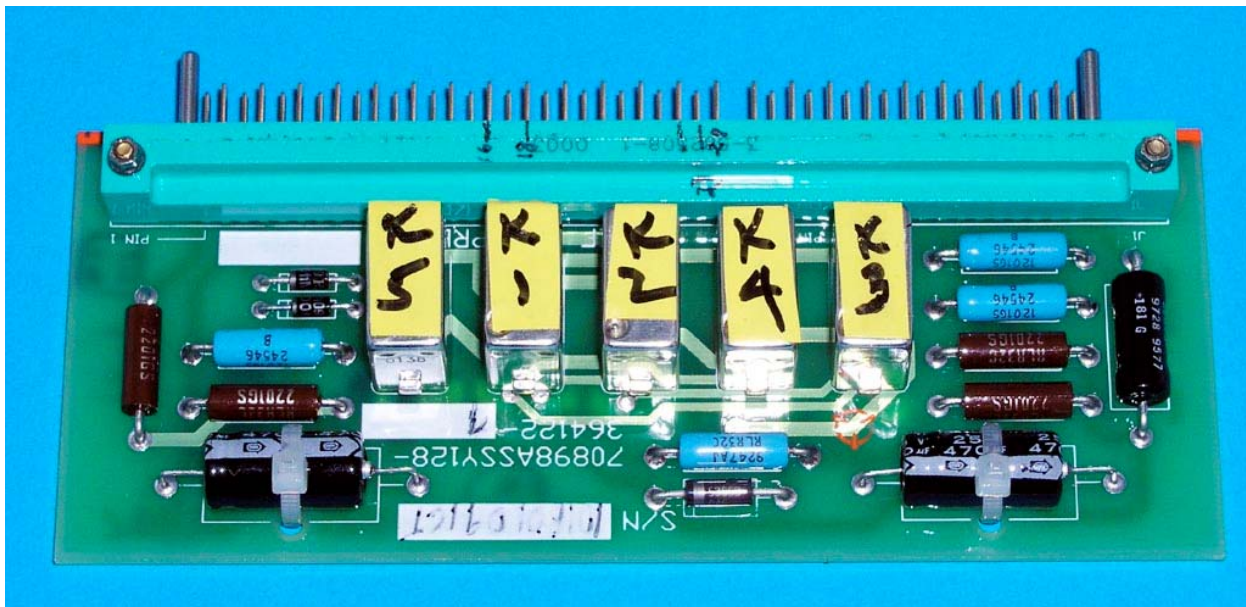

- Field failures of roll trim relays are attributable to low_force sticking of contacts in spite of the fact that electrical stresses on the relays are well inside the ratings envelope for the device.

- Roll Trim Control boards with a history of field problems readily repeated the failures when tested on and airplane and on the bench test fixture.
- New Roll Trim Control boards populated with present production relays produced by Deutch exhibited the same sticking phenomenon at 27K and 40K cycles respectively.
- A new Roll Trim Control board suffed with sample relays from Magnecraft-Struthers_Dunn relays completed 480K cycles with no failures.
- The ratio of cycles_to_failure versus failure_freecycles of the two brands of relays suggest that the MSD relays are a minimum of 12 times more robust than the Deutsch relays used in a similar system.

2.3 Component Level Testing

Additional studies were conducted in an effort to determine root cause of contact sticking in relays that were operating well within published limits. The original life test fixture described in the body of this report was crafted as a mock-up of the Beechjet's roll trim system including relays, wiring, filters and trim motors. There was a question in the writer's mind as to whether trim motors actually participated in the combination of stresses that precipitate a contact sticking event.

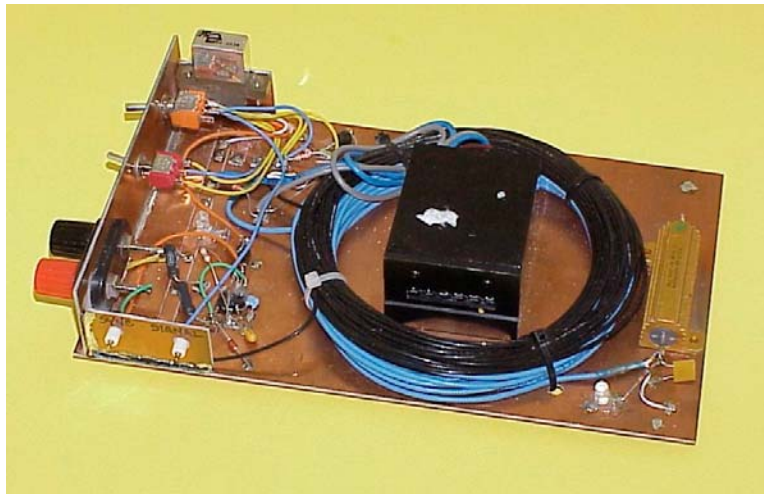

A “mini” fixture illustrated here (Schematic Appendix A, Figure A1) was crafted to . . .

- Cycle the relay under test at approximately 6 cycles per second.
- Replace the motor/actuator load with the equivalent resistive current load.
- Simulate the sum total of ship's wiring in the motor power path consisting of 30 feet of 20AWG power feed wire and 30 feet of shielded motor feed wiring.

Substitution of this fixture permitted more detailed studies of relay performance on an oscilloscope free of extraneous noises produced by a roll trim motor. The life-test fixture with actuators required approximately 10 hours of testing before anomalies could be expected to surface. The component level test fixture permitted a faster cycle rate such 30,000 or so cycles could be impressed on the unit under test in approximately 90 minutes. Proof of the test fixture performance involved cycling new Deutsch relays from stock until sticking was observed. More than a dozen stock relays were tested on this fixture. With few exceptions, contacts would begin to stick in the same 25 to 35 thousand cycles.

- Deutsch supplied several test articles with contacts having no gold plating. When cycled on the component level test fixture, the first test article began sticking at about 4,000 cycles. Subsequent testing on other contacts

revealed sticking characteristics not unlike the gold plated devices. The gold alloy solder hypothesis was disproved.

- The component level test fixture was used to demonstrate a substantial increase in robustness of other brands of relays as compared with Deutsch products.

Test studies and test results conducted through the fall of 2003 did not identify the physics of the contact sticking phenomenon. All products tested meet all of the requirements Mil-Spec QPL parts. Field experience and investigation shows that qualification tests do not demonstrate suitability of this product to every task bounded by the ratings envelope. The specification looks at contact resistance (very low energy levels) and endurance under maximum stress (5A load, 16A inrush). The roll trim system on Beechjet (0.3A load, 5A inrush) plus installation effects of wiring combine to craft an environment where the Deutsch product will not perform as well as other products tested. *A plant-wide/field-wide program was implemented to purge stocks of new Deutsch relays and to retrofit all fielded roll trim boards with new assemblies populated with MSD relays.*

2.4 Field Experience with MSD Relays

Late in 2003, RAC received several reports of trim problems involving new roll trim boards with MDS relays. Several field returns were tested on the system simulator and sticking relay faults were duplicated. In this case, we observed not only sticking of normally open contacts similar to past history with Deutsch relays, several instances of sticking normally closed contacts were observed.

The adjacent photo is typical of sticking contacts in relays returned from the field. The volume of transferred metal was very small with the contact showing no signs of electrical abuse.

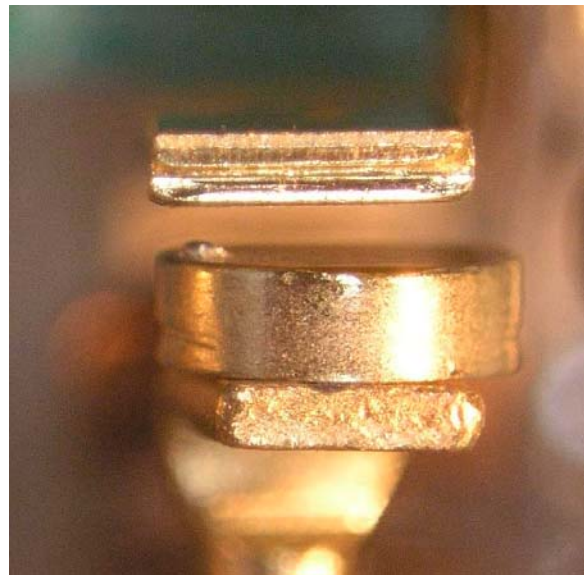

2.5 Contact Erosion / Circuit Effects Investigation

Contact sticking events with MSD relays in 2003 prompted further investigation into the effects of circuit constants on relay contacts. While the MSD product was less likely to stick in Beechjet's roll trim circuit, they were

demonstrably not immune from the phenomenon.. Further component level tests were conducted on Deutsch relays under three test conditions as follows:

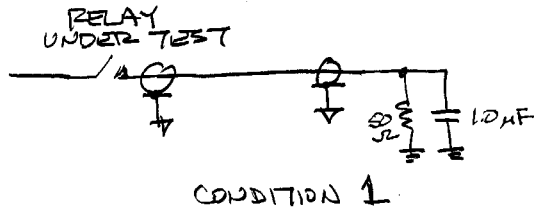

Condition 1. The first test condition is described in this sketch where all components emulating the aircraft configuration are in place: The first test article ran for 500K cycles on the section A contacts without sticking but metal transfer was spectacular.

This view shows footprint of the crater for moving contact of Section A. In spite of this remarkable metal transfer, the contact was still operating freely after 500K cycles.

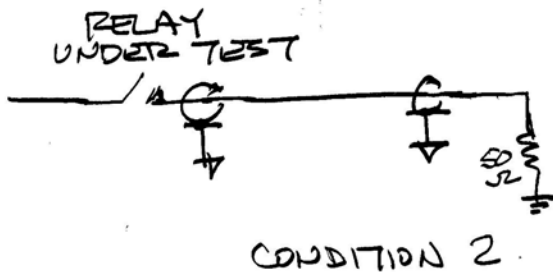
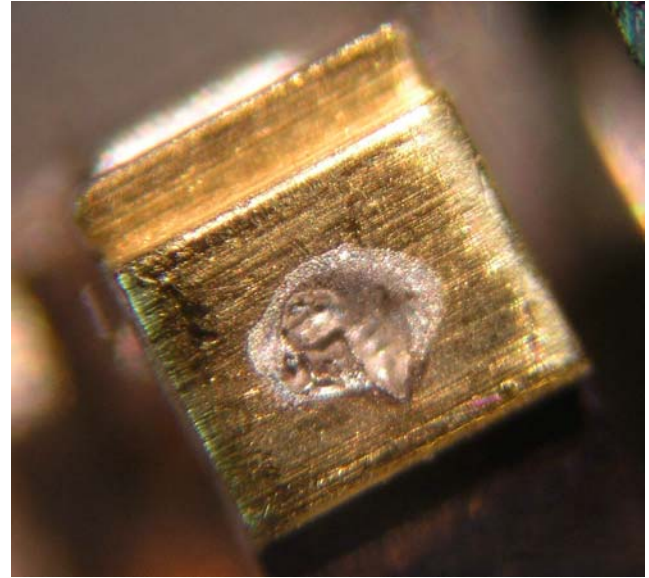

Condition 2 A second test article was run with the RFI filter capacitor removed.

This image is typical of both sections of the second test article after 500K cycles. No significant metal transfer. Both moving and stationary contacts showed a wide area of contact participation with little sign of erosion.

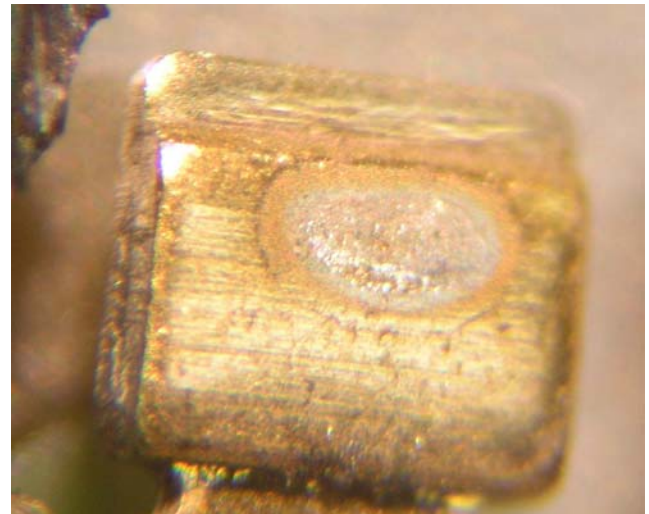

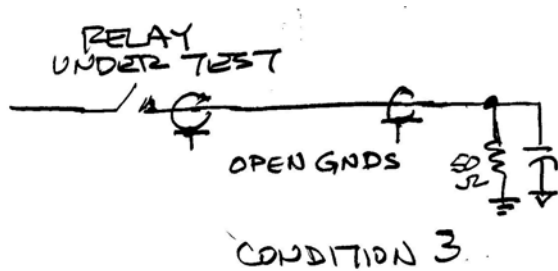

Condition 3. A third test article was tested with both load resistor and filter capacitor in place but with shield ground disconnected.

Section A ran 500K cycles without sticking. This view shows profile of the metal transfer pip on the stationary contact.

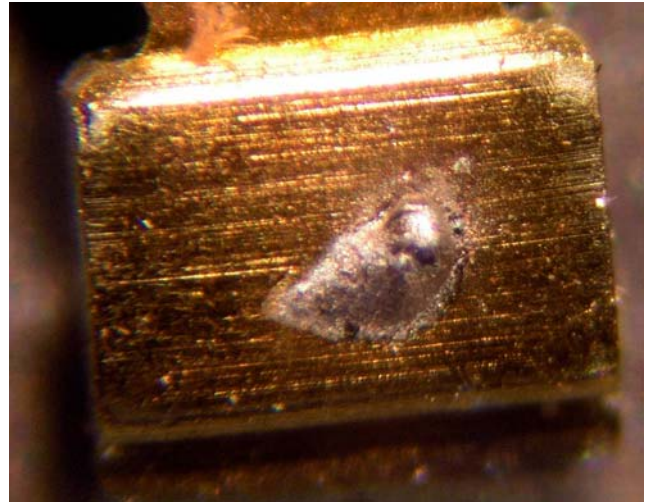

The tests were conducted over a small population of relays for which there is considerable randomness of wear effects. Data observed from these tests suggest the following correlations:

- The primary reactive effect responsible for contact erosion in this system is capacitive, not inductive.
- Major stresses are placed on the contacts during contact closure, not opening. This notion is reinforced by scope traces taken both on the bench and on the aircraft that revealed no voltage excursions characteristic of an inductive reaction.
- The shielded wire exacerbates contact erosion by almost an order of magnitude (30K cycles to sticking vs. 250-500K cycles with no sticking). The current working hypothesis is that the shielded wire behaves as a transmission line that reflects capacitive effects back to the relay contacts during contact bounce.
- The marked difference in performance between various brands of relays tested may well be most affected by contact dynamics during closing. Bounce characteristics are governed by combinations of spring rate, contact mass and closing velocities. Test articles with more bounce events will be more vulnerable to the combined effects of (a) pure shunt capacitance as a noise filter and (b) lengthy run of shielded wire between relay contacts and filter capacitor.

Based on what we know to date and absent any better conclusions I'll suggest there are two things we can do to improve relay life in Beechjet's roll trim system.

- Disconnect shield grounds for shielded wires running between roll trim relay board and the actuator location in wing.
- Define and install new configuration of RFI filter. The current filter is a 3-section, 1.0 uF capacitor that simply shunts the far of each shielded wire taking power to the trim actuator. It would be useful to:
 - Explore whether this filter is even needed.
 - If needed, is the current filter overly specified. A filter with lumped inductance and much smaller capacitors may do as well or better while offering a much lower capacitance effect on relay contacts.

2.6 Actuator Conducted Noise

On March 26, 2004, a roll trim actuator from the system simulator was tested for conducted emissions per DO-160, Curve M. Results of that test are illustrated in Appendix A, Figure A-2. Noise emissions from this actuator plotted at 15-20 db below the upper limit for the range 150 Khz to 3 Mhz. This preliminary test suggests that while the actuator's noise output is not zero, it's quite small compared to DO-160 limits without benefit of a noise filter.

2.7 Supporting Data From Another Study

During another investigation into contact failures on precision switches, the author had occasion to review Honeywell General Technical Bulletin #14, [Applying Precision Switches](#) authored by Honeywell-Microswitch. This document is available off the Internet at:

<http://content.honeywell.com/sensing/prodinfo/basicswitches/technical/010172.pdf>

Pages 16 through 19 of [Applying Precision Switches](#) speaks to sources and effects of contact resistance. The author explains that contact resistance is directly related to resistance of the controlled load. E.g.: contacts controlling high resistance, low current loads will exhibit a higher contact resistance than situations where the same contacts control higher current, low resistance loads. The same explanation speaks to softening and melting of surfaces on closed contacts.

Consider two spherical contacts just touching. Contact area between conductors is zero, and magnitude of electron flow between contacts has a high current density. Depending on voltage drop across the not-quite-optimum contact resistance, activity at molecular scale causes heating of the material that will soften if not melt the surface material. As the two surfaces become less-than-spherical, the flat spots generated allow contacts to move closer together, increasing contact area that reduces contact resistance. Temperatures drop below that required to induce surface deformation. It follows then that contact carrying higher current levels produce larger contact areas and decreased contact resistance.

This softening/melting phenomenon supports explanations of contact material transfer between contacts discussed in more detail on page 35. It also supports and explanation of contact "welding" or "sticking" on page 34. A section entitled "Closing the Circuit" on page 38 speaks to issue of contact bounce and metal transfer. It states that metal transfer can and does happen at ANY current level and that the condition can be exacerbated by contact bounce.

An experiment was conducted with failure-prone, Deutsch relays wherein a simple circuit was wired in series with contacts under test. The circuit consisted of a silicone controlled rectifier and time-delayed trigger circuit. The effect of this circuit is to delay loading of relay contacts until several milliseconds after they have become stable. This time delay completely masks the effects of contact bounce. The relay contact fitted with mitigation of inrush current showed very little switching effects after 300,000+ cycles in a circuit that has repeatedly demonstrated sticking and considerable metal transfer 30,000 cycles. Observer contact erosion was miniscule. Microscopic examination disclosed a small cluster of tiny mole-hills of contact metal. This experiment demonstrates that even when contacts are not electrically loaded until after bouncing has ceased, there is still some degree of metal transfer between contacts.

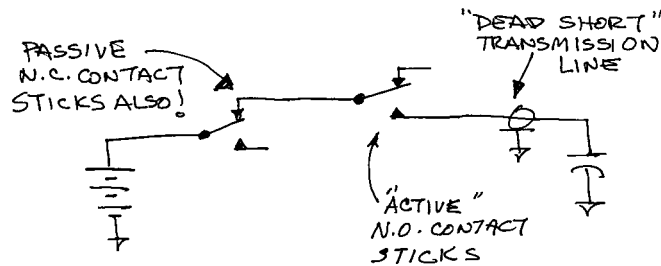

The softening/melting discussion offers an explanation for sticking noted in normally closed contacts for roll trim boards fitted with MSD relays. The normally closed contacts in this circuit close “dry”. I.e. not powered. It’s easy to visualize that if (1) the area of contact for a stationary pair of contacts is very low, and (2) if those contacts are in series with another pair of contacts subjected to the unique “sticking stresses” cited earlier, then stresses generated at moving contacts are shared by non-moving contacts. It’s not unreasonable to expect

that some sticking events could be experienced at both passive, normally-closed –AND- active, normally-open contacts.

2.8 Summary of Findings

- This style of relay is used in many applications across the full line of products at RAC. The fact that roll trim on the Beechjet experiences a high rate of “sticking” events is a strong indication that the roll trim circuit has characteristics unique to contact sticking.
- Experiments have demonstrated that minor variations of circuitry had a strong influence on probability of contact sticking.
- Older The MU-300 and older Beechjets (prior to RK45, RK49 and ON) used larger, 10A relays in this same circuit. No “sticking” events in roll trim have been reported in these aircraft.
- Switching brands of relays demonstrated a beneficial effect but does not address root cause of contact sticking.
- Three experiments have demonstrated modifications of the existing circuitry that mitigate if not eliminate the tendency to stick:
- Shielded wiring that runs from roll trim relay boards and roll trim actuators at the wing tips offers opportunity for transmission line effects. Energy transients launched into the wire can be reflected back to the source with a potential for exacerbating any tendencies for the contacts to stick.

- The noise filter capacitor is not necessary. DO-160 conducted emissions tests on a roll trim actuator show that noise generated by the motors in this product is sufficiently low to not require external filters.
- Adding electronic delays to the onset of contact switching current reduces contact wear to near zero and eliminates any tendency for contacts to stick in spite of effects of shielded wiring and filter capacitor cited above.
- An observation of test results from paragraph 2.5 Component Level Testing, Condition 2 is that after 500K cycles there was only microscopic pips of metal transfer spread over a wide area of the relay contact. In every other instance, contacts operated in the production roll trim circuit produce localized pips of metal transfer that concentrated contact erosion stresses in a small area thus driving up probability sticking by at least an order of magnitude.

3. Recommendations

The author is confident that any additional RFI/EMI testing of the Beechjet's roll trim actuators will confirm that the noise filter is not necessary for the system to meet operational requirements.

Based upon studies cited above a minimally intrusive solution to contact sticking problems in the Beechjet's roll trim system is to simply remove the existing noise filter. The Circuit Effects investigation demonstrated that removing the filter reduced contact wear to rates on a par with dry circuit switching of the same current levels.

Appendix A

Figures

- Figure A1 Schematic of Component Level Test Fixture
Figure A2 DO-160 Conducted Emissions Data for Roll Trim Acuator

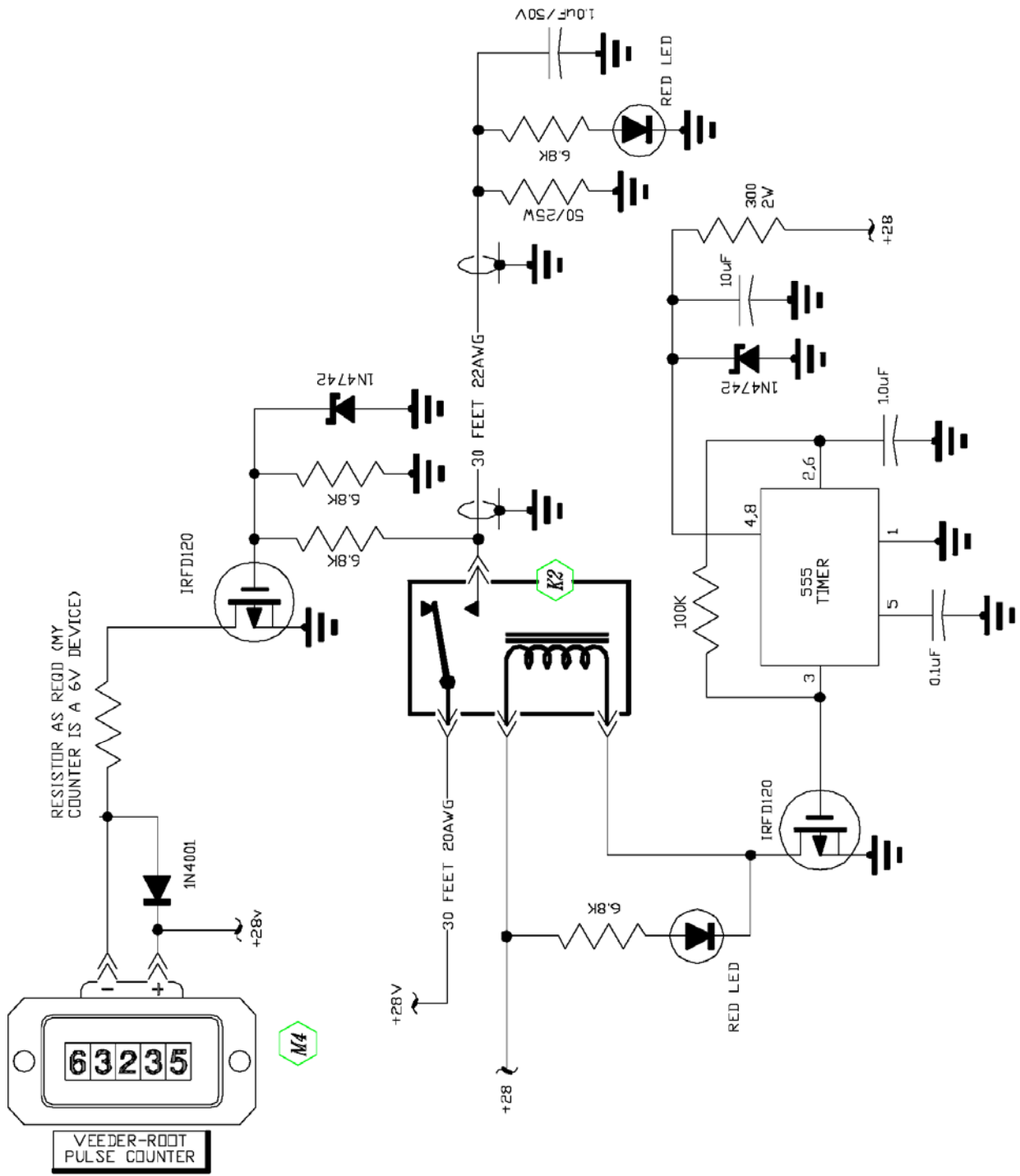

RAYTHEON
CONDUCTED EMISSIONS

EUT: 400A ROLL TRIM ACTUATOR
Manufacturer: SMITH
Operating Condition: No filter
Test Site: RAC
Operator: DON PHELPS
Test Specification: DO-160D (Informal Engineering Test)
Comment:

SCAN TABLE: "160D COND"

Short Description:			CONDUCTED EMISSIONS			
Start	Stop	Step	Detector	Meas. Time	IF Bandw.	Transducer
Frequency	Frequency	Width				
150.0 kHz	30.0 MHz	500.0 Hz	MaxPeak	50.0 ms	1 kHz	91550-1 Probe

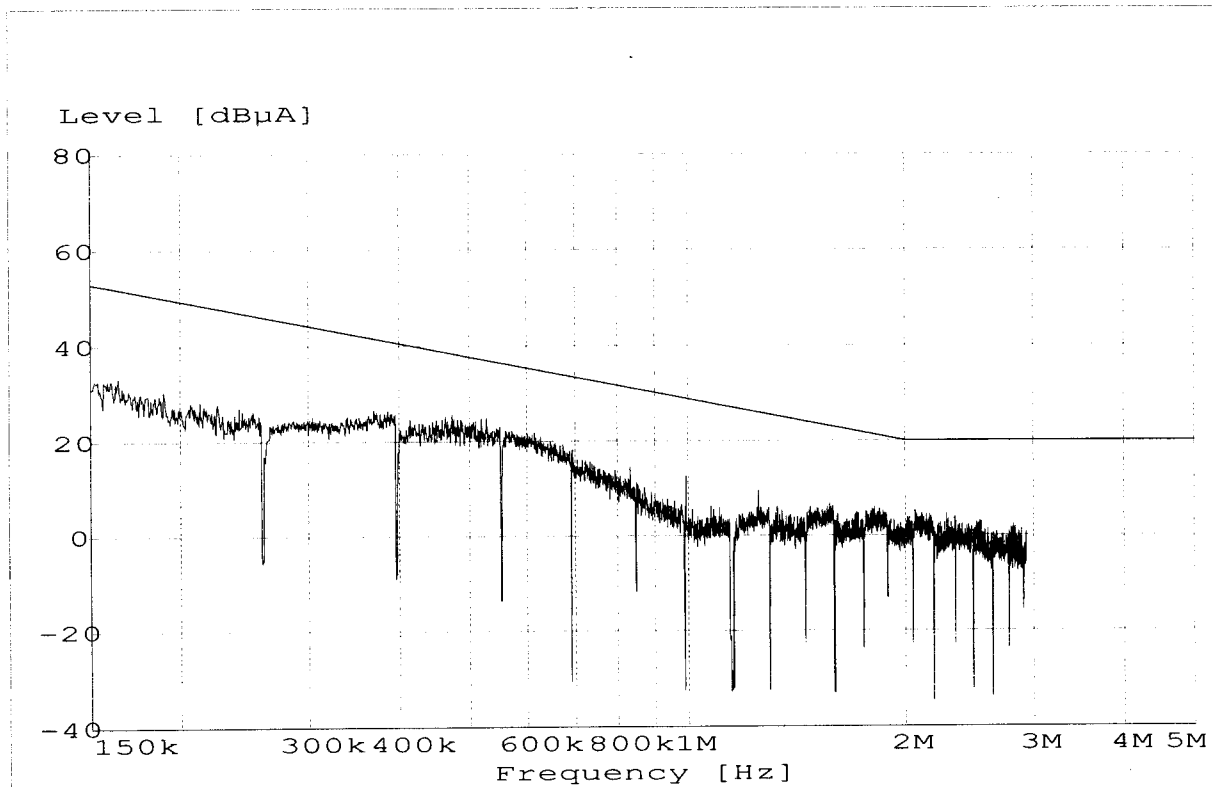

— MES 160D COND MaxPk
— LIM RTCA-COND-NB-Z&L-PL Cat M Power Leads